



SUNMARK
INSTRUMENTS

Mark Of Quality



NEUROSURGERY

www.sunmarkinstruments.com

Self-Retaining Brain Retractor
 Selbsthaltender Hirnretraktor
 Separador cerebral autostático
 Retracteur cérébrale autostatique
 Retratore celebrale autostatico

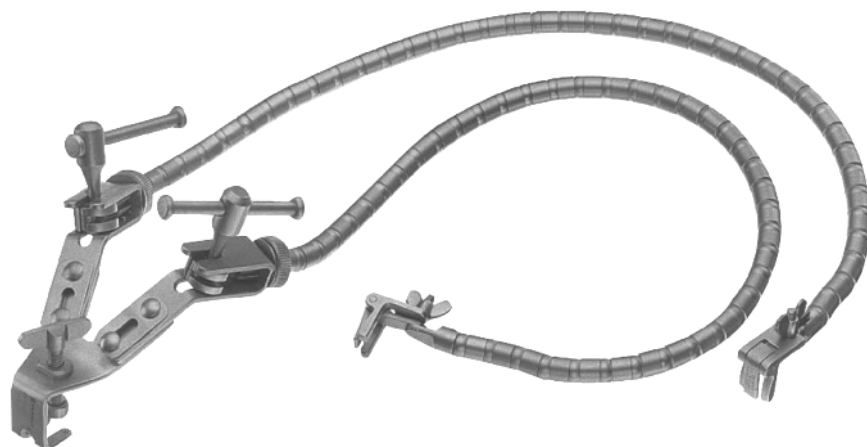

67-010-01
Yasargil (Leyla) Brain Retractor Single Arm
 Complete



67-010-02
Yasargil (Leyla) Brain Double Retractor Arm
 Complete



67-010-10
Yasargil (Leyla) Flexible Arm
 Complete



Self-Retaining Brain Retractor
Selbsthaltender Hirnretraktor
Separador cerebral autostático
Retracteur cérébrale autostatique
Retratore celebrale autostatico

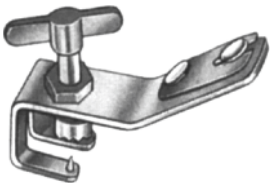

67-010-21
Yasargil (Leyla) Flexible Base



67-010-22
Yasargil (Leyla) Flexible Base

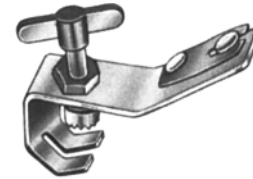

67-010-30
Yasargil (Leyla) Flexible Base



67-010-40
Yasargil (Leyla) Support For Round Spatulas



67-010-45
Yasargil (Leyla) Support For Flat Spatulas

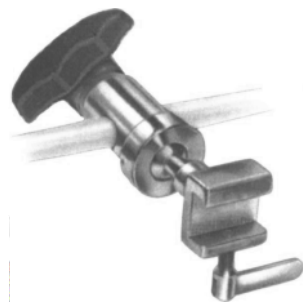

67-012-09
9 x 32 mm

67-012-10
10 x 25 mm

Yasargil (Leyla) Ball and Socket Joint



67-012-20
Yasargil (Leyla) Holding Rod

Self-Retaining Brain Retractor, Vertebral Distractor
 Selbsthaltender Hirnretraktor, Wirbel distractor
 Separador cerebral autostatico, Vertebrales distractor
 Retracteur cérébrale autostatique, Vertébrale distracteur
 Retratore celebrale autostatico, Vertebrale distrattore



67-012-25
 Yasargil (Leyla) Coupling Head



67-012-40
 Yasargil (Leyla) Coupling Head



67-020-01
 Caspar Vertebral Distractor
 Right



67-020-02
 Caspar Drill Guide
 Right



67-022-01
 Caspar Vertebral Distractor
 Left



67-022-02
 Caspar Drill Guide
 Left



Twist Drill
Gefäßclips, Approximatoren
Clips vasculares, Aproximadores
Clips vasculaires, Approximateurs
Clip vascolari, Approssimatori



67-024-00
Caspar Twist Drill
Overall Length 14.5 cm (5 ½")



67-026-14
14.0 mm
67-026-16
16.0 mm
67-026-18
18.0 mm
Caspar Distraction Screw



67-028-20
Caspar Screw Driver
Overall Length 20 cm (8")

Dissectomy Retractor
Muskelspreizer
Separadores para Músculos
Ecarteurs Musculaire
Divaricatori Muscolari



- 67-031-32**
32 x 25 mm
- 67-031-44**
44 x 25 mm
- 67-031-54**
54 x 25 mm
- 67-031-60**
60 x 25 mm

Meyerding Hemi-Laminectomy Retractor
Overall Length 20 cm (8")

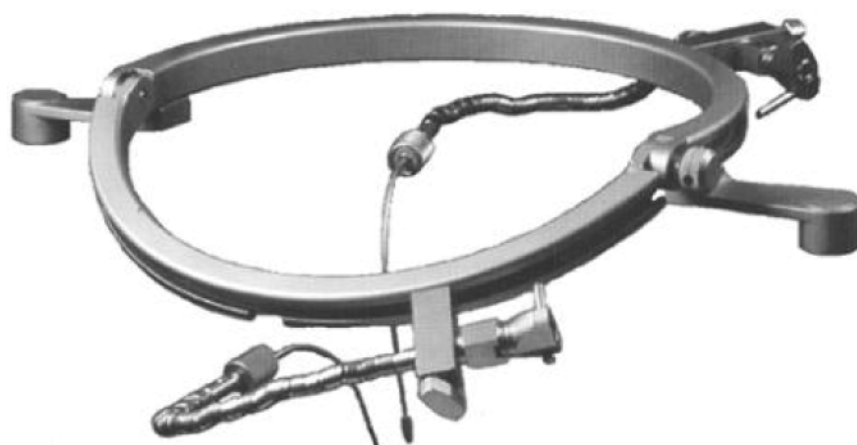

67-032-01
Brain Retractor
With Screw Fixation
90 x 60 mm

Dissectomy Retractor
 Muskelspreizer
 Separadores para Músculos
 Ecarteurs Musculaire
 Divaricatori Muscolari



- 67-033-40**
40 x 25 mm
- 67-033-50**
50 x 25 mm
- 67-033-60**
60 x 25 mm



- 67-035-40**
40 x 25 mm
- 67-035-50**
50 x 25 mm
- 67-035-60**
60 x 25 mm

Markham-Meyerdig Hemi-Laminectomy Retractor
 Right Solid Blade
 Overall Length 19 cm (7 ½")

Markham-Meyerdig Hemi-Laminectomy Retractor
 Left Solid Blade
 Overall Length 19 cm (7 ½")



Williams Dissectomy Retractor
 Overall Length 17 cm (6 ¾")

- 67-037-01**
10 x 50 mm
Left, Solid Blade
- 67-037-02**
10 x 60 mm
Left, Solid Blade
- 67-037-03**
10 x 70 mm
Left, Solid Blade
- 67-037-04**
20 x 50 mm
Left, Solid Blade
- 67-037-05**
20 x 60 mm
Left, Solid Blade
- 67-037-06**
20 x 70 mm
Left, Solid Blade

- 67-039-01**
10 x 50 mm
Right, Solid Blade
- 67-039-02**
10 x 60 mm
Right, Solid Blade
- 67-039-03**
10 x 70 mm
Right, Solid Blade
- 67-039-04**
20 x 50 mm
Right, Solid Blade
- 67-039-05**
20 x 60 mm
Right, Solid Blade
- 67-039-06**
20 x 70 mm
Right, Solid Blade

Skull Traction Tongs
Schädelhalter
Estribos de tracción craneal
Pinces de traction crânienne
Pinze per trazione craniale

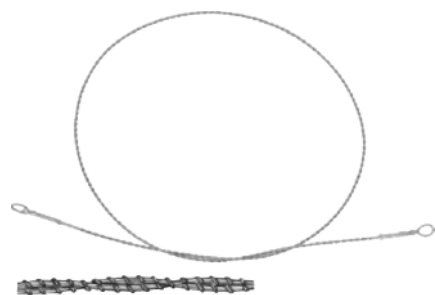

Gigli Wire Saw

67-050-30
30 cm (11 3/4")

67-050-40
40 cm (15 3/4")

67-050-60
50 cm (19 3/4")

67-050-60
60 cm (23 1/2")

67-050-70
70 cm (27 1/2")



67-055-00
Gigli Wire Saw Handle
Pair



67-058-00
De Martel Wire Saw Guide
Overall Length 33 cm (13")



67-061-01
Crutchfield Skull Traction Tongs
Small Pattern



67-061-02
Crutchfield Skull Traction Tongs
Medium Pattern

Skull Traction Tongs
Schädelhalter
Estribos de tracción craneal
Pinces de traction crânienne
Pinze per trazione craniale



67-065-35
3.5 mm

67-065-50
5.0 mm

Crutchfield Drill Point
Overall Length 7 cm (2 ¾")



67-071-00
Skull Traction Tongs
Large Pattern



67-075-01
Spare Pin



67-075-02
Wrench



Cranial Rongeurs
 Schädelzangen
 Pinzas sacabocados craneales
 Pincas emporte-pièces crâniennes
 Pinze per craniectomia



67-081-15
Adson Drill Guide & Dura Protector
 Overall Length 15 cm (6")



67-083-21
Bacon Cranial Rongeur
 Overall Length 21 cm (8 1/4")



Adson Cranial Rongeur
 Overall Length 20 cm (8")

67-086-20
 Straight

67-087-20
 Curved



67-091-20
Dahlgren Cranial Rongeur
 Overall Length 20 cm (8")



67-093-21
De Vilbiss Cranial Rongeur
 Overall Length 20.5 cm (8")

Clips and Applying Forceps
Clips und Anlegezangen
Grapas y pinzas aplicadoras
Clips et pinces pour appliquer
Agrafes e pinze per applicare



67-095-22
Cone Cranial Punch
Overall Length 22.5 cm (8 ¾")



67-097-21
Dura Strip Dissection Forcep
Angled
Overall Length 21.5 cm (8 ½")

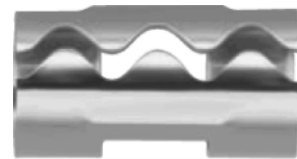

67-100-00
Raney Scalp Clip



67-102-00
Raney Applying-Removal Forcep
Overall Length 15.5 cm (6")

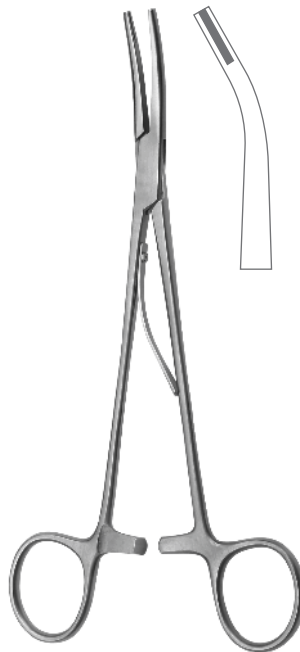

67-112-19
McKenzie Clip Applying Forcep
Overall Length 18.5 cm (7 ¼")

Clips and Applying Forceps
Clips und Anlegezangen
Grapas y pinzas aplicadoras
Clips et pinces pour appliquer
Agrafes e pinze per applicare



67-115-14
Olivecrona-Toennis Clip Applying Forcep
140 mm



67-118-00
Silver Brain Clip
Pack of 100



67-120-01
7.0 mm
31 cm (12 1/8")

67-120-02
9.0 mm
41 cm (16")

Yasargil Galea Hook
Spring

Dura Dissectors
 Duradisektoren
 Disecadores para duramadre
 Dissecteurs à dure-mère
 Dissettori per la dura-madre



67-151-21
Davis Dura Dissector
 Overall Length 21.5 cm (8 1/2")



67-153-24
Davis Dura Dissector
 Double Ended
 Overall Length
 24.5 cm (9 3/4")

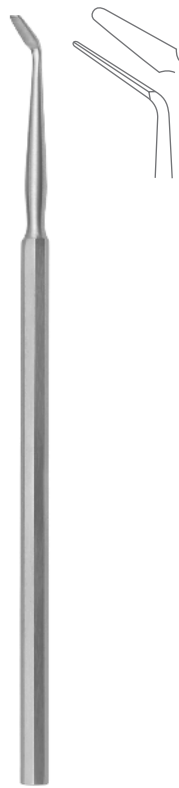

67-155-01
Frazier Dura Dissector
 Overall Length 15 cm (6")



67-155-02
 Fig. 2

67-155-03
 Fig. 3

Frazier Dura Dissector
 Overall Length 15 cm (6")



Dura Dissectors
 Duradissektoren
 Disecadores para duramadre
 Dissecteurs à dure-mère
 Dissettori per la dura-madre



67-157-16
Love-Adson Dura Dissector
 Overall Length 16 cm (6 1/2")

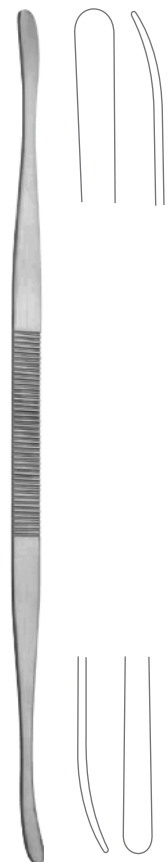

67-159-26
Toennis Dura Dissector
 Overall Length 26 cm (10 1/4")



67-161-01
Olivecrona Dura Dissector
 Overall Length 24 cm (9 1/2")



67-161-02
Olivecrona Dura Dissector
 Overall Length 18 cm (7")

Dura Dissectors
 Duradisektoren
 Disecadores para duramadre
 Dissecteurs à dure-mère
 Dissettori per la dura-madre

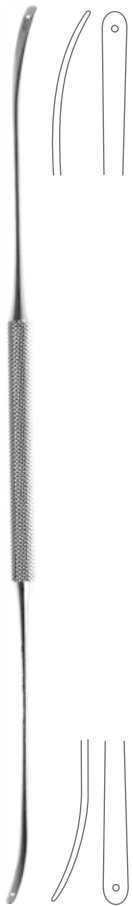

67-161-03
Olivecrona Dura Dissector
 Overall Length 24 cm (9 ½")



67-161-04
Olivecrona Dura Dissector
 Overall Length 20 cm (8")



67-163-21
Sachs Dura Dissector
 Overall Length 20 cm (8")



67-165-21
Milligan Dura Dissector
 Overall Length 21.5 cm (8 ½")

Dura Dissectors
 Duradissektoren
 Disecadores para duramadre
 Dissecteurs à dure-mère
 Dissettori per la dura-madre

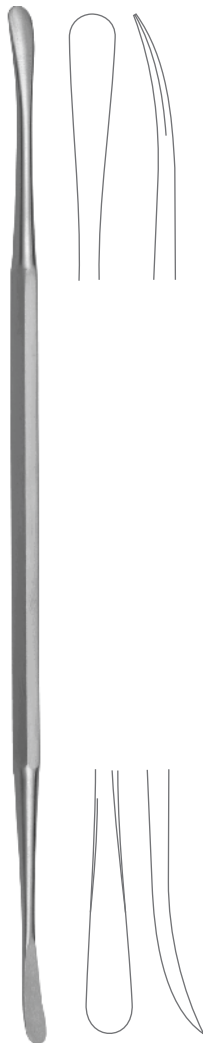

67-167-22
Dura Dissector
 Overall Length 22 cm (8 3/4")



67-171-01
Penfield Dura Dissector
 Fig. 1
 Overall Length 17.5 cm (7")



67-171-02
Penfield Dura Dissector
 Fig. 2
 Overall Length 19.5 cm (7 3/4")



67-171-03
Penfield Dura Dissector
 Fig. 3
 Overall Length 19.5 cm (7 3/4")

Dura Dissectors, Nerve Root Elevator
 Duradissektoren, Nervwurzelhaken
 Disecadores para duramadre, Separadores para la raíz de nervio
 Dissecteurs à dure-mère, Retracteurs pour racines nerveuses
 Dissettori per la dura-madre, Uncini per le radici die nervi



67-171-04
Penfield Dura Dissector
 Fig. 4
 Overall Length 20 cm (8")



67-171-05
Penfield Dura Dissector
 Fig. 5
 Overall Length 18 cm (7")



67-181-20
Horsley Dura Elevator
 Overall Length 20 cm (8")



67-183-21
Sachs Dura Elevator
 Overall Length 21 cm (8 ¼")

Nerve Root Retractors
 Nervwurzelhaken
 Separadores para la raíz de nervio
 Retracteurs pour racines nerveuses
 Uncini per le radici die nervi



67-190-21
Love Nerve Root Retractor
 Straight
 Overall Length 21.5 cm (8 1/2")



67-191-18
Love Nerve Root Retractor
 Angled 45°
 Overall Length 17.5 cm (7")



67-193-18
Love Nerve Root Retractor
 Angled 90°
 Overall Length 11 cm (4 1/4")

Nerve Root Retractors
Nervwurzelhaken
Separadores para la raíz de nervio
Retracteurs pour racines nerveuses
Uncini per le radici die nervi



67-195-21
Lover Nerve Root Retractor
Overall Length 22 cm (8 3/4")



Caspar Nerve Root Retractor
Overall Length 24 cm (9 1/2")

67-196-04
4.0 mm

67-196-06
6.0 mm

67-196-08
8.0 mm

67-196-10
10.0 mm



67-197-03
3.0 mm

67-197-05
5.0 mm

67-197-07
7.0 mm

Hess Nerve Root Retractor
Overall Length 17.5 cm (7")

Nerve Root Retractors
 Nervwurzelhaken
 Separadores para la raíz de nervio
 Retracteurs pour racines nerveuses
 Uncini per le radici die nervi



67-200-23
Scoville Nerve Root Retractor
 Overall Length 23.5 cm (9 1/4")



67-201-24
Holsher Nerve Root Retractor
 Overall Length 23.5 cm (9 1/4")



67-203-19
Scoville Nerve Root Retractor
 Overall Length 16.5 cm (6 1/2")

Brain Spatulas
Hirnspatel
Espátulas cerebrales
Spatules cérébrales
Spatole cerebrali

67

NEUROSURGERY



67-205-21
Campbell Nerve Root Retractor
Malleable
Overall Length 21.5 cm (8 ½")



Cushing Brain Spatulas
Overall Length 18 cm (7")

- 67-210-07**
7 + 9 mm
- 67-210-11**
11 + 13 mm
- 67-210-15**
15 + 18 mm
- 67-210-18**
18 + 22 mm

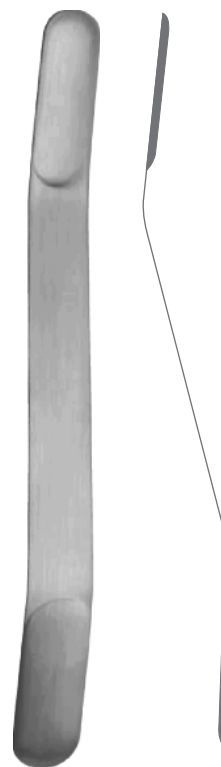

Olivecrona Brain Spatulas
Concave
Overall Length 18 cm (7")

- 67-213-07**
7 + 9 mm
- 67-213-11**
11 + 13 mm
- 67-213-15**
15 + 18 mm
- 67-213-18**
18 + 22 mm

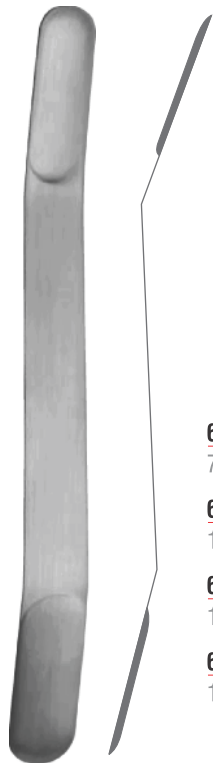
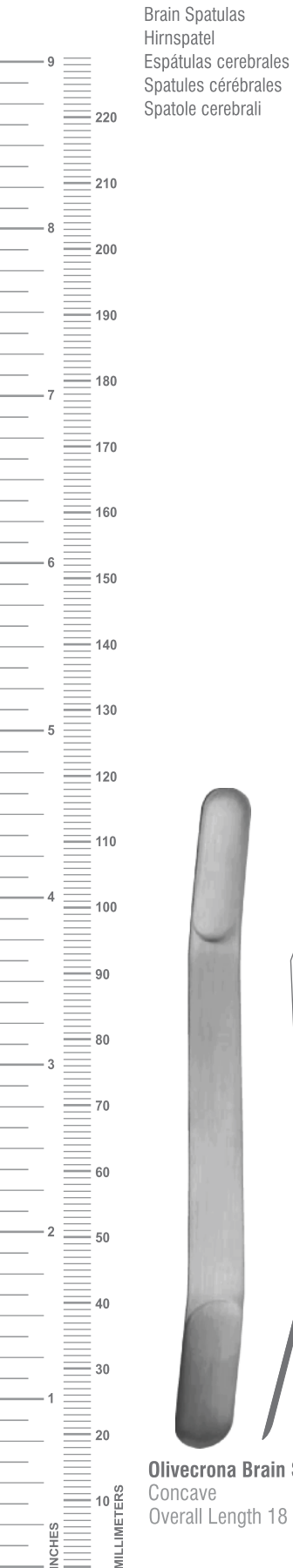

67-215-07

7 + 9 mm

67-215-11

11 + 13 mm

67-215-15

15 + 18 mm

67-215-18

18 + 22 mm

Olivecrona Brain Spatulas

Concave
Overall Length 18 cm (7")



67-218-07

7 + 8 mm

67-218-10

10 + 11 mm

67-218-13

13 + 14 mm

67-218-15

15 + 17 mm

67-218-19

19 + 20 mm

67-218-22

22 + 22 mm

Heifetz Brain Spatulas

Overall Length 20 cm (8")



67-221-08

8.0 mm

67-221-11

11.0 mm

67-221-14

14.0 mm

67-218-17

17.0 mm

67-221-20

20.0 mm

Heifetz Brain Spatulas

Round Handle
Overall Length 20 cm (8")



67-224-12

12.0 mm

67-224-17

17.0 mm

Brain Spatulas

Overall Length 20 cm (8")

Nerve Hooks
Nervhaken
Ganchos para nervios
Crochets à nerfs
Uncini per nervi



67-231-17
17 cm (6 3/4")

67-233-21
21 cm (8 1/4")

Smithwick Nerve Hook



67-234-20
Sharp

67-235-20
Blunt

Adson Dura Hook
Overall Length 20 cm (8")



67-237-16
Graham Dura Hook
Blunt
Overall Length 16.5 cm (6 1/2")



67-239-18
Sachs Dura Hook
Sharp
Overall Length 18 cm (7")

Nerve Hooks
Nervhaken
Ganchos para nervios
Crochets à nerfs
Uncini per nervi



67-241-18
Frazier Dura Hook
Sharp
Overall Length 13 cm (5")



67-245-22
Hoen Dura Hook
Overall Length 22 cm (8 3/4")

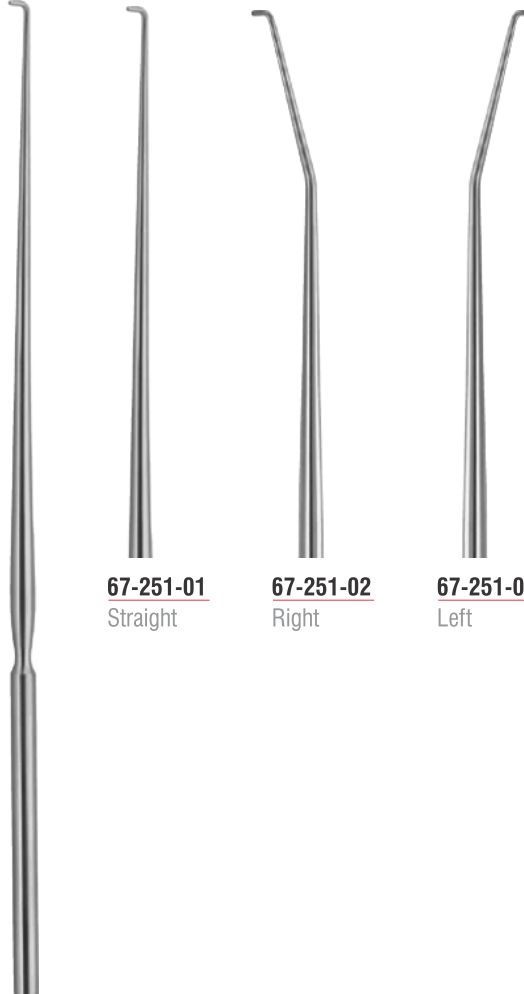

67-251-01
Straight

67-251-02
Right

67-251-03
Left

Dandy Nerve Retractor
Overall Length 20 cm (8")

Dura Knives
Duramesser
Bisturís para duramadre
Bistouries pour duremère
Bisturi per duramadre



67-253-29
Smithwick Nerve Retractor
Overall Length 29 cm (11 ½")



67-261-15
Toennis Nerve Retractor
Overall Length 15 cm (6")



67-280-18
Toennis Brain Knife
Overall Length 18 cm (7")



67-282-20
Halle Brain Knife
Overall Length 20 cm (8")

Laminectomy Punches
 Laminektomiestanzen
 Pinzas cortantes para laminectomia
 Pinces emporte-pièces à laminectomie
 Pinze taglianti per laminectomia

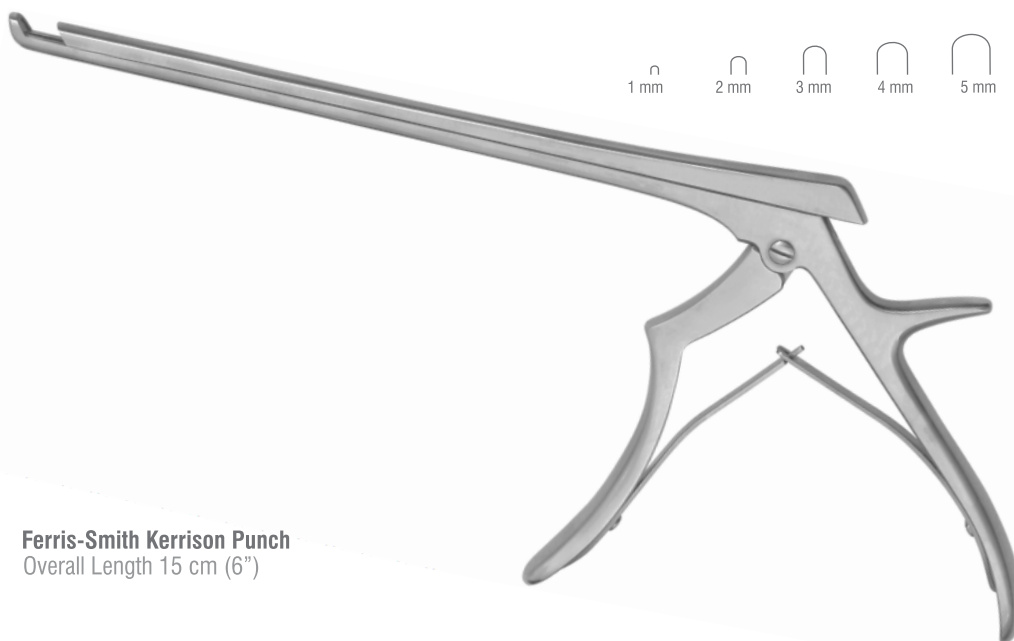

Ferris-Smith Kerrison Punch
 Overall Length 15 cm (6")



Up Cutting

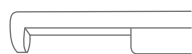

Down Cutting



40° Forward
Up Cutting



40° Forward
Down Cutting

67-300-01

1.0 mm

67-300-02

2.0 mm

67-300-03

3.0 mm

67-300-04

4.0 mm

67-300-05

5.0 mm

67-301-01

1.0 mm

67-301-02

2.0 mm

67-301-03

3.0 mm

67-301-04

4.0 mm

67-301-05

5.0 mm

67-302-01

1.0 mm

67-302-02

2.0 mm

67-302-03

3.0 mm

67-302-04

4.0 mm

67-302-05

5.0 mm

67-303-01

1.0 mm

67-303-02

2.0 mm

67-303-03

3.0 mm

67-303-04

4.0 mm

67-303-05

5.0 mm

Laminectomy Punches
 Laminektomiestanzen
 Pinzas cortantes para laminectomía
 Pincas emporte-pièces à laminectomie
 Pinze taglienti per laminectomia

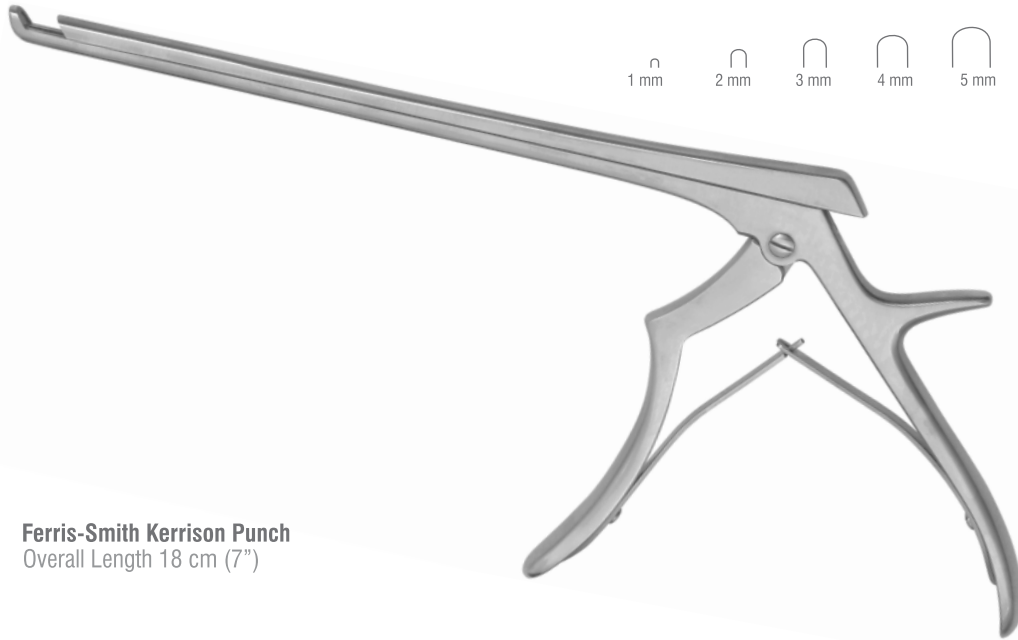

Ferris-Smith Kerrison Punch
 Overall Length 18 cm (7")

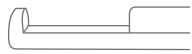

Up Cutting

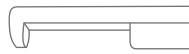

Down Cutting



40° Forward
Up Cutting



40° Forward
Down Cutting

67-304-01

1.0 mm

67-304-02

2.0 mm

67-304-03

3.0 mm

67-304-04

4.0 mm

67-304-05

5.0 mm

67-305-01

1.0 mm

67-305-02

2.0 mm

67-305-03

3.0 mm

67-305-04

4.0 mm

67-305-05

5.0 mm

67-306-01

1.0 mm

67-306-02

2.0 mm

67-306-03

3.0 mm

67-306-04

4.0 mm

67-306-05

5.0 mm

67-307-01

1.0 mm

67-307-02

2.0 mm

67-307-03

3.0 mm

67-307-04

4.0 mm

67-307-05

5.0 mm

Laminectomy Punches
 Laminektomiestanzen
 Pinzas cortantes para laminectomia
 Pinces emporte-pièces à laminectomie
 Pinze taglianti per laminectomia

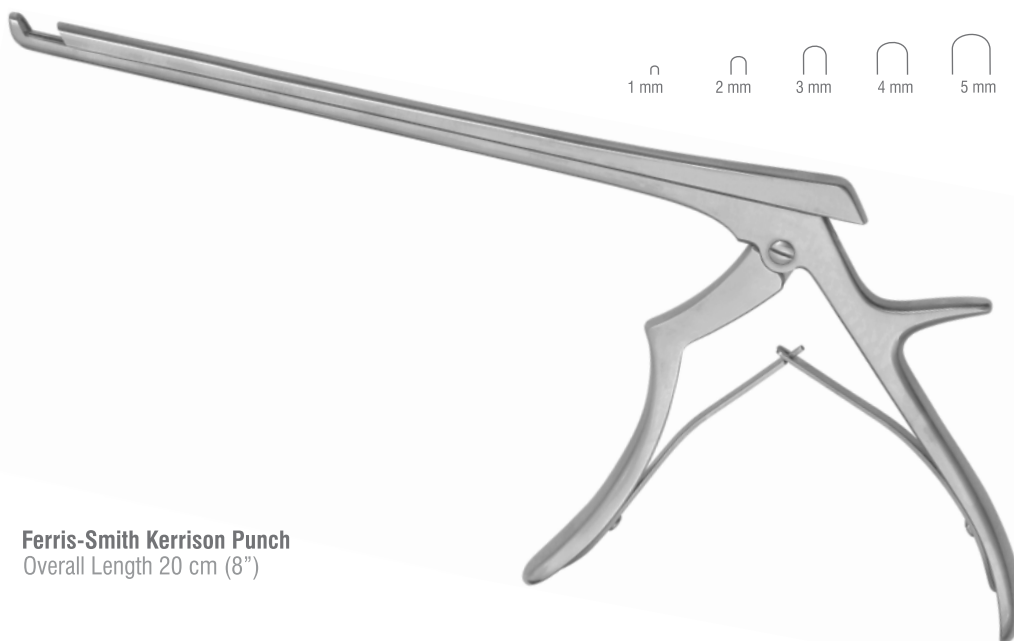

Ferris-Smith Kerrison Punch
 Overall Length 20 cm (8")



Up Cutting

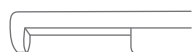

Down Cutting



40° Forward
Up Cutting



40° Forward
Down Cutting

67-308-01
 1.0 mm

67-308-02
 2.0 mm

67-308-03
 3.0 mm

67-308-04
 4.0 mm

67-308-05
 5.0 mm

67-309-01
 1.0 mm

67-309-02
 2.0 mm

67-309-03
 3.0 mm

67-309-04
 4.0 mm

67-309-05
 5.0 mm

67-310-01
 1.0 mm

67-310-02
 2.0 mm

67-310-03
 3.0 mm

67-310-04
 4.0 mm

67-310-05
 5.0 mm

67-311-01
 1.0 mm

67-311-02
 2.0 mm

67-311-03
 3.0 mm

67-311-04
 4.0 mm

67-311-05
 5.0 mm

INCHES
 MILLIMETERS

Laminectomy Punches
 Laminektomiestanzen
 Pinzas cortantes para laminectomía
 Pincas emporte-pièces à laminectomie
 Pinze taglianti per laminectomia



Ferris-Smith Kerrison Punch
 Detachable Model
 Overall Length 18 cm (7")



67-320-01
 1.0 mm

67-320-02
 2.0 mm

67-320-03
 3.0 mm

67-320-04
 4.0 mm

67-320-05
 5.0 mm



67-321-01
 1.0 mm

67-321-02
 2.0 mm

67-321-03
 3.0 mm

67-321-04
 4.0 mm

67-321-05
 5.0 mm



67-322-01
 1.0 mm

67-322-02
 2.0 mm

67-322-03
 3.0 mm

67-322-04
 4.0 mm

67-322-05
 5.0 mm



67-323-01
 1.0 mm

67-323-02
 2.0 mm

67-323-03
 3.0 mm

67-323-04
 4.0 mm

67-323-05
 5.0 mm

Laminectomy Punches
 Laminektomiestanzen
 Pinzas cortantes para laminectomia
 Pincas emporte-pièces à laminectomie
 Pinze taglianti per laminectomia



Ferris-Smith Kerrison Punch
 Detachable Model
 Overall Length 20 cm (8")



Up Cutting



Down Cutting



40° Forward
Up Cutting



40° Forward
Down Cutting

67-324-01
 1.0 mm

67-324-02
 2.0 mm

67-324-03
 3.0 mm

67-324-04
 4.0 mm

67-324-05
 5.0 mm

67-325-01
 1.0 mm

67-325-02
 2.0 mm

67-325-03
 3.0 mm

67-325-04
 4.0 mm

67-325-05
 5.0 mm

67-326-01
 1.0 mm

67-326-02
 2.0 mm

67-326-03
 3.0 mm

67-326-04
 4.0 mm

67-326-05
 5.0 mm

67-327-01
 1.0 mm

67-327-02
 2.0 mm

67-327-03
 3.0 mm

67-327-04
 4.0 mm

67-327-05
 5.0 mm

Laminectomy Punches
 Laminektomiestanzen
 Pinzas cortantes para laminectomía
 Pincas emporte-pièces à laminectomie
 Pinze taglienti per laminectomia



Cushing Laminectomy Rongeur

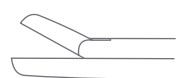

67-400-01
 Straight
 2 x 10 mm

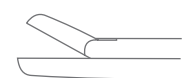

67-401-01
 Straight
 2 x 10 mm



67-402-01
 Straight
 2 x 10 mm

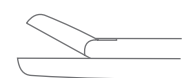

67-403-01
 Straight
 2 x 10 mm

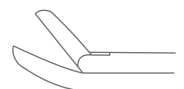

67-400-02
 Up
 2 x 10 mm



67-401-02
 Up
 2 x 10 mm



67-402-02
 Up
 2 x 10 mm



67-403-02
 Up
 2 x 10 mm



67-400-03
 Down
 2 x 10 mm



67-401-03
 Down
 2 x 10 mm



67-402-03
 Down
 2 x 10 mm



67-403-03
 Down
 2 x 10 mm

Overall Length 13 cm (5")

Overall Length 15 cm (6")

Overall Length 18 cm (6")

Overall Length 20 cm (8")

Laminectomy Punches
 Laminektomiestanzen
 Pinzas cortantes para laminectomia
 Pincas emporte-pièces à laminectomie
 Pinze taglianti per laminectomia



Love-Gruenwald Laminectomy Rongeur

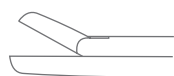

67-404-01
 Straight
 3 x 10 mm

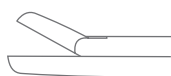

67-405-01
 Straight
 3 x 10 mm

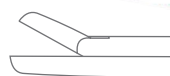

67-406-01
 Straight
 3 x 10 mm

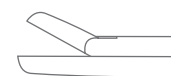

67-407-01
 Straight
 3 x 10 mm



67-404-02
 Up
 3 x 10 mm



67-405-02
 Up
 3 x 10 mm

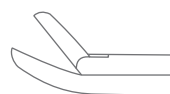

67-406-02
 Up
 3 x 10 mm



67-407-02
 Up
 3 x 10 mm

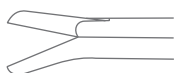

67-404-03
 Down
 3 x 10 mm

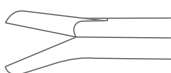

67-405-03
 Down
 3 x 10 mm

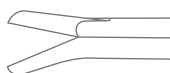

67-406-03
 Down
 3 x 10 mm

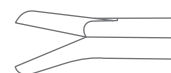

67-407-03
 Down
 3 x 10 mm

Overall Length 13 cm (5")

Overall Length 15 cm (6")

Overall Length 18 cm (6")

Overall Length 20 cm (8")

Laminectomy Punches
 Laminektomiestanzen
 Pinzas cortantes para laminectomía
 Pincas emporte-pièces à laminectomie
 Pinze taglianti per laminectomia

NEUROSURGERY

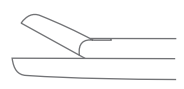
Spurling Laminectomy Rongeur

67-408-01
 Straight
 4 x 10 mm

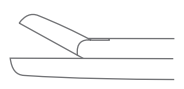

67-409-01
 Straight
 4 x 10 mm

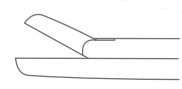

67-410-01
 Straight
 4 x 10 mm

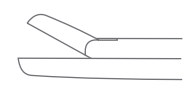

67-411-01
 Straight
 4 x 10 mm

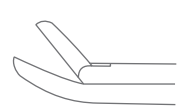

67-408-02
 Up
 4 x 10 mm

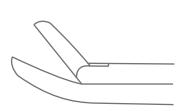

67-409-02
 Up
 4 x 10 mm

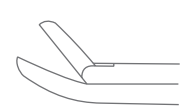

67-410-02
 Up
 4 x 10 mm

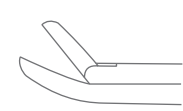

67-411-02
 Up
 4 x 10 mm

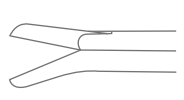

67-408-03
 Down
 4 x 10 mm

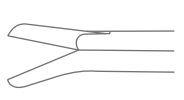

67-409-03
 Down
 4 x 10 mm

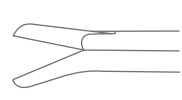

67-410-03
 Down
 4 x 10 mm

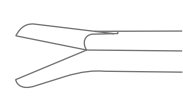

67-411-03
 Down
 4 x 10 mm

Overall Length 13 cm (5")

Overall Length 15 cm (6")

Overall Length 18 cm (6")

Overall Length 20 cm (8")

Laminectomy Punches
Laminektomiestanzen
Pinzas cortantes para laminectomia
Pinces emporte-pièces à laminectomie
Pinze taglianti per laminectomia



Laminectomy Rongeur
Fenestrated and Serrated Jaws
Overall Length 18 cm (7")



67-440-01
Straight
2 x 12 mm



67-441-01
Straight
3 x 12 mm



67-442-01
Straight
4 x 14 mm



67-443-01
Straight
5 x 12 mm



67-444-01
Straight
6 x 12 mm



67-440-02
Up
2 x 12 mm



67-441-02
Up
3 x 12 mm



67-442-02
Up
4 x 14 mm



67-443-02
Up
5 x 12 mm



67-444-02
Up
6 x 12 mm



67-440-03
Down
2 x 12 mm



67-441-03
Down
3 x 12 mm



67-442-03
Down
4 x 14 mm



67-443-03
Down
5 x 12 mm



67-444-03
Down
6 x 12 mm

INCHES
MILLIMETERS

Laminectomy Punches
Laminektomiestanzen
Pinzas cortantes para laminectomía
Pincas emporte-pièces à laminectomie
Pinze taglianti per laminectomia

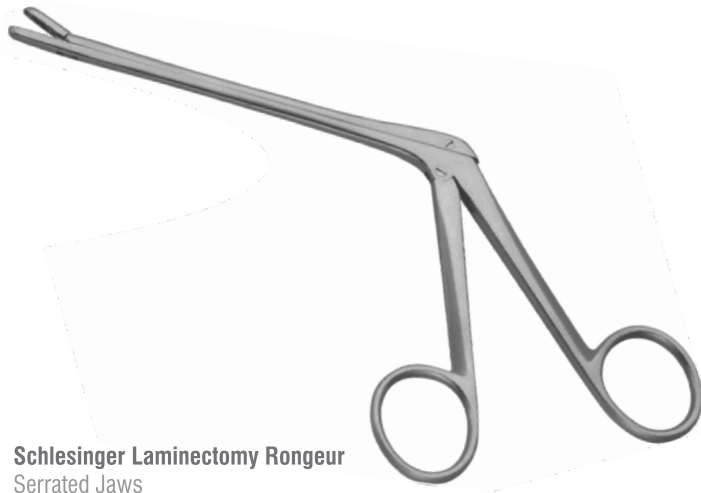

Schlesinger Laminectomy Rongeur
Serrated Jaws
Overall Length 13 cm (5")

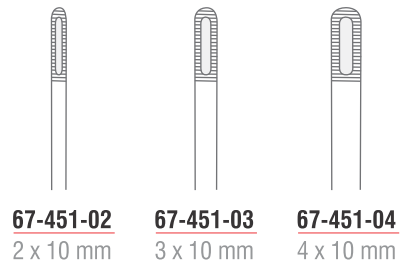

67-451-02
2 x 10 mm

67-451-03
3 x 10 mm

67-451-04
4 x 10 mm



67-461-35
Yasargil Tumor Grasping Forcep
Ø 3.5 mm
Overall Length 20 cm (8")



67-463-60
Oldberg Tumor Grasping Forcep
Ø 6.5 mm
Overall Length 18 cm (8")

Laminectomy Punches
Laminektomiestanzen
Pinzas cortantes para laminectomia
Pincas emporte-pièces à laminectomie
Pinze taglianti per laminectomia

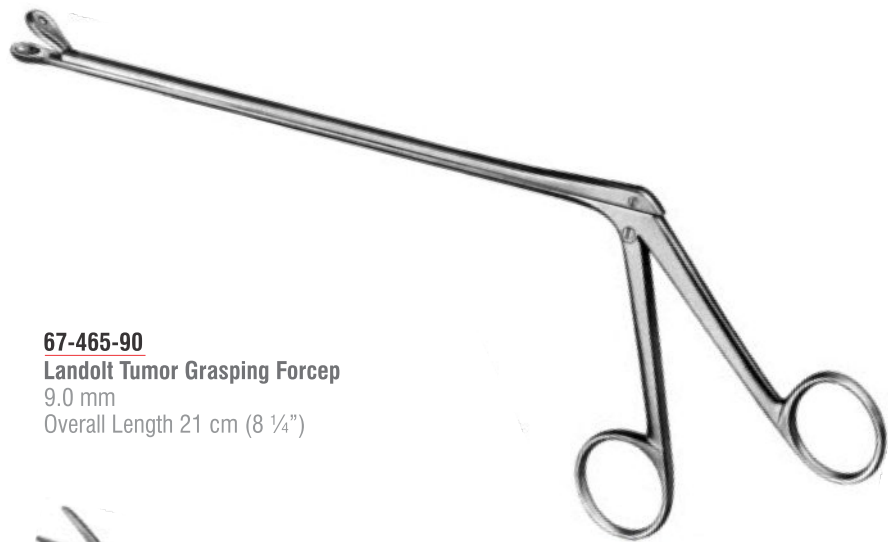

67-465-90
Landolt Tumor Grasping Forcep
9.0 mm
Overall Length 21 cm (8 1/4")



Caspar Laminectomy Rongeur
Straight
Overall Length 17 cm (6 3/4")

67-480-03
3.0 mm

67-480-04
4.0 mm

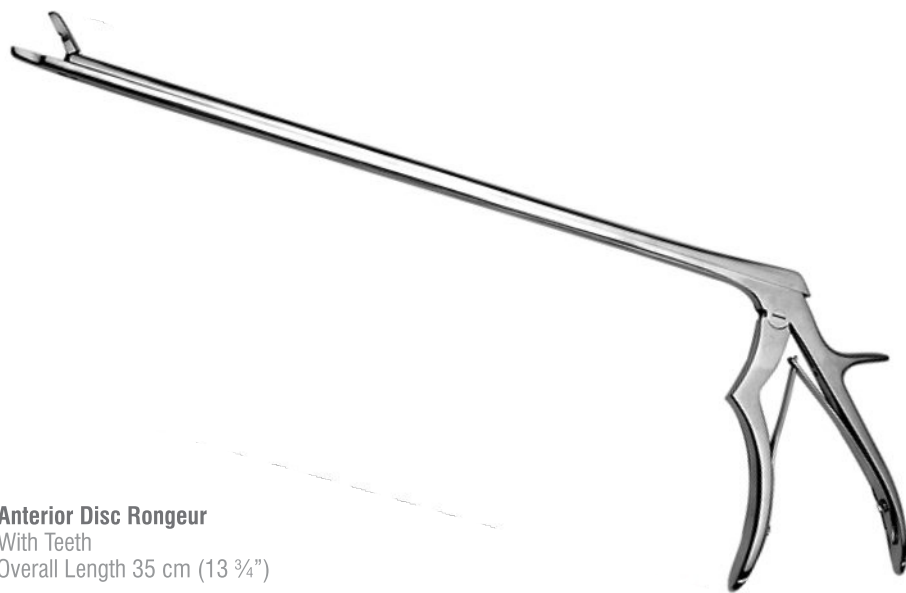

Anterior Disc Rongeur
With Teeth
Overall Length 35 cm (13 3/4")

67-481-01
Straight

67-481-02
Curved Upwards

Laminectomy Punches
Laminektomiestanzen
Pinzas cortantes para laminectomia
Pinces emporte-pièces à laminectomie
Pinze taglienti per laminectomia



67-482-04
Caspar Laminectomy Rongeur
Straight, 4.0 mm
Overall Length 20.5 cm (8")

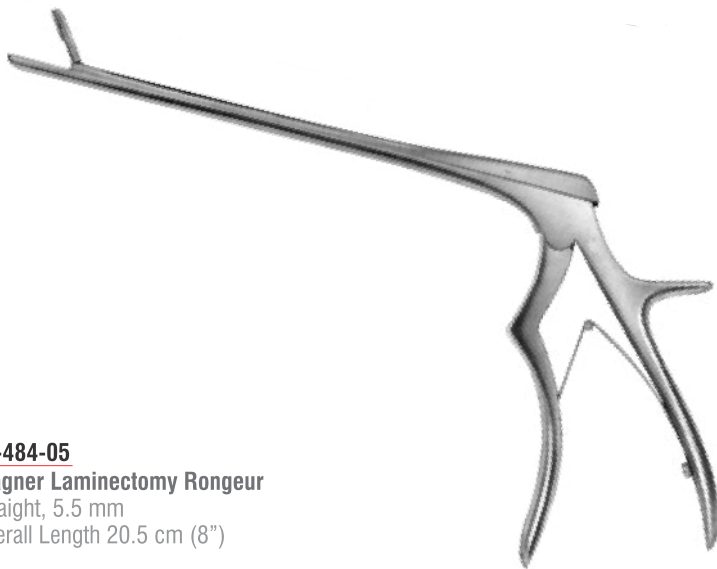

67-484-05
Wagner Laminectomy Rongeur
Straight, 5.5 mm
Overall Length 20.5 cm (8")



67-492-02
Sybert Laminectomy Rongeur
Curved, Upwards, 5.8 mm
Overall Length 25 cm (10")



Micro Neuro Instruments
Mikro Neuro Instrumente
Micro Neuro Instrumentos
Micro Neuro Instruments
Micro Neuro Strumenti



67-550-18
Jacobson Micro Knife
Straight
Overall Length 18.5 cm (7 1/4")

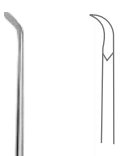

67-555-01

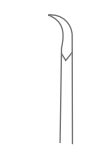

67-555-02



67-555-03

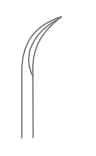

67-555-04

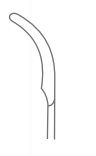

67-557-01



67-557-02

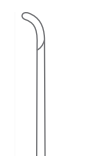

67-559-01

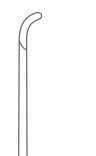

67-559-02

Koos Micro Knife
Bayonet Shaped
Overall Length 18.5 cm (7 1/4")

Yasargil Micro Knife
Bayonet Shaped
Overall Length 18.5 cm (7 1/4")

Micro Neuro Instruments
Mikro Neuro Instrumente
Micro Neuro Instrumentos
Micro Neuro Instruments
Micro Neuro Strumenti

67

NEUROSURGERY

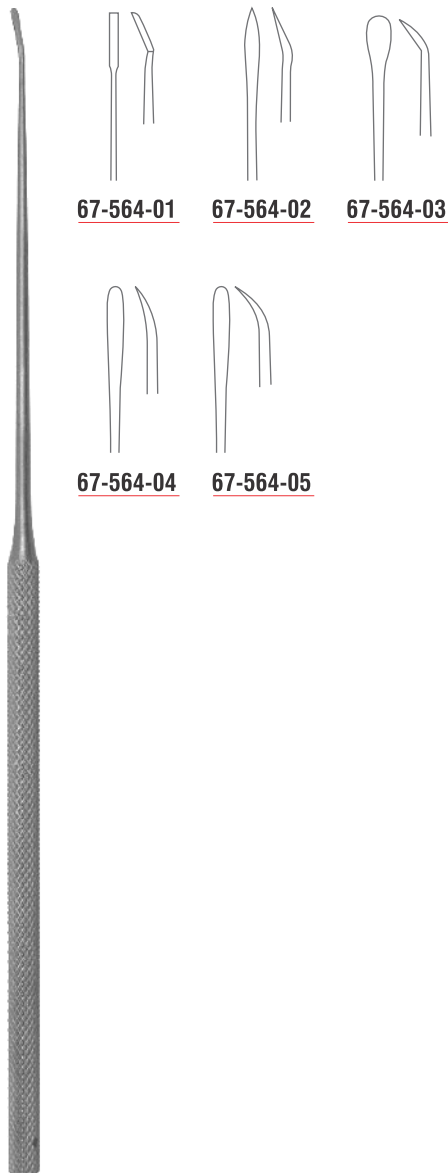

Yasargil Micro Respiratory
Overall Length 18.5 cm (7 1/4")



Yasargil Micro Respiratory
Bayonet Shaped
Overall Length 18.5 cm (7 1/4")



67-567-18
Yasargil Micro Curette
Bayonet Shaped
Overall Length 18.5 cm (7 1/4")



Micro Neuro Instruments
 Mikro Neuro Instrumente
 Micro Neuro Instrumentos
 Micro Neuro Instruments
 Micro Neuro Strumenti



67-571-01
3.0 mm
67-571-02
5.0 mm

Micro Nerve & Vessel Curette
Overall Length 18.5 cm (7 1/4")



67-573-01
Fig. 1

67-573-02
Fig. 2

67-573-03
Fig. 3

67-573-04
Fig. 4

Krayenbuhl Micro Nerve & Vessel Hook
Overall Length 18.5 cm (7 1/4")

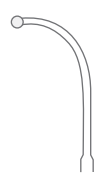

67-575-01
Fig. 1

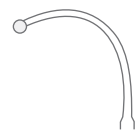

67-575-02
Fig. 2

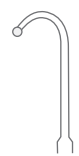

67-575-03
Fig. 3



67-575-04
Fig. 4

Yasargil Ligature Guide
Overall Length 18.5 cm (7 1/4")

Micro Neuro Instruments
Mikro Neuro Instrumente
Micro Neuro Instrumentos
Micro Neuro Instruments
Micro Neuro Strumenti



67-577-01

Fig. 1
Ø 0.5 mm

67-577-02

Fig. 2
Ø 1.0 mm

67-577-03

Fig. 3
Ø 1.5 mm

67-576-16
Biemer Vessel Spreader
Overall Length 16 cm (6 1/4")

Micro Vessel Dilator
Overall Length 12.5 cm (5")



67-579-01
1 Prong

67-579-02
2 Prongs

Jacobson Micro Vessel Probe
Overall Length 18.5 cm (7 1/4")



67-579-03
Jacobson Micro Suture Probe
Overall Length 18.5 cm (7 1/4")

Micro Neuro Instruments
 Mikro Neuro Instrumente
 Micro Neuro Instrumentos
 Micro Neuro Instruments
 Micro Neuro Strumenti



Caspas Exploration Hook
 Overall Length 24.5 cm, (9 1/2")

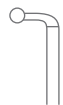

67-581-01
 Fig. 1



67-581-02
 Fig. 2



67-581-03
 Fig. 3



67-581-04
 Fig. 4



67-590-00
Rhoton Micro Dissector
 Set of 15
 Ref: 67-591-01 up to
 67-591-15



Rhoton Micro Dissector
 Overall Length 18.5 cm (7 1/4")



67-591-01
 Ø 1.0 mm



67-591-02
 Ø 2.0 mm

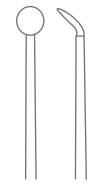

67-591-03
 Ø 3.0 mm

Round Shaped

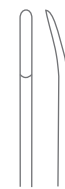

67-591-04
 Ø 1.0 mm

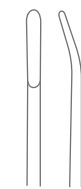

67-591-05
 Ø 1.5 mm

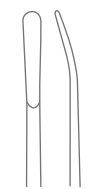

67-591-06
 Ø 2.0 mm

Spatula Shaped

Micro Neuro Instruments
Mikro Neuro Instrumente
Micro Neuro Instrumentos
Micro Neuro Instruments
Micro Neuro Strumenti

67

NEUROSURGERY

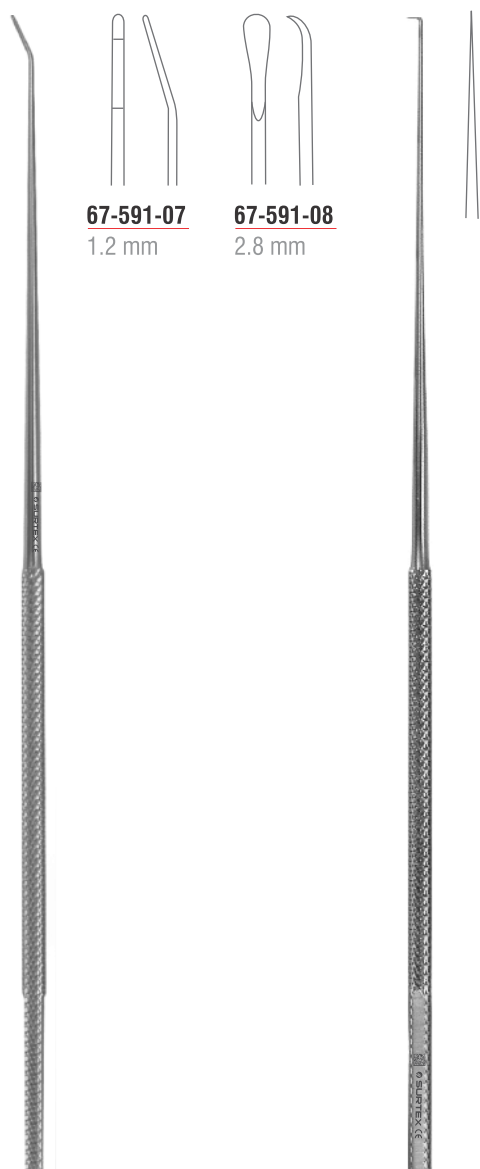

67-591-07
1.2 mm

67-591-08
2.8 mm

Rhoton Micro Elevator
Overall Length 18.5 cm (7 1/4")

67-591-09
Rhoton Micro Needle
Semi, Sharp
Overall Length 18.5 cm (7 1/4")

67-591-15
Rhoton Micro Curette
Angled 45°, 1.0 x 2.0 mm
Overall Length 18.5 cm (7 1/4")



SUNMARK
INSTRUMENTS

Mark Of Quality

Neurosurgery Instruments Catalogue

+92 (331) 661 9646

www.sunmarkinstruments.com

info@sunmarkinstruments.com

1528 Walnut Street Suite 200 Philadelphia, PA 19102 USA

