



SUNMARK
INSTRUMENTS

Mark Of Quality



ORAL
MAXILLOFACIAL
& ENT INSTRUMENTS
CATALOGUE



www.sunmarkinstruments.com



INTRODUCTION

► INTRODUCTION TO THE CATALOGUE

Thank you for your interest in SunMark Oral, Maxillofacial and ENT Instruments. We remain committed to providing the highest quality products and customer service.

In this special catalogue you will find a comprehensive range of Oral, Maxillofacial and ENT Instruments, which have been developed following detailed consultation with leading Oral, Maxillofacial and ENT surgeons. These instruments in conjunction with SunMark General Instruments provides complete solution for oral, maxillofacial, otology, rhinology, rhinoplasty, tonsillectomy and tracheotomy surgeries.

We appreciate your patronage and look forward to a successful relationship with you.

► ABOUT SUNMARK INSTRUMENTS

Sunmark Instruments is a privately owned medical technology company dedicated to innovation and excellence in crafting of surgical instruments. The company started as a specialist in reconstructive surgery instruments and based on its success and innovative drive gradually expanded to cover a vast range of surgical instruments.

We now manufacture over 8,000 surgical instruments and offer innovative solutions in trauma, gynecology, cardiovascular, microsurgery and dental surgery. All our products are available to view online where you can download our entire range of catalogues or request a printed version.

WHY IS SUNMARK FOCUSED ON INSTRUMENTS QUALITY?

Surgeons are highly talented and skilled individuals. They operate under significant time constraints and are required to make split second decisions while performing complex operations. At ASunMark we understand that in such a scenario the surgeon requires tools that are not just fit for the purpose but are reliable, dependable and crafted by a company that has a track record for relentless pursuit for excellence in the making of surgical instruments.

► AFFORDABLE QUALITY

Surgical instruments represent a significant proportion of hospital's total assets. Hospitals and health centers are often required to minimize costs of surgical instruments without impacting quality or patient's health. Decision makers tend to respond via group purchasing contracts & multiple quotes to shop around for the lowest price. However this approach has significant drawbacks as numerous instrument companies have focused towards competing on price alone with a disregard towards instruments quality while claiming their instruments to be guaranteed and free of defect.

The outcome for the buyer being a perceived notion of a quality instrument, which is actually little more than a knock-off and delivers only poor value for money.

At **Sunmark Instruments** our success has been based on helping customers navigate successfully through the instrument procurement process by identifying real value for money through fair comparison. We believe that quality should be affordable and you should not pay too much for over priced brands and neither should you pay too much for a low quality instrument.

► SUNMARK QUALITY STANDARDS

In European Union medical devices are subject to a series of uniform laws and the EC directive places rigid demands on surgical instruments. Sunmark Instruments is proud to claim that we have always surpassed the legal requirements to ensure that each instrument reaching the surgeons hand is indeed a testament to surgical craftsmanship.

► LIFE TIME WARRANTY

We encourage our customers to calculate lifetime costs prior to making purchase decisions and investing in surgical instruments.

Sunmark Instruments are guaranteed for life* against manufacturing defects of material and workmanship. This means we will repair or replace free of charge any surgical instrument that does not meet its functional requirements when used for its intended purpose and maintained properly.





Inspection and Functional Testing

- Visually inspect and check: - all instruments for damage and wear; cutting edges are free from nicks and present a continuous edge; jaws and teeth align correctly; all articulated instruments have a smooth movement without excess play; locking mechanisms (such as ratchets) fasten securely and close easily; long, slender instruments are not distorted; any component parts fit and assemble correctly with mating components.
- Remove for repair and replacement any blunt, worn out, flaking, fractured or damaged instruments.

Note: If an instrument is returned to the manufacturer / supplier, the instrument must be decontaminated and sterilized and be accompanied with the relevant documented evidence.

Packaging

- All instruments to be packed following local protocol in accordance with ISO 11607-1 or AAMI/CSR technique.

Sterilization (USA)

- Autoclave should comply with the requirements of, and be validated and maintained in accordance with ANSI/AAMI ST79.
- Pre-Vacuum moist heat sterilization operating at temperature 132 °C bar for a minimum holding time of 4 minutes always following the instructions of the machine manufacturer.
- When sterilizing multiple instruments in one autoclave cycle, ensure that the sterilizer manufacturers stated maximum load is not exceeded.
- Ensure instruments are dry before sterilization.

Sterilization (Outside USA)

- Autoclave should comply with the requirements of, and be validated and maintained in accordance with EN 285, EN 13060, EN ISO 17665.
- Either CE marked or validated vacuum autoclave operating at 134-137 °C bar for a minimum holding time of 3 minutes always following the instructions of the machine manufacturer.
- When sterilizing multiple instruments in one autoclave cycle, ensure that the sterilizer manufacturers stated maximum load is not exceeded.

Storage

- Ensure instruments are dry before storage, and stored in dry, clean conditions at an ambient room temperature.

Additional Information

- Other forms of cleaning (i.e. ultrasonic) and sterilization (i.e. Low temperature steam and Formaldehyde, Ethylene Oxide and Gas Plasma) are available. However, always follow the instructions for use as issued by the manufacturer and always consult with them if in any doubt over the suitability of any process used.
- Cleaning and sterilizing guidelines are available in HTM 2030 and HTM 2010. Contact: The NHS Estates Stationers Office Publications Cent for details at www.tsonline.gov.uk. For further information contact: NHS Estates Information Center, Department of Health, 1 Trevelyan Square, Boar Lane, Leeds, LS1 6AE, UK or visit www.nhsestates.gov.uk.

Note: It is the responsibility of the re-processor to ensure that the reprocessing as actually performed using equipment, materials and personnel in the reprocessing facility achieve the desired result. This requires validation and routine monitoring of the process. Likewise any deviation by the re-processor from the instructions provided must be properly evaluated for effectiveness and potential adverse consequences.



TECHNICAL TERMS TRANSLATION TABLE

English	German	French	Italian	Spanish
Accessories	Zubehör	Accessoires	Accessori	Accesorios
Adjustable	Verstellbar	Réglable	Adeguabile	Ajustable
Adult size	Erwachsengröße	Taille adulte	Misura Adulto	Tamaño adulto
Angled	Gewinkelt	Coudé	Piegato	Acodado
Arm	Arm	Bras	Braccio	Braso
Articulation	Gelenkverbindung	Articulation	Articolazione	Articulación
Atrauma	Atraumatisch	Atraumatique	Atraumatico	Atraumático
Ball Type	Kugelende	Embout sphérique	Puntale A Palla	Punta con bola
Blade	Blatt, Valve	Valve	Valva	Valva
Blunt	Stumpf	Mousse	Smusso	Romo
Bone	Knochen	Os	Ossa	Hueso
Bone rongeur	Knochenzange	Gouge	Sgorbia	Gubia
Child size	Kindergröße	Taille enfant	Misura Pediatrica	Tamaño niño
Circumflex	Zirkumflex	Circonflexe	Circonflesso	Circunflejo
Counterbalanced	Gegengewichtig	Contre poids	Contropeso	Contra peso
Curved	Gebogen	Courbe	Curvo	Curvo
Delicate	Ampfindlich	Délicat	Delicato	Delicado
Depth	Tiefe	Profondeur	Profondità	Profundidad
Dissecting	Sezierung	Dissection	Dissezione	Dissección
Dissector	Dissektor	Dissecteur	Dissettore	Dissector
External	Aussen Liegend	Externe	Esterno	Externo
Fine	Dünn, Fein	Fin	Fino	Fino
Fingerplate	Fingerplatte	Contrôle au doigt	Controllo Digitale	Control digital
Flat	Flach, Eben	Plat	Piatto	Plano
Forceps	Pinzette	Pince	Pinza	Pinza
Hand retractor	Handretraktor	Valve à main	Divaricatore A Mano	Separador a mano
Handle	Griff, Stiel	Manche	Manico	Mango
Height	Höhe	Hauteur	Altezza	Altura
Hook	Haken	Crochet	Gancio	Gancho
Infant	Kleinkind	Nourisson	Bambino	Niño de pecho
Jaws	Kinnbacken	Mors	Morso	Boca
Knot pusher	Schlingengabel	Pousse noeud	Stringinodo	Empujador de nudo
Large	Gross	Grand	Grande	Alto
Left	Links	Gauche	Sinistro	A la Izquierda
Length	Länge	Longueur	Lunghezza	Longitud
Ligature	Unterbindung	Ligature	Ligatura	Ligatura
Lung	Lunge	Poumon	Polmone	Pulmón
Medium	Mittel	Moyen	Medio	Medio
Multipurpose	Mehrzweck	Multi-fonctions	Funzione Multipla	Multi-función
Needle holder	Nadelhalter	Porte aiguille	Portaghi	Porta agujas
Needle pulling	Nadelaufnehmer	À saisir les aiguilles	Pinza Stringi Ago	Para coger las agujas
Newborn	Neugeborenen	Nouveau né	Neonato	Recién nacido
On Flat	Flach	Sur le plat	Piatto En	En el plano
Opening	Ö ffnung	Ouverture	Apertura	Apertura
Pair	Paar	Paire	Paia	Pár
Prong	Zinke	Griffe	Denti	Dientes
Rack	Gestell	Crémaillère	Cremagliera	Cremallera
Raspatory	Schabbeisen	Rugine	Raschiatoio	Raspador
Ratchet	Sperre	Crémaillère	Cremagliera	Cremallera
Retractor	Retraktor	Ecarteur	Divaricatore	Separador
Rib contractor	Rippenschliesser	Rapprocheur de côtes	Appaltatore DI Costole	Aproximador costal
Right	Rechts	Droite	Destra	A la derecha
Ring Handle	Ringgriff	A anneaux	Ad Anelli	Con anillos
Ring Tip	Ringspitze	Embout en anneau	Punta Ad Anelli	Punta con anillo
Rongeur	Knochenzange	Gouge	Sgorbia	Gubia
Round	Rund	Rond	Ton Do	Redondo
Scissors	Schere	Ciseaux	Forbici	Tijeras
Serrated	Gezähnt	Strié	Striato	Estriado
Shanks	Schenkel	Branches	Ramo	Mango
Sharp	Scharf	Acéré	Acute	Acerado
Small	Klein	Petit	Piccolo	Pequeño
Smooth	glatt	Lisse	Liscio	Liso
Spatula	Spatel	Spatule	Spatula	Espátula
Straight	Gerade	Droit	Dritto	Recto
Suction tube	Saugrohr	Canule d'aspiration	Canula DI Aspiraione	Cánula de aspiración
Suture passer	Suture passer	Tire-Fil	Passa-fili	Pasa-hilo
Teeth	Zähne	Dents	Denti	Dientes
Thermic purge	Thermische	Purgeur	Purgatore	Purgador
Thin	Dünn	Etroit	Ristretto	Estrecho
Thread	Faden, Zwirn	Torsade	Filo	Hilo
Tip	Spitze	Bout	Estremità	Punta
Tissue seizing	Gewebegrosse	Préhension	Preso	Presión
Twister	Dreher	Pince à torsader	Cerchiatura	Pinza para retorcer
Tying forceps	Binden	Dissection	Dissezione	Dissección
Vessel	Gefä	Vaisseau	Vaso	Vaso
Width	Breite / Weite	Largeur	Larghezza	Anchura
Wire Cutter	Drahtschneider	Coupe-Fils	Taglia Cavo	Alicata para cortar alambre
With / Without	Mit / Ohne	Avec / Sans	Con / Senza	Con / Sin



MEASUREMENTS, STANDARDS, AND CONVERSIONS

Millimeter Equivalents

MM = INCHES	MM = INCHES	MM = INCHES
.1 = .00384	29.0 = 1.14173	65.0 = 2.55905
.2 = .00787	30.0 = 1.18110	66.0 = 2.59842
.3 = .01181	31.0 = 1.22047	67.0 = 2.63779
.4 = .01575	32.0 = 1.25984	68.0 = 2.67716
.5 = .01968	33.0 = 1.29921	69.0 = 2.71653
.6 = .02362	34.0 = 1.33858	70.0 = 2.75590
.7 = .02756	35.0 = 1.37795	71.0 = 2.79527
.8 = .03149	36.0 = 1.41732	72.0 = 2.83464
.9 = .03543	37.0 = 1.45669	73.0 = 2.87401
1.0 = .03937	38.0 = 1.49606	74.0 = 2.91338
2.0 = .07874	38.1 = 1.5 in	75.0 = 2.95275
3.0 = .11811	39.0 = 1.53543	76.0 = 2.99212
4.0 = .15748	40.0 = 1.57480	76.2 = 3.0 in
5.0 = .19685	41.0 = 1.61417	77.0 = 3.03149
6.0 = .23622	42.0 = 1.65354	78.0 = 3.07056
7.0 = .27559	43.0 = 1.69291	79.0 = 3.11023
8.0 = .31496	44.0 = 1.73228	80.0 = 3.14960
9.0 = .35433	45.0 = 1.77165	81.0 = 3.18897
10.0 = .39370	46.0 = 1.81102	82.0 = 3.22834
11.0 = .43307	47.0 = 1.85039	83.0 = 3.26771
12.0 = .47244	48.0 = 1.88976	84.0 = 3.30708
12.7 = .5 in	49.0 = 1.92913	85.0 = 3.34645
13.0 = .51181	50.0 = 1.96350	86.0 = 3.38582
14.0 = .55118	50.8 = 2.0 in	87.0 = 3.42519
15.0 = .59055	51.0 = 2.00787	88.0 = 3.46456
16.0 = .62992	52.0 = 2.04724	88.9 = 3.5 in
17.0 = .66929	53.0 = 2.08661	89.0 = 3.50393
18.0 = .70866	54.0 = 2.12598	90.0 = 3.54330
19.0 = .74803	55.0 = 2.16535	91.0 = 3.58267
20.0 = .78740	56.0 = 2.20472	92.0 = 3.62204
21.0 = .82677	57.0 = 2.24409	93.0 = 3.66141
22.0 = .86614	58.0 = 2.28346	94.0 = 3.70078
23.0 = .90551	59.0 = 2.32283	95.0 = 3.74015
24.0 = .94488	60.0 = 2.36220	96.0 = 3.77952
25.0 = .98425	61.0 = 2.40157	97.0 = 3.81889
25.4 = 1.0 in	62.0 = 2.44094	98.0 = 3.85826
26.0 = 1.02362	63.0 = 2.48031	99.0 = 3.89763
27.0 = 1.06299	63.5 = 2.5 in	100.0 = 3.93700
28.0 = 1.10236	64.0 = 2.51968	101.6 = 4.0 in

Needle Tubing Equivalents



SIZE GAUGE NO.	APPROX. O.D. MM	INCHES
26	0.4	.018
24	0.5	.022
22	0.7	.028
20	0.9	.035
18	1.3	.053
16	1.6	.065
14	2.1	.083
12	2.8	.109
10	3.4	.134
8	4.2	.165
6	5.1	.203

Suction Tubing Equivalents

SIZE FRENCH GAUGE NO.	APPROX. O.D. MM	INCHES
3	1.0	.039
4	1.3	.053
5	1.7	.066
6	2.0	.079
7	2.3	.092
8	2.7	.105
9	3.0	.118
10	3.3	.131
11	3.7	.144
12	4.0	.158
13	4.3	.170
14	4.7	.184
15	5.0	.197
16	5.3	.210

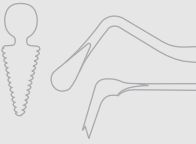

TABLE OF CONTENTS

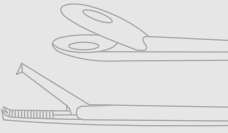
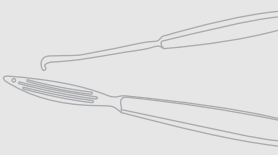
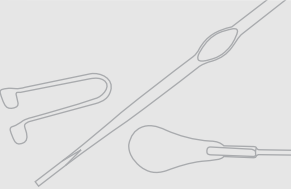
<p>66</p> <p>Oral Maxillo-facial Surgery Mund-, Kiefer- Und Gesichtschirurgie Cirugía Oral Y Maxilofacial Chirurgie Buccale Et Maxillo-faciale Chirurgia Maxillo-facciale</p>  <p>• Page • Seite • página • page • pagina 8-33</p>	<p>85</p> <p>Tonsillectomy, Laryngo-bronchoscopy Tonsillektomie, Laryngo-bronchoskopie Tonsilectomia, Laringo-bronchoscopia Tonsillectomie, Laryngo-bronchoscopie Tonsilectomia, Laringo-bronchoscopia</p>  <p>• Page • Seite • página • page • pagina 118-136</p>
<p>68</p> <p>Otology Instruments Otologie Otología Otologie Otologia</p>  <p>• Page • Seite • página • page • pagina 34-77</p>	<p>86</p> <p>Tracheotomy Instruments Tracheotomie Traqueotomía Trachéotomie Tracheotomia</p>  <p>• Page • Seite • página • page • pagina 137-142</p>
<p>74</p> <p>Rhinology Instruments Rhinologie Rinología Rhinologie Rinologia</p>  <p>• Page • Seite • página • page • pagina 78-117</p>	



ORAL MAXILLO-FACIAL SURGERY

Oral and maxillofacial surgery deals with a variety of conditions associated with the mouth, jaws, face and neck. Severe traumas and deformities do not only pose a risk to the function of the senses, but they often also entail psychosocial consequences.

This speciality encompasses the management of developmental facial anomalies including cleft lip and palate, facial trauma and surgery required in the management of orofacial malignancy. The scope of oral and maxillofacial surgery has widened over the last 15 years and continues to develop. An extensive array of procedures are performed, ranging from relatively minor surgery through to complex major head and neck surgery. There is a strong emphasis on reconstruction and operating in this emotionally and cosmetically sensitive area provides considerable clinical challenges.

SunMark presents a broad range of instruments for oral & maxillofacial surgery that help surgeons overcome clinical challenges in this speciality. Our range includes but is not limited to the mouth gags, oral and maxillofacial retractors, elevators, osteotomes, awls, bone separators, repositioning instruments and disimpaction instruments etc.

Mund-, Kiefer- und Gesichtschirurgie

Cirugía oral y maxilofacial

Chirurgie buccale et maxillo-faciale

Chirurgia maxillo-facciale

Finger Protectors, Mouth Gag
Finger-Protektoren, Mund-Gags
Protectores de dedo, Mordaza De la Boca
Protections de doigt, Bâillon De Bouche
Protezioni Finger, Bocca Bavaglio

Adams Napkin Holder

Consisting of Chain and Two Crocodile Forceps



Catalog #	Size
66-011-01	Standard

Langenbeck Finger Protector

Catalog #	Diameter
66-015-01	Ø 18.0 mm
66-015-02	Ø 21.0 mm
66-015-03	Ø 22.0 mm



Maunder Mouth Gag
Wood

Catalog #	Size
66-018-10	Standard



Heister Mouth Gag

Catalog #	Size
66-030-13	13 cm (5")



Obwegeser Mouth Gag

Catalog #	Size
66-032-11	11 cm (4 1/4")



INCHES
MILLIMETERS



Mouth Gag
Mund-Gags
Mordaza De la Boca
Bâillon De Bouche
Bocca Bavaglio

Molt Mouth Gag

Catalog #	Size
66-035-11	11 cm (4 1/4")
66-035-14	13 cm (5")



Denhart Mouth Gag

Catalog #	Size, Jaw Size
66-039-12	13 cm (5"), 16 mm



Roser-Koenig Mouth Gag

Catalog #	Size
66-041-16	16 cm (6 1/4")
66-041-20	20 cm (8")

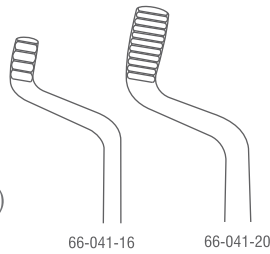

Fergusson-Ackland Mouth Gag

Catalog #	Size
66-043-18	14.5 cm (5 3/4")
66-043-20	18 cm (7")



Jennings Mouth Gag

Catalog #	Size
66-047-09	10.5 cm (4")
66-047-11	12.5 cm (5")
66-047-13	14.5 cm (5 3/4")
66-047-15	16.5 cm (6 1/2")



Mouth Gag
Mund-Gags
Mordaza De la Boca
Bâillon De Bouche
Bocca Bavaglio

Whitehead Mouth Gag
Without Tongue Depressor Ratchet

Catalog #	Size
66-049-11	11 cm (4 1/4")
66-049-13	13 cm (5")
66-049-15	15 cm (6")



Whitehead Mouth Gag
With Tongue Depressor Ratchet

Catalog #	Size
66-051-13	13 cm (5")



Negus Chest Support for Mouth Gag

Catalog #	Size
66-058-00	20 cm (8")



Kilner-Doughty Mouth Gag Complete
With 3 Tongue Depressors

Catalog #	Size
66-060-00	Standard



Kilner-Doughty Mouth Gag
Frame Only

Catalog #	Size
66-061-00	14.5 cm (5 3/4")





Mouth Gag
Mund-Gags
Mordaza De la Boca
Bâillon De Bouche
Bocca Bavaglio

Kilner-Doughty Tongue Depressor
Fenestrated Blade for Suction

Catalog #	Size, Blade Size
66-063-01	13.5 cm (5 1/4"), 70 x 29 mm
66-063-02	13.5 cm (5 1/4"), 80 x 34 mm
66-063-03	13.5 cm (5 1/4"), 85 x 38 mm



Davis-Boyle Mouth Gag Complete
With 5 Tongue Depressors Ref:- 66-073-01 to 66-073-05

Catalog #	Size
66-070-00	Standard



Davis-Boyle Mouth Gag
Frame Only

Catalog #	Size
66-071-00	Adult
66-071-01	Child



Davis-Boyle Tongue Depressor
With Fixed Suction Tube

Catalog #	Size, Blade Size
66-073-01	13.5 cm (5 1/4"), 110 x 26 mm
66-073-02	13.5 cm (5 1/4"), 95 x 25 mm
66-073-03	13.5 cm (5 1/4"), 80 x 24 mm
66-073-04	13.5 cm (5 1/4"), 65 x 23 mm
66-073-05	13.5 cm (5 1/4"), 30 x 20 mm

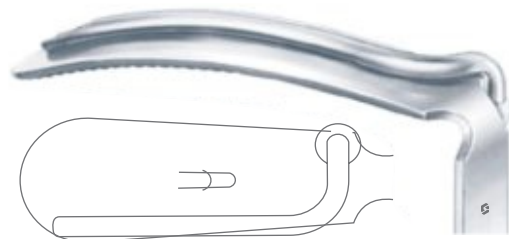

Davis-Boyle Tongue Depressor
With Suction Tube

Catalog #	Size, Blade Size
66-073-05	13.5 cm (5 1/4"), 30 x 20 mm



Mouth Gag
Mund-Gags
Mordaza De la Boca
Bâillon De Bouche
Bocca Bavaglio

Mclvor Mouth Gag Complete

With 3 Tongue Depressors Ref:- 66-083-01 to 66-083-03

Catalog #	Size
66-080-00	Standard



Mclvor Mouth Gag Frame Only

Catalog #	Size
66-081-00	15 cm (6")



Mclvor Tongue Depressor

Catalog #	Size, Blade Size
66-083-01	13.5 cm (5 1/4"), 100 x 26 mm
66-083-02	13.5 cm (5 1/4"), 85 x 25 mm
66-083-03	13.5 cm (5 1/4"), 75 x 23 mm



Dingmann Mouth Gag Complete

With 3 Tongue Depressors Ref:- 66-093-01 to 66-093-03

Catalog #	Size
66-090-00	Standard



Dingmann Mouth Gag

Catalog #	Size
66-091-00	14.5 cm (5 3/4")





Mouth Gag
Mund-Gags
Mordaza De la Boca
Bâillon De Bouche
Bocca Bavaglio

Dingmann Tongue Depressor

Catalog #	Size, Blade Size
66-093-01	13.5 cm (5 1/4"), 65 x 25 mm
66-093-02	13.5 cm (5 1/4"), 70 x 29 mm
66-093-03	13.5 cm (5 1/4"), 80 x 32 mm



Negus Tongue Depressor

Catalog #	Size, Blade Size
66-097-01	13.5 cm (5 1/4"), 70 x 20 mm
66-097-02	13.5 cm (5 1/4"), 80 x 30 mm
66-097-03	13.5 cm (5 1/4"), 95 x 35 mm



Russel-Davis Tongue Depressor

Catalog #	Size, Blade Size
66-099-01	13.5 cm (5 1/4"), 18 x 55 mm
66-099-02	13.5 cm (5 1/4"), 22 x 65 mm
66-099-03	13.5 cm (5 1/4"), 25 x 75 mm
66-099-04	13.5 cm (5 1/4"), 28 x 65 mm
66-099-05	13.5 cm (5 1/4"), 32 x 75 mm
66-099-06	13.5 cm (5 1/4"), 37 x 80 mm
66-099-07	13.5 cm (5 1/4"), 40 x 90 mm
66-099-08	13.5 cm (5 1/4"), 45 x 100 mm



Draffin Bipod Complete

Catalog #	Size, Detail
66-100-00	Standard, With 2 Draffin Bipod Rod Ref:- OM-100-48
66-100-01	40 cm (15 3/4"), Maguaran , Plate For Holding Draffin Bipod
66-100-48	48 cm (19"), Draffin Bipod Rod , With 4 Rings for Varying Height

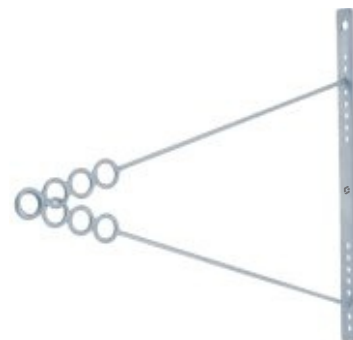

Lip and Cheek Retractors
 Lippen- und Wangenhalter
 Labios y Mejillas Retractores
 Lèvres et jougaux
 Labbra e guance Divaricatori

McKesson Mouth Prop

Catalog #	Profile
66-110-01	Small
66-110-02	Medium
66-110-03	Large

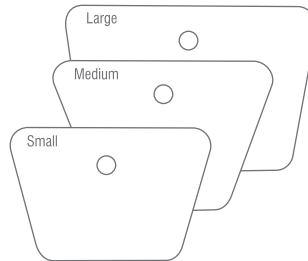

Martin-Simplex Lip and Cheek Retractor

Catalog #	Size
66-121-11	10 cm (4")



Obwegeser Lip and Cheek Retractor

Catalog #	Size
66-123-12	10 cm (4 3/4")



Bishop Lip and Cheek Retractor

Catalog #	Size, Blade Width
66-127-13	13.5 cm (5 1/4"), 27 mm



Cawood-Minnesota Cheek Retractor

Catalog #	Size, Blade Width
66-131-15	15 cm (6"), 20 mm





Tongue Depressors
Zungesenker
Bajalenguas
Abaisse-langue
Abbassalingua

Minnesota Cheek Retractor



Catalog # Size
66-135-14 14.5 cm (5 3/4")

Hartmann Tongue Depressor



Catalog # Size, Blade Size
66-141-15 15 cm (6"), 72 x 23 mm

Tobold Tongue Depressor

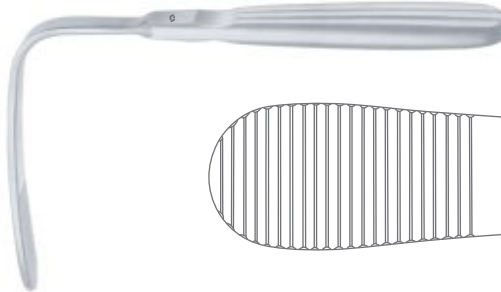

Catalog # Size, Blade Size
66-143-15 15 cm (6"), 88 x 25 mm

Andrew Tongue Depressor



Catalog # Size
66-145-14 14.5 cm (5 3/4")

Wieder Tongue Depressor



Catalog # Size, Blade Width
66-147-01 14 cm (5 1/2"), 36 mm
66-147-02 15 cm (6"), 43 mm

Tongue Depressors, Tongue Holding Forceps
Zungesenker, Zungehaltezaugen
Bajalenguas, Pinza tira-lengua
Abaisse-langue, Pincès tire-langue
Abbassalingua, Pinze per lingua

Standard Tongue Depressor



Catalog #	Size
66-151-14	14.5 cm (5 3/4")

Koenig Tongue Depressor



Catalog #	Size
66-153-15	15 cm (6")

Mayo Tongue Depressor



Catalog #	Size
66-155-17	17 cm (6 3/4")

Bruenings Tongue Depressor



Catalog #	Size, Blade Width 1 - Blade Width 2
66-159-19	19 cm (7 1/2"), 19 mm - 15 mm

Collin Tongue Holding Forcep



Catalog #	Size, Jaw Size
66-170-17	17 cm (6 3/4"), 24 x 27 mm





Tongue Holding Forceps
Zungehaltezaugen
Pinza tira-lengua
Pincès tire-langue
Pinze per lingua

Young Tongue Holding Forcep



Catalog #	Size
66-173-17	15 cm (6")

Henahan Retractor



Catalog #	Size, Profile
66-201-01	18 cm (7"), Fig. 1
66-201-02	18 cm (7"), Fig. 2
66-201-03	18 cm (7"), Fig. 3



Sigmoid Notch Extra Oral Retractor
Concave Blade Full Bent Tip

Catalog #	Size, Blade Size
66-251-24	22 cm (8 3/4"), 9.5 mm x 16 mm



Petri Intra Oral Retractor
For LeFort Osteotomies

Catalog #	Size, Blade Width
66-255-24	23 cm (9"), 25.5 mm



Bauer Intra Oral Retractor
Left

Catalog #	Size
66-259-21	21 cm (8 1/4")



Oral Retractors
Orale Wundhaken
Separadores orales
Rétracteurs orales
Divaricatori orali

Bauer Intra Oral Retractor
Right



Catalog #	Size
66-261-21	21 cm (8 ¼")

Levasseur-Merrill Intra Oral Retractor



Catalog #	Size
66-265-25	25 cm (9 ¾")

Obwegeser Soft Tissue Retractor
Bent Upwards



Catalog #	Size, Blade Size
66-271-16	24 cm (9 ½"), 5 x 16 mm
66-271-25	24 cm (9 ½"), 7 x 25 mm
66-271-35	24 cm (9 ½"), 10 x 35 mm
66-271-42	24 cm (9 ½"), 10 x 42 mm
66-271-55	24 cm (9 ½"), 12 x 55 mm
66-271-70	24 cm (9 ½"), 14 x 70 mm
66-271-80	24 cm (9 ½"), 16 x 80 mm

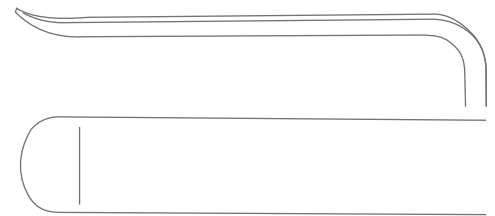

Obwegeser Soft Tissue Retractor
Bent Downwards



Catalog #	Size, Blade Size
66-273-16	24 cm (9 ½"), 5 x 16 mm
66-273-25	24 cm (9 ½"), 7 x 25 mm
66-273-35	24 cm (9 ½"), 10 x 35 mm
66-273-42	24 cm (9 ½"), 10 x 42 mm
66-273-55	24 cm (9 ½"), 12 x 55 mm
66-273-70	24 cm (9 ½"), 14 x 70 mm
66-273-80	24 cm (9 ½"), 16 x 80 mm

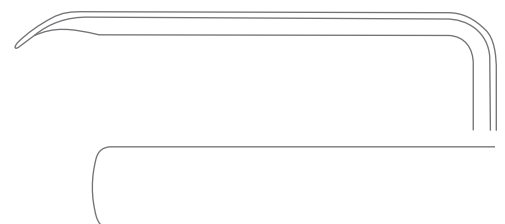



Soft Tissue Retractors
Weichteilhaken
Separadores de tejidos blandos
Rétracteurs des tissus mous
Divaricatori tessuti molli

Obwegeser Soft Tissue Retractor
Bent Upwards

Catalog #	Size, Blade Size
66-275-43	21.5 cm (8 1/2"), 11 x 43 mm
66-275-57	21.5 cm (8 1/2"), 11 x 57 mm
66-275-83	21.5 cm (8 1/2"), 16 x 83 mm

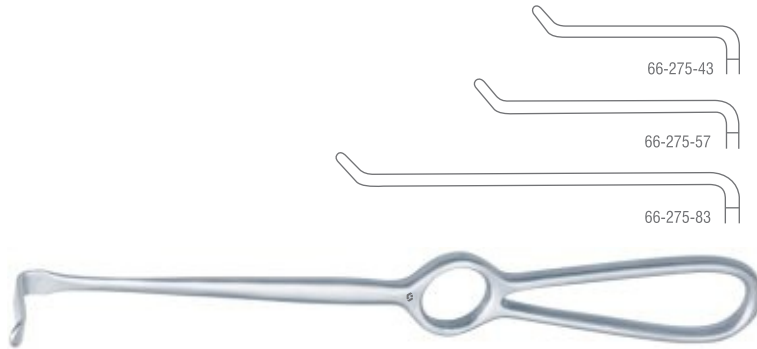

Obwegeser Mandibular Retractor

Catalog #	Size, Blade Size
66-279-30	21 cm (8 1/4"), 12 x 30 mm
66-279-45	21 cm (8 1/4"), 12 x 45 mm
66-279-60	21 cm (8 1/4"), 12 x 60 mm

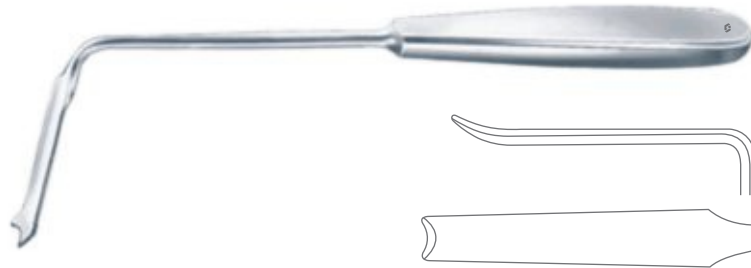

Obwegeser Ramus Retractor

Catalog #	Size, Blade Size
66-281-22	24.5 cm (9 3/4"), 15 x 70 mm



Obwegeser Ramus Retractor

Catalog #	Size, Blade Size
66-283-22	24.5 cm (9 3/4"), 22 x 70 mm



Obwegeser Ramus Retractor (Nasal Spine Retractor)

Catalog #	Size, Blade Size
66-287-22	22 cm (8 3/4"), 45 x 10 mm



Oral Retractors
Orale Wundhaken
Separadores orales
Rétracteurs orales
Divaricatori orali

Obwegeser Ramus Retractor



Catalog #	Size, Blade Size
66-289-22	22 cm (8 3/4"), 72 x 10 mm



Steinhauser Zygomatic Retractor



Catalog #	Size, Profile
66-291-01	24 cm (9 1/2"), Right
66-291-02	24 cm (9 1/2"), Left



66-291-01



66-291-02

Obwegeser Chin Retractor



Catalog #	Size
66-301-16	16.5 cm (6 1/2")

Obwegeser Channel Retractor



Catalog #	Size, Blade Width
66-305-08	17 cm (6 3/4"), 8 mm
66-305-10	17 cm (6 3/4"), 10 mm

Hargis Medial Ramus Retractor

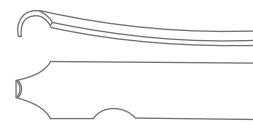
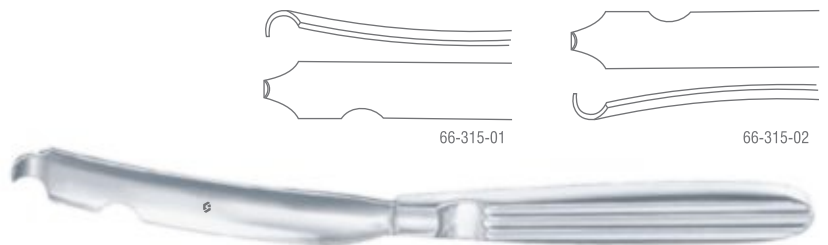

66-315-01

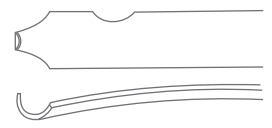

66-315-02

Catalog #	Size, Profile
66-315-01	19.5 cm (7 3/4"), Right
66-315-02	19.5 cm (7 3/4"), Left





Oral Retractors, Periosteal Elevator
Orale Wundhaken, Raspatorium
Separadores orales, Elevador perióstico
Rétracteurs orales, Ascenseur périostée
Divaricatori orali, Scollaperiostio

Hargis Mandibular Body Retractor

Catalog #	Size
66-319-18	18 cm (7")

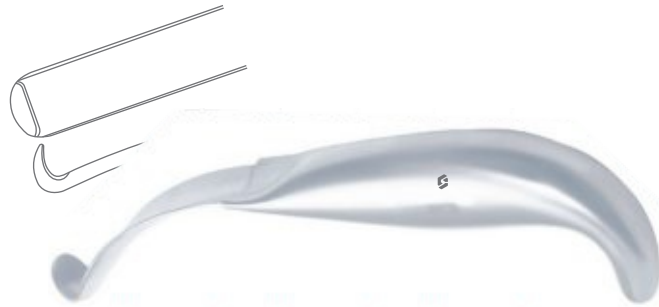

Hargis Anterior Border Stripper

Catalog #	Size
66-331-19	19 cm (7 1/2")



**Hargis Periosteal Elevator
Right**

Catalog #	Size, Width
66-333-06	23 cm (9"), 6.5 mm
66-333-09	23 cm (9"), 9.0 mm

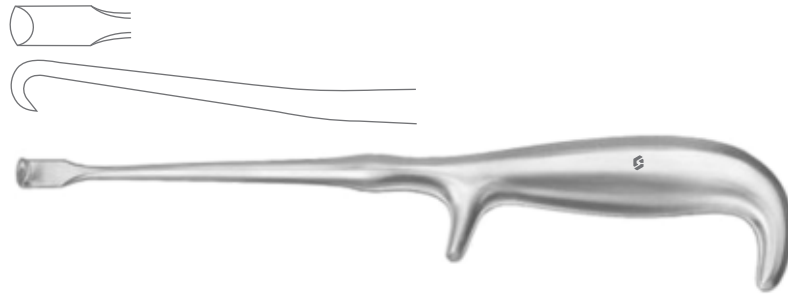

**Hargis Periosteal Elevator
Left**

Catalog #	Size, Width
66-335-06	23 cm (9"), 6.5 mm
66-335-09	23 cm (9"), 9.0 mm

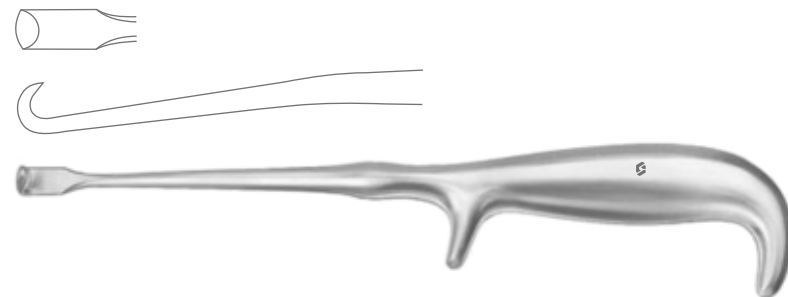

Hargis Periform Rim Retractor

Catalog #	Size, Width
66-337-18	18.5 cm (7 1/4")



Periosteal Elevator
Raspatorium
Elevador perióstico
Ascenseur périostée
Scollaperiostio

Hargis Pterygoid Osteotome



Catalog #	Size, Width
66-339-22	22 cm (8 3/4")

**Hargis Bone Holding Forcep
With Chain**

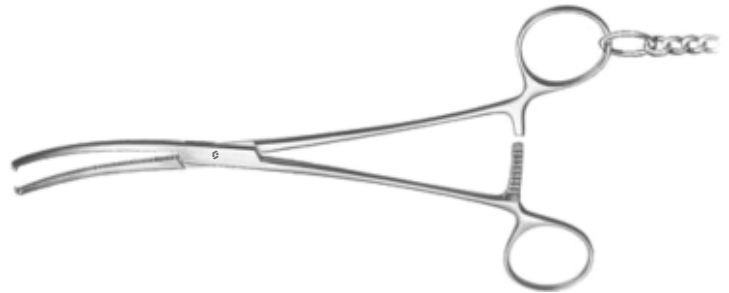

Catalog #	Size, Width
66-341-19	19 cm (8")

Obwegeser Periosteal Elevator

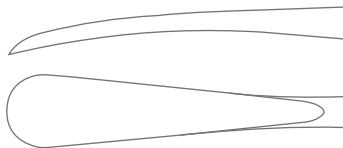

Catalog #	Size, Blade Width
66-361-04	17.5 cm (7"), 4 mm
66-361-06	17.5 cm (7"), 6 mm
66-361-07	17.5 cm (7"), 7 mm
66-361-09	17.5 cm (7"), 9 mm
66-361-11	17.5 cm (7"), 11 mm



**Obwegeser Elevator
Fig. 1**



Catalog #	Size
66-381-21	20.5 cm (8")



**Obwegeser Elevator
Fig. 2**

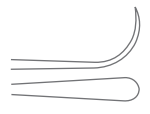

Catalog #	Size
66-383-21	20.5 cm (8")

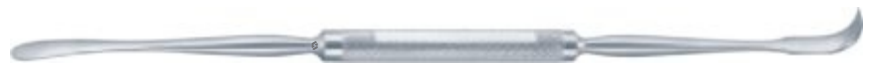



Periosteal Elevator
Raspatorium
Elevador perióstico
Ascenseur périostée
Scollaperiostio

Obwegeser J-Stripper

Catalog #	Size, Blade Width
66-401-05	20.5 cm (8"), 5 mm
66-401-07	20.5 cm (8"), 7 mm
66-401-09	20.5 cm (8"), 9 mm



Obwegeser Ramus Stripper

Catalog #	Size, Profile
66-405-01	17.5 cm (7"), Fig. 1
66-405-02	17.5 cm (7"), Fig. 2



Terry Ramus Pusher

Catalog #	Size
66-415-24	24 cm (9 1/2")



Steinhauser Reposition Instrument

Catalog #	Size
66-421-18	18 cm (7")



Tatum Sinus Lift Curette
Fig. 1

Catalog #	Size, Blade Width
66-451-01	18 cm (7"), 2.6 mm - 2.6 mm





Sinus Lift Currettes
Sinus Lift Küretten
Curetas Sinus Lift
Currettes Sinus Lift
Curette rialzo del seno

Tatum Sinus Lift Curette
Fig. 2



Catalog # Size, Blade Width
66-453-02 17.5 cm (7"), 2.6 mm - 2.6 mm

Tatum Sinus Lift Curette
Fig. 3



Catalog # Size, Blade Width
66-455-03 18 cm (7"), 4.1 mm - 4.1 mm

Tatum Sinus Lift Curette
Fig. 4



Catalog # Size, Blade Width
66-457-04 18.5 cm (7 1/4"), 4.1 mm - 4.1 mm

Tatum Sinus Lift Curette
Fig. 5



Catalog # Size, Blade Width
66-459-05 18.5 cm (7 1/4"), 6.7 mm - 6.7 mm

Tatum Sinus Lift Curette
Fig. 6

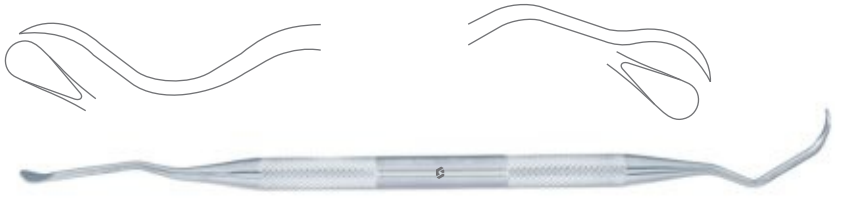

Catalog # Size, Blade Width
66-461-06 19 cm (7 1/2"), 6.7 mm - 6.7 mm

INCHES
MILLIMETERS



Sinus Lift Curettes, Maxillary Awls
Sinus Lift Küretten, Unterkieferahlen
Curetas Sinus Lift, Leznas Maxilares
Curettes Sinus Lift, Alênes maxillaires
Curette rialzo del seno, Punteruoli mascellari

Tatum Sinus Lift Curette
Fig. 7



Catalog # Size, Blade Width
66-463-07 16 cm (6 1/4"), 2.8 mm - 6.2 mm

Tatum Sinus Lift Curette
Fig. 8



Catalog # Size, Blade Width
66-465-08 16 cm (6 1/4"), 2.8 mm - 6.2 mm

Tatum Sinus Lift Curette
Fig. 9



Catalog # Size, Blade Width
66-467-09 15 cm (6"), 3.1 mm - 3.1 mm

Tatum Sinus Lift Curette
Fig. 10



Catalog # Size, Blade Width
66-469-10 17 cm (6 3/4"), 5.6 mm - 5.6 mm

Obwegeser Maxillary Awl



66-501-15

66-501-17



Catalog # Size
66-501-15 15 cm (6")
66-501-17 17.5 cm (7")

Sinus Lift Curettes, Sagittal Split Separators, Ramus Separator
 Sinus Lift Küretten, Sagittalspreizer, Spreizzange
 Curetas Sinus Lift, Separadores sagitales, Pinza para separar la rama
 Curettes Sinus Lift, Ecarteurs sagitaux, Pince pour séparer ramus
 Curette rialzo del seno, Separatori sagittali, Pinza per separare il ramo

Obwegeser Zygomatic Arch Awl



Catalog #	Size
66-503-24	24 cm (9 1/2")

Obwegeser Maxillary Awl



Catalog #	Size
66-507-18	18 cm (7")

Obwegeser Wire Loop Forcep



Catalog #	Size
66-540-15	15 cm (6")

Smith Ramus Separator

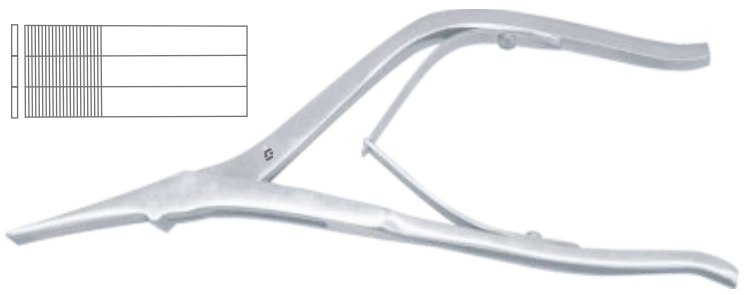

Catalog #	Size
66-550-20	23.5 cm (9 1/4")

Smith Sagittal Split Separator

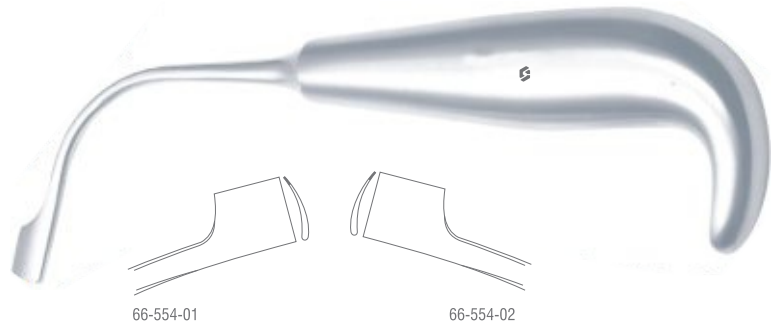

Catalog #	Size, Profile
66-554-01	18.5 cm (7 1/4"), Right
66-554-02	18.5 cm (7 1/4"), Left

66-554-01

66-554-02



Disimpaction Forcep, Zygoma Elevators
Repositionszangen, Zygoma-Elevatorien
Pinzas para reposición, Elevadores, cigomáticos
Pinces de reposition, Elévateurs zygommatiques
pinze per riduzione, Elevatori per zigomo

Rowe Disimpaction Forcep



Catalog # Size, Profile
66-570-01 22.5 cm (8 ¾"), Left

Rowe Disimpaction Forcep



Catalog # Size, Profile
66-570-02 22.5 cm (8 ¾"), Right

Gillies Zygoma Elevator

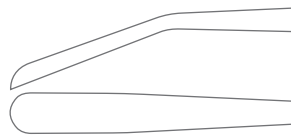

Catalog # Size
66-601-21 20 cm (8")

Dingmann Zygoma Elevator



Catalog # Size, Tip Diameter
66-602-21 21 cm (8 ¼"), Ø 5.0 mm

Rowe Zygoma Elevator



Catalog # Size
66-605-21 21.5 cm (8 ½")



Osteotomes
Osteotome
Osteótomos
Ostéotomes
Osteotomi

Boise Nasal Fracture Elevator



Catalog #	Size, Tip Size
66-607-19	19.5 cm (7 3/4")

Dingman Bone Hook

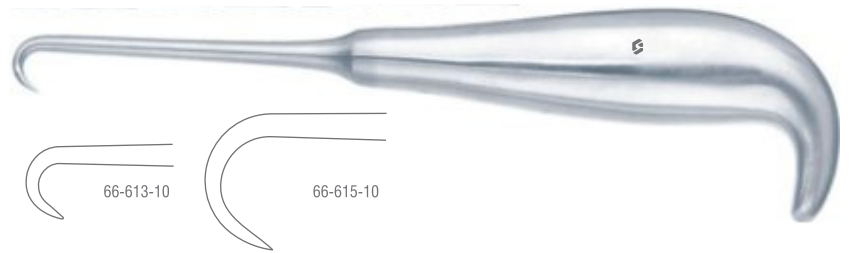

Catalog #	Size, Tip Size
66-613-10	20 cm (8"), 10 mm
66-615-10	20 cm (8"), 20 mm

**Bauer Osteotome
Straight**



Catalog #	Size, Width
66-620-06	20.5 cm (8"), 6 mm
66-620-08	20.5 cm (8"), 8 mm

**Bauer Osteotome
Curved**



Catalog #	Size, Width
66-621-06	20.5 cm (8"), 6 mm
66-621-08	20.5 cm (8"), 8 mm

**Epker-Bauer Osteotome
Curved**



Catalog #	Size, Width
66-623-08	17.5 cm (7"), 8 mm



Dautrey-Munro Osteotome

Catalog #	Size, Width
66-626-04	16 cm (6 1/4"), 4.0 mm
66-626-06	16 cm (6 1/4"), 6.0 mm
66-626-08	16 cm (6 1/4"), 8.0 mm
66-626-10	16 cm (6 1/4"), 10.0 mm
66-626-12	16 cm (6 1/4"), 12.0 mm
66-626-14	16 cm (6 1/4"), 14.0 mm
66-626-16	16 cm (6 1/4"), 16.0 mm



Dunn-Dautrey Osteotome

Straight

Catalog #	Size, Width
66-628-04	16.5 cm (6 1/2"), 4.0 mm
66-628-06	16 cm (6 1/4"), 6.0 mm
66-628-08	16 cm (6 1/4"), 8.0 mm



Dunn-Dautrey Osteotome

Slightly Curved

Catalog #	Size, Width
66-629-06	16 cm (6 1/4"), 6.0 mm

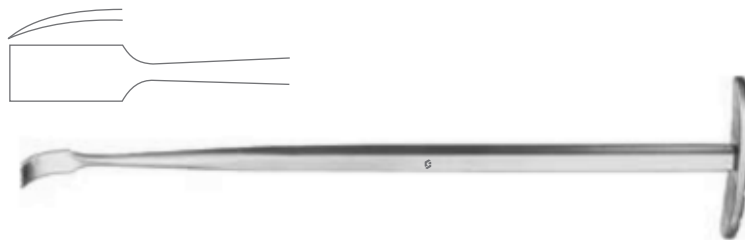

Dunn-Dautrey Osteotome

Strongly Curved

Catalog #	Size, Width
66-631-06	16 cm (6 1/4"), 6.0 mm

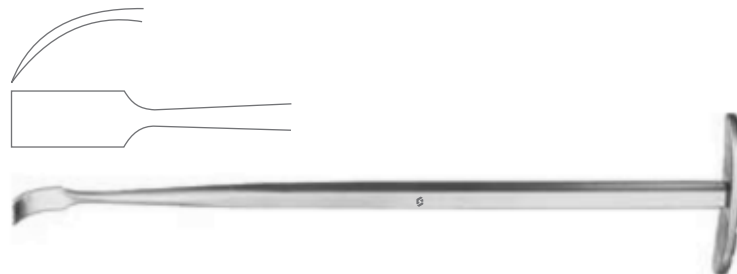

Maxillofacial Instruments
MKG-Instrumente
Instrumentos Maxilofaciales
Instruments Maxilla
Maxillofacciali Instruments

Dunn-Dautrey Elevator



Catalog #	Size, Blade Size
66-633-48	15.5 cm (6"), 6 x 48 mm
66-633-56	15.5 cm (6"), 6 x 56 mm

Dolwick-Type TMJ Disc Clamp



Catalog #	Size
66-637-12	12 cm (4 3/4")

Dolwick-Type TMJ Condylar Retractor



Catalog #	Size
66-639-14	14.5 cm (5 1/2")

Dolwick-Type TMJ Elevator



Catalog #	Size
66-641-17	16 cm (6 3/4")

Turvey Palatal Expander



Catalog #	Size
66-700-17	17 cm (6 3/4")

INCHES
MILLIMETERS



Terry Septal Osteotome

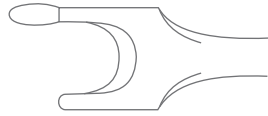

Catalog #	Size
66-730-19	19 cm (7 1/2")

Obwegeser Septonasal Osteotome
Graduated

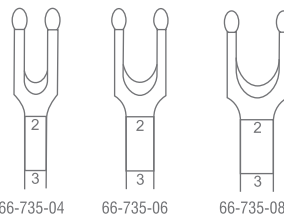

Catalog #	Size, Blade Width
66-735-04	18.5 cm (7 1/4"), 4 mm
66-735-06	18.5 cm (7 1/4"), 6 mm
66-735-08	18.5 cm (7 1/4"), 8 mm

FiberGrip™ Obwegeser Wedge Osteotome

FIBERGrip

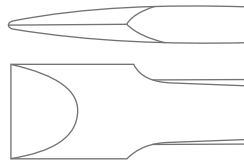

Catalog #	Size, Blade Width
66-740-08	22 cm (8 3/4"), 8 mm
66-740-12	22 cm (8 3/4"), 12 mm
66-747-16	22 cm (8 3/4"), 16 mm

FiberGrip™ Obwegeser Split Osteotome

FIBERGrip

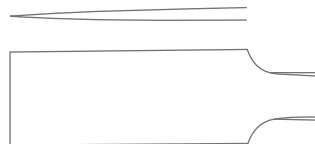

Catalog #	Size, Blade Width
66-742-08	22 cm (8 3/4"), 8 mm
66-742-12	22 cm (8 3/4"), 12 mm
66-742-16	22 cm (8 3/4"), 16 mm
66-742-20	22 cm (8 3/4"), 20 mm

Mark Of Quality



SUNMARK
INSTRUMENTS

Osteotomes
Osteotome
Osteótomos
Ostéotomes
Osteotomi

Obwegeser Osteotome
For Alveolar Process

Catalog #	Size, Blade Width
66-750-03	15 cm (6"), 3 mm
66-750-04	15 cm (6"), 4 mm
66-750-06	15 cm (6"), 6 mm



INCHES
MILLIMETERS



OTOLOGY INSTRUMENTS

SunMark Otology Instruments provide innovative tools for a broad range of otology procedures, as well as neurology and lateral skull base surgeries.

SunMark instruments manufactures a range of otology instruments for this branch of medicine including but not limited to the following ear speculums, tuning forks, ear catheters, ear polypus snares, ear forceps, ear polypus forceps, alligator forceps, micro alligator forceps, micro ear scissors, micro ear knives, micro ear needles, ear picks, ear hooks, micro ear instruments, micro ear curettes, ear curettes, scoops, loops, ear hooks, Tympanum needles and knives, periosteal elevators, foreign body levers, mastoid rongeurs and ear syringes.

Otologie

Otologia

Otologie

Otologia



Ear Specula
Ohrspekula
Espéculos auriculares
Spéculums auriculaires
Specoli auricolari

Hartmann Ear Specula
Set of 3 Ref: 68-012-00 to 68-012-02

Catalog #	Size
68-010-01	Standard



Hartmann Ear Specula
Set of 3 Ref: 68-012-02 to 68-012-04

Catalog #	Size
68-010-02	Standard



Hartmann Ear Specula
Set of 3 Ref: 68-012-01 to 68-012-04

Catalog #	Size
68-010-03	Standard



Hartmann Ear Specula
Set of 3 Ref: 68-012-00 to 68-012-04

Catalog #	Size
68-010-03	Standard



Hartmann Ear Speculum

Catalog #	Size, Diameter, Profile
68-012-00	3.6 cm (1 1/2"), Ø 3.0 mm, Fig. 0
68-012-01	3.6 cm (1 1/2"), Ø 4.0 mm, Fig. 1
68-012-02	3.6 cm (1 1/2"), Ø 5.0 mm, Fig. 2
68-012-03	3.6 cm (1 1/2"), Ø 6.0 mm, Fig. 3
68-012-04	3.6 cm (1 1/2"), Ø 7.0 mm, Fig. 4





Ear Specula
Ohrspekula
Espéculos auriculares
Spéculums auriculaires
Specoli auricolari

Toynbee Ear Specula

Set of 3 Ref: 68-022-02 to 68-022-04

Catalog #	Size
68-020-01	Standard



Toynbee Ear Specula

Set of 4 Ref: 68-022-01 to 68-022-04

Catalog #	Size
68-020-02	Standard



Toynbee Ear Speculum

For Adults

Catalog #	Size
68-022-01	3.6 cm (1 1/2"), Ø 4.0 mm, Fig. 1
68-022-02	3.6 cm (1 1/2"), Ø 5.0 mm, Fig. 2
68-022-03	3.6 cm (1 1/2"), Ø 6.0 mm, Fig. 3
68-022-04	3.6 cm (1 1/2"), Ø 7.0 mm, Fig. 4



Hartmann Ear Specula (Black)

Set of 3 Ref: 68-032-00 to 68-032-02

Catalog #	Size
68-030-01	Standard



Hartmann Ear Specula (Black)

Set of 3 Ref: 68-032-02 to 68-032-04

Catalog #	Size
68-030-02	Standard



Ear Specula
Ohrspekula
Espéculos auriculares
Spéculems auriculaires
Specoli auricolari

Hartmann Ear Specula (Black)
Set of 4 Ref: 68-032-01 to 68-032-04

Catalog #	Size
68-030-03	Standard



Hartmann Ear Speculum
Black

Catalog #	Size, Profile
68-032-00	3.6 cm (1 1/2"), Fig. 0
68-032-01	3.6 cm (1 1/2"), Fig. 1
68-032-02	3.6 cm (1 1/2"), Fig. 2
68-032-03	3.6 cm (1 1/2"), Fig. 3
68-032-04	3.6 cm (1 1/2"), Fig. 4



Zoellner Ear Specula
Set of 6 Ref: 68-042-01 to 68-042-06

Catalog #	Size
68-040-01	Standard

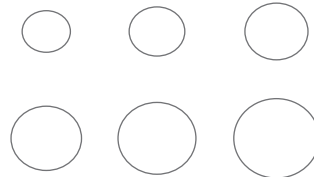

Zoellner Ear Speculum
Oval, Black

Catalog #	Size, Tip Size, Profile
68-042-01	3.8 cm (1 1/2"), 5.5 x 6.5 mm. Fig. 1
68-042-02	3.8 cm (1 1/2"), 6.5 x 7.5 mm. Fig. 2
68-042-03	3.8 cm (1 1/2"), 7.5 x 8.5 mm. Fig. 3
68-042-04	3.8 cm (1 1/2"), 8.5 x 9.5 mm. Fig. 4
68-042-05	3.8 cm (1 1/2"), 9.5 x 10.5 mm. Fig. 5
68-042-06	3.8 cm (1 1/2"), 10.5 x 11.5 mm. Fig. 6

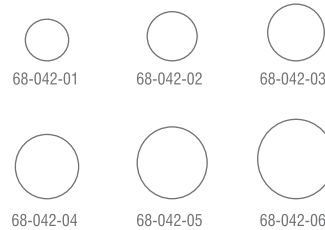



Ear Specula
Ohrspekula
Espéculos auriculares
Spéculums auriculaires
Specoli auricolari

Farrior Ear Specula

Set of 7 Ref: 68-052-01 to 68-052-07

Catalog #	Size
68-050-01	Standard



Farrior Ear Speculum

Black

Catalog #	Size, Diameter, Profile
68-052-01	3.6 cm (1 1/2"), Ø 5.5 mm, Fig. 1
68-052-02	3.6 cm (1 1/2"), Ø 6.5 mm, Fig. 2
68-052-03	3.6 cm (1 1/2"), Ø 7.5 mm, Fig. 3
68-052-04	3.6 cm (1 1/2"), Ø 8.5 mm, Fig. 4
68-052-05	3.6 cm (1 1/2"), Ø 9.5 mm, Fig. 5
68-052-06	3.6 cm (1 1/2"), Ø 10.5 mm, Fig. 6
68-052-07	3.6 cm (1 1/2"), Ø 11.5 mm, Fig. 7

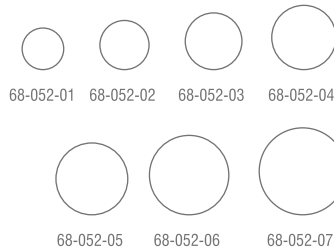

Storage Rack for Ear Specula

For 12 Specula

Catalog #	Size
68-060-12	Standard



Richnau-Holmgren Ear Speculum

Catalog #	Diameter
68-064-02	Ø 2.0 mm
68-064-04	Ø 3.0 mm
68-064-06	Ø 4.0 mm



Ear Specula, Tuning Forks
Ohrspekula, Stimmgabeln
Espéculos auriculares, Diapasónes
Spéculums auriculaires, Diapasons
Specoli auricolari, Diapason

Siegle Otoscope Complete

With 3 Specula Ref: 68-072-01 to 68-072-03

Catalog #	Size
68-070-00	Standard



Siegle Ear Speculum

Catalog #	Diameter, Profile
68-072-01	Ø 6.5 mm, Fig. 1
68-072-02	Ø 7.0 mm, Fig. 2
68-072-03	Ø 8.0 mm, Fig. 3



Hartmann Tuning Forks

Set of 5 Ref: 68-102-03 to 68-102-05 and 68-104-04 to 68-104-05

Catalog #	Size
68-100-10	Standard



Hartmann Tuning Forks

Set of 6 Ref:- 68-102-03 to 68-102-06 and 68-104-04 to 68-104-05

Catalog #	Size
68-100-20	Standard



Hartmann Tuning Forks

Set of 6 Ref:- 68-102-03 to 68-102-06 and 68-104-02 to 68-104-05

Catalog #	Size
68-100-30	Standard





Hartmann Tuning Fork

Catalog #	Frequency
68-102-01	C 128
68-102-02	C256
68-102-03	C512
68-102-04	C1024
68-102-05	C2048
68-102-06	C4096



Hartmann Tuning Fork (French)

Catalog #	Frequency
68-104-01	C16
68-104-02	C32
68-104-03	C64
68-104-04	C128
68-104-05	C256



Tuning Forks

Set of 5 Ref:- 68-112-02 to 68-112-06

Catalog #	Size
68-110-00	Standard





Tuning Forks
Stimmgabeln
Diapasónes
Diapasons
Diapason

Tuning Fork

Catalog #	Frequency
68-112-02	C 128
68-112-03	C256
68-112-04?	C512
68-112-05	C1024
68-112-06	C2048



Lucae Tuning Fork

Catalog #	Frequency
68-122-01	C 128
68-122-02	C256
68-122-03	C512
68-122-04?	C1024
68-122-05	C2048
68-122-06	C4096



Lucae Tuning Fork
Moveable Up to h

Catalog #	Frequency
68-126-00	C 128



Hartmann Tuning Fork
Moveable up to h

Catalog #	Frequency
68-128-00	C 128





Hartmann Tuning Fork



Catalog #	Frequency
68-130-00	C'256

Rydel-Seiffer Tuning Fork
Also for Neurology

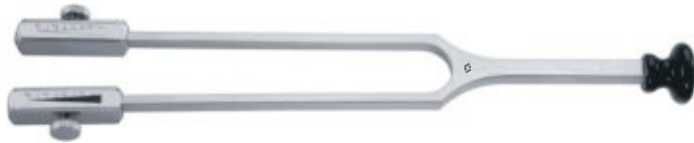

Catalog #	Frequency With Dampers, Frequency Without Dampers
68-134-00	C 64 , C 128

Neuro Tuning Fork
With Hammer, Pinwheel, Brush and Needle



Catalog #	Frequency
68-136-00	Standard

Koenig Tuning Fork
Moveable Up to g



Catalog #	Frequency
68-138-00	A 109

Tuning Fork



Catalog #	Frequency
68-140-00	a440

Ear Catheters, Polypus Snares
Ohrkatheter, Polypenschnürer
Sondas auriculares, Polipótomos
Sondes auriculaires, Serre-noeuds
Sonde auricolari, Serranodi

Hartmann Ear Catheter



Catalog #	Size, Profile
68-150-01	15 cm (6"), Fig. 1
68-150-02	15 cm (6"), Fig. 2
68-150-03	15 cm (6"), Fig. 3

**Krause Polypus Snare
Open Tip**



Catalog #	Size
68-161-18	18.5 cm (7 1/4")

**Krause-Voss Polypus Snare
Close Tip**



Catalog #	Size
68-163-18	18.5 cm (7 1/4")

Lange-Wilde Polypus Snare



Catalog #	Size
68-165-16	16 cm (6 1/4")

Snare Wire



Catalog #	Size, Diameter
68-170-30	100 cm (39 1/2"), Ø 0.3 mm
68-170-40	100 cm (39 1/2"), Ø 0.4 mm

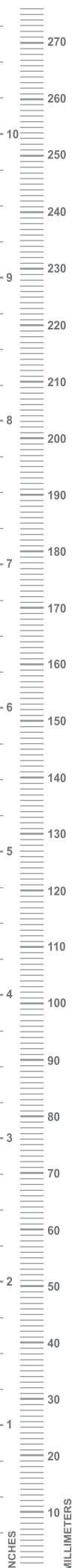



Ear Forceps, Ear Polypus Forceps
Ohrpinzetten, Ohrpolypenzangen
Pinzas auriculares, Pinzas para pólipos auriculares
Pincès auriculaires, Pincès pour polypes auriculaires
Pinze auricolari, Pinze per polipi auricolari

Troeltsch (Wilde) Ear Forcep

Catalog #	Size
68-201-11	11 cm (4 3/4")
68-201-13	12.5cm (5")



Troeltsch (Wilde) Ear Forcep

Catalog #	Size
68-203-11	11 cm (4 3/4")



Troeltsch (Wilde) Ear Forcep
1 x 2 Teeth

Catalog #	Size
68-205-11	11 cm (4 3/4")



Adson Ear Forcep
Bayonet Shaped

Catalog #	Size
68-207-18	17.5 cm (7")



Gruenwald (Lucae) Ear Forcep
Bayonet Shaped

Catalog #	Size
68-211-14	14.5 cm (5 3/4")



Ear Forceps, Ear Polypus Forceps
Ohrpinzetten, Ohrpolypenzangen
Pinzas auriculares, Pinzas para pólipos auriculares
Pinces auriculaires, Pinces pour polypes auriculaires
Pinze auricolari, Pinze per polipi auricolari

Jansen Ear Forcep
Bayonet Shaped

Catalog #	Size
68-213-16	16 cm (6 1/4")
68-213-21	21.5 cm (8 1/2")



Gruenwald (Lucae) Ear Forcep
1 x 2 Teeth, Bayonet Shaped

Catalog #	Size
68-215-14	14.5 cm (5 3/4")



Littauer Ear Polypus Forcep

Catalog #	Size
68-221-10	10 cm (4")



Hartmann Ear Polypus Forcep
Fine Model

Catalog #	Size
68-223-12	12 cm (4 3/4")



Hartmann Ear Polypus Forcep
Regular Model

Catalog #	Size
68-225-14	14 cm (5 1/2")





Ear Forceps, Ear Polypus Forceps
Ohrpinzetten, Ohrpolypenzangen
Pinzas auriculares, Pinzas para pólipos auriculares
Pincès auriculaires, Pincès pour polypes auriculaires
Pinze auricolari, Pinze per polipi auricolari

Tilley Ear Polypus Forcep

Catalog #	Size
68-229-14	14 cm (5 1/2")
68-229-16	16 cm (6 1/4")



Buck Foreign Body Forcep

Catalog #	Size
68-235-11	11.5 cm (4 1/2")



Quire Foreign Body Forcep

Catalog #	Size
68-237-10	10.5 cm (4")



Hartmann-Wullstein Alligator Forcep

Catalog #	Size
68-251-08	8.5 cm (3 1/4")



**Hartmann-Wullstein Alligator Forcep
Cup Shaped**

Catalog #	Size, Diameter
68-253-08	8.5 cm (3 1/4"), Ø 1.0 mm



Ear Forceps, Ear Polypus Forceps
Ohrpinzetten, Ohrpolypenzangen
Pinzas auriculares, Pinzas para pólipos auriculares
Pincas auriculaires, Pincas pour polypes auriculaires
Pinze auricolari, Pinze per polipi auricolari

Hartmann Alligator Forcep



Catalog #	Size
68-255-08	8.5 cm (3 1/4")
68-255-14	14 cm (5 1/2")
68-255-16	16 cm (6 1/4")

Hartmann Alligator Forcep

1 x 2 Teeth



Catalog #	Size
68-257-08	8.5 cm (3 1/4")
68-257-14	14 cm (5 1/2")

Hartmann Alligator Forcep

Cup Shaped



Catalog #	Size, Diameter
68-261-20	8.5 cm (3 1/4"), Ø 2.0 mm
68-261-25	8.5 cm (3 1/4"), Ø 2.5 mm
68-261-30	8.5 cm (3 1/4"), Ø 3.0 mm

Hartmann Alligator Forcep

Bent Upwards, Cup Shaped



Catalog #	Size, Diameter
68-263-20	8.5 cm (3 1/4"), Ø 2.0 mm
68-263-30	8.5 cm (3 1/4"), Ø 3.0 mm





Ear Forceps, Ear Polypus Forceps, Micro Ear Forceps
Ohrpinzetten, Ohrpolypenzangen, Mikro-Ohrzängchen
Pinzas auriculares, Pinzas para pólipos auriculares, Micro pinzas auriculares
Pincés auriculaires, Pincés pour polypes auriculaires, Micro Pince auriculaires
Pinze auricolari, Pinze per polipi auricolari, Micro Pinze auricolari

Struempel Alligator Forcep

Catalog # Size
68-265-08 8.5 cm (3 1/4")



Hartmann-Weingartner Alligator Forcep

Catalog # Size
68-267-08 8.5 cm (3 1/4")



Hartmann-Hoffmar Alligator Punch Forcep

Catalog # Size
68-271-08 8.5 cm (3 1/4")



McGee Micro Alligator Forcep
Smooth, Straight

Catalog # Size, Jaw Size
68-281-08 8 cm (3"), 4.0 x 0.8 mm



McGee Micro Alligator Forcep
Serrated, Straight

Catalog # Size, Jaw Size
68-283-08 8 cm (3"), 4.0 x 0.8 mm



Micro Ear Forceps
Mikro-Ohrzängchen
Micro pinzas auriculares
Micro Pince auriculaires
Micro Pinze auricolari

McGee Micro Alligator Forcep
Serrated, Bent Upwards



Catalog #	Size, Jaw Size
68-285-08	8 cm (3"), 4.0 x 0.8 mm

McGee Micro Alligator Forcep
Serrated, Right



Catalog #	Size, Jaw Size
68-287-08	8 cm (3"), 4.0 x 0.8 mm

McGee Micro Alligator Forcep
Serrated, Left



Catalog #	Size, Jaw Size
68-289-08	8 cm (3"), 4.0 x 0.8 mm

Mini-McGee Micro Alligator Forcep
Smooth, Straight



Catalog #	Size, Jaw Size
68-291-08	8 cm (3"), 3.5 x 0.6 mm

Mini-McGee Micro Alligator Forcep
Serrated, Straight



Catalog #	Size, Jaw Size
68-293-08	8 cm (3"), 3.5 x 0.6 mm





Micro Ear Forceps
Mikro-Ohrzängchen
Micro pinzas auriculares
Micro Pince auriculaires
Micro Pinze auricolari

Micro Alligator Forcep
Smooth, Straight



Catalog #	Size, Jaw Size
68-301-08	8 cm (3"), 4.0 x 0.6 mm

Micro Alligator Forcep
Serrated, Straight



Catalog #	Size, Jaw Size
68-303-08	8 cm (3"), 4.0 x 0.6 mm

Micro Alligator Forcep
Serrated, Bent Upwards



Catalog #	Size, Jaw Size
68-305-08	8 cm (3"), 4.0 x 0.6 mm

Micro Alligator Forcep
Serrated, Right



Catalog #	Size, Jaw Size
68-307-08	8 cm (3"), 4.0 x 0.6 mm

Micro Alligator Forcep
Serrated, Left



Catalog #	Size, Jaw Size
68-309-08	8 cm (3"), 4.0 x 0.6 mm

Micro Ear Forceps
Mikro-Ohrzängchen
Micro pinzas auriculares
Micro Pince auriculaires
Micro Pinze auricolari

Micro Alligator Forcep
Straights, Cup Shaped

Catalog #	Size, Cup Size, Jaw Size
68-311-08	8 cm (3"), 1.0 x 0.9 mm, 4.0 mm



Micro Alligator Forcep
Bent Upwards, Cup Shaped

Catalog #	Size, Cup Size, Jaw Size
68-313-08	8 cm (3"), 1.0 x 0.9 mm, 4.0 mm



Micro Alligator Forcep
Right, Cup Shaped

Catalog #	Size, Cup Size, Jaw Size
68-315-08	8 cm (3"), 1.0 x 0.9 mm, 4.0 mm



Micro Alligator Forcep
Left, Cup Shaped

Catalog #	Size, Cup Size, Jaw Size
68-317-08	8 cm (3"), 1.0 x 0.9 mm, 4.0 mm



Micro Alligator Forcep
Straight, Cup Shaped

Catalog #	Size, Cup Size, Jaw Size
68-321-08	8 cm (3"), 0.6 x 0.5 mm, 3.5 mm





Micro Ear Forceps
Mikro-Ohrzängchen
Micro pinzas auriculares
Micro Pince auriculaires
Micro Pinze auricolari

Micro Alligator Forcep
Bent Upwards, Cup Shaped

Catalog #	Size, Cup Size, Jaw Size
68-323-08	8 cm (3"), 0.6 x 0.5 mm, 3.5 mm



Micro Alligator Forcep
Right, Cup Shaped

Catalog #	Size, Cup Size, Jaw Size
68-325-08	8 cm (3"), 0.6 x 0.5 mm, 3.5 mm



Micro Alligator Forcep
Left, Cup Shaped

Catalog #	Size, Cup Size, Jaw Size
68-327-08	8 cm (3"), 0.6 x 0.5 mm, 3.5 mm



Bellucci Micro Scissor
Straight, Very Fine

Catalog #	Size, Blade Size
68-331-08	8 cm (3"), 4.0 x 0.8 mm



Bellucci Micro Scissor
Bent Upwards, Very Fine

Catalog #	Size, Blade Size
68-333-08	8 cm (3"), 4.0 x 0.8 mm



Micro Ear Scissors
Mikro-Ohrscherchen
Micro tijeras auriculares
Micro Ciseaux auriculaires
Micro Forbici auricolari

Bellucci Micro Scissor
Right, Very Fine

Catalog #	Size, Blade Size
68-335-08	8 cm (3"), 4.0 x 0.8 mm



Bellucci Micro Scissor
Left, Very Fine

Catalog #	Size, Blade Size
68-337-08	8 cm (3"), 4.0 x 0.8 mm



Wullstein Micro Scissor
Straight

Catalog #	Size, Blade Size
68-341-08	8 cm (3"), 4.0 x 1.8 mm



Wullstein Micro Scissor
Bent Upwards

Catalog #	Size, Blade Size
68-343-08	8 cm (3"), 4.0 x 1.8 mm



Wullstein Micro Scissor
Right

Catalog #	Size, Blade Size
68-345-08	8 cm (3"), 4.0 x 1.8 mm



INCHES
MILLIMETERS



Micro Ear Scissors
Mikro-Ohrscherchen
Micro tijeras auriculares
Micro Ciseaux auriculaires
Micro Forbici auricolari

Wullstein Micro Scissor
Left



Catalog #	Size, Blade Size
68-347-08	8 cm (3"), 4.0 x 1.8 mm

Shea Micro Scissor
Straight



Catalog #	Size, Blade Size
68-351-08	8 cm (3"), 7.0 x 1.8 mm

Shea Micro Scissor
Right



Catalog #	Size, Blade Size
68-355-08	8 cm (3"), 7.0 x 1.8 mm

Shea Micro Scissor
Left



Catalog #	Size, Blade Size
68-357-08	8 cm (3"), 7.0 x 1.8 mm

McGee Wire Bending Forcep
Bent Downwards



Catalog #	Size, Jaw Size
68-361-01	8 cm (3"), 3.5 x 0.8 mm
68-361-02	8 cm (3"), 3.5 x 0.8 mm

Micro Ear Forceps, Micro Ear Knives
 Mikro-Ohrzängchen, Mikro-Ohrmesser
 Micro pinzas auriculares, Micro cuchillos auriculares
 Micro Pince auriculaires, Micro Couteaux auriculaires
 Micro Pinze auricolari, Micro Coltelli

House-Dieter Malleus Nipper

Catalog #	Size, Jaw Opening, Profile
68-365-01	8 cm (3"), 1.3 mm, Up Cutting
68-365-02	8 cm (3"), 1.3 mm, Down Cutting



House-Dieter Malleus Nipper

Catalog #	Size, Jaw Opening, Profile
68-365-03	8 cm (3"), 1.3 mm, Right Cutting
68-365-04	8 cm (3"), 1.3 mm, Left Cutting



**Fuller Introducing Forcep
 For Teflon Prosthesis**

Catalog #	Size
68-367-08	8 cm (3")



Schuknecht Rotary Knife

Catalog #	Size
68-401-01	15 cm (6")
68-401-02	15 cm (6")



Schuknecht Sickle Knife

Catalog #	Size
68-403-15	14.5 cm (5 3/4")





Wullstein Sickle Knife



Catalog # Size
68-405-15 15.5 cm (6")

Tabb Mucosa Knife



Catalog # Size
68-407-15 15.5 cm (6")

Plester Flap Knife



Catalog # Size
68-409-15 15 cm (6")

Plester Sickle Knife



Catalog # Size
68-415-15 15 cm (6")

Sexton Myringotomy Knife



Catalog # Size
68-417-15 15 cm (6")

Micro Ear Knives, Micro Ear Hooks
 Mikro-Ohrmesser, Mikro-Ohrhäkchen
 Micro cuchillos auriculares, Micro ganchitos auriculares
 Micro Couteaux auriculaires, Micro Crochets auriculaires
 Micro Coltelli, Micro Uncini auricolari

Rosen Circular Cut Knife



Catalog #	Size, Diameter, Profile
68-421-01	15 cm (6"), Ø 3.0 mm, Fig. 1
68-421-02	15 cm (6"), Ø 2.8 mm, Fig. 2
68-421-03	15 cm (6"), Ø 2.6 mm, Fig. 3
68-421-04	15 cm (6"), Ø 2.0 mm, Fig. 4
68-421-05	15 cm (6"), Ø 1.6 mm, Fig. 5
68-421-06	15 cm (6"), Ø 1.4 mm, Fig. 6
68-421-07	15 cm (6"), Ø 1.0 mm, Fig. 7



Barbara Micro Ear Pick



Catalog #	Size
68-450-16	16 cm (6 1/4")

**Barbara Micro Ear Pick
Angled**



Catalog #	Size
68-451-16	16 cm (6 1/4")

Barbara Micro Ear Pick



Catalog #	Size
68-453-16	16 cm (6 1/4")

Rosen Micro Ear Pick



Catalog #	Size
68-455-16	16 cm (6 1/4")





Micro Ear Hooks, Micro Ear Needles
Mikro-Ohrhäkchen, Mikro-Ohrnadeln
Micro ganchitos auriculares, Micro agujas auriculares
Micro Crochets auriculaires, Micro Aiguilles auriculaires
Micro Uncini auricolari, Micro Aghi auricolari

Barbara Micro Ear Pick
Angled 25°



Catalog #	Size, Tip Size
68-459-03	16 cm (6 1/4"), 0.3 mm
68-459-06	16 cm (6 1/4"), 0.6 mm
68-459-10	16 cm (6 1/4"), 1.0 mm

Barbara Micro Ear Pick
Angled 45°



Catalog #	Size, Tip Size
68-461-03	16 cm (6 1/4"), 0.3 mm
68-461-06	16 cm (6 1/4"), 0.6 mm
68-461-10	16 cm (6 1/4"), 1.0 mm
68-461-12	16 cm (6 1/4"), 1.2 mm
68-461-15	16 cm (6 1/4"), 1.5 mm
68-461-20	16 cm (6 1/4"), 2.0 mm
68-461-25	16 cm (6 1/4"), 2.5 mm

Barbara Micro Ear Pick
Angled 90°



Catalog #	Size, Tip Size
68-463-03	16 cm (6 1/4"), 0.3 mm
68-463-06	16 cm (6 1/4"), 0.6 mm
68-463-10	16 cm (6 1/4"), 1.0 mm
68-463-12	16 cm (6 1/4"), 1.2 mm
68-463-15	16 cm (6 1/4"), 1.5 mm
68-463-20	16 cm (6 1/4"), 2.0 mm
68-463-25	16 cm (6 1/4"), 2.5 mm



Micro Ear Hooks, Micro Ear Needles
 Mikro-Ohrhäkchen, Mikro-Ohrnadeln
 Micro ganchitos auriculares, Micro agujas auriculares
 Micro Crochets auriculaires, Micro Aiguilles auriculaires
 Micro Uncini auricolari, Micro Aghi auricolari

Barbara Micro Ear Needle
 Curved Down



Catalog #	Size, Tip Size
68-465-05	16 cm (6 1/4"), 0.5 mm
68-465-10	16 cm (6 1/4"), 1.0 mm



Micro Ear Needle
 Angled 90°



Catalog #	Size, Tip Size
68-467-03	15.5 cm (6"), 0.3 mm
68-467-06	15.5 cm (6"), 0.6 mm
68-467-10	15.5 cm (6"), 1.0 mm



Micro Ear Needle
 Angled 90°



Catalog #	Size, Tip Size
68-469-03	15.5 cm (6"), 0.3 mm
68-469-06	15.5 cm (6"), 0.6 mm
68-469-10	15.5 cm (6"), 1.0 mm



McGee Micro Ear Needle
 For Footplate



Catalog #	Size, Tip Size
68-473-05	15.5 cm (6"), 0.5 mm
68-473-10	15.5 cm (6"), 1.0 mm

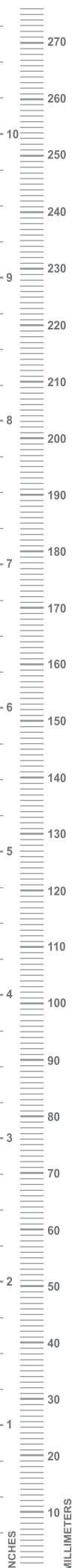



Micro Ear Hooks, Micro Ear Needles
Mikro-Ohrhäkchen, Mikro-Ohrnadeln
Micro ganchitos auriculares, Micro agujas auriculares
Micro Crochets auriculaires, Micro Aiguilles auriculaires
Micro Uncini auricolari, Micro Aghi auricolari

McGee Micro Ear Needle
For Footplate

Catalog #	Size, Tip Size
68-475-05	15.5 cm (6"), 0.5 mm
68-475-10	15.5 cm (6"), 1.0 mm



Barbara Micro Ear Needle

Catalog #	Size
68-478-16	15.5 cm (6")



Barbara Micro Ear Pick

Catalog #	Size
68-479-16	15.5 cm (6")



Micro Ear Pick
Angled 25°

Catalog #	Size, Tip Size
68-481-03	15.5 cm (6"), 0.3 mm
68-481-06	15.5 cm (6"), 0.6 mm
68-481-10	15.5 cm (6"), 1.0 mm



Micro Ear Pick
Angled 25°

Catalog #	Size, Tip Size
68-483-03	15.5 cm (6"), 0.3 mm
68-483-06	15.5 cm (6"), 0.6 mm
68-483-10	15.5 cm (6"), 1.0 mm





Micro Ear Hooks, Micro Ear Needles
 Mikro-Ohrhäkchen, Mikro-Ohrnadeln
 Micro ganchitos auriculares, Micro agujas auriculares
 Micro Crochets auriculaires, Micro Aiguilles auriculaires
 Micro Uncini auricolari, Micro Aghi auricolari

Micro Ear Pick
Angled 45°

Catalog #	Size, Tip Size
68-485-03	15.5 cm (6"), 0.3 mm
68-485-06	15.5 cm (6"), 0.6 mm
68-485-10	15.5 cm (6"), 1.0 mm



Micro Ear Pick
Angled 45°

Catalog #	Size, Tip Size
68-487-03	15.5 cm (6"), 0.3 mm
68-487-06	15.5 cm (6"), 0.6 mm
68-487-10	15.5 cm (6"), 1.0 mm



Micro Ear Needle
Angled 25°

Catalog #	Size, Tip Size
68-491-03	15.5 cm (6"), 0.3 mm
68-491-06	15.5 cm (6"), 0.6 mm



68-491-03

68-491-06

Shambaugh Micro Ear Needle
Angled 25°

Catalog #	Size, Tip Size
68-491-10	15.5 cm (6"), 1.0 mm





Micro Ear Hooks, Micro Dissectors
Mikro-Ohrhäkchen, Mikro-Dissektoren
Micro ganchitos auriculares, Micro disecadores
Micro Crochets auriculaires, Micro Dissecteurs
Micro Uncini auricolari, Micro Dissettori

Micro Ear Needle
Angled 45°



Catalog #	Size, Tip Size
68-493-03	15.5 cm (6"), 0.3 mm
68-493-06	15.5 cm (6"), 0.6 mm



Shambaugh Micro Ear Needle
Angled 45°



Catalog #	Size, Tip Size
68-493-10	15.5 cm (6"), 1.0 mm



Shea Exploring Hook
Angled 45°, Blunt



Catalog #	Size, Tip Size
68-497-20	15.5 cm (6"), 2.0 mm



Austin Attic Dissector
Angled 90°, Blunt



Catalog #	Size, Tip Size
68-501-30	15.5 cm (6"), 3.0 mm



Fisch Micro Dissector



Catalog #	Size, Profile
68-505-01	15.5 cm (6"), Angled to Right
68-505-02	15.5 cm (6"), Angled to Left
68-505-03	15.5 cm (6"), Angled to Right
68-505-04	15.5 cm (6"), Angled to Left

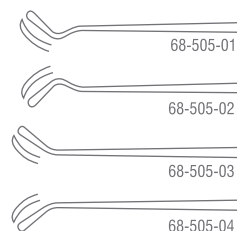



Micro Curettes, Micro Dissectors, Micro Measuring Rods
 Mikro-Küretten, Mikro-Dissektoren, Mikro-Messsonden
 Micro cucharillas, Micro disecadores, Micro Sondas para medir
 Micro Curettes, Micro Dissecteurs, Micro Sondes pour mesurer
 Micro cucchiari, Micro Dissettori, Micro Sonde per misurare

Rosen Micro Ear Periosteal Elevator



Catalog #	Size
68-509-01	15.5 cm (6")
68-509-02	15.5 cm (6")
68-509-03	15.5 cm (6")

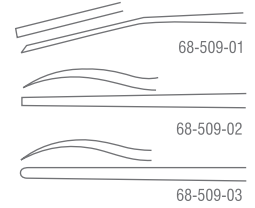

Rosen Micro Curette



Catalog #	Size
68-509-04	15.5 cm (6")

Rosen Micro Dissector



Catalog #	Size
68-509-05	15.5 cm (6")
68-509-06	15.5 cm (6")

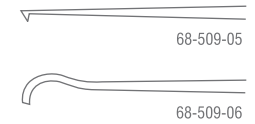

House Micro Measuring Rod



Catalog #	Size, Tip Size
68-511-01	15.5 cm (6"), 3.5 mm
68-511-02	15.5 cm (6"), 4.0 mm
68-511-03	15.5 cm (6"), 4.5 mm
68-511-04	15.5 cm (6"), 5.0 mm

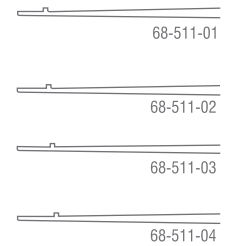



Micro Curettes
Mikro-Küretten
Micro cucharillas
Micro Curettes
Micro cucchiari

Buckingham Chisel

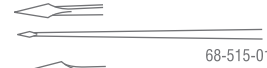

68-515-01

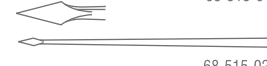

68-515-02



68-515-04

Catalog #	Size, Tip Size
68-515-01	18 cm (7"), 0.5 mm
68-515-02	18 cm (7"), 1.0 mm
68-515-04	18 cm (7"), 1.5 mm

Dingmann Otoprader

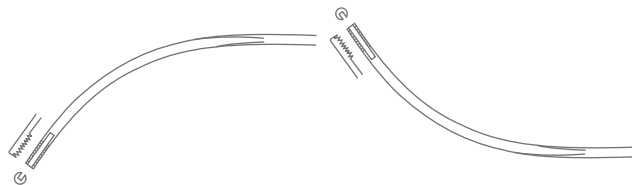

Catalog #	Profile
68-517-01	Left
68-517-02	Right



House Micro Ear Curette



68-515-01



68-515-02



68-515-04

Catalog #	Size, Cup Size 1, Cup Size 2
68-520-01	14.5 cm (5 3/4"), 1.0 mm, 1.2 mm
68-520-02	14.5 cm (5 3/4"), 1.5 mm, 1.8 mm
68-520-03	14.5 cm (5 3/4"), 1.0 mm, 1.2 mm
68-520-04	14.5 cm (5 3/4"), 1.5 mm, 1.8 mm

Shea Micro Ear Curette



Catalog #	Size
68-525-14	14.5 cm (5 3/4")

Micro Dissectors
Mikro-Dissektoren
Micro disecadores
Micro Dissecteurs
Micro Dissettori

Zoellner Micro Ear Needle
Straight



Catalog #	Size
68-535-01	13.5 cm (5 1/2")

Zoellner Micro Ear Needle
Angled 45° Upwards

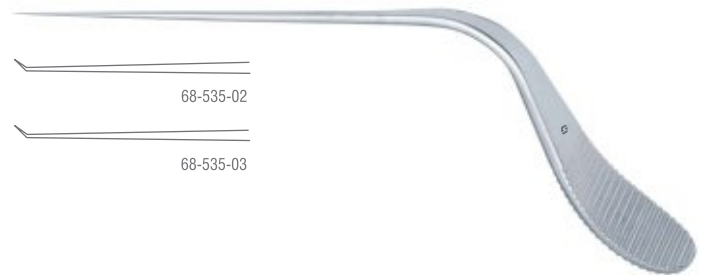

Catalog #	Size, Tip Size
68-535-02	13.5 cm (5 1/2"), 0.5 mm
68-535-03	13.5 cm (5 1/2"), 1.0 mm

Zoellner Micro Ear Needle
Angled 45° Downwards

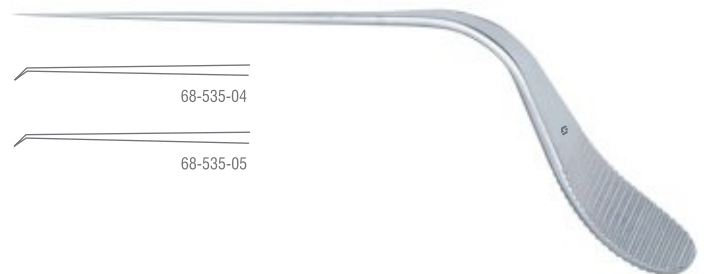

Catalog #	Size, Tip Size
68-535-04	13.5 cm (5 1/2"), 0.5 mm
68-535-05	13.5 cm (5 1/2"), 1.0 mm

Zoellner Micro Ear Needle
Angled 90° Upwards



Catalog #	Size, Tip Size
68-535-06	13.5 cm (5 1/2"), 0.5 mm

Zoellner Micro Ear Needle
Angled 90° Downwards



Catalog #	Size, Tip Size
68-535-07	13.5 cm (5 1/2"), 0.5 mm





Micro Dissectors
Mikro-Dissektoren
Micro disecadores
Micro Dissecteurs
Micro Dissettori

Zoellner Micro Ear Needle
For Footplate

Catalog #	Size, Tip Size
68-535-08	13.5 cm (5 1/2"), 1.0 mm
68-535-09	13.5 cm (5 1/2"), 1.0 mm



Zoellner Ear Knife
Angled 90° Upwards

Catalog #	Size
68-535-10	13.5 cm (5 1/2")



Zoellner Ear Knife
Angled 90° Downwards

Catalog #	Size
68-535-11	13.5 cm (5 1/2")



Zoellner Micro Ear Knife
Angled Upwards

Catalog #	Size
68-535-12	13.5 cm (5 1/2")



Zoellner Micro Ear Knife
Angled Downwards

Catalog #	Size
68-535-13	13.5 cm (5 1/2")



Micro Dissectors
Mikro-Dissektoren
Micro disecadores
Micro Dissecteurs
Micro Dissettori

Zoellner Tympanum Needle
Angled Upwards



Catalog #	Size
68-535-14	13.5 cm (5 1/2")

Zoellner Tympanum Needle
Angled Downwards



Catalog #	Size
68-535-15	13.5 cm (5 1/2")

Zoellner Raspatory



Catalog #	Size
68-535-16	13.5 cm (5 1/2")
68-535-17	13.5 cm (5 1/2")

Zoellner Application Instrument



Catalog #	Size
68-535-18	Standard





Ear Cures
Ohrküretten
Curetas auriculares
Curettes auriculaires
Curette auricolari

Langenbeck Ear Curette
Blunt



Catalog #	Size
68-551-13	13 cm (5")

Shapleigh Ear Curette



Catalog #	Size, Profile
68-555-01	15 cm (6"), Fig. 1
68-555-02	15 cm (6"), Fig. 2



Buck Ear Curette
Straight, Blunt



Catalog #	Size, Profile
68-570-01	17 cm (6 3/4"), Fig. 000
68-570-02	17 cm (6 3/4"), Fig. 00
68-570-10	17 cm (6 3/4"), Fig. 0
68-570-11	17 cm (6 3/4"), Fig. 1
68-570-12	17 cm (6 3/4"), Fig. 2
68-570-13	17 cm (6 3/4"), Fig. 3
68-570-14	17 cm (6 3/4"), Fig. 4





Ear Cures
Ohrküretten
Curetas auriculares
Curettes auriculaires
Curette auricolari

Buck Ear Curette
Angled, Blunt



Catalog #	Size, Profile
68-571-01	17 cm (6 3/4"), Fig. 000
68-571-02	17 cm (6 3/4"), Fig. 00
68-571-10	17 cm (6 3/4"), Fig. 0
68-571-11	17 cm (6 3/4"), Fig. 1
68-571-12	17 cm (6 3/4"), Fig. 2
68-571-13	17 cm (6 3/4"), Fig. 3
68-571-14	17 cm (6 3/4"), Fig. 4

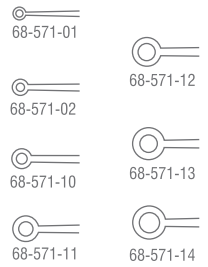

Buck Ear Curette
Straight, Sharp



Catalog #	Size, Profile
68-572-01	17 cm (6 3/4"), Fig. 000
68-572-02	17 cm (6 3/4"), Fig. 00
68-572-10	17 cm (6 3/4"), Fig. 0
68-572-11	17 cm (6 3/4"), Fig. 1
68-572-12	17 cm (6 3/4"), Fig. 2
68-572-13	17 cm (6 3/4"), Fig. 3
68-572-14	17 cm (6 3/4"), Fig. 4

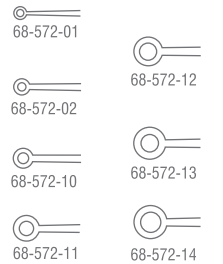

Buck Ear Curette
Angled, Sharp



Catalog #	Size, Profile
68-573-01	17 cm (6 3/4"), Fig. 000
68-573-02	17 cm (6 3/4"), Fig. 00
68-573-10	17 cm (6 3/4"), Fig. 0
68-573-11	17 cm (6 3/4"), Fig. 1
68-573-12	17 cm (6 3/4"), Fig. 2
68-573-13	17 cm (6 3/4"), Fig. 3
68-573s-14	17 cm (6 3/4"), Fig. 4

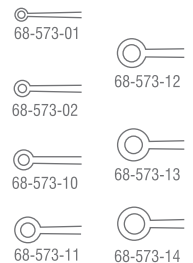



Jansen Ear Scoop
Sharp



Catalog # Size
68-576-15 17 cm (6 3/4")

Barth Ear Scoop
Sharp



Catalog # Size
68-580-18 18 cm (7")

Gross Ear Scoop-Hook
Blunt



Catalog # Size
68-583-13 13 cm (5")

Lempert Ear Scoop
Sharp



Catalog #	Size, Profile
68-600-10	21.5 cm (8 1/2"), Fig. 0
68-600-20	21.5 cm (8 1/2"), Fig. 00
68-600-30	21.5 cm (8 1/2"), Fig. 000
68-600-40	21.5 cm (8 1/2"), Fig. 0000
68-600-50	21.5 cm (8 1/2"), Fig. 00000



Foreign Body Instruments
Fremdkörperinstrumente
Instrumentos para cuerpos extraños
Instruments pour corps étrangers
Strumenti per corpi estranei

FiberGrip™ Lempert Ear Scoop
Sharp



Catalog #	Size, Profile
68-610-10	21.5 cm (8 1/2"), Fig. 0
68-610-20	21.5 cm (8 1/2"), Fig. 00
68-610-30	21.5 cm (8 1/2"), Fig. 000
68-610-40	21.5 cm (8 1/2"), Fig. 0000
68-610-50	21.5 cm (8 1/2"), Fig. 00000



Weber-Loch Ear Loop



Catalog #	Size
68-650-01	16.5 cm (6 1/4")

Billeau Ear Loop



Catalog #	Size
68-660-01	16 cm (6 1/4")
68-660-02	16 cm (6 1/4")
68-660-03	16 cm (6 1/4")

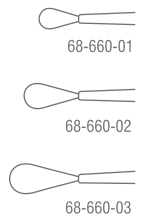

Hartmann Ear Hook
Sharp



Catalog #	Size
68-671-16	16 cm (6 1/4")





Ear Hooklet, Tympanum Needles
Ohrhäkchen, Trommelfellnadeln
Ganchito auricular, Agujas para tímpano
Levier pour corps étrangers, Instruments pour corps étrangers
Uncino auricolare, Strumenti per corpi estranei

Lucae Ear Hook



Catalog #	Size, Profile
68-673-01	14 cm (5 1/2"), Small
68-673-02	14 cm (5 1/2"), Medium
68-673-03	14 cm (5 1/2"), Large

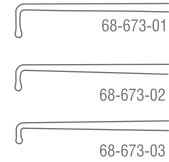

Wagener Ear Hook



Catalog #	Size, Point Size, Profile
68-675-01	14 cm (5 1/2"), 2 mm, Fig. 1
68-675-02	14 cm (5 1/2"), 2.5 mm, Fig. 2
68-675-03	14 cm (5 1/2"), 3 mm, Fig. 3
68-675-04	14 cm (5 1/2"), 3.5 mm, Fig. 4
68-675-05	14 cm (5 1/2"), 4 mm, Fig. 5

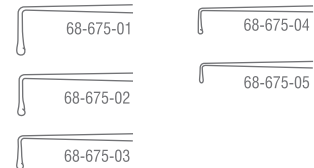

Day Ear Hook



Catalog #	Size, Profile
68-677-01	17 cm (6 3/4"), Long
68-677-02	17 cm (6 3/4"), Short



Seeker

With Ball Probe, Angled 45°



Catalog #	Size
68-679-01	15.5 cm (6")



Tympanum Needles
Trommelfellnadeln
Agujas para timpano
Instruments pour corps étrangers
Strumenti per corpi estranei

Politzer Furuncle Knife



Catalog #	Size
68-701-16	14.5 cm (5 3/4")

Politzer Tympanum Needle



Catalog #	Size
68-704-16	17.5 cm (7")

Politzer Tympanum Needle



Catalog #	Size
68-707-16	15.5 cm (6")

**Politzer Tympanum Needle
Needle Horizontal**



Catalog #	Size
68-709-16	16 cm (6 1/4")

Lucae Tympanum Needle



Catalog #	Size
68-711-16	17.5 cm (7")

INCHES
MILLIMETERS



Lucae Tympanum Needle



Catalog #	Size
68-713-16	17.5 cm (7")

Moldnebauer Foreign Body Lever



Catalog #	Size
68-721-16	15.5 cm (6")

Zaufal Foreign Body Lever



Catalog #	Size
68-723-16	15 cm (6")

Lempert Periosteal Elevator



Catalog #	Size, Width
68-727-20	20.5 cm (8"), 6 mm

Lempert Periosteal Elevator



Catalog #	Size, Width
68-729-18	18 cm (7"), 6 mm

Mastoid Rongeurs, Ear Syringes
Ohr-Knochenstanzen, Ohrspritzen
Pinzas cortantes para huesos, Jeringas auriculares
Ostéotomes emporte-pièces, Seringues auriculaires
Pinze osteotomi, Siringhe auricolari

Lempert Periosteal Elevator



Catalog #	Size, Width
68-731-02	17 cm (6 3/4"), 2 mm
68-731-03	17 cm (6 3/4"), 3 mm
68-731-04	17 cm (6 3/4"), 4 mm
68-731-05	17 cm (6 3/4"), 5 mm

Citelli Mastoid Rongeur



Catalog #	Size, Bite Size
68-751-02	17 cm (6 3/4"), 2 mm
68-751-03	17 cm (6 3/4"), 3 mm

Beyer Mastoid Rongeur



Catalog #	Size, Bite Size
68-755-19	19 cm (7 1/2"), 2 mm

Beyer Mastoid Rongeur



Catalog #	Size, Bite Size
68-759-14	14 cm (5 1/2"), 1 mm

Ear Syringe Complete

With Protection Disk and 2 Tips



Catalog #	Capacity
68-800-00	50 ml

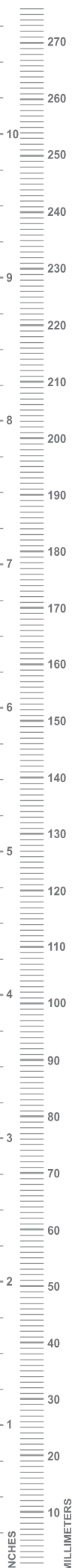



Ear Syringes
Ohrspritzen
Jeringas auriculares
Seringues auriculaires
Siringhe auricolari

Ear Syringe Complete
With Protection Disk and 2 Tips

Catalog #	Capacity
68-802-00	100 ml





RHINOLOGY INSTRUMENTS

SunMark Rhinology Instruments are meticulously designed and crafted to provide a cleaner and more precise cut, preserve mucosa, and minimize trauma to adjacent structures during sinus surgery.

SunMark range of rhinology instruments cover a broad spectrum and include the following nasal speculums, nasal polypus snares, nasal tampon forceps, nasal polypus forceps, septum forceps, ethmoid forceps, nasal cutting forceps, sphenoidal punches, rhinos plastic knives, septum knives, septum elevators, periosteal elevators, septum chisels, septum osteotomes, septum gouges, nasal saws, cartilage crushers, bone files, nasal rasps, nasal hooks and retractors, septum straightening forceps, antrum curettes, adenoid curettes, adenotomes, irrigation cannulas and sinus dilators.

Rhinologie

Rinología

Rhinologie

Rinología

Nasal Specula
Nasenspekula
Espéculos nasales
Spéculums nasaux
Specoli nasali

Thudichum Nasal Specula

Set of 3 Ref: 74-012-01 to 74-012-03

Catalog #	Size
74-011-10	Standard



Thudichum Nasal Specula

Set of 4 Ref: 74-012-01 to 74-012-04

Catalog #	Size
74-011-20	Standard



Thudichum Nasal Specula

Set of 3 Ref: 74-012-05 to 74-012-07

Catalog #	Size
74-011-30	Standard



Thudichum Nasal Specula

Set of 7 Ref: 74-012-01 to 74-012-07

Catalog #	Size
74-011-40	Standard



Thudichum Nasal Speculum

Catalog #	Blade Size, Profile
74-013-01	12 mm , Fig. 1
74-013-02	14 mm , Fig. 2
74-013-03	16.5 mm , Fig. 3
74-013-04	18.5 mm , Fig. 4
74-013-05	20.5 mm , Fig. 5
74-013-06	22 mm , Fig. 6
74-013-07	23 mm , Fig. 7

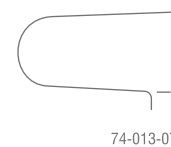
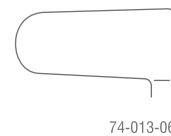
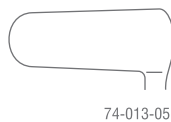



Voltolini Nasal Speculum

Catalog #	Profile
74-017-01	Fig. 1
74-017-02	Fig. 2
74-017-03	Fig. 3



Mod. Vienna Nasal Specula

Set of 3 Ref: 74-023-01 to 74-023-03

Catalog #	Size
74-021-10	Standard



Mod. Vienna Nasal Speculum

Catalog #	Blade Length, Profile
74-023-01	27 mm, Fig. 1
74-023-02	31 mm, Fig. 2
74-023-03	35 mm, Fig. 3



Hartmann-Halle Nasal Specula

Set of 3 Ref: 74-033-01 to 74-033-03

Catalog #	Size
74-031-10	Standard



Nasal Specula
Nasenspekula
Espéculos nasales
Spéculum nasaux
Specoli nasali

Hartmann-Halle Nasal Speculum

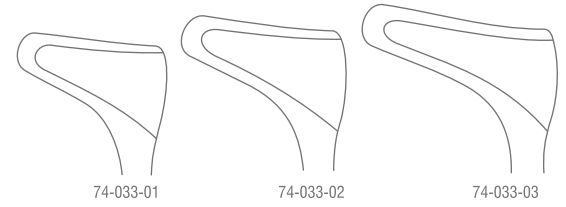

Catalog #	Size, Blade Length, Profile
74-033-01	15.5 cm (6"), 27 mm, Fig. 1
74-033-02	15.5 cm (6"), 31 mm, Fig. 2
74-033-03	15.5 cm (6"), 35 mm, Fig. 3



Martin Nasal Specula



Catalog #	Size, Blade Length
74-035-13	13 cm (5"), 17 mm



**Martin Nasal Specula
Bent Sidewards**



Catalog #	Size, Blade Length
74-037-13	12.5 cm (5"), 17 mm



Tieck-Halle Nasal Specula



Catalog #	Size, Blade Length
74-041-13	13 cm (5"), 16 mm



Killian Nasal Specula

Set of 4 Ref; 74-053-01 to 74-053-04

Catalog #	Size
74-051-10	Standard





Killian Nasal Speculum

Catalog #	Size, Blade Length, Profile
74-053-01	13 cm (5"), 35 mm, Fig. 1
74-053-02	13 cm (5"), 50 mm, Fig. 2
74-053-03	13 cm (5"), 75 mm, Fig. 3
74-053-04	13 cm (5"), 85 mm, Fig. 4

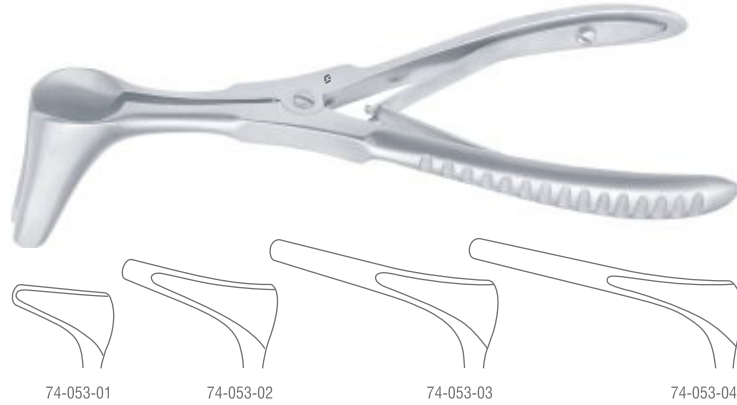

Cottle Nasal Specula

Set of 4 Ref; 74-063-01 to 74-063-04

Catalog #	Size
74-061-10	Standard



Cottle Nasal Speculum

Catalog #	Size, Blade Length, Profile
74-063-01	13.5 cm (5 1/4"), 35 mm, Fig. 1
74-063-02	13.5 cm (5 1/4"), 50 mm, Fig. 2
74-063-03	13.5 cm (5 1/4"), 75 mm, Fig. 3
74-063-04	14.5 cm (5 3/4"), 85 mm, Fig. 4

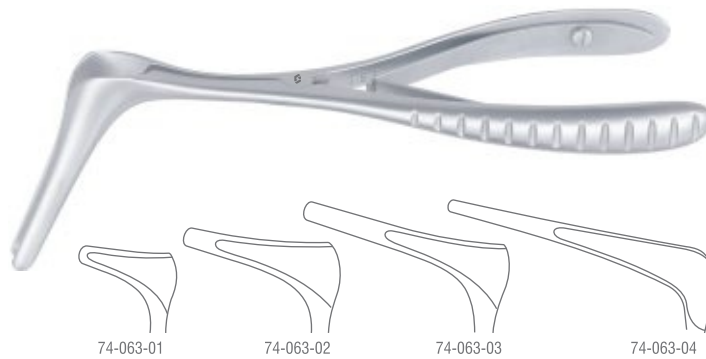

Cottle Nasal Specula

Set of 4 Ref; 74-067-01 to 74-067-04

Catalog #	Size
74-065-10	Standard



Nasal Specula, Polypus Snares
Nasenspekula, Polypenschnürer
Espéculos nasales, Polipótomos
Spéculum nasaux, Serre-noeuds pour polypes
Specoli nasali, Serranodi per polipi

Cottle Nasal Speculum
With Screw Fixation



Catalog #	Size, Blade Length, Profile
74-067-01	13.5 cm (5 1/4"), 35 mm, Fig. 1
74-067-02	13.5 cm (5 1/4"), 50 mm, Fig. 2
74-067-03	13.5 cm (5 1/4"), 75 mm, Fig. 3
74-067-04	14.5 cm (5 3/4"), 85 mm, Fig. 4

Cottle Nasal Specula
Black



Catalog #	Size, Blade Length
74-073-45	13.5 cm (5 1/4"), 45 mm
74-073-75	14 cm (5 1/2"), 75 mm

Krause Polypus Snare



Catalog #	Size, Shaft Diameter
74-091-26	26 cm (10 1/4"), Ø 3.0 mm

Krause-Voss Polypus Snare



Catalog #	Size, Shaft Diameter
74-093-26	26 cm (10 1/4"), Ø 3.0 mm

Lange-Wilde Polypus Snare



Catalog #	Size
74-095-24	24 cm (9 1/2")





Nasal Tampon Forceps
Nasentamponpinzetten
Pinzas para taponamiento
Pincès à pansements
Pinze per medicature

Polypus Wire

Bundle with 12 Pieces



Catalog #	Size, Diameter
74-097-12	10.5 cm (4"), Ø 0.3

Troeltsch Nasal Tampon Forcep



Catalog #	Size
74-101-15	14.5 cm (5 3/4")

Troeltsch Nasal Tampon Forcep



Catalog #	Size
74-103-18	18 cm (7")

Gruenwald (Jansen) Nasal Tampon Forcep



Catalog #	Size
74-105-21	21.5 cm (8 1/2")

Nasal Tampon Forcep

Smooth Jaws



Catalog #	Size
74-107-16	16 cm (6 1/4")

Nasal Tampon Forceps
Nasentamponpinzetten
Pinzas para taponamiento
Pinces à pansements
Pinze per medicature

Nasal Tampon Forcep
1 x 2 Teeth

Catalog #	Size
74-109-16	16 cm (6 1/4")



Nasal Tampon Forcep
Smooth Jaws

Catalog #	Size
74-111-18	18.5 cm (7 1/4")



Nasal Tampon Forcep
1 x 2 Teeth

Catalog #	Size
74-113-20	20 cm (8")



Westmacott Nasal Polypus Forcep

Catalog #	Size
74-121-18	18.5 cm (7 1/4")

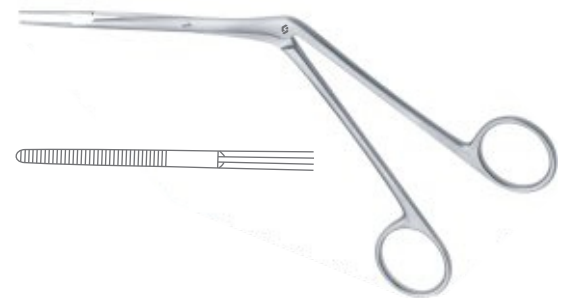

Lubet-Barbon Nasal Polypus Forcep

Catalog #	Size
74-123-20	20 cm (8")





Hartmann Nasal Polypus Forcep



Catalog #	Size
74-127-16	15 cm (6")

Heymann-Knight Nasal Polypus Forcep



Catalog #	Size
74-129-18	18 cm (7")

Hartmann Nasal Polypus Forcep



Catalog #	Size
74-131-20	18.5 cm (7 1/4")

Littauer Nasal Polypus Forcep



Catalog #	Size
74-133-18	18 cm (7")

Killian Nasal Polypus Forcep



Catalog #	Size
74-135-16	16 cm (6 1/4")

Septum Forceps, Ethmoid Bone Forceps
 Septumzangen, Siebbeinzangen
 Pinzas para tabique nasal, Pinzas para etmoides
 Pincas pour la cloison nasale, Pincas éthmoidales
 Pinze per il setto nasale, Pinze etmoidali

Heymann Septum Forcep



Catalog #	Size, Profile
74-161-01	18 cm (7"), Fig. 1
74-161-02	18 cm (7"), Fig. 2
74-161-03	18 cm (7"), Fig. 3

Knight Septum Forcep



Catalog #	Size
74-165-17	17 cm (6 3/4")

Craig Septum Forcep



Catalog #	Size
74-167-16	16 cm (6 1/4")

Craig-Dominick Ethmoid Forcep

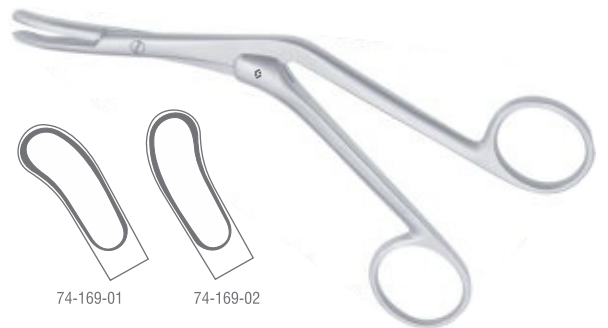

Catalog #	Size, Profile
74-169-01	16 cm (6 1/4"), Curved Left
74-169-02	16 cm (6 1/4"), Curved Right

Luc Ethmoid Forcep
Fenestrated



Catalog #	Size, Profile
74-171-01	20 cm (8"), Fig. 1
74-171-02	20 cm (8"), Fig. 2





Luc Ethmoid Forcep



Catalog #	Size, Profile
74-173-01	20 cm (8"), Fig. 1
74-173-02	20 cm (8"), Fig. 2

Bruenings Ethmoid Forcep



Catalog #	Size, Profile
74-175-01	16.5 cm (6 1/2"), Fig. 1
74-175-02	16.5 cm (6 1/2"), Fig. 2
74-175-03	16.5 cm (6 1/2"), Fig. 3
74-175-04	16.5 cm (6 1/2"), Fig. 4

**Takahashi Ethmoid Forcep
Straight**



Catalog #	Size
74-181-12	12 cm (4 3/4")

**Takahashi Ethmoid Forcep
Bent Upwards**



Catalog #	Size
74-183-12	12 cm (4 3/4")

Watson-Williams Ethmoid Forcep



Catalog #	Size
74-191-19	12 cm (4 3/4")

Nasal Cutting Forceps, Ethmoid Bone Forceps
Scharfe Nasenzangen, Siebbeinzangen
Pinzas nasales cortantes, Pinzas para etmoides
Pincas nasales coupantes, Pincas éthmoidales
Pinze taglianti per il naso, Pinze etmoidali

Watson-Williams Ethmoid Forcep



Catalog #	Size
74-193-19	12 cm (4 3/4")

**Weil Ethmoid Forcep
With Neck**

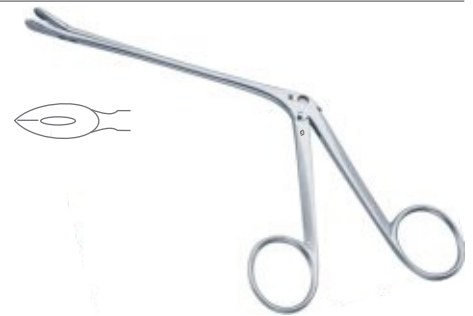

Catalog #	Size
74-195-19	12 cm (4 3/4")

**Weil-Blakesley Nasal Cutting Forcep
Straight**

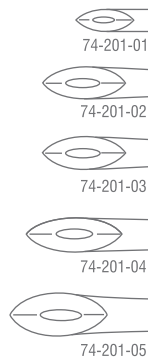

Catalog #	Size, Bite Size, Profile
74-201-01	12 cm (4 3/4"), 3.0 mm, Fig. 1
74-201-02	12 cm (4 3/4"), 3.5 mm, Fig. 2
74-201-03	12 cm (4 3/4"), 4.5 mm, Fig. 3
74-201-04	12 cm (4 3/4"), 5.0 mm, Fig. 4
74-201-05	12 cm (4 3/4"), 5.5 mm, Fig. 5

**Weil-Blakesley Nasal Cutting Forcep
Angled 45°**



Catalog #	Size, Bite Size, Profile
74-203-01	12 cm (4 3/4"), 3.0 mm, Fig. 1
74-203-02	12 cm (4 3/4"), 3.5 mm, Fig. 2
74-203-03	12 cm (4 3/4"), 4.5 mm, Fig. 3
74-203-04	12 cm (4 3/4"), 5.0 mm, Fig. 4

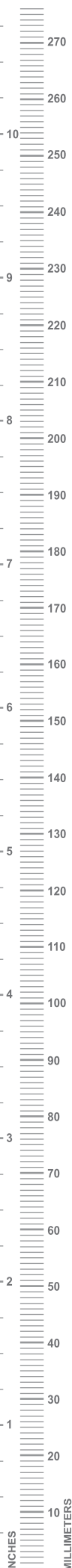



Nasal Cutting Forceps, Ethmoid Bone Forceps
Scharfe Nasenzangen, Siebbeinzangen
Pinzas nasales cortantes, Pinzas para etmoides
Pincas nasales coupantes, Pincas éthmoidales
Pinze taglianti per il naso, Pinze etmoidali

Weil-Blakesley Nasal Cutting Forcep
Angled 90°

Catalog #	Size, Bite Size, Profile
74-205-01	12 cm (4 3/4"), 3.0 mm, Fig. 1
74-205-02	12 cm (4 3/4"), 3.0 mm??, Fig. 2
74-205-03	12 cm (4 3/4"), 4.5 mm, Fig. 3
74-205-04	12 cm (4 3/4"), 5.0 mm, Fig. 4



Struycken Nasal Cutting Forcep

Catalog #	Size, Bite Size, Profile
74-231-01	12 cm (4 3/4"), 0.9 mm, Fig. 1
74-231-02	12 cm (4 3/4"), 1.2 mm, Fig. 2



Stamberger Nasal Cutting Forcep

Catalog #	Size, Bite Size, Profile
74-235-01	12 cm (4 3/4"), 2.0 mm, Retrograde Up Cutting
74-235-02	12 cm (4 3/4"), 2.0 mm, Retrograde Right Cutting
74-235-03	12 cm (4 3/4"), 2.0 mm, Retrograde Left Cutting



Hartmann Nasal Cutting Forcep (Conchotome)

Catalog #	Size, Diameter, Profile
74-241-01	12 cm (4 3/4"), Ø 5.0 mm, Fig. 1
74-241-02	12 cm (4 3/4"), Ø 7.0 mm, Fig. 2
74-241-03	12 cm (4 3/4"), Ø 9.0 mm, Fig. 3
74-241-04	12 cm (4 3/4"), Ø 11.0 mm, Fig. 4



Septum Forceps, Septum Morselizer
 Septumzangen, Septumquetschzange
 Pinzas para tabique nasal, Pinza para aplastamiento
 Pincas pour la cloison nasale, Pince-gouge pour la cloison nasale
 Pinze per il setto nasale, Pinza contundente per il setto nasale

Schmeden Nasal Cutting Forcep



Catalog #	Size, Diameter
74-245-12	12 cm (4 3/4"), Ø 8.0 mm

**Jansen-Middelton Septum Forcep
 Through Cutting Jaws**

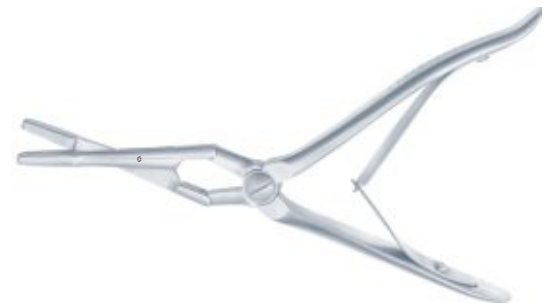

Catalog #	Size
74-281-19	19 cm (7 1/2")

**Jansen-Middelton Septum Forcep
 Curved Shaped Jaws**



Catalog #	Size
74-283-19	19 cm (7 1/2")

UltraGrip™ TC Rubin Septum Forcep

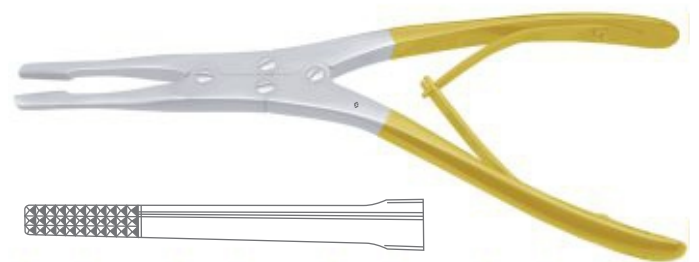

Catalog #	Size
74-291-21	21 cm (8 1/4")

UltraGrip™ TC Lower Lateral Morselizer



Catalog #	Size
74-293-21	19 cm (7 1/2")





Sphenoid Bone Punches
Keilbeinstanzen
Pinzas sacabocadas para esfenoides
Pinces emporte-pièces pour sinus sphénoïdal
Pinze taglianti per seno sfenoidale

Hajek Sphenoid Punch

Catalog #	Size, Bite Size, Profile
74-301-01	14 cm (5 1/2"), 4.0 mm x 4.0 mm, Up Cutting
74-301-02	14 cm (5 1/2"), 4.0 mm x 4.0 mm, Down Cutting

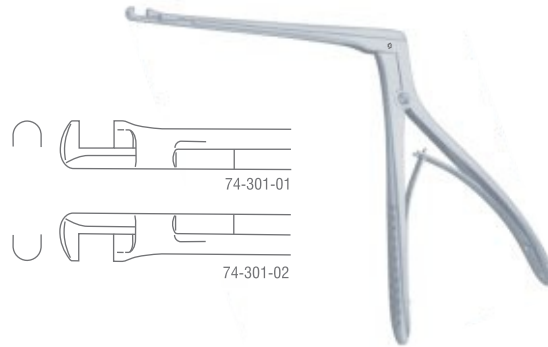

Hajek-Kofler Sphenoid Punch

Catalog #	Size, Bite Size, Profile
74-303-01	14 cm (5 1/2"), 3.5 mm x 3.5 mm, Up Cutting
74-303-02	14 cm (5 1/2"), 3.5 mm x 3.5 mm, Down Cutting

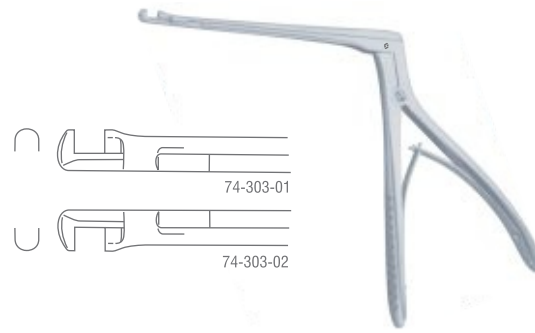

Kerrison Sphenoid Punch
Up Cutting

Catalog #	Size, Diameter
74-305-03	14 cm (5 1/2"), Ø 3.0 mm x 3.0 mm
74-305-04	9 cm (3 1/2"), Ø 4.0 mm x 4.0 mm
74-305-05	9 cm (3 1/2"), Ø 5.0 mm x 5.0 mm
74-305-06	9 cm (3 1/2"), Ø 6.0 mm x 6.0 mm



Joseph Rhinoplasty Knife
Straight, Fig. 1

Catalog #	Size
74-350-15	15 cm (6")

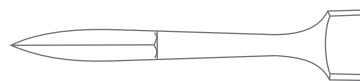

Joseph Rhinoplasty Knife
Curved, Fig. 2

Catalog #	Size
74-351-15	15 cm (6")

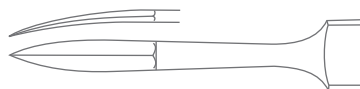



Rhinoplastic Knives
Rhinoplastik-Messer
Cuchillos rinoplásticos
Couteaux pour plastie du nez
Bisturi per plastica nasale

Fomon Rhinoplasty Knife

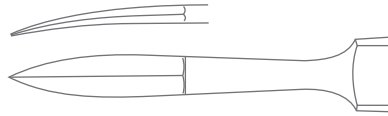

Catalog #	Size
74-355-15	16.5 cm (6 1/2")

Converse Rhinoplasty Knife



Catalog #	Size
74-361-16	16 cm (6 1/4")

Joseph Rhinoplasty Knife



Catalog #	Size
74-365-15	15 cm (6")

Cottle Rhinoplasty Knife



Catalog #	Size
74-367-15	14 cm (5 1/2")

Freer Mucosa Knife



Catalog #	Size
74-369-15	16.5 cm (6 1/2")

INCHES
MILLIMETERS



Septum Knives, Swivel Knives
Septummesser, Schwingmesser
Cuchillos para tabique nasal
Bistouris pour la cloison nasale
Bisturi per il setto nasale

Freer Septum Knife



Catalog #	Size, Profile
74-371-01	18 cm (7"), Right
74-371-02	18 cm (7"), Left

Freer Septum Knife



Catalog #	Size
74-373-01	18 cm (7")
74-373-02	19 cm (7 1/2")

Ballenger Swivel Knife
Straight



Catalog #	Size, Cutting Edge Size
74-380-03	21 cm (8 1/4"), 3.0 mm
74-380-04	21 cm (8 1/4"), 4.0 mm
74-380-05	21 cm (8 1/4"), 5.0 mm

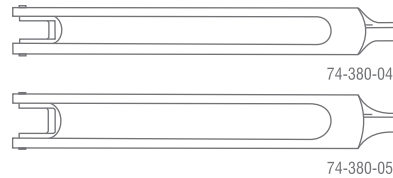

Ballenger Swivel Knife
Bayonet Shaped



Catalog #	Size, Cutting Edge Size
74-381-03	20 cm (8"), 3.0 mm
74-381-04	20 cm (8"), 4.0 mm
74-381-05	20 cm (8"), 5.0 mm

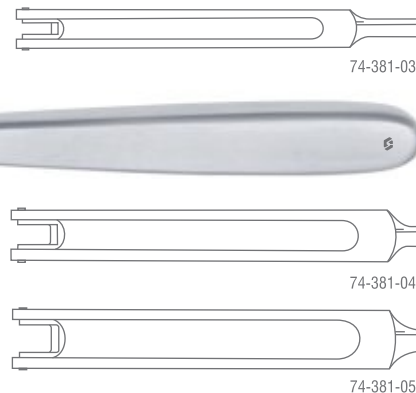

Septum Elevators
Septumelevatorien
Elevadores para tabique nasal
Elévateurs pour la cloison nasale
Elevatori per il setto nasale

McKenty Septum Elevator



Catalog #	Size, Blade Size
74-451-04	15 cm (6"), 4.0 mm
74-451-05	15 cm (6"), 5.0 mm



Halle Septum Elevator



Catalog #	Size, Blade Size
74-455-16	16 cm (6 1/4"), 3.5 mm



Joseph Septum Elevator



Catalog #	Size, Blade Size
74-461-16	16 cm (6 1/4"), 4.0 mm



Freer Septum Elevator



Catalog #	Size, Blade Size, Profile
74-471-19	19 cm (7 1/2"), 5.0 mm, Sharp
74-473-19	19 cm (7 1/2"), 6.0 mm, Blunt

Freer Septum Elevator
Double Ended, Sharp/Blunt



Catalog #	Size, Blade Size 1, Blade Size 2
74-475-18	18.5 cm (7 1/4"), 5.0 mm, 5.0 mm





Septum Elevators
Septumelevatorien
Elevadores para tabique nasal
Élévateurs pour la cloison nasale
Elevatori per il setto nasale

Freer Septum Elevator

Double Ended, Sharp/Blunt

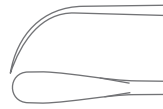

Catalog # Size, Blade Size 1, Blade Size 2
74-477-20 20.5 cm (8"), 6.0 mm, 5.0 mm

McKenty Septum Elevator



Catalog # Size, Blade Size 1, Blade Size 2
74-479-20 20.5 cm (8"), 4.0 mm, 4.0 mm

Ballenger-Hajek Septum Elevator



Catalog # Size, Blade Size 1, Blade Size 2
74-482-19 19 cm (7 1/2"), 6.0 mm, 6.0 mm

Cottle Septum Elevator

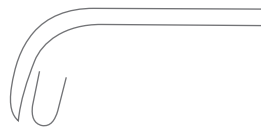

Catalog # Size, Blade Size 1, Blade Size 2
74-501-23 23.5 cm (9 1/4"), 5.0 mm, 5.0 mm

Killian Septum Elevator



Catalog # Size, Blade Size 1, Blade Size 2
74-503-18 18 cm (7"), 4.0 mm, 4.0 mm



Periosteal Elevators
 Periostelevatorien
 Legras para periostio
 Elévateurs pour le périoste
 Elevatori per il periosto

Killian Septum Elevator



Catalog # Size, Blade Size 1, Blade Size 2
 74-505-23 23 cm (9"), 4.5 mm , 4.5 mm

Pierce Septum Elevator

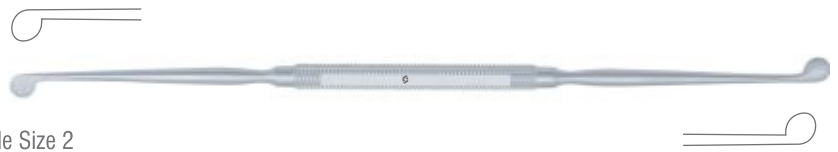

Catalog # Size, Blade Size 1, Blade Size 2
 74-507-21 21.5 cm (8 ½"), 4.0 mm , 4.0 mm

Pennington Septum Elevator



Catalog # Size, Blade Size 1, Blade Size 2
 74-509-21 21.5 cm (8 ½"), 4.0 mm , 4.0 mm

Roger Periosteal Elevator



Catalog # Size, Blade Size 1, Blade Size 2
 74-511-19 19.5 cm (7 ¾"), 4.0 mm , 4.0 mm

Cottle Periosteal Elevator



Catalog # Size, Blade Size 1, Blade Size 2
 74-541-22 23 cm (9"), 3.3 mm , 3.7 mm





Masing Periosteal Elevator



Catalog # Size, Blade Size 1, Blade Size 2
74-543-21 19.5 cm (7 3/4"), 3.0 mm , 2.0 mm

Cottle Periosteal Elevator

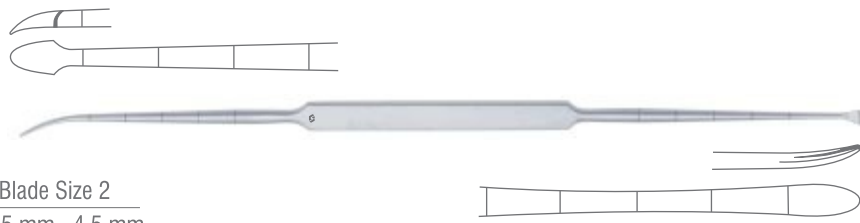

Catalog # Size, Blade Size 1, Blade Size 2
74-545-21 19.5 cm (7 3/4"), 4.5 mm , 4.5 mm

Howarth Periosteal Elevator



Catalog # Size
74-547-21 21.5 cm (8 1/2")

Joseph Periosteal Elevator



Catalog # Size, Blade Width
74-551-16 18 cm (7"), 6.0 mm

Freer Septum Chisel
Straight



Catalog # Size, Blade Width
74-600-16 16.5 cm (6 1/2"), 4.0 mm

Septum Chisels, Septum Gouges
 Septummeißel, Septum-Hohlmeißel
 Cinceles para tabique nasal, Gubias para tabique nasal
 Elévateurs pour le périoste, Gouges pour la cloison nasale
 Elevatori per il periosto, Sgorbie per il setto nasale

Freer Septum Chisel
Curved

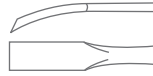

Catalog #	Size, Blade Width
74-601-16	16.5 cm (6 1/2"), 4.0 mm

West Septum Chisel



Catalog #	Size
74-604-16	16 cm (6 1/4")

West Septum Gouge



Catalog #	Size
74-605-16	16 cm (6 1/4")

Freer Septum Gouge

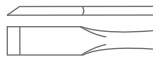

Catalog #	Size, Blade Width
74-608-16	15 cm (6"), 6.0 mm

Ballenger Septum Gouge



74-610-02



74-610-04



74-610-06



74-610-08

Catalog #	Size, Blade Width
74-610-02	15 cm (6"), 2.0 mm
74-610-04	15 cm (6"), 4.0 mm
74-610-06	15 cm (6"), 6.0 mm
74-610-08	15 cm (6"), 8.0 mm

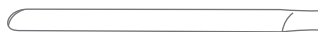



Septum Chisels, Septum Gouges
Septummeißel, Septum-Hohlmeißel
Cinceles para tabique nasal, Gubias para tabique nasal
Élévateurs pour le périoste, Gouges pour la cloison nasale
Elevatori per il periosto, Sgorbie per il setto nasale

Killian Septum Gouge
Bayonet Shaped

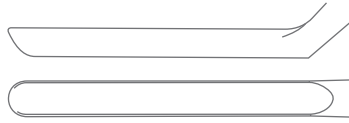

Catalog #	Size, Blade Width
74-613-16	16 cm (6 1/4"), 8.0 mm



Killian-Claus Septum Gouge
Bayonet Shaped

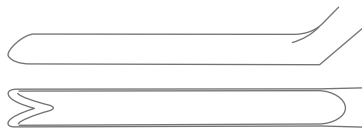

Catalog #	Size, Blade Width
74-615-16	16 cm (6 1/4"), 5.0 mm



Cottle Osteotome
Straight

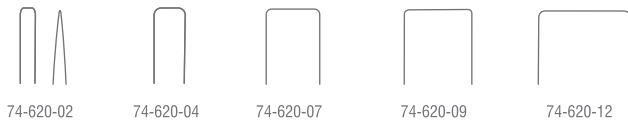

Catalog #	Size, Blade Width
74-620-02	18.5 cm (7 1/4"), 2.0 mm
74-620-04	18.5 cm (7 1/4"), 4.0 mm
74-620-07	18.5 cm (7 1/4"), 7.0 mm
74-620-09	18.5 cm (7 1/4"), 9.0 mm
74-620-12	18.5 cm (7 1/4"), 12.0 mm



Cottle Osteotome
Curved



Catalog #	Size, Blade Width
74-621-02	18.5 cm (7 1/4"), 2.0 mm
74-621-04	18.5 cm (7 1/4"), 4.0 mm
74-621-06	18.5 cm (7 1/4"), 6.0 mm
74-621-09	18.5 cm (7 1/4"), 9.0 mm
74-621-12	18.5 cm (7 1/4"), 12.0 mm



Osteotomes, Chisels
Osteotome, Meißel
Osteótomos, Cinceles
Ostéotomes, Ciseaux-burins
Osteotomi, Scalpelli

Cottle Chisel
Straight , Cross Handle

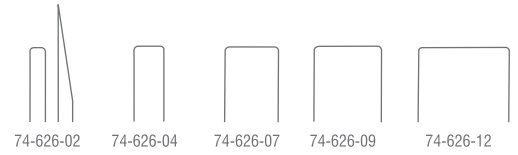

Catalog #	Size, Blade Width
74-626-02	18.5 cm (7 1/4"), 2.0 mm
74-626-04	18.5 cm (7 1/4"), 4.0 mm
74-626-07	18.5 cm (7 1/4"), 7.0 mm
74-626-09	18.5 cm (7 1/4"), 9.0 mm
74-626-12	18.5 cm (7 1/4"), 12.0 mm



Cottle Chisel
Curved, Cross Handle

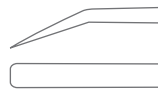

Catalog #	Size, Blade Width
74-627-06	18.5 cm (7 1/4"), 6.0 mm



Cottle Osteotome

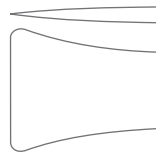

Catalog #	Size, Blade Width
74-630-16	18.5 cm (7 1/4"), 16.0 mm



Cottle Osteotome
Cross Handle

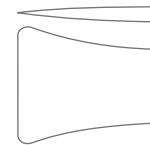

Catalog #	Size, Blade Width
74-632-16	18.5 cm (7 1/4"), 16.0 mm





Osteotomes, Chisels
Osteotome, Meißel
Osteótomos, Cinceles
Ostéotomes, Ciseaux-burins
Osteotomi, Scalpelli

Rubin Osteotome

Catalog #	Size, Blade Width
74-636-10	18.5 cm (7 1/4"), 10.0 mm
74-636-12	18.5 cm (7 1/4"), 12.0 mm
74-636-14	18.5 cm (7 1/4"), 14.0 mm

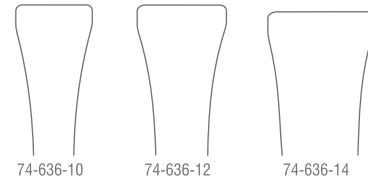

Walter Chisel

Catalog #	Size, Blade Width
74-640-03	9 cm (7 1/2"), 3.0 mm
74-640-04	9 cm (7 1/2"), 4.5 mm



Walter Osteotome

Catalog #	Size, Blade Width
74-642-03	19 cm (7 1/2"), 3.0 mm
74-642-04	19 cm (7 1/2"), 4.0 mm
74-642-07	19 cm (7 1/2"), 7.0 mm
74-642-09?	19 cm (7 1/2"), 9.0 mm
74-642-12	19 cm (7 1/2"), 12.0 mm

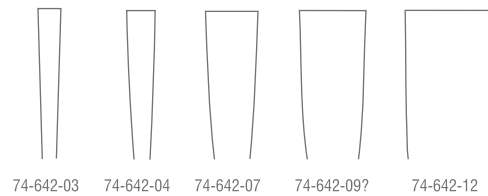

Fomon Chisel

Catalog #	Size, Blade Width
74-648-04	16 cm (6 1/4"), 4.0 mm
74-648-05	16 cm (6 1/4"), 5.0 mm
74-648-06	16 cm (6 1/4"), 6.0 mm
74-648-07?	16 cm (6 1/4"), 7.0 mm

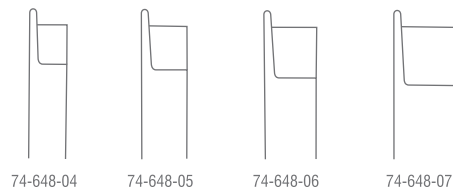

Rhinoplastic Chisels, Chisels
Nasenmeißel, Meißel
Cinceles nasales, Cinceles
Ciseaux-burins nasaux, Ciseaux-burins
Scalpelli nasali, Scalpelli

Cinelli Osteotome

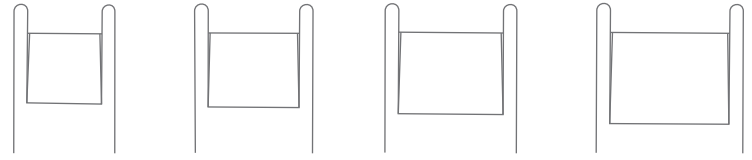

74-650-10

74-650-12

74-650-14

74-650-16

Catalog #	Size, Blade Width
74-650-10	16 cm (6 1/4"), 10.0 mm
74-650-12	16 cm (6 1/4"), 12.0 mm
74-650-14	16 cm (6 1/4"), 14.0 mm
74-650-16	16 cm (6 1/4"), 16.0 mm



Neivert-Anderson Osteotome

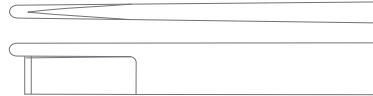

Catalog #	Size, Blade Width
74-654-07	20.5 cm (8"), 7.0 mm



**Neivert-Anderson Osteotome
Left**

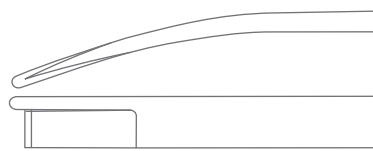

Catalog #	Size, Blade Width
74-655-07	20.5 cm (8"), 7.0 mm



**Neivert-Anderson Osteotome
Right**

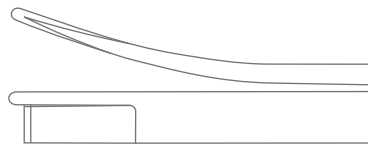

Catalog #	Size, Blade Width
74-657-07	20.5 cm (8"), 7.0 mm





Rhinoplastic Chisels, Chisels
Nasenmeißel, Meißel
Cinceles nasales, Cinceles
Ciseaux-burins nasaux, Ciseaux-burins
Scalpelli nasali, Scalpelli

Cottle Chisel

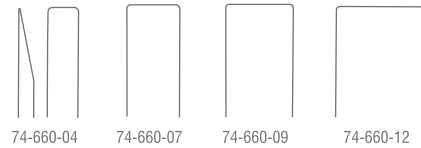

Catalog #	Size, Blade Width
74-660-04	18 cm (7"), 4.0 mm
74-660-07	18 cm (7"), 7.0 mm
74-660-09	18 cm (7"), 9.0 mm
74-660-12	18 cm (7"), 12.0 mm



Sheehan Osteotome

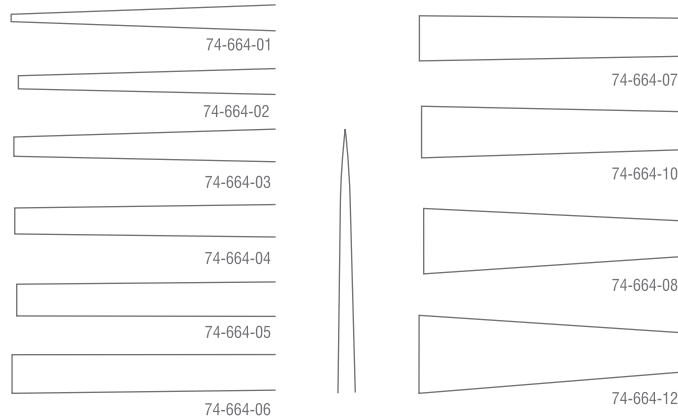

Catalog #	Size, Blade Width
74-664-01	15 cm (6"), 1.0 mm
74-664-02	15 cm (6"), 2.0 mm
74-664-03	15 cm (6"), 3.0 mm
74-664-04	15 cm (6"), 4.0 mm
74-664-05	15 cm (6"), 5.0 mm
74-664-06	15 cm (6"), 6.0 mm
74-664-07	15 cm (6"), 7.0 mm
74-664-08	15 cm (6"), 8.0 mm
74-664-10	15 cm (6"), 10.0 mm
74-664-12	15 cm (6"), 12.0 mm



**Silver Chisel
Straight**



Catalog #	Size, Blade Width
74-666-05	18 cm (7"), 5.0 mm



**Silver Chisel
Right**

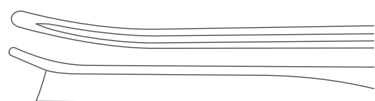

Catalog #	Size, Blade Width
74-667-05	18 cm (7"), 5.0 mm



Rhinoplastic Chisels, Chisels, Nasal Saws
 Nasenmeißel, Meißel, Nasensägen
 Cinceles nasales, Cinceles, Sierras nasales
 Ciseaux-burins nasaux, Ciseaux-burins, Scies nasales
 Scalpelli nasali, Scalpelli, Seghe nasali

Silver Chisel
Left Curved

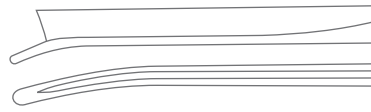

Catalog #	Size, Blade Width
74-669-05	18 cm (7"), 5.0 mm

Parkes Osteotome

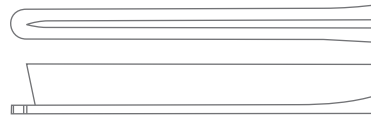

Catalog #	Size
74-672-01	16 cm (6 1/4")

Joseph Nasal Saw



Catalog #	Size, Profile
74-691-01?	17 cm (6 3/4"), Angled to Left
74-691-02	17 cm (6 3/4"), Angled to Right

Joseph Nasal Saw
Straight



Catalog #	Size, Working Length
74-692-19	19 cm (7 1/2"), 40.0 mm

Joseph Nasal Saw
Bayonet Shaped



Catalog #	Size, Working Length
74-693-01	19 cm (7 1/2"), 40.0 mm
74-693-02	19 cm (7 1/2"), 40.0 mm

74-693-01

74-693-02

INCHES
MILLIMETERS



Cartilage Crusher, Nasal Rasps, Bone Files, Antrum Rasps
Knorpelquetsche, Nasenraspeln, Knochenfeilen, Antrumraspeln
Machacadora, Escofinas nasales, Limas para huesos, Escofinas para el antro
Pincers-gouge à cartilage, Râpes nasales, Limes à os, Râpes pour antre
Torchio per cartilagine, Raspe nasali, Lime per ossa, Raspe per seno mascellare

Cottle Cartilage Crusher



Catalog #	Size
74-698-00	Standard

Miller-Colburn Bone File Drawing Cut

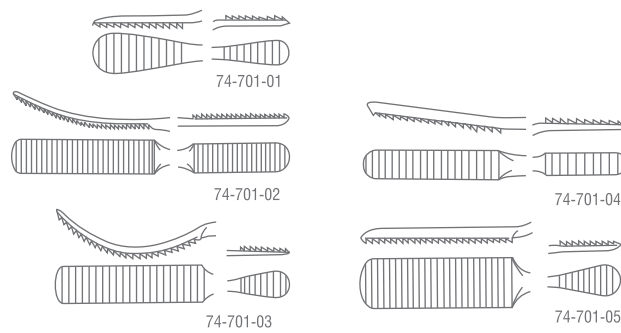

Catalog #	Size, Profile
74-701-01	18 cm (7"), Fig. 1
74-701-02	18 cm (7"), Fig. 2
74-701-03	18 cm (7"), Fig. 3
74-701-04	18 cm (7"), Fig. 4
74-701-05	18 cm (7"), Fig. 5



Miller-Colburn Bone File Cross Cut

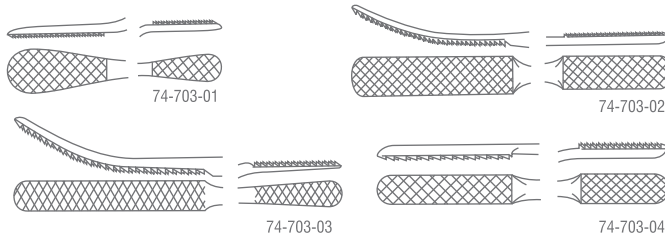

Catalog #	Size, Profile
74-703-01	18 cm (7"), Fig. 1
74-703-02	18 cm (7"), Fig. 2
74-703-03	18 cm (7")?, Fig. 3
74-703-04	18 cm (7"), Fig. 4



UltraCut™ TC Miller Bone File Drawing Cut

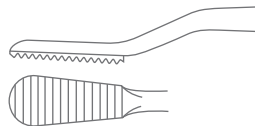

ULTRA *Cut*

Catalog #	Size
74-705-01	19 cm (7 1/2")



Nasal Rasps, Bone Files, Antrum Rasps
 Nasenraspeln, Knochenfeilen, Antrumraspeln
 Escofinas nasales, Limas para huesos, Escofinas para el antro
 Râpes nasales, Limes à os, Râpes pour antre
 Raspe nasali, Lime per ossa, Raspe per seno mascellare

UltraCut™ TC Miller Bone File
 Cross Cut

ULTRACut™

Catalog #	Size
74-707-01	19 cm (7 1/2")



Maltz Nasal Rasp
 Drawing Cut

Catalog #	Size, Cutting Edge
74-710-18	17.5 cm (7"), 40 x 9 mm

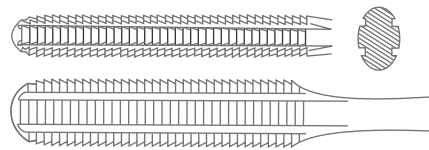

Maltz Nasal Rasp

Catalog #	Size, Cutting Edge, Profile
74-712-01	17 cm (6 3/4"), 34 x 7 mm, Drawing Cut
74-712-02	17 cm (6 3/4"), 34 x 7 mm, Pushing Cut

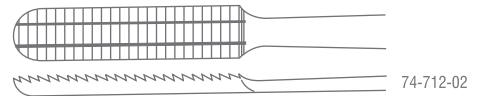
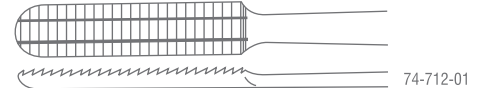

Joseph Bone File

Catalog #	Size, Cutting Edge
74-714-01	16 cm (6 1/4"), 60 x 8 mm
74-714-02	16 cm (6 1/4"), 45 x 9 mm

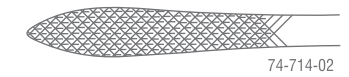
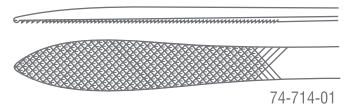

Fomon Bone File

Catalog #	Size, Cutting Edge, Profile
74-720-01	21 cm (8 1/4"), 30 x 8 mm, Fine
74-720-02	21 cm (8 1/4"), 30 x 8 mm, Coarse

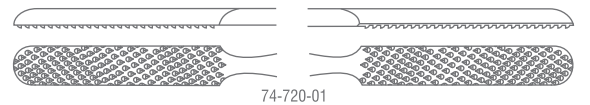



Nasal Rasps, Bone Files, Antrum Rasps
 Nasenraspeln, Knochenfeilen, Antrumraspeln
 Escofinas nasales, Limas para huesos, Escofinas para el antro
 Râpes nasales, Limes à os, Râpes pour antre
 Raspe nasali, Lime per ossa, Raspe per seno mascellare

Parkes Bone File
Drawing Cut

Catalog #	Size, Cutting Edge
74-722-01	19.5 cm (7 3/4"), 35 x 8 mm
74-722-02	19.5 cm (7 3/4"), 35 x 10 mm

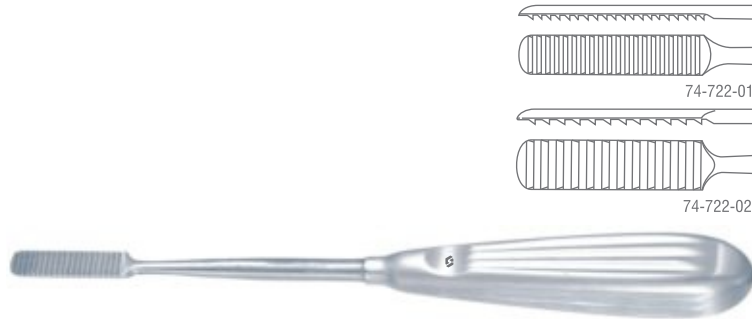

Gallaher Antrum Rasp

Catalog #	Size, Cutting Edge, Profile
74-724-01	17 cm (6 3/4"), 45 x 6 mm, Straight
74-724-02	17 cm (6 3/4"), 45 x 6 mm, Left
74-724-03	17 cm (6 3/4"), 45 x 6 mm, Right



Cottle Nasal Rasp

Catalog #	Size, Cutting Edge
74-726-21	20.5 cm (8"), 30 x 8 mm

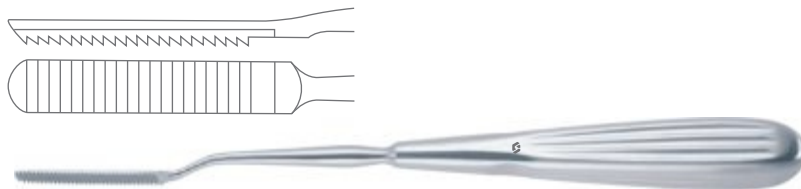

Aufricht Glabella Rasp

Catalog #	Size, Cutting Edge, Profile
74-729-01	21 cm (8 1/4"), 32 x 9 mm, Pushing Cut
74-729-02	21 cm (8 1/4"), 32 x 9 mm, Drawing Cut



Lewis Nasal Rasp
Drawing Cut

Catalog #	Size, Cutting Edge, Profile
74-732-01	19 cm (7 1/2"), 15 x 8 mm, Fine
74-732-02	19 cm (7 1/2"), 15 x 8 mm, Coarse



Nasal Rasps, Bone Files, Antrum Rasps
 Nasenraspeln, Knochenfeilen, Antrumraspeln
 Escofinas nasales, Limas para huesos, Escofinas para el antro
 Râpes nasales, Limes à os, Râpes pour antre
 Raspe nasali, Lime per ossa, Raspe per seno mascellare

Wiener Nasal Rasp

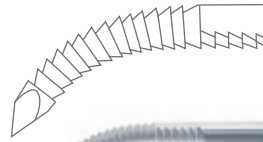

Catalog #	Size
74-735-18	18 cm (7")

**Diam-n-Dust™ Bone File
Straight**



DIAM-N-DUST



Catalog #	Size
74-738-19	19 cm (7 1/2")

**Diam-n-Dust™ Bone File
Curved**



DIAM-N-DUST

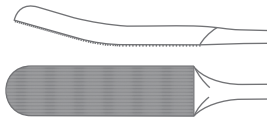

Catalog #	Size
74-739-19	19 cm (7 1/2")

UltraCut™ TC Maltz Nasal Rasp

ULTRA Cut™



Catalog #	Size
74-742-01	19.5 cm (7 3/4")
74-742-02	19.5 cm (7 3/4")
74-742-03	19.5 cm (7 3/4")
74-742-04	19.5 cm (7 3/4")
74-742-05	19.5 cm (7 3/4")
74-742-06	19.5 cm (7 3/4")
74-742-07	19.5 cm (7 3/4")
74-742-08	19.5 cm (7 3/4")
74-742-09	19.5 cm (7 3/4")
74-742-10	19.5 cm (7 3/4")



74-742-01

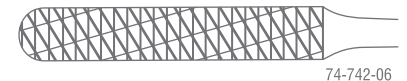

74-742-06



74-742-02

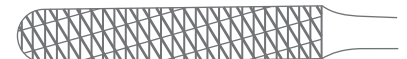

74-742-07



74-742-03



74-742-08



74-742-04



74-742-09



74-742-05



74-742-10

INCHES
MILLIMETERS



Nasal Rasps, Antrum Rasps
Nasenraspeln, Antrumraspeln
Escofinas nasales, Escofinas para el antro
Râpes nasales, Râpes pour antre
Raspe nasali, Raspe per seno mascellare

Fomon Nasal Rasp

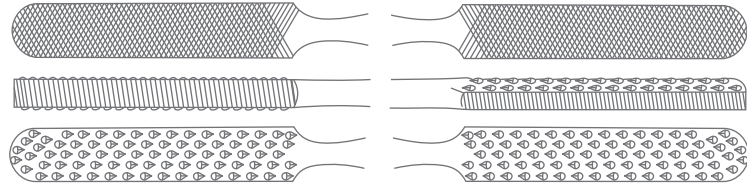

Catalog # Size, Cutting Edge
74-744-21 20.5 cm (8"), 30 x 8 mm



UltraCut™ Fomon Nasal Rasp
Fig. 1 -2

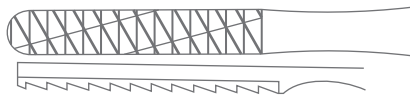

ULTRACut™

Catalog # Size, Cutting Edge
74-746-01 20.5 cm (8"), 30 x 8 mm

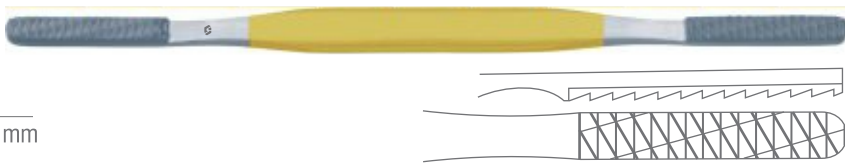

UltraCut™ Fomon Nasal Rasp
Fig. 3 -4

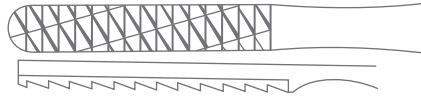

ULTRACut™

Catalog # Size, Cutting Edge
74-746-02 20.5 cm (8"), 40 x 7 mm



UltraCut™ Fomon Nasal Rasp
Fig. 5 -6

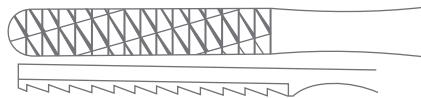

ULTRACut™

Catalog # Size, Cutting Edge
74-746-03 20.5 cm (8"), 40 x 7 mm

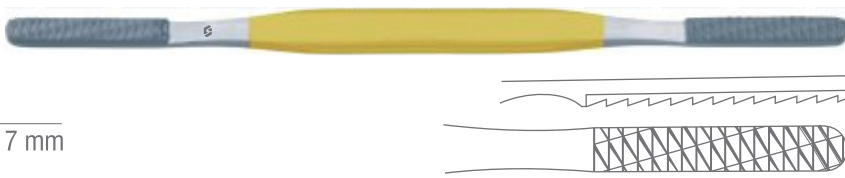

UltraCut™ Fomon Nasal Rasp
Fig. 7 -8

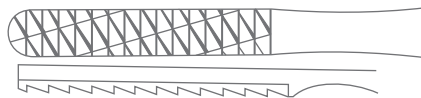

ULTRACut™

Catalog # Size, Cutting Edge
74-746-04 20.5 cm (8"), 40 x 7 mm

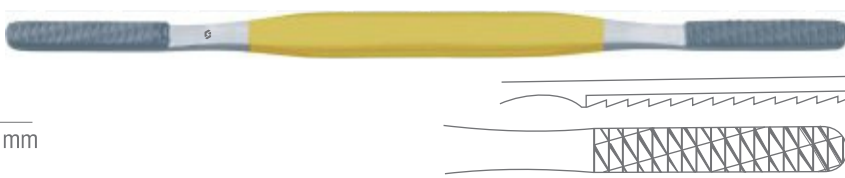

Alar Hooklets, Mucosa Hooklet
 Nasenflügelhäkchen, Schleimhauthäkchen
 Ganchitos para alas de nariz, Ganchito para mucosa
 Crochets pour les ailes du nez, Crochet pour la muqueuse
 Uncini per le pinne nasali, Uncino per mucosa

UltraCut™ Fomon Nasal Rasp
 Fig. 9 -10

ULTRA Cut™

Catalog #	Size, Cutting Edge
74-746-05	20.5 cm (8"), 40 x 7 mm

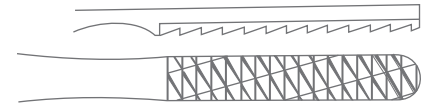
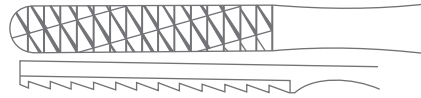

Lange Alar Hook
 Button End

Catalog #	Size
74-761-22	23 cm (9")



Fomon Alar Hook
 Button End

Catalog #	Size
74-763-17	17 cm (6 3/4")



Fomon Alar Hook
 Button End

Catalog #	Size
74-765-16	16 cm (6 1/4")

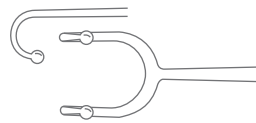

Cottle-Neivert Alar Hook

Catalog #	Size
74-767-20	19.5 cm (7 3/4")

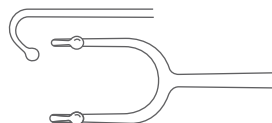



Alar Hooklets, Nasal Retractors
Nasenflügelhäkchen, Nasenhaken
Ganchitos para alas de nariz, Separadores nasales
Crochets pour les ailes du nez, Ecarteurs nasaux
Uncini per le pinne nasali, Divaricatori nasali

Cottle Alar Hook

Catalog #	Size
74-771-01	14.5 cm (5 ¾"), Sharp
74-771-02	14.5 cm (5 ¾"), Blunt, Sharp
74-771-03	14.5 cm (5 ¾"), Sharp, Blunt

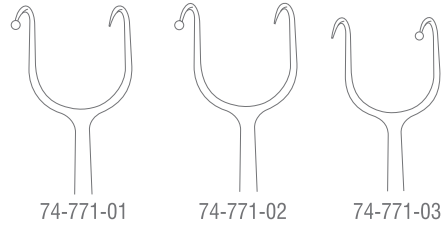

Converse Nasal Retractor

Catalog #	Size, Blade Size
74-781-01	9 cm (3 ½"), 18 x 9.5 mm
74-781-02	9 cm (3 ½"), 28 x 12.5 mm
74-781-03	9 cm (3 ½"), 41 x 13.5 mm
74-781-04	9 cm (3 ½"), 53 x 13.5 mm

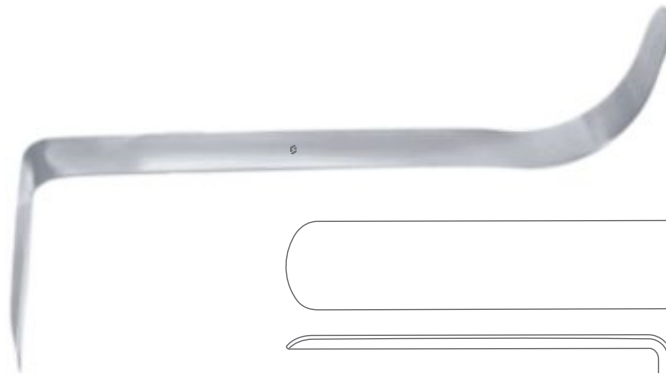

Aufricht Nasal Retractor

Catalog #	Size, Blade Size
74-785-19	19 cm (7 ½"), 40 x 12 mm

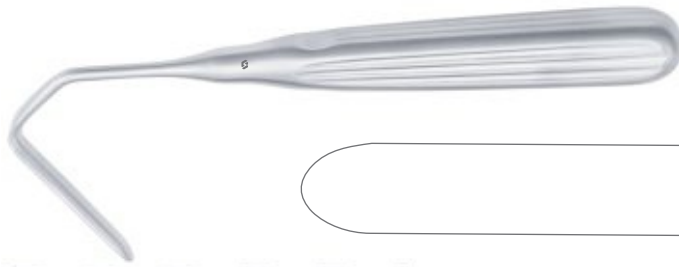

Converse Nasal Retractor

Catalog #	Size, Blade Size
74-787-11	10.5 cm (4"), 44 x 11 mm





Alar Hooklets, Nasal Retractors, Septum Forceps, Septum Straightening Forceps
 Nasenflügelhäkchen, Nasenhaken, Septumzangen, Septumrichtzangen
 Ganchitos para alas de nariz, Separadores nasales, Pinzas para tabique nasal, Pinzas para enderezar el tabique nasal
 Crochets pour les ailes du nez, Ecarteurs nasaux, Pincés pour la cloison nasale, Pincés pour le redressement de la cloison nasale
 Uncini per le pinne nasali, Divaricatori nasali, Pinze per il setto nasale, Pinze per raddizzare il setto nasale

Neivert Nasal Retractor



Catalog #	Size
74-789-16	17 cm (6 3/4")

Cottle Alar Retractor



Catalog #	Size
74-791-15	16 cm (6 1/4")

**Aufricht Nasal Retractor
Blunt**



Catalog #	Size, Blade Size
74-793-14	12 cm (4 3/4"), 60 x 6.5 mm

Kressner Septum Forcep



Catalog #	Size
74-801-20	21 cm (8 1/4")

Cottle-Walsham Septum Straightening Forcep

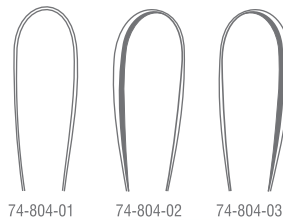

74-804-01 74-804-02 74-804-03

Catalog #	Size, Profile
74-804-01	23 cm (9"), Straight
74-804-02	23 cm (9"), Left
74-804-03	23 cm (9"), Right



INCHES
MILLIMETERS



Septum Forceps, Septum Straightening Forceps, Skin Grasping Forceps
Septumzangen, Septumrichtzangen, Hautfasspinzetten
Pinzas para tabique nasal, Pinzas para enderezar el tabique nasal, Pinzas para piel
Pinces pour la cloison nasale, Pinces pour le redressement de la cloison nasale, Pinces pour saisir la peau
Pinze per il setto nasale, Pinze per raddizzare il setto nasale, Pinze per afferrare la pelle

Asch Septum Straightening Forcep



Catalog # Size
74-807-23 22.5 cm (8 3/4")

Aiach Columella Suturing Forcep



Catalog # Size, Width
74-811-15 15.5 cm (6"), 5.0 mm

Ogura Skin Grasping Forcep



Catalog # Size, Width
74-814-11 11 cm (4 1/4"), 4.0 mm

Cottle Sking Grasping Forcep



Catalog # Size, Width
74-817-14 14 cm (5 1/2"), 1.7 mm

Cottle Columella Forcep



Catalog # Size, Width
74-820-11 11 cm (4 1/4"), 12.0 mm

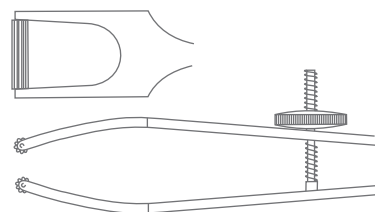

Antrum Curettes, Adenoid Curettes
Antrumküretten, Ringmesser
Curetas para el antro, Cuchillos para adenoides
Curettes pour l'antre, Couteaux à végétations adénoïdales
Curette per antro, Coltelli per vegetazioni adenoidee

Faulkner Antrum Curette



Catalog #	Size
74-839-21	21 cm (8 1/4")

Coakley Antrum Curette

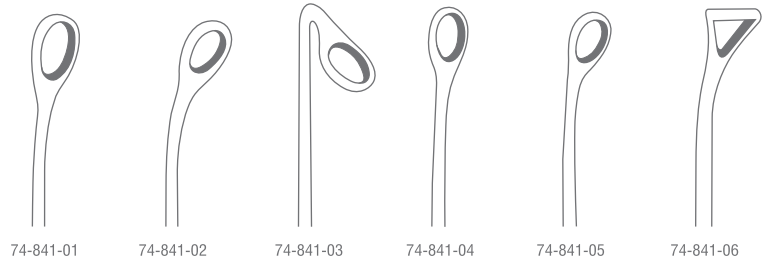

Catalog #	Size
74-841-01	17 cm (6 3/4")
74-841-02	17 cm (6 3/4")
74-841-03	17 cm (6 3/4")
74-841-04	17 cm (6 3/4")
74-841-05	17 cm (6 3/4")
74-841-06	17 cm (6 3/4")



Beckmann Adenoid Curette

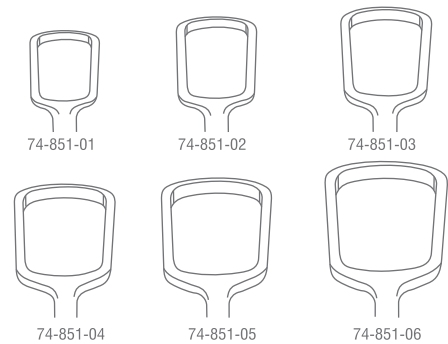

Catalog #	Size, Width, Profile
74-851-01	22.5 cm (8 3/4"), 13.0 mm, Fig. 1
74-851-02	22.5 cm (8 3/4"), 15.0 mm, Fig. 2
74-851-03	22.5 cm (8 3/4"), 17.0 mm, Fig. 3
74-851-04	22.5 cm (8 3/4"), 19.0 mm, Fig. 4
74-851-05	22.5 cm (8 3/4"), 21.0 mm, Fig. 5
74-851-06	22.5 cm (8 3/4"), 23.0 mm, Fig. 6



**Beckmann Adenoid Curette
Angled Shaft**

Catalog #	Size, Width, Profile
74-853-01	22 cm (8 3/4"), 13.0 mm, Fig. 1
74-853-02	22 cm (8 3/4"), 15.0 mm, Fig. 2
74-853-03	22 cm (8 3/4"), 17.0 mm, Fig. 3
74-853-04	22 cm (8 3/4"), 19.0 mm, Fig. 4
74-853-05	22 cm (8 3/4"), 21.0 mm, Fig. 5
74-853-06	22 cm (8 3/4"), 23.0 mm, Fig. 6





Barnhill Adenoid Curette



Catalog #	Size, Profile
74-855-01	22 cm (8 3/4"), 11 mm, Fig. 1
74-855-02	22 cm (8 3/4"), 13 mm, Fig. 2
74-855-03	22 cm (8 3/4"), 15 mm, Fig. 3
74-855-04	22 cm (8 3/4"), 17 mm, Fig. 4
74-855-05	22 cm (8 3/4"), 19 mm, Fig. 5

St. Clair Thompson Adenoid Curette



Catalog #	Size, Profile
74-857-01	21 cm (8 1/4"), 10 mm, Fig. 1
74-857-02	21 cm (8 1/4"), 12 mm, Fig. 2
74-857-03	21 cm (8 1/4"), 14 mm, Fig. 3
74-857-04	21 cm (8 1/4"), 16 mm, Fig. 4

LaForce Adenotome
With Non-Perforated Blade



Catalog #	Size, Profile
74-861-01	25 cm (9 3/4"), Fig. 1
74-861-02	25 cm (9 3/4"), Fig. 2
74-861-03	25 cm (9 3/4"), Fig. 3

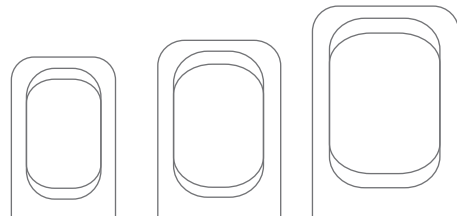

74-861-01

74-861-02

74-861-03

Adenoid Curettes
Ringmesser
Cuchillos para adenoides
Couteaux à végétations adénoïdales
Coltelli per vegetazioni adenoidee

LaForce Blade
Non-Perforated

Catalog #	Size
74-861-11	Small
74-861-12	Medium
74-861-13	Large



LaForce Adenotome
With Perforated Blade

Catalog #	Size, Profile
74-863-01	25 cm (9 3/4"), Fig. 1
74-863-02	25 cm (9 3/4"), Fig. 2
74-863-03	25 cm (9 3/4"), Fig. 3

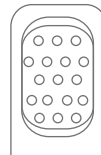

74-863-01

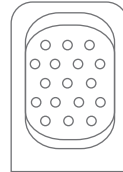

74-863-02

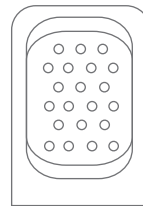

74-863-03

LaForce Blade
Perforated

Catalog #	Size
74-863-11	Small
74-863-12	Medium
74-863-13	Large



Eicken-Killian Irrigation

Catalog #	Size, Diameter
74-881-20	14 cm (5 1/2"), Ø 2.0 mm
74-881-25	14 cm (5 1/2"), Ø 2.5 mm
74-881-30	14 cm (5 1/2"), Ø 3.0 mm





Frontal Sinus Dilators
Sinus-Dilatatoren
Dilatadores para el seno
Dilatateurs pour le sinus frontal
Dilatatori per il seno frontale

Ritter-Halle Frontal Sinus Dilator

Catalog #	Size, Diameter
74-891-25	14.5 cm (5 ¾"), Ø 2.5 mm
74-891-30	14.5 cm (5 ¾"), Ø 3.0 mm
74-891-40	14.5 cm (5 ¾"), Ø 4.0 mm





TONSILLECTOMY, LARYNGO-BRONCHOSCOPY

SunMark Laryngology Instruments are precision crafted to help you minimize trauma when operating on or near delicate vocal cords during laryngeal surgery, microlaryngeal surgery and phonosurgery.

SunMark offers a wide range of Tonsillectomy & Laryngobronchoscopy Instruments in this field of medicine including but not limited to the following tonsil dissectors, knives, tonsil elevators, tonsil ligators, gauze packer, tonsil forceps, tonsil snares, tonsillectomes, tonsil punches, broncho-esophagoscopy forceps, laryngeal forceps, laryngeal mirrors.

Tonsillektomie, Laryngo-Bronchoskopie

Tonsilectomía, Laringo-Bronchoscopia

Tonsillectomie, Laryngo-Bronchoscopie

Tonsilectomia, Laringo-Bronchoscopia



Tonsil Dissector / Retractors
Tonsillenelevator / Retractor
Disector / Separador para amígdalas
Dissecteur / Rétracteur pour amygdalas
Disettori / Retrattori per tonsille

Fischer Tonsil / Dissector



Catalog #	Size
85-011-21	21.5 cm (8 1/2")

Abraham Tonsil Knife



Catalog #	Size
85-015-19	19 cm (7 1/2")

Carpenter Tonsil Knife

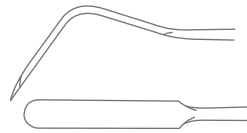

Catalog #	Size, Blade Width
85-021-25	25 cm (9 3/4"), 4.4 mm, 8.8 mm

Carpenter Tonsil Dissector



Catalog #	Size
85-027-24	24 cm (9 1/2")

Hurd Tonsil Dissector / Retractor



Catalog #	Size, Blade Width
85-031-22	22.5 cm (8 3/4"), 11.0, 14.0 mm

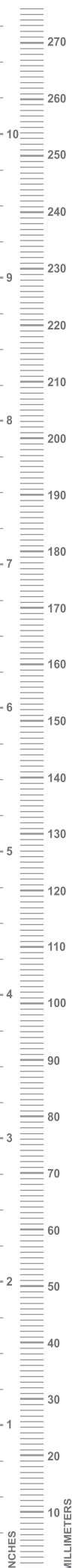
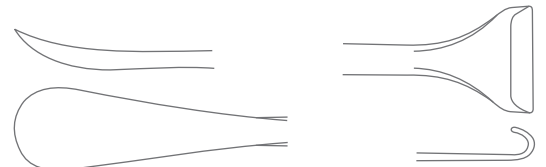



Tonsil Elevator / Retractors
Tonsil Aufzüge / Wundhaken
Amígdalas Elevadores / Separadores
Amygdale Ascenseurs / Ecarteurs
Tonsille Ascensori / Divaricatori

Mollison Tonsil Dissector/Retractor



Catalog #	Size, Blade Width
85-033-21	21 cm (8 1/4"), 10.0 mm, 10 mm

Henke Tonsil Elevator

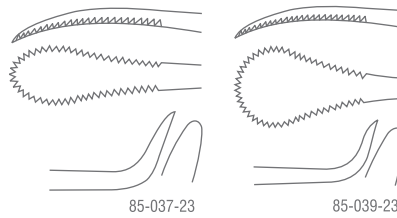

Catalog #	Size, Blade Width
85-037-23	22.5 cm (8 3/4"), 10.0, 5.0 mm
85-039-23	22.5 cm (8 3/4"), 16.0, 5.0 mm



Gwynne-Evans Tonsil Elevator



Catalog #	Size
85-043-22	20 cm (8")

Love Tonsil Retractor



Catalog #	Size, Blade Width
85-051-18	20 cm (8"), 18 mm
85-051-20	23 cm (9"), 20 mm
85-051-22	23 cm (9"), 22 mm

Nager Tonsil Retractor



Catalog #	Size
85-055-23	23 cm (9")

Tonsil Instruments
Tonsil Instrumente
Instrumentos de la amigdala
Instruments de amygdales
Strumenti Tonsille

Hofer Tonsil Retractor



Catalog #	Size
85-059-24	24 cm (9 1/2")

Haslinger Tonsil Retractor



Catalog #	Size
85-063-17	17 cm (6 3/4")

Roeder Tonsil Ligator



Catalog #	Size
85-065-00	26.5 cm (10 1/2")

Luniatschek Gauze Packer



Catalog #	Size, Width
85-073-19	17.5 cm (7"), 3 mm
85-073-20	17.5 cm (7"), 2 mm

White Tonsil Grasping Forcep



Catalog #	Size
85-101-18	18 cm (7")

INCHES
MILLIMETERS



Blohmke Tonsil Grasping Forcep
1 x 2 Teeth

Catalog #	Size
85-105-20	20 cm (8")

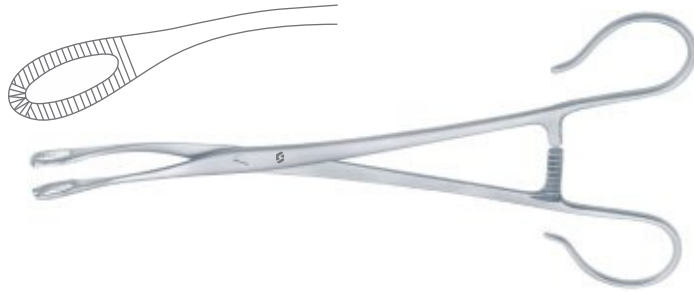

Schmidt Tonsil Forcep

Catalog #	Size, Profile
85-111-19	19 cm (7 1/2"), Slightly Curved
85-113-19	18.5 cm (7 1/4"), Strongly Curved

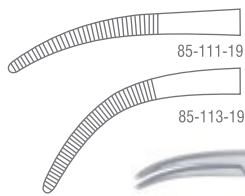

Wilson Tonsil Artery Forcep

Catalog #	Size
85-115-20	20 cm (8")



Colver Tonsil Grasping Forcep

Catalog #	Size, Profile
85-116-19	19 cm (7 1/2"), Straight
85-117-19	19 cm (7 1/2"), Curved

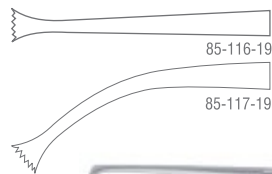

Denis-Browne Tonsil Holding Forcep
Curved

Catalog #	Size
85-119-22	22 cm (8 1/2")

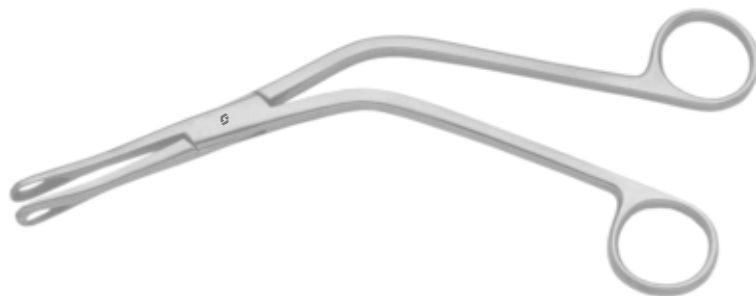

Tonsil Instruments
Tonsil Instrumente
Instrumentos de la amígdala
Instruments de amygdales
Strumenti Tonsille

Museux Tonsil Grasping Forcep
Curved



Catalog #	Size
85-120-20	20 cm (8")

Eves Tonsil Snare
Without Ratchet



Catalog #	Size
85-150-28	28.5 cm (11 1/4")

Eves Tonsil Snare
With Ratchet



Catalog #	Size
85-152-28	28.5 cm (11 1/4")

Bruenings Tonsil Snare
With Double Ratchet

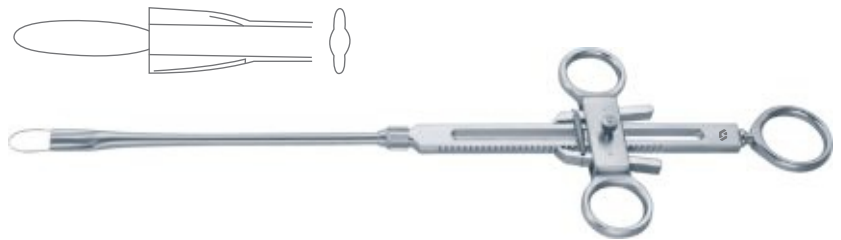

Catalog #	Size
85-156-29	29 cm (11 1/2")

Wire Loop for Tonsil Snare
Pack of 100

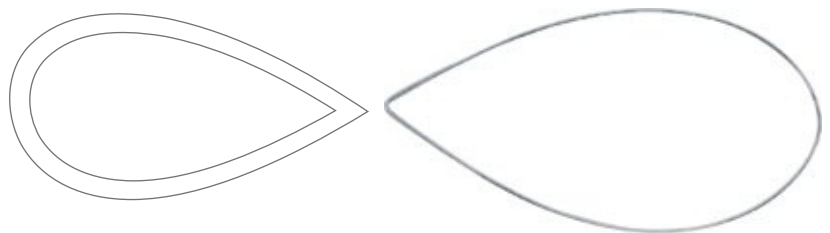

Catalog #	Size, Loop Diameter
85-161-40	Ø 40.0 mm
85-161-50	Ø 50.0 mm

INCHES
MILLIMETERS



Snare Wire
Pack of 100

Catalog #	Size, Wire Diameter
85-163-00	Ø 0.3 mm



Tyding Tonsil Snare
With 1 Straight Tip

Catalog #	Size
85-173-00	Standard



Sluder-Ballenger Tonsillectome Complete
With 3 Tip Ref: 85-183-01 to 85-183-03

Catalog #	Size
85-181-00	Standard



Sluder-Ballenger Tonsillectome Handle Only

Catalog #	Size
85-181-01	Standard



Sluder-Ballenger Tonsillectome Tip

Catalog #	Size, Profile
85-183-01	N/A, Fig. 1
85-183-02	N/A, Fig. 2
85-183-03	N/A, Fig. 3

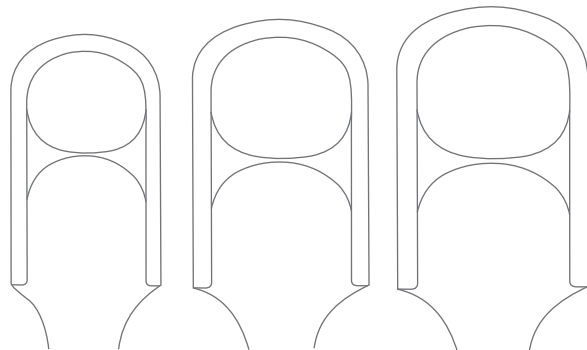

85-183-01

85-183-02

85-183-03

Tonsil Instruments
Tonsil Instrumente
Instrumentos de la amigdalada
Instruments de amygdales
Strumenti Tonsille

Corwin Tonsil Haemostat

Catalog #	Size
85-191-14	14 cm (5 1/2")



Hartmann Tonsil Punch
Through Cutting

Catalog #	Size, Diameter
85-201-13	12 cm (4 3/4"), Ø 13.0 mm
85-201-15	12 cm (4 3/4"), Ø 15.0 mm
85-201-17	12 cm (4 3/4"), Ø 17.0 mm



Schmeden Tonsil Punch
Through Cutting

Catalog #	Size
85-213-01	12 cm (4 3/4")
85-213-02	12 cm (4 3/4")
85-213-03	12 cm (4 3/4")



Jurasz
Adenoid Cutting Forcep

Catalog #	Size
85-215-01	21 cm (8 1/4")
85-215-02	21 cm (8 1/4")

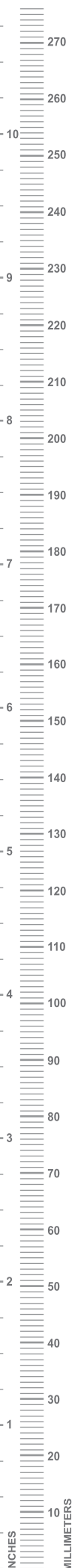
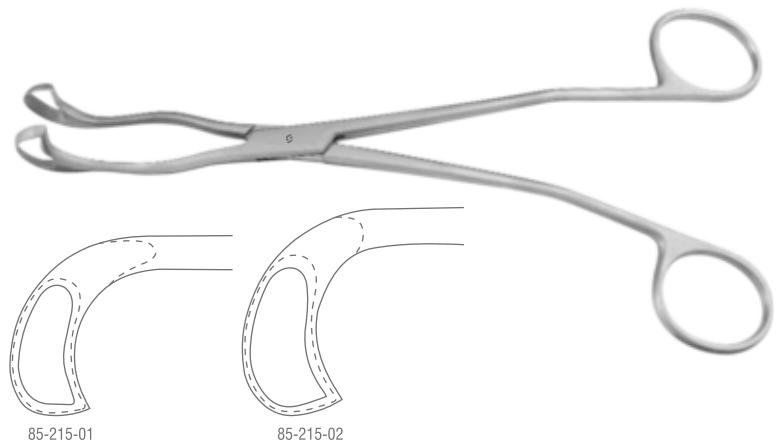



Huber Universal Handle

Catalog #	Size
85-301-01	Standard



Bruenings Interchangeable Tube
Straight

Catalog #	Size
85-302-20	20 cm (8")
85-302-30	30 cm (12")
85-302-40	40 cm (16")



Bruenings Interchangeable Tube
Curved

Catalog #	Size
85-303-20	20 cm (8")



Tonsil Instruments
Tonsil Instrumente
Instrumentos de la amigdalas
Instrumentos de amygdalas
Strumenti Tonsille

Fraenkel Broncho-Esophagoscopy Forcep Tip



Catalog #	Size
85-310-01	Standard

Seiffert Broncho-Esophagoscopy Forcep Tip

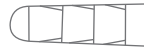

Catalog #	Size
85-314-01	Standard

Fraenkel Broncho-Esophagoscopy Forcep Tip



Catalog #	Size
85-318-01	Standard

Scheinmann Broncho-Esophagoscopy Forcep Tip



Catalog #	Size
85-321-01	Standard

Scheinmann Broncho-Esophagoscopy Forcep Tip



Catalog #	Size
85-323-01	Standard





Bruenings Broncho-Esophagoscopy Forcep Tip



Catalog #	Size
85-326-02	Standard
85-326-03	Standard

Bruenings Broncho-Esophagoscopy Forcep Tip



Catalog #	Size
85-328-02	Standard
85-328-03	Standard

Lange Broncho-Esophagoscopy Forcep Tip



Catalog #	Size
85-334-01	Standard

Krause Broncho-Esophagoscopy Forcep Tip

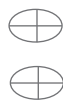

Catalog #	Size
85-338-01	Standard
85-338-02	Standard

Krause Broncho-Esophagoscopy Forcep Tip



Catalog #	Size
85-342-01	Standard

Tonsil Instruments
Tonsil Instrumente
Instrumentos de la amígdala
Instruments de amygdales
Strumenti Tonsille

Cordes Broncho-Esophagoscopy Forcep Tip

Catalog #	Size
85-347-01	Standard
85-347-02	Standard
85-347-03	Standard
85-347-04	Standard



Schumacher Broncho-Esophagoscopy Forcep Tip

Catalog #	Size
85-349-01	Standard



Cordes Broncho-Esophagoscopy Forcep Tip

Catalog #	Size
85-353-01	Standard
85-353-02	Standard



Cordes Broncho-Esophagoscopy Forcep Tip

Catalog #	Size
85-357-01	Standard



Rosenberg Broncho-Esophagoscopy Forcep Tip

Catalog #	Size
85-359-01	Standard





Micro Laryngeal Scissors

Catalog #	Shaft Length
85-361-01	25 cm
85-361-02	25 cm
85-361-03	25 cm
85-361-04	25 cm
85-361-05	25 cm
85-361-06	25 cm



Micro Laryngeal Forceps

Catalog #	Shaft Length
85-363-01	25 cm
85-363-02	25 cm
85-363-03	25 cm
85-363-04	25 cm
85-361-05	25 cm

Micro Scissors



Micro Forceps



**Cup Shaped Forceps
Ø 2.5 mm**



**Micro Laryngeal Forceps
Cup Shaped**

Catalog #	Shaft Length, Diameter
85-365-01	25 cm, Ø 2.5 mm
85-365-02	25 cm, Ø 2.5 mm
85-363-03	25 cm, Ø 2.5 mm
85-363-04	25 cm, Ø 2.5 mm
85-361-05	25 cm, Ø 2.5 mm
85-361-06	25 cm, Ø 2.5 mm





Microlaryngeal Instruments
Mikrolaryngeale Instrumente
Microlaryngeal Instrumentos
Instruments de Microlaryngeal
Strumenti Microlaryngeal

Micro Laryngeal Forceps *



Shaft Length 35 cm

Catalog #	Shaft Length
85-367-01	35 cm
85-367-02	35 cm
85-367-03	35 cm
85-367-04	35 cm, Ø 3.0 mm
85-367-05	35 cm, Ø 3.0 mm
85-367-06	35 cm, Ø 3.0 mm
85-367-07	35 cm, Ø 3.0 mm
85-367-08	35 cm, Ø 3.0 mm
85-367-09	35 cm, 2 x 5 mm
85-367-10	35 cm, 3 x 5 mm
85-367-11	35 cm

Micro Laryngeal Forceps *

Catalog #	Shaft Length
85-369-01	40 cm
85-369-02	40 cm
85-369-03	40 cm
85-369-04	40 cm
85-369-05	40 cm
85-369-06	40 cm
85-369-07	40 cm
85-369-08	40 cm
85-369-09	40 cm
85-369-10	40 cm
85-369-11	40 cm
85-369-12	40 cm
85-369-13	40 cm



















Micro Laryngeal Forceps *

Catalog #	Shaft Length
85-371-01	50 cm
85-371-02	50 cm
85-371-03	50 cm
85-371-04	50 cm
85-371-05	50 cm
85-371-06	50 cm
85-371-07	50 cm
85-371-08	50 cm
85-371-09	50 cm
85-371-10	50 cm
85-371-11	50 cm
85-371-12	50 cm
85-371-13	50 cm

Micro Laryngeal Forceps *

Catalog #	Shaft Length
85-373-01	60 cm
85-373-02	60 cm
85-373-03	60 cm
85-373-04	60 cm
85-373-05	60 cm
85-373-06	60 cm
85-373-07	60 cm
85-373-08	60 cm
85-373-09	60 cm
85-373-10	60 cm
85-373-11	60 cm
85-373-12	60 cm
85-373-13	60 cm

* Please refer to the images on next page.

For Children	Shaft 35cm	For Adult	Shaft Size 40 cm	Shaft Size 50 cm	Shaft Size 60 cm
	85-367-01		85-369-01	85-371-01	85-373-01
	85-367-02		85-369-02	85-371-02	85-373-02
	85-367-03		85-369-03	85-371-03	85-373-03
	85-367-04		85-369-04	85-371-04	85-373-04
	85-367-05		85-369-05	85-371-05	85-373-05
	85-367-06		85-369-06	85-371-06	85-373-06
	85-367-07		85-369-07	85-371-07	85-373-07
	85-367-08		85-369-08	85-371-08	85-373-08
	85-367-09		85-369-09	85-371-09	85-373-09
	85-367-10		85-369-10	85-371-10	85-373-10
	85-367-11		85-369-11	85-371-11	85-373-11
			85-369-12	85-371-12	85-373-12
			85-369-13	85-371-13	85-373-13



Tonsillectomy Instruments
Tonsil Instrumente
Instrumentos de la amigdala
Instruments de amygdales
Strumenti Tonsille

Chevalier-Jackson Square Punch

Catalog #	Shaft Length
85-381-30	30 cm (12")
85-381-40	40 cm (15 3/4")
85-381-50	50 cm (19 1/2")
85-381-60	60 cm (23 1/2")



Chevalier-Jackson Grasping Forcep

Catalog #	Shaft Length
85-383-30	30 cm (12")
85-383-40	40 cm (15 3/4")
85-383-50	50 cm (19 1/2")
85-383-60	60 cm (23 1/2")



Chevalier-Jackson Grasping Forcep

Catalog #	Shaft Length
85-385-30	30 cm (12")
85-385-40	40 cm (15 3/4")
85-385-50	50 cm (19 1/2")
85-385-60	60 cm (23 1/2")



**Chevalier-Jackson Cup Shaped Biopsy Forcep
Straight**

Catalog #	Shaft Length
85-387-30	30 cm (12")
85-387-40	40 cm (15 3/4")
85-387-50	50 cm (19 1/2")
85-387-60	60 cm (23 1/2")

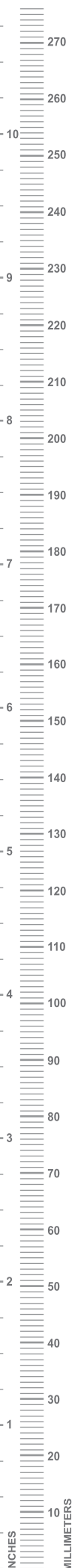



Chevalier-Jackson Basket Punch

Catalog #	Shaft Length
85-389-30	30 cm (12")
85-389-40	40 cm (15 3/4")
85-389-50	50 cm (19 1/2")
85-389-60	60 cm (23 1/2")



Chevalier-Jackson Oval Biopsy Forcep

Catalog #	Shaft Length
85-391-30	30 cm (12")
85-391-40	40 cm (15 3/4")
85-391-50	50 cm (19 1/2")
85-391-60	60 cm (23 1/2")



Chevalier-Jackson Cup Shaped Biopsy Forcep
Curved Upwards

Catalog #	Shaft Length
85-393-30	30 cm (12")
85-393-40	40 cm (15 3/4")
85-393-50	50 cm (19 1/2")
85-393-60	60 cm (23 1/2")

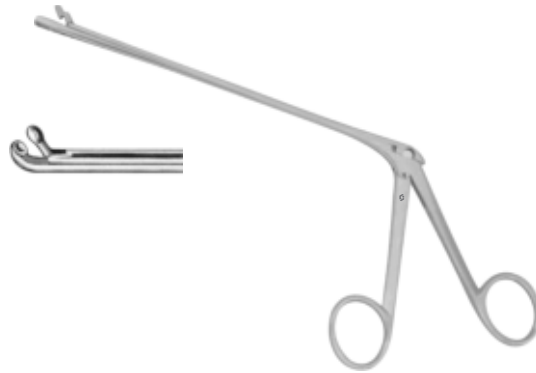

Micro Laryngeal Scissors

Catalog #	Size, Profile
85-395-01	25 cm (9 3/4"), Straight
85-395-02	25 cm (9 3/4"), Horizontal
85-395-03	25 cm (9 3/4"), Curved Right
85-395-04	25 cm (9 3/4"), Curved Left
85-395-05	25 cm (9 3/4"), Curved Up
85-395-06	25 cm (9 3/4"), Curved Down





Tonsil Instruments
Tonsil Instrumente
Instrumentos de la amígdala
Instruments de amygdales
Strumenti Tonsille

Laryngeal Mirror
Rhodium Plated With Fixed Handle

Catalog #	Size, Mirror Diameter, Profile
85-402-08	18.5 cm (7 1/4"), Ø 8 mm, Fig. 00
85-402-10	18.5 cm (7 1/4"), Ø 10 mm, Fig. 0
85-402-12	18.5 cm (7 1/4"), Ø 12 mm, Fig. 1
85-402-14	18.5 cm (7 1/4"), Ø 14 mm, Fig. 2
85-402-16	18.5 cm (7 1/4"), Ø 16 mm, Fig. 3
85-402-18	18.5 cm (7 1/4"), Ø 18 mm, Fig. 4
85-402-20	18.5 cm (7 1/4"), Ø 20 mm, Fig. 5
85-402-22	18.5 cm (7 1/4"), Ø 22 mm, Fig. 6
85-402-24	18.5 cm (7 1/4"), Ø 24 mm, Fig. 7
85-402-26	18.5 cm (7 1/4"), Ø 26 mm, Fig. 8
85-402-28	18.5 cm (7 1/4"), Ø 28 mm, Fig. 9
85-402-30	18.5 cm (7 1/4"), Ø 30 mm, Fig. 10



Laryngeal Mirror
Rhodium Plated Without Handle

Catalog #	Size, Mirror Diameter, Profile
85-406-08	13.5 cm (5 1/4"), Ø 8 mm, Fig. 00
85-406-10	13.5 cm (5 1/4"), Ø 10 mm, Fig. 0
85-406-12	13.5 cm (5 1/4"), Ø 12 mm, Fig. 1
85-406-14	13.5 cm (5 1/4"), Ø 14 mm, Fig. 2
85-406-16	13.5 cm (5 1/4"), Ø 16 mm, Fig. 3
85-406-18	13.5 cm (5 1/4"), Ø 18 mm, Fig. 4
85-406-20	13.5 cm (5 1/4"), Ø 20 mm, Fig. 5
85-406-22	13.5 cm (5 1/4"), Ø 22 mm, Fig. 6
85-406-24	13.5 cm (5 1/4"), Ø 24 mm, Fig. 7
85-406-26	13.5 cm (5 1/4"), Ø 26 mm, Fig. 8
85-406-28	13.5 cm (5 1/4"), Ø 28 mm, Fig. 9
85-406-30	13.5 cm (5 1/4"), Ø 30 mm, Fig. 10





Michel Laryngeal Mirror
With Handle , Moveable Mirror



Catalog #	Size, Mirror Diameter, Profile
85-413-12	25 cm (9 3/4"), Ø 12 mm, Fig. 1
85-413-14	25 cm (9 3/4"), Ø 14 mm, Fig. 2
85-413-16	25 cm (9 3/4"), Ø 16 mm, Fig. 3
85-413-18	25 cm (9 3/4"), Ø 18 mm, Fig. 4

Laryngeal Mirror Handle



Catalog #	Size
85-420-10	10 cm (4")



TRACHEOTOMY INSTRUMENTS

Tracheotomy consists of making an incision on the anterior aspect of the neck and opening a direct airway through an incision in the trachea (windpipe). The resulting stoma(hole), or tracheotomy, can serve independently as an airway or as a site for a tracheotomy tube to be inserted; this tube allows a person to breathe without the use of his or her nose or mouth. SunMark instruments offers a range of tracheotomy instruments for this medical procedure including but not limited to the following tracheal dilators, tracheal retractors, Goitre enucleators and tracheal tubes.

Tracheotomie

Traqueotomía

Trachéotomie

Tracheotomia

Tracheal Dilators, Tracheal Hooks
 Trachealdilatatoren, Trachealhaken
 Diladores traqueales, Ganchos traqueales
 Dilateurs pour la trachéotomie, Ecarteurs pour trachéotomie
 Dilatori per tracheotomia, Uncini tracheali

Uckermann Tracheotomy Trocar



Catalog #	Size, Diameter
86-101-75	11.5 cm (4 1/2"), Ø 7.5 mm
86-101-90	11.5 cm (4 1/2"), Ø 9.0 mm

Laborde Tracheal Dilator



Catalog #	Size
86-151-14	14 cm (5 1/2")

Trousseau Tracheal Dilator



Catalog #	Size
86-155-14	14.5 cm (5 3/4")

Bose Tracheal Retractor



Catalog #	Size
86-161-07	7 cm (2 3/4")

Bose Tracheal Retractor



Catalog #	Size
86-165-01	16 cm (6 1/4")
86-165-02	16 cm (6 1/4")





Iterson Tracheal Hook
Sharp



Catalog #	Size
86-171-16	17 cm (6 3/4")

Iterson Tracheal Hook
Blunt



Catalog #	Size
86-173-16	17 cm (6 3/4")

Schoeborn Tracheal Retractor



Catalog #	Size
86-181-21	21 cm (8 1/4")

Rose Tracheal Retractor



Catalog #	Size
86-183-13	13.5 cm (5 1/4")

Luer Tracheal Retractor



Catalog #	Size
86-185-11	11 cm (4 1/2")

Tracheal Hooks, Goitre Enucleator, Goitre Grasping Forceps
Trachealhaken, Kropfsonden, Kropffasszangen
Ganchos traqueales, Sondas para bocio, Pinzas para coger el bocio
Ecarteurs pour trachéotomie, Spatules à goitre, Pincés à goitre
Uncini tracheali, Sonde per gozzo, Pinze per gozzo

Lukens Thymus Retractor
Blunt



Catalog #	Size
86-189-17	17.5 cm (7")

Jackson Tracheal Hook



Catalog #	Size
86-191-17	18 cm (7")

Kocher Goiter Enucleator



Catalog #	Size
86-201-15	16.5 cm (6 1/2")

Kocher Goiter Enucleator
With Eye



Catalog #	Size
86-203-15	16.5 cm (6 1/2")

Lahey Goiter Grasping Forcep
2 x 2 Teeth

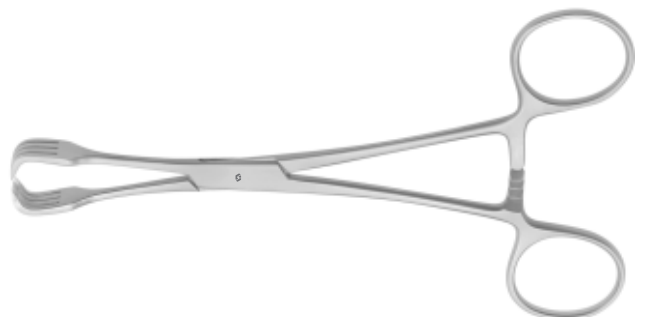

Catalog #	Size
86-250-15	15.5 cm (6")

INCHES
MILLIMETERS



Goitre Grasping Forceps, Tracheal Tubes
Kropffasszangen, Trachealkanülen
Pinzas para coger el bocio, Cánulas traqueales
Pinces à goitre, Canules tracheales
Pinze per gozzo, Cannule tracheali

Lahey Goiter Grasping Forcep

3 x 3 Teeth



Catalog #	Size
86-252-15	15.5 cm (6")
86-252-20	20 cm (8")

Luer Tracheal Tube

Catalog #	Size, Profile
86-301-04	45 mm, Ø 4.0, Fig. 0
86-301-05	40 mm, Ø 5.0, Fig. 1?
86-301-06	55 mm, Ø 6.0, Fig. 2
86-301-07	60 mm, Ø 7.0, Fig. 3
86-301-08	65 mm, Ø 8.0, Fig. 4?
86-301-09	70 mm, Ø 9.0, Fig. 5
86-301-10	75 mm, Ø 10.0, Fig. 6
86-301-11	80 mm, Ø 11.0, Fig. 7
86-301-12	85 mm, Ø 12.0, Fig. 8
86-301-13	90 mm, Ø 13.0, Fig. 9



Chevalier-Jackson Tracheal Tube

Specify with Stainless steel or Struening Ref to S umrray and Phonix Surgical

Catalog #	Size, Profile
86-321-04	45 mm, Ø 4.0, Fig. 0
86-321-05	40 mm, Ø 5.0, Fig. 1?
86-321-06	55 mm, Ø 6.0, Fig. 2
86-321-07	60 mm, Ø 7.0, Fig. 3
86-321-08	65 mm, Ø 8.0, Fig. 4?
86-321-09	70 mm, Ø 9.0, Fig. 5
86-321-10	75 mm, Ø 10.0, Fig. 6
86-321-11	80 mm, Ø 11.0, Fig. 7
86-321-12	85 mm, Ø 12.0, Fig. 8
86-321-13	90 mm, Ø 13.0, Fig. 9



Mark Of Quality



SUNMARK
INSTRUMENTS

Tracheal Tubes
Trachealkanülen
Cánulas traqueales
Canules tracheales
Cannule tracheali

Speaking Tube

Catalog #	Size, Profile
86-351-08	65 mm, Fig. 4
86-351-09	70 mm, Fig. 5
86-351-10	75 mm, Fig. 6
86-351-11	80 mm, Fig. 7
86-351-12	85 mm, Fig. 8
86-351-13	90 mm, Fig. 9



INCHES
MILLIMETERS



General Terms and Conditions of Sales

1. Definitions

“**Company**” means SunMark Instruments Ltd (registered in the United Kingdom under number 7035724).

“**Contract**” means the Order accepted by the Company and incorporating these conditions.

“**Customer**” means the company, firm or organisation who’s Order for the Goods is accepted by the Company.

“**Goods**” means the goods which the Company agrees to supply in accordance with these conditions and which are identified on the Order. “**Order**” means the order for the purchase of the Goods submitted by the Customer.

“**Goods**” means the goods agreed to be provided to the customs by SunMark Instrument.

“**Quotation**” means the quotation by SunMark Instruments stating the price at which and the time period during which it will supply the goods to the customer.

1. Any reference to a law is a reference to it as in force for the time being taking account of any amendment, extension, application or re-enactment and includes any subordinate legislation for the time being in force made under it.
2. Where a condition provides for a list of items following the word “including” or “includes”, then such list is not to be interpreted as being an exhaustive list.

2. General

2.1 Headings are purely for the ease of reference and do not form part of effect the interpretation of Conditions.

2.2 In the event of a conflict the contractual documents shall be applied in the following order:

- a) the Quotation
- b) the Conditions

2.3 No other terms and conditions or warranted are to be incorporated into the Contract unless agreed expressly in writing with SunMark Instruments. In particular, the Customer’s terms and conditions are expressly excluded whether provided in full, referred to in other documents and whether before or after the Contract is formed.

2.4 SunMark Instruments may update or amend these Conditions from time to time to comply with the law or to meet the changing business requirements without notice to the customer.

3. Ordering

3.1 Each Order (whether submitted by telephone, fax, post, email or electronic ordering system) shall be deemed to be an offer by the Customer to purchase the Goods pursuant to these conditions. The Company may, at its complete discretion, refuse to accept any Order. The Contract will be formed upon confirmation of acceptance of the Customer’s purchase order by Surtex Instruments.

3.2 The Customer shall be responsible to the Company for ensuring the accuracy of the terms of any Order (including the description of the Goods ordered).

Samples and Free of Charge Goods

3.3 For the avoidance of doubt, where no order is placed and the Company provides Samples, to familiarize the Customer with the goods, as part of a sampling program or where the Company provides Free of Charge Goods to the Customer as part of a clinical trial or compassionate use program these conditions shall, to the extent applicable, apply to such Samples and Free of Charge Goods.

4. Prices

4.1 The price is exclusive of VAT and all other applicable taxes and duties, which the Customer shall be additionally liable to pay the SunMark Instruments.

4.2 All prices quoted are subject to change up to the date of delivery, subject to prior written notice by SunMark Instruments.

4.3 Surtex Instruments reserves the right, by giving notice to the Customer at any time before delivery, to increase the price of the Goods to reflect any increase in the cost of Surtex Instruments which is due to any factor beyond the reasonable control of SunMark Instruments.

4.4 Errors on SunMark Instruments website prices and availability of products and services are subject to change without notice errors will be corrected where discovered, and SunMark Instruments reserves the right to revoke any stated offer and to correct any errors, inaccuracies or omissions including after an order has been submitted and whether or not the order has been confirmed and your credit card charged. SunMark Instruments shall have the right to refuse or cancel any orders placed for product listed at the incorrect price. SunMark Instruments shall have the right to refuse or cancel any such orders whether or not the order has been confirmed and your credit card charged. If your credit card has already been charged for the purchase and your order is cancelled, Surtex Instruments will issue a credit to your credit card account in the amount of the charge. Individual bank policies will dictate when this amount is credited to your account. If you are not fully satisfied with your purchase, you may return it in accordance with SunMark Instruments’ Return Policy.

5. Delivery

5.1 Delivery of the Goods shall be made to the delivery address specified as stated on the Pro Forma Invoice or communicated separately whichever is greater after the date of the Surtex Instruments acceptance of the Order.

5.2 SunMark Instruments reserves the right to withhold delivery of any Goods if any sum due under any contract with the Customer is overdue or if, in the reasonable opinion of SunMark Instruments, the financial standing of the Customer has been impaired for any other reason.

5.3 Time for delivery shall not be of the essence and, SunMark Instruments shall not be liable for any loss or damage whatever due to any failure by the SunMark Instruments to deliver the Goods (or any of them) promptly or at all. The customer will have no right damages or to cancel the order for any failure to meet the delivery times stated.

5.4 The delivery of the Goods may happen by separate instalments. Each separate instalment shall be invoiced and paid for in accordance with the provisions of the Contract. Each instalment shall be a separate Contract and no cancellation or termination of any one Contract relating to an instalment shall entitle the Customer to repudiate or cancel any other Contractor instalment.

5.5 The Customer shall take delivery of the Goods promptly whenever they are tendered for delivery (which shall include signing the relevant delivery note) If, for any reason, the Customer fails to take such delivery of the Goods or otherwise causes or requests a delay in delivery:

- a) The Goods shall be deemed to have been delivered;
- b) Risk in the Goods shall pass to the Customer, and
- c) SunMark Instruments shall be entitled to store or arrange for the storage of the Goods until actual delivery and charge the Customer for the reasonable costs (including insurance) of such storage and any additional charges incurred in delivering the Goods at a later date.

5.6 The Customer shall ensure that adequate and safe facilities and procedures exist at the Customer’s premises for the delivery of the Goods.

5.7 The Customer shall immediately notify Surtex Instruments Customer Support Centre if the Goods are not received within 10 days of the specified delivery date.

5.8 The customer outside of the UK shall be solely responsible for obtaining all import authorisations.

6. Title and Risk

6.1 The Goods shall be at the Customer’s risk at the time of delivery unless the parties have agreed in writing that the Goods are to be collected from the SunMark Instruments premises, in which case, the Goods shall be at the Customer’s risk when Surtex Instruments notifies the Customer that the Goods are available for collection.

1. Property in the Goods shall not pass from SunMark Instruments until:

- a) The Customer has paid the price in full; and
- b) No other sums whatsoever are due from the Customer to SunMark Instruments.



2. Until property in the Goods passes to the Customer in accordance with the condition 6.1, the Customer shall:
 - a) Hold the Goods on a fiduciary basis as bailed for Surtex Instruments
 - b) Store the Goods separately from all other goods in its possession and mark them in such a way that they are clearly identified as Surtex Instrument's property; and
 - c) Maintain the Goods in satisfactory condition and keep them insured on SunMark Instrument's behalf for their full price.
3. The Customer may sell at full market value or use the Goods only in the ordinary course of the Customer's business. Any such sale or dealing shall be a sale or use of SunMark Instrument's property on the Customer's own behalf and the Customer shall deal as principal when making such sales or dealings. Until property in the Goods passes from SunMark Instruments, the proceeds of sale or otherwise of the Goods, to the full extent of the price of the Goods, shall be held in trust for SunMark Instruments and shall not be mixed with other money or paid into any overdrawn bank account and shall be at all material times identified as Surtex Instruments money.
4. SunMark Instruments shall be entitled to recover the price notwithstanding that property in any of the Goods has not passed from SunMark Instruments.
5. Until such time as the property in the Goods passes from SunMark Instruments, if the Customer: a) Enters into liquidation or has a winding-up order made against it or has an administrator, receiver or manager appointed in respect of its assets; or b) Fails to make payment in accordance with these conditions, the Customer shall upon request deliver up SunMark Instruments such of the Goods as have not ceased to be in existence or resold. If the Customer fails to do so, SunMark Instruments may enter upon any premises owned, occupied or controlled by the Customer where the Goods are situated and repossess the Goods.
6. The Customer shall not pledge or in any way charge by way of security for any indebtedness, any of the Goods which are the property SunMark Instruments. If the Customer does so, all sums whatever owing by the Customer to SunMark Instruments shall forthwith become due and payable.
7. On termination of the Contract, howsoever caused, SunMark Instruments rights contained in this condition 6 shall remain in effect.

7. Terms of Payment

- 7.1 Payment is due to SunMark Instruments within 30 days of invoice (the "Due Date"). In the case of payment other than by cash, payment shall only be deemed to have been made on receipt of cleared funds.
- 7.2 Each consignment or partial delivery shall be invoiced and paid separately.
- 7.3 No disputes arising under the contract no delays in the delivery period beyond the control of SunMark Instruments shall interfere with prompt payment in full by Customer. The Customer shall not in any circumstances or for any reason whatsoever be entitled to make any deduction or withhold any sum from the price by way of set-off or otherwise.
- 7.4 If the Customer fails to make the payment on the due date, then SunMark Instruments without prejudice to other rights and remedies shall be entitled to charge the Customer interest (both before and after judgment) on the amount unpaid at the rate of 4% per annum above the basic rate of HSBC plc during the delay and suspend all further deliveries without notice.
- 7.5 All payments payable to the Company under the Contract shall become due immediately on its termination, despite any other provision.

8. Warranties

- 8.1 SunMark Instruments will use reasonable endeavours to ensure that the Goods
 - a) Correspond to their description and any applicable specification;
 - b) Be of satisfactory quality and fit for purpose held out by Surtex Instruments or made to known to the customer by Surtex Instruments
 - c) Where applicable, be free from defects in design, materials and workmanship and remain so for a period of 12 months after delivery; and
 - d) Comply with all applicable statutory and regulatory requirements relating to the manufacture, labelling, packaging, storage, handling and delivery of Goods
- 8.3 In case of Goods not manufactured by SunMark Instruments
 - a) SunMark Instruments gives no assurance or warranty whatsoever that the sale or use of the Goods will not infringe the patent design right registered, design copyright or other industrial property rights of other person firm or Company and
 - b) The warranty given to the Customer shall be limited to the warranty (if any) which SunMark Instruments receives from the manufacturer or supplier of the Goods to SunMark Instruments.

9. Missing and Defective Goods

- 9.1 The Customer must inspect the Goods immediately on arrival at their premises.
- 9.2 In case of missing goods or defects apparent on inspection:
 - a) a written complaint must be made to SunMark Instruments by the customer within seven days of receipt of the Goods specifying the shortage and/or defect and
 - b) SunMark Instruments shall be given an opportunity to inspect the Goods and investigate any complaint before any use is made of the Goods.
- 9.3 In the case of defects not apparent on inspection:
 - a) the Customer shall send a written complaint to SunMark Instruments as soon as reasonably practicable after the defect is noticed and ensure no use is made of or alterations made to the Goods thereafter;
 - b) the Customer shall allow SunMark Instruments 30 days to inspect the Goods and shall take such steps as are necessary to enable SunMark Instruments to do so including returning of the Goods to its head office in the United Kingdom if requested.
- 9.4 In any potential case of a product being defective pursuant to Part 1 of the Consumer Protection Act 1987, the customer must send the complaint within 12 months of the date of delivery by SunMark Instruments or in the case of items not manufactured by Surtex Instruments, within the guarantee period specified by the manufacturer of such item.
- 9.5 Any complaints made outside of the periods specified in clause 9 will not be considered.
- 9.6 All allegations of total non-delivery of any consignment of the Goods must be made by notice in writing by the customer to Surtex Instruments within 10 days of the specified delivery date. Failure by the Customer to give such notice shall render the Customer liable for any temporary or permanent loss of the Goods and all additional costs and expenses incurred by SunMark Instruments in relation to such loss.

10. Liability

- 10.1 Save where Goods manufactured by Surtex Instruments are held to be defective as defined in Part 1 of the Consumer Protection Act 1987, Surtex Instruments sole obligation in the event of any missing or defective Goods, shall be to repair or replace the Goods.
- 10.2 Surtex Instruments shall not be liable in respect of consequential loss, loss of profits, damage to the property, loss of goodwill, loss of business opportunity, wasted expenditure, cost of mitigation arising out of or occasioned by any fault or defect in the Goods supplied or any other losses howsoever caused.
- 10.3 The maximum total liability under or arising out of in connection with this Agreement will not exceed the total of the Contract value.
- 10.4 Nothing in this Agreement shall exclude or limit either party's liability for death or personal injury resulting from negligence or their fraudulent acts, omissions or statements or for infringement of third party's intellectual property rights.
- 10.5 For the purpose of the Health and Safety at Work Act 1974, SunMark Instruments relies upon the testing examination and research carried out by the suppliers to it of propriety equipment and component parts of Goods.
- 10.6 This clause 10 shall survive the termination of the contract.

11. Return of Goods

- 11.1 In cases where Goods are not defective and the customer requests to return the Goods, SunMark Instruments shall be under no contractual obligation to accept the return except in the event of any error on its parts as to the amount or type of Goods delivered.





- 11.2 Any requests to return must be made to SunMark Customer Support Centre within ten working days of the date of actual delivery.
- 11.3 The return of Goods to correct an error in delivery or ordering will only be considered if the Customer Care Team is notified immediately or in any event within 48 hours of delivery to the Customer. Goods must be returned to SunMark Instruments within 5 days of delivery to the customer to correct an error in delivery or ordering.
- 11.4 For the avoidance of doubt, unless defective, the returns of Goods as detailed in sections 11.2, 11.4, 11.5 and 11.6 must be unused, undamaged and in the original packaging. The Goods must be the same batch as originally supplied by Surtex Instruments and are not falsified/counterfeit. All goods are individually assessed by Surtex Instruments before being authorised to return.
- 11.5 Return of Goods for any reason shall require prior consent from SunMark Instruments which shall be sent solely at the discretion of SunMark Instruments. To obtain consent, the Customer Care Team must be notified. Consideration to requests for a return may be given if:
- a) of a bona fide nature;
 - b) made within 10 working days of the actual delivery; and
 - c) unless defective, the Goods must be unused, undamaged and in the original undamaged packaging. The Goods must be the same batch as originally supplied by SunMark Instruments and not falsified/counterfeit.
- 11.6 On the customer contacting SunMark Instruments to request a return, the Customer will be issued with a returns merchandise authorisation number by SunMark Instruments. Goods returned without the prior written approval of SunMark Instruments may be returned to the customer or disposed of at the absolute discretion of the company.
- 11.7 Goods returned will be subjected to the following charges:
- a) for palletised items there will be a standard charge of £75.00 per pallet for any return uplifted by SunMark Instruments.
 - b) for returns of small parcel there will be a minimum £15.00 charge per parcel and a 30% re-stocking charge.
 - c) the event of return resulting from an error on the part of SunMark Instruments in relation to the amount or type of Goods delivered, no charges under this clause 11.7 will apply.
- 11.8 In the event, that any Goods are subject to be called by SunMark Instruments for the purpose of recall, the customer shall provide to SunMark Instruments as much information as it is reasonably possible regarding the whereabouts of the Goods.

12. Cancellation Policy

- 12.1 In the event of cancellation before delivery and if returned after delivery where products are not defective, there will be a re-stocking charge of not less than 30% of the invoice value charged by SunMark Instruments.
- 12.2 Cancellation of an order will only be agreed by SunMark Instruments at its sole discretion, on condition that all costs and expenses incurred by SunMark Instruments up to the time of cancellation and loss of profits and other loss or damage resulting to Surtex Instruments of such cancellation will be reimbursed by the Customer to Surtex Instruments forthwith.

13. Specifications

Surtex Instruments reserve the right to alter or change the specification and dimension of the Goods supplied with reasonable limits having regard to the nature of the Goods. These do not materially affect the quality or fitness for purpose of Goods. Dimensions specified by Surtex Instruments are to be treated as an approximate only unless the Customer specifically states in writing that exact dimensions are required. Our website and catalogues display the product images as accurately as possible, However, Surtex Instruments cannot guarantee the finish/colour you see matches the actual product as the display of the finish and or colour depends in part, upon your monitor and its settings.

14. Marking and Instructions

- 14.1 No name, mark, numbering, colouring, appearance or log on the goods will be obscured, removed or concealed by the Customer.
- 14.2 The Customer will not repackage or alter the presentation of Goods and it will not assist, cause, or enable any other party to do any of the said acts or deal in Goods or packaging which have been subject to such acts.
- 14.3 The Customer acknowledges that it is under a duty to pass on to its customers (where appropriate) all instructions, information and warnings supplied by SunMark Instruments with the Goods.

15. Confidential Information

- 15.1 A party shall treat the Contract as private and confidential and neither party shall publish or disclose any particulars without the prior written consent of the other with the exceptions of 15.2 below.
- 15.2 The obligations expressed in 15.1 above shall not apply to any information which:
- a) Is or subsequently comes into the public domain other than by breach of this clause;
 - b) The disclosure of which is required to be disclosed by law, any governmental or regulatory authority or by a court of competent jurisdiction;
 - c) Comes into the possession of one of the parties prior to its disclosure by the other, or which is acquired lawfully and in good faith from an independent third party.
- 15.3 On the conclusion or termination of the Contract, both parties shall destroy all copies of confidential information obtained from the other and the obligation relating to the confidentiality shall continue for a period of 10 years.
- 15.4 The Customer shall not, without the prior written consent of SunMark Instruments, advertise or make known to any third that SunMark Instruments provided Goods to the Customer.

16. Insolvency

- 16.1 Without limiting its other rights or remedies, SunMark Instruments shall be entitled to cancel the contract, in whole or in part, by notice in writing if:
- a) The Customer makes a voluntary arrangement with its creditors or (being an individual firm) becomes bankrupt or (being a company) becomes subject to an administration order or goes into liquidation (otherwise than for purpose of amalgamation or reconstruction);
 - b) An encumbrancer takes possession, or a receiver is appointed, of any of the property or assets of the Customer.
 - c) The Customer ceases, or threatens to cease, to carry on business; d) SunMark Instruments reasonably apprehends that any of the events mentioned above is about to occur in relation to the Customer and notifies the Customer accordingly.

17. Sub-Contractors

- 17.1 Surtex Instruments may assign the Contractor any part of it to any company, firm or organization.
- 17.2 The Customer shall not be entitled to assign the Contractor any part of it without the prior written consent of SunMark Instruments (such consent not to be unreasonably withheld or delayed).

18. Force Majeure

- 18.1 Surtex Instruments shall not be responsible for any failure to fulfil its obligations under these conditions and/or in relation to the Goods if such failure is caused by an event which is beyond its reasonable control including acts of God, war, armed conflict, acts of terrorism, riot, strikes, industrial action (including action involving Surtex Instruments employees), fire, flood, any natural disaster, any defaults by Surtex Instruments suppliers or subcontractors, difficulties obtaining workmen or materials, and breakdown of machinery.
- 18.2 If such event continues for more than one month, SunMark Instruments may terminate the Contract without liability.



19. Waiver

19.1 waiver of any right or remedy under the contract or law is only effective if given in writing and shall not be deemed a waiver of any subsequent breach or default. No failure or delay by a party to exercise any right or remedy provided under the Contract or by law shall constitute a waiver of that or any other right or remedy. No single or partial exercise of such right or remedy shall prevent or restrict the further exercise of that or any other right or remedy.

20. Severance

20.1 any provision or part-provision of the Contract is or becomes invalid, illegal or unenforceable, it shall be deemed modified to the minimum extent necessary to make it valid, legal and enforceable whilst retaining the risk and reward between the parties. If such modification is not possible, the relevant provision or part-provision under this clause shall not affect the validity and enforceability of the rest of the Contract.

21. Variation

21.1 as set out in these Conditions, no variation of the Contract, including the introduction for any additional terms and conditions, shall become effective unless it is agreed in writing and signed by SunMark Instruments.

22. General

22.1 rights and remedies of SunMark Instruments set out in these conditions shall be in additions and without prejudice to any other rights and remedies which may be available to SunMark Instruments at common law or under the statute.

23. Governing Law and Jurisdiction

23.1 The contract and any dispute or claim arising out of or in connection with it or its subject matter or formation (including not-contractual disputes or claims) shall be governed by and construed in accordance with the law of England and Wales.

23.2 Each party irrevocably agrees that the courts of England and Wales shall have exclusive jurisdiction to settle any dispute or claim arising out of or in connection with his agreement or its subject matter or formation (including non-contractual disputes or claims).

23.3 The schedules to the Uniform Law of International Sales Act 1967 shall not in any circumstances apply to the contract.

24. Entire Agreement

24.1 This contract constitutes the whole agreement and understanding between the parties in relation to its subject matter and supersedes any previous arrangement, understanding, representations, (including any information or data set out in any sales and marketing literature), or agreement between them relating to the subject matter of this Agreement.

24.2 Each party acknowledges that, in entering into this Agreement, it has not relied on any statement, assurance or warranty (whether made negligently or innocently) other than those expressly set out in this Agreement and has no rights and remedies in respect thereof.

25. Third-Party Rights

25.1 term of this agreement shall be enforceable under the Contracts (Rights of Third Parties) Act 1999 by any legal entity who is not a party to this Agreement.

26. Notices

26.1 communications between the parties about the Contract shall be in writing and delivered by pre-paid first-class post or by hand to the party's registered office, principal place of business or such other address as may at the relevant time have been notified pursuant to this provision to the party giving notice. In the absence of evidence of earlier receipt, any notices shall be deemed to be duly served:

- a) If sent by first class post, two working days after posting; or
- b) If delivered personally, when left at the relevant address.



SUNMARK
INSTRUMENTS

Mark Of Quality



ALPHABETICAL INDEX



Alphabetical Index

A

	Page
Abraham Tonsil Knife	112
Adams Napkin Holder	2
Adson Ear Forcep	37
Aiach Columella Suturing Forcep	106
Andrew Tongue Depressor	9
Asch Septum Straightening Forcep	106
Aufricht	
Glabella Rasp	100
Nasal Retractor	104-105
Austin Attic Dissector	55

B

Ballenger	
Swivel Knife	86
Septum Gouge	91
Ballenger-Hajek Septum Elevator	88
Barbara Micro Ear Pick	50-53
Barnhill Adenoid Curette	108
Barth Ear Scoop	63
Bauer	
Intra Oral Retractor	11-12
Osteotome	22
Beckmann Adenoid Curette	107
Bellucci Micro Scissor	45-46
Beyer Mastoid Rongeur	68
Billeau Ear Loop	64
Bishop Lip & Cheek Retractor	8
Blohmke Tonsil Grasping Forcep	115
Bose Tracheal Retractor,	131
Bruenings	
Tongue Depressor	10
Ethmoid Forcep	80
Tonsil Snare	116
Huber Handle Tube	119
Broncho-Esophagoscopy Forcep Tip	121
Buck Ear Curette	61-62
Buckingham Chisel	57

C

Carpenter	
Tonsil Knife	112
Tonsil Dissector	112
Cawood-Minnesota Cheek Retractor	8

C

	Page
Chevalier-Jackson	
Forcep	126-127
Tracheal Tube	134
Cinelli Osteotome	95
Citelli Mastoid Rongeur	68
Coakley Antrum Curette	107
Collin Tongue Holding Forcep	10
Colver Tonsil Grasping Forcep	115
Converse Nasal Retractor	104
Cordes Broncho-Esophagoscopy Forcep Tip	122
Corwin Tonsil Haemostat	118
Cottle	
Nasal Speculum	74-75
Rhinoplasty Knife	85
Septum/Periosteal Elevator	88-90
Osteotome/Chisel	92-93
Chisel	96
Cartilage Crusher	98
Nasal Rasp	100
Alar Hook/Retractor	104-105
Skin Grasping Forcep	106
Cottle-Neivert Alar Hook	103
Cottle-Walsham Septum Straightening Forcep	105
Craig Septum Forcep	
Craig-Dominick Ethmoid Forcep	79

D

Dautrey-Munro Osteotome	23
Davis-Boyle Mouth Gag	5
Denhart Mouth Gag	3
Dingmann	
Mouth Gag	6-7
Zygoma Elevator	21
Bone Hook	22
Otobrader	57
Dolwick-Type	
TMJ Disc Clamp	24
TMJ Condylar Retractor	24
TMJ Elevator	24
Draffin Bipod	7
Dunn-Dautrey	
Osteotome	23
Elevator	24
Denis-Browne Tonsil Holding Forcep	115



Alphabetical Index

E

	Page
Ear Syringe	68-69
Eicken-Killian Irrigation Tube	109
Epker-Bauer Osteotome	22
Eves Tonsil Snare	116

F

Farrior Ear Speculum	31
Faulkner Antrum Curette	107
Fergusson-Ackland Mouth Gag	3
Fisch Micro Dissector	55
Fischer Tonsil Knife	112
Fomon	
Rhinoplasty Knife	85
Chisel	94
Bone File	99
Nasal Rasp	102-103
Fraenkel Broncho-Esophagoscopy Forcep Tip	120
Freer	
Mucosa Knife	85
Septum Knife	86
Septum Elevator	87-88
Septum Chisel	90-91
Fuller Introducing Forcep	48

G

Gallaher Antrum Rasp	100
Gillies Zygoma Elevator	21
Gross Ear Scoop/Hook	63
Gruenwald	
Ear Forcep	37-38
Nasal Tampon Forcep	76
Gwynne-Evans Tonsil Elevator	113

H

Hajek	
Sphenoid Punch	84
Hajek-Kofler Sphenoid Punch	84
Halle, Septum Elevator	87
Hargis	
Medial Ramus Retractor	14

H

	Page
Mandibular Body Retractor	15
Anterior Border Stripper	15
Periosteal Elevator	15
Periform Rim Retractor	15
Pterygoid Osteotome	16
Bone Holding Forcep	19
Hartmann	
Tongue Depressor	9
Ear Speculum	28-30
Tuning Fork	32-35
Ear Catheter	36
Ear Polypus Forcep	38
Alligator Forcep	40
Ear Hook	64
Nasal Polypus Forcep	78
Nasal Cutting Forcep	82
Tonsil Punch	118
Hartmann-Halle Nasal Speculum	72-73
Hartmann-Hoffmar Alligator Punch	41
Hartmann-Weingartner Alligator Forcep	41
Hartmann-Wullstein Alligator Forcep	39
Haslinger Tonsil Retractor	114
Heister Mouth Gag	2
Henahan Retractor	11
Henke Tonsil Dissector	113
Heymann Septum Forcep	79
Heymann-Knight Nasal Polypus Forcep	78
Hofer Tonsil Retractor	114
House	
Micro Measuring Rod	56
Micro Ear Curette	57
House-Dieter Malleus Nipper	48
Howarth Periosteal Elevator	90
Huber Universal Handle	119
Hurd Tonsil Dissector	112

I

Iterson Tracheal Hook	132
-----------------------	-----



Alphabetical Index

J

	Page
Jackson Tracheal Hook,	133
Jansen	
Ear Forcep	38
Ear Scoop	63
Nasal Tampon Forcep	76
Jansen-Middelton Septum Forcep	83
Jennings Mouth Gag	3
Joseph,	
Rhinoplasty Knife	84-85
Septum Elevator	87
Periosteal Elevator	90
Nasal Saw	97
Bone File	99
Jurasz Adenoid Cutting Forcep	118

K

Kerrison Sphenoid Punch	84
Killian	
Nasal Speculum	73-74
Nasal Polypus Forcep	78
Septum Elevator	88-89
Septum Gouge	92
Killian-Claus Septum Gouge	92
Kiiner-Doughty Mouth Gag	4-5
Knight Septum Forcep	79
Kocher Goitre Enucleator,	133
Koenig	
Tongue Depressor	10
Tuning Fork	35
Krause	
Polypus Snare	36,75
Broncho-Esophagoscopy Forcep Tip	121
Krause-Voss Polypus Snare	36,75
Kressner Septum Forcep	105

L

Laborde Tracheal Dilator,	131
LaForce Adenotome	108-109
Lahey Goitre Grasping Forcep,	133-134
Lange	
Alar Hook	103
Broncho-Esophagoscopy Forcep Tip	121
Lange-Wilde Polypus Snare	36

L

	Page
Langenbeck	
Finger Protector	2
Ear Curette	61
Lempert	
Ear Scoop	63-64
Periosteal Elevator	67-68
Levasseur-Merrill Intra Oral Retractor	12
Lewis Nasal Rasp	100
Littauer	
Ear Polypus Forcep	38
Nasal Polypus Forcep	78
Love Tonsil Retractor	113
Lubet-Barbon Nasal Polypus Forcep	77
Luc Ethmoid Forcep	79-80
Lucae	
Tuning Fork	34
Ear Forcep	37-38
Ear Hook	65
Tympanum Needle	66-67
Luer	
Tracheal Retractor	132
Tracheal Tube	134
Lukens Thymus Retractor	133
Luniatschek Gauze Packer	114

M

Maltz Nasal Rasp	99, 101
Martin-Simplex Cheek Retractor	8
Masing Periosteal Elevator	90
Maunder Mouth Gag	2
Mayo Tongue Depressor	10
McGee	
Micro Alligator Forcep	41-42
Wire Bending Forcep	47
Micro Ear Needle	52-53
McIvor Mouth Gag	6
McKenty Septum Elevator	87-88
McKesson Mouth Prop	8
Michel Laryngeal Mirror	129
Miller-Colburn Bone File	98
Mini-McGee Micro Alligator Forcep	42
Minnesota Cheek Retractor	9
Mod. Vienna Nasal Speculum	72
Moldnehauser Foreign Body Lever	67
Molt Mouth Gag	3
Museux Tonsil Grasping Forcep	116
Mollison Tonsil Dissector/Retractor	113



Alphabetical Index

N

	Page
Nager Tonsil Retractor	113
Negus	
Chest Support for Mouth Gag	4
Tongue Depressor	7
Neivert Nasal Retractor	105
Neivert-Anderson Osteotome	95
Neuro Tuning Fork	35

O

Obwegeser	
Mouth Gag	2
Lip and Cheek Retractor	8
Soft Tissue Retractor	12-13
Mandibular Retractor	13
Ramus Retractor	13-14
Chin Retractor	14
Channel Retractor	14
Periosteal Elevator	16
J-Stripper	17
Ramus Stripper	17
Awl	19-20
Wire Loop Forcep	20
Septonasal Osteotome	25
Wedge Osteotome	25
Split Osteotome	25
Osteotome	26
Ogura Skin Grasping Forcep	106

P

Parkes	
Osteotome	97
Bone File	100
Pennington Septum Elevator	89
Petri Intra Oral Retractor	11
Pierce Septum Elevator	89
Plester Flap Knife	49
Politzer	
Furuncle Knife	66
Tympanum Needle	66

Q

	Page
Quire Foreign Body Forcep	39

R

Richnau-Holmgren Ear Speculum	31
Ritter-Halle Frontal Sinus Dilator	110
Roeder Tonsil Ligator	114
Roger Periosteal Elevator	89
Rose Tracheal Retractor,	132
Rosen	
Circular Cutting Knife	50
Micro Periosteal Elevator	56
Rosenberg Broncho-Esophagoscopy Forcep Tip	122
Roser-Koenig Mouth Gag	3
Rowe Disimpaction Forcep	21
Rubin	
Septum Forcep	83
Osteotome	94
Russel-Davis Tongue Depressor	7
Rydel-Seiffer Tuning Fork	35

S

Scheinmann Broncho-Esophagoscopy Forcep Tip	120
Schmeden	
Nasal Cutting Forcep	83
Tonsil Punch	118
Schmidt Tonsil Forcep	115
Schoeborn Tracheal Retractor,	132
Schuknecht Rotary Knife	48
Schumacher Broncho-Esophagoscopy Forcep Tip	122
Seeker	65
Seiffert Broncho-Esophagoscopy Forcep Tip	120
Sexton Myringotomy Knife	49
Shambaugh Micro Ear Needle	54-55
Shapleigh Ear Curette	61
Shea	
Micro Scissor	47
Exploring Hook	55
Micro Ear Curette	57
Sheehan Osteotome	96
Siegle Otoscope	32
Sigmoid Notch Extra Oral Retractor	11
Silver Chisel	96-97
Sluder-Ballenger Tonsillectome	117



Alphabetical Index

S

	Page
Smith	
Ramus Separator	20
Sagittal Split Separator	
Snare Wire	36, 117
Speaking Tube	135
St. Clair Thompson Adenoid Curette	108
Stammberger Nasal Cutting Forcep	82
Steinhauser	
Zygomatic Retractor	14
Repositioning Instrument	17
Struempel Alligator Forcep	41
Struycken Nasal Cutting Forcep	82

T

Tabb Mucosa Knife	49
Takahashi Ethmoid Forcep	80
Tatum Sinus Life Curette	17-19
Terry	
Ramus Pusher	17
Septal Osteotome	25
Thudichum Nasal Speculum	71
Tieck-Halle Nasal Speculum	73
Tilley Ear Polypus Forcep	39
Tobold Tongue Depressor	9
Toynbee Ear Speculum	29
Troeltsch	
Ear Forcep	37
Nasal Tampon Forcep	76
Trousseau Tracheal Dilator	131
Tuning Fork,	33-35
Turvey Palatal Expander	24
Tyding Tonsil Snare	117

U

Uckermann Tracheotomy Trocar	131
------------------------------	-----

V

Voltolini Nasal Speculum	72
--------------------------	----

W

	Page
Wagener Ear Hook	65
Walter Chisel	94
Watson-Williams Ethmoid Forcep	80-81
Weber-Loch Ear Loop	64
Weil-Blakesley Nasal Cutting Forcep	81-82
West	
Septum Chisel	91
Septum Gouge	91
Westmacott Nasal Polypus Forcep	77
White Tonsil Grasping Forcep	114
Whitehead Mouth Gag	4
Wieder Tongue Depressor	9
Wiener Nasal Rasp	101
Wilde Ear Forcep	37
Wullstein	
Micro Scissor	46-47
Sickle Knife	49
Wilson Tonsil Artery Forcep	115

Y

Young Tongue Holding Forcep	11
-----------------------------	----

Z

Zaufal Foreign Body Forcep	67
Zoellner	
Ear Speculum	30
Micro Ear Needle	58-59
Micro Ear Knife	59
Tympanum Needle	60
Raspatory	60
Application Instrument	



SUNMARK
I N S T R U M E N T S

Mark Of Quality

ORAL, MAXILLOFACIAL & ENT INSTRUMENTS CATALOGUE

+92 (331) 661 9646

www.sunmarkinstruments.com

sales@sunmarkinstruments.com

Small Industrial Estate Sialkot-51310 Punjab Pakistan

