



SUNMARK
INSTRUMENTS

Mark Of Quality

Our Range of Best Selling Instruments
GENERAL INSTRUMENTS CATALOGUE

INSTRUCTIONS FOR REPROCESSING OF REUSABLE SURGICAL INSTRUMENTS

The following instructions are for all reusable medical devices supplied by Sunmark Instruments Ltd, unless stated otherwise with the packaging of the product. These instructions are intended for use only by persons with the required specialist knowledge and training.

Warnings

- Follow instructions and warnings as issued by the manufacturers of any decontaminants, disinfectants and cleaning agents. Wherever possible avoid use of mineral acids and harsh, abrasive agents.
- No part of the process shall exceed 140 °C.
- Some sensitive materials (e.g. Aluminium) are damaged by high alkaline solutions (pH>10).
- Devices with long, narrow cannula, hinges and blind holes require particular attention during cleaning.

Note: When reprocessing medical devices, always handle with care, wearing protective clothing, gloves and eye-wear in accordance with local health & safety procedures.

Limitations on Reprocessing

- Repeated processing has minimal effect on these instruments.
- End of life normally determined by wear and damage in use.
- Any specific limitations on the number of reprocessing cycles shall be made available with instrument.

From Point of Use

Whenever possible, do not allow blood, debris or bodily fluids to dry on instruments. For best results and to prolong the life of the medical device reprocess immediately after use. If they cannot be reprocessed immediately, use an enzymatic foam spray cleaner to help prevent soil from drying.

Preparation for Decontamination

- Process all the instruments as soon as it is reasonably practical following use.
- Disassemble only where intended, without the use of tools unless specifically provided by the manufacturer. Instructions for dis assembly are available with the device, where required.

Cleaning: Automated

- Use only either CE marked or validated washer-disinfector machines and low foaming, non-ionizing cleaning agents and detergents following the manufacturer's instructions for use, warnings, concentrations and recommended cycles.
- Load instruments carefully, with any box joints and hinges open and so that any fenestration in instruments can drain.
- Place heavy instruments with care in the bottom of containers, taking care not to overload wash baskets.
- Place instruments with concave surfaces facing down to prevent pooling of water.
- Where possible, use appropriate attachments to flush inside reamers and devices with lumens or cannula.
- Ensure that soft, high purity water which is controlled for bacterial endo-toxins is used in the final rinse stage.

Note: Automated cleaning may not be suitable for all lumens and cannula in which case clean manually with a water jet gun, if available, and an appropriate brush (and stilette if provided) that reaches the depth of the feature. After manually cleaning, pass all devices through an automatic cleaning cycle to achieve disinfection.

Note: These instruments have been validated using a washer-disinfector cycle validated to include two cold rinses at <35 °C, a detergent cycle and a rinse cycle both at >50°C, a disinfection cycle operating at a temperature of between 80 °C and 90 °C for a minimum holding time of 1 minute (actual holding time in excess of 2 minutes 50 seconds) and a 20 minute drying cycle. The detergent used was low foaming, non-ionizing spray wash detergent cleaner (max 12pH) and the rinse aid a neutral pH low foaming, non-ionic surfactant with isopropyl alcohol.

Cleaning: Manual

- Manual cleaning is not advised if an automatic washer-disinfector is available. If the equipment is not available, use the following process:-
1. Use a double sink system (wash/rinse) dedicated for instrument cleaning (not used for hand washing). Ensure that the water temperature does not exceed 35 of the re-processor to ensure that the reprocessing as actually performed using equipment, materials and personnel in the reprocessing facility achieve the desired result. This requires validation and routine monitoring of the process. Likewise any deviation by the re-processor from the instructions provided must be properly evaluated for effectiveness and potential adverse consequences.
 2. In the first sink, keeping the instrument submerged, with an autoclavable brush, apply CE marked cleaning solution to all surfaces until all soil has been removed. Pay particular attention to serrations, teeth, ratchets and hinges, always brushing away from the body and avoiding splashing. Ensure rongeurs and hinged instruments are thoroughly cleaned in both open and closed positions.
 3. In the second sink, rinse instruments thoroughly with soft, high purity water which is controlled for bacterial endotoxins, so that the water reaches all parts of the instrument, then carefully hand dry or use a drying cabinet.

Note: Manual Cleaning is NOT a disinfection process: When manual cleaning is used it may not be possible to disinfect the device prior to further handling.

Cleaning Inspection

- After cleaning visually inspect, visually inspect all surfaces, cannulations, ratchets, joints, holes and lumens for complete removal of soil and fluids. If ANY soil or fluid is still visible, return the instrument for repeat decontamination.

Maintenance

- Apply surgical grade lubricant to hinges, joints and moving parts as per the lubricant manufacturer's instructions.

Continued on next page

Inspection and Functional Testing

- Visually inspect and check: - all instruments for damage and wear; cutting edges are free from nicks and present a continuous edge; jaws and teeth align correctly; all articulated instruments have a smooth movement without excess play; locking mechanisms (such as ratchets) fasten securely and close easily; long, slender instruments are not distorted; any component parts fit and assemble correctly with mating components.
- Remove for repair and replacement any blunt, worn out, flaking, fractured or damaged instruments.

Note: If an instrument is returned to the manufacturer / supplier, the instrument must be decontaminated and sterilized and be accompanied with the relevant documented evidence.

Packaging

- All instruments to be packed following local protocol in accordance with ISO 11607-1 or AAMI/CSR technique.

Sterilization (USA)

- Autoclave should comply with the requirements of, and be validated and maintained in accordance with ANSI/AAMI ST79.
- Pre-Vacuum moist heat sterilization operating at temperature 132 °C bar for a minimum holding time of 4 minutes always following the instructions of the machine manufacturer.
- When sterilizing multiple instruments in one autoclave cycle, ensure that the sterilizer manufacturers stated maximum load is not exceeded.
- Ensure instruments are dry before sterilization.

Sterilization (Outside USA)

- Autoclave should comply with the requirements of, and be validated and maintained in accordance with EN 285, EN 13060, EN ISO 17665.
- Either CE marked or validated vacuum autoclave operating at 134-137 °C bar for a minimum holding time of 3 minutes always following the instructions of the machine manufacturer.
- When sterilizing multiple instruments in one autoclave cycle, ensure that the sterilizer manufacturers stated maximum load is not exceeded.

Storage

- Ensure instruments are dry before storage, and stored in dry, clean conditions at an ambient room temperature.

Additional Information

- Other forms of cleaning (i.e. ultrasonic) and sterilization (i.e. Low temperature steam and Formaldehyde, Ethylene Oxide and Gas Plasma) are available. However, always follow the instructions for use as issued by the manufacturer and always consult with them if in any doubt over the suitability of any process used.
- Cleaning and sterilizing guidelines are available in HTM 2030 and HTM 2010. Contact: The NHS Estates Stationers Office Publications Cent for details at www.tsonline.gov.uk. For further information contact: NHS Estates Information Center, Department of Health, 1 Trevelyan Square, Boar Lane, Leeds, LS1 6AE, UK or visit www.nhsestates.gov.uk.

Note: It is the responsibility of the re-processor to ensure that the reprocessing as actually performed using equipment, materials and personnel in the reprocessing facility achieve the desired result. This requires validation and routine monitoring of the process. Likewise any deviation by the re-processor from the instructions provided must be properly evaluated for effectiveness and potential adverse consequences.

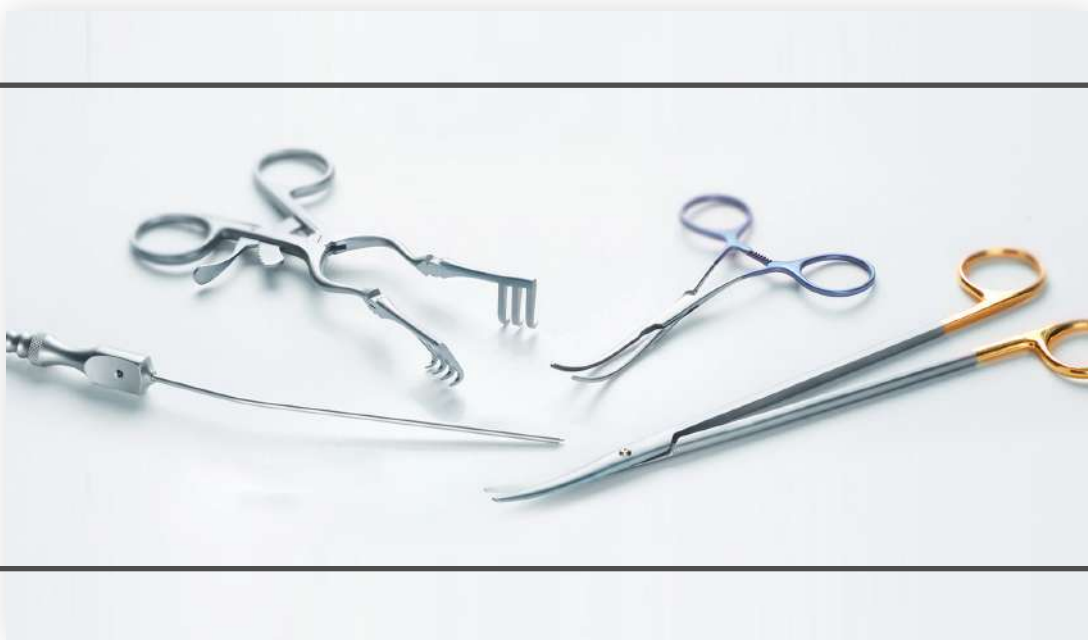

Scalpel Handles
Skalpellgriffe
Mangos de bisturíes
Manches pour bistouris
Manici per bisturi



75-010-03
Scalpel Handle # 3
Solid
Overall Length
12 cm (4 3/4")



75-010-04
Scalpel Handle # 4
Solid
Overall Length
13.5 cm (5 1/4")



75-012-03
Scalpel Handle # 3
Solid, CM Graduation
Overall Length
12 cm (4 3/4")



75-020-13
Scalpel Handle # 3L
Solid, Long
Overall Length
21.5 cm (8 1/2")



75-020-14
Scalpel Handle # 4L
Solid, Long
Overall Length
21 cm (8 1/4")

Scalpel Handles
Skalpgriffe
Mangos de bisturios
Manches pour bistouris
Manici per bisturi



75-021-13
Scalpel Handle # 3L
Solid, Angled, Long
Overall Length 21 cm (8 1/4")

75-021-14
Scalpel Handle # 4L
Solid, Angled, Long
Overall Length 21 cm (8 1/4")

75

SCALPEL, KNIVES



Scalpel Handles
Skalpellgriffe
Mangos de bisturios
Manches pour bistouris
Manici per bisturi



75-030-07
Scalpel Handle # 7
Solid, Also Known as 5
Overall Length 16 cm (6 ¼")



75-030-17
Scalpel Handle # 7K
Solid, Short
Overall Length 12.5 cm (5")



75-032-08
Collin Scalpel Handle # 8
With Hollow Handle
Overall Length 13.5 cm (5 ¼")



75-032-09
Collin Scalpel Handle # 9
With Hollow Handle
Overall Length 14.5 cm (5 ¾")

Scalpel Handles
Skalpgriffe
Mangos de bisturíes
Manches pour bistouris
Manici per bisturi

75

SCALPEL, KNIVES



75-050-03
Scalpel Handle # 3
With Round Hollow Handle
Overall Length 15.5 cm (6")



75-052-03
Scalpel Handle # 3
With Round Handle
Overall Length 14.5 cm (5 ¾")



75-053-03
Scalpel Handle # 3
Solid, Round Handle, Angled
Overall Length 14 cm (5 ½")



75-056-03
Kaye Scalpel Handle # 3
Solid, Round Handle
Overall Length 15 cm (6")



Scalpel Blades
 Skalpellklingen
 Hojas de bisturios
 Lames pour bistouris
 Lame per bisturi

Scalpel Blades
 Pack of 100



75-100-10
 Fig. 10



75-100-11
 Fig. 11

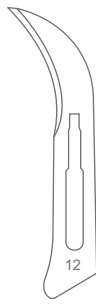

75-100-12
 Fig. 12



75-100-13
 Fig. 13



75-100-15
 Fig. 15

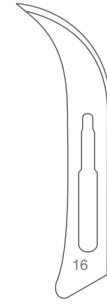

75-100-16
 Fig. 16

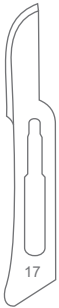

75-100-17
 Fig. 17



75-100-18
 Fig. 18

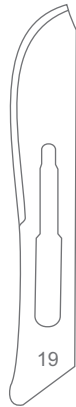

75-100-19
 Fig. 19

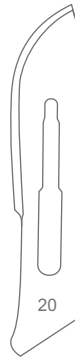

75-100-20
 Fig. 20



75-100-21
 Fig. 21

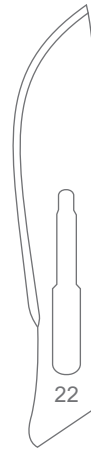

75-100-22
 Fig. 22



75-100-23
 Fig. 23

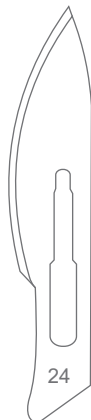

75-100-24
 Fig. 24

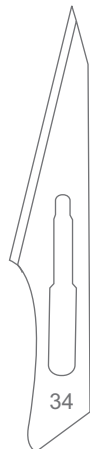

75-100-34
 Fig. 34

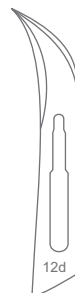

75-101-12
 Fig. 12D



75-101-15
 Fig. 15C

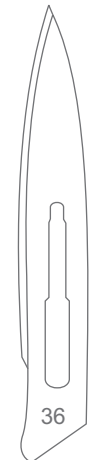

75-100-36
 Fig. 36

Scalpel Handles
Skalpellgriffe
Mangos de bisturíes
Manches pour bistouris
Manici per bisturi

75

SCALPEL, KNIVES



75-204-00
Caspary Scalpel Handle
Overall Length 13.5 cm (5 1/4")



75-206-10
10 cm (4")
75-206-13
13 cm (5")
75-206-15
15 cm (6")

Beaver Scalpel Handle
For Micro Scalpel Blades



75-207-00
Landolt Scalpel Handle
Bayonet Shaped, Round Handle
Overall Length 25 cm (10")



75-209-00
Landolt Scalpel Handle
Bayonet Shaped, Square Handle
Overall Length 21 cm (8 1/4")

Scalpel Blades
Skalpelliingen
Hojas de bisturios
Lames pour bistouris
Lame per bisturi

Scalpel Micro Blades
Pack of 25



75-210-61
Fig. 61



75-210-62
Fig. 62



75-210-63
Fig. 63



75-210-64
Fig. 64



75-210-65
Fig. 65



75-210-66
Fig. 66



75-210-67
Fig. 67

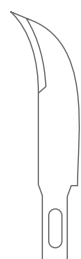

75-210-68
Fig. 68



75-210-69
Fig. 69

Operating Knives
Operating Skalpelle
Bisturios para operaciones
Bistouris pour opérations
Bisturi per interventi

SCALPEL, KNIVES



75-350-01
Bellied Blade
Fig. 1



75-350-03
Bellied Blade
Fig. 3



75-350-04
Bellied Blade
Fig. 4



75-350-06
Bellied Blade
Fig. 6



75-350-07
Bellied Blade
Fig. 7



75-350-08
Bellied Blade
Fig. 8



75-350-09
Bellied Blade
Fig. 9



75-350-14
Sharp Pointed Blade
Fig. 14



75-361-46
Sickle Pointed Blade
Fig. 46

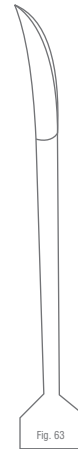

75-361-46
Tenotome
Fig. 63

75-350-01
Operating Knife
Bellied Blade, Fig. 1
Overall Length 14 cm (5 1/2")

Post Mortem Knives
Organmesser
Cuchillos para órganos
Couteaux à autopsie
Coltli per autopsia



75-400-10
Virchow Autopsy Knife
With Wooden Handle, Blade Size 100 mm
Overall Length 25.5 cm (10")



75-402-08
Virchow Cartilage Knife
With Wooden Handle, Blade Size 80 mm
Overall Length 21 cm (8 1/4")



75-410-11
Blade Size 110 mm
26 cm (10 1/4")

75-410-14
Blade Size 140 mm
29 cm (11 1/2")

75-410-17
Blade Size 170 mm
31 cm (12 1/4")

Walb Post Mortem Knife
With Wooden Handle

Amputation Knives
Amputationsmesser
Cuchillos para amputación
Couteaux à amputation
Coltelli per amputazione



75-420-16

Blade Size 160 mm
26 cm (10 1/4")

75-420-20

Blade Size 200 mm
33.5 cm (13 1/4")

75-420-24

Blade Size 240 mm
38 cm (15")

Virchow Brain Knife
With Hollow Handle



75-450-13

Blade Size 130 mm
26 cm (10 1/4")

75-450-16

Blade Size 160 mm
29 cm (11 1/2")

75-450-19

Blade Size 190 mm
32.5 cm (12 3/4")

75-450-22

Blade Size 220 mm
35 cm (13 3/4")

Liston Amputation Knife
With Hollow Handle



Amputation Knives
Amputationsmesser
Cuchillos para amputación
Cou-teaux à amputation
Coltelli per amputazione



75-460-16
Catlin Amputation Knife
With Hollow Handle
Blade Size 160 mm
Overall Length 29 cm (11 1/2")



75-470-12
Langenbeck Flap Knife
Blade Size 120 mm
Overall Length 25 cm (9 3/4")



75-472-10
Phalangeal Knife
Blade Size 150 mm
Overall Length 23.5 cm (9 1/4")



75-474-11
Interosseous Knife
Blade Size 110 mm
Overall Length 24 cm (9 1/2")

Amputation Knives
Amputationsmesser
Cuchillos para amputación
Couteaux à amputation
Coltelli per amputazione

75

SCALPEL, KNIVES



75-480-65

Resection Knife

Solid Handle

Dissecting End, Blade Size 65 mm

Overall Length 19 cm (7 ½")



75-482-55

Langenbeck Resection Knife

Blade Size 55 mm

Overall Length 18 cm (7")



75-484-55

Langenbeck Resection Knife

Blade Size 55 mm

Overall Length 18 cm (7")

Fistula Knives
Fistelmesser
Bisturios para fistulas
Bistouris à fistules
Bisturi per fistole



75-488-01
Simon Fistula Knife
Fig. 1
Overall Length 20 cm (8")



75-488-01
Fig. 1



75-488-02
Fig. 2



75-488-03
Fig. 3



75-490-22
Ulrich Fistula Knife
Overall Length 22.5 cm (9")



75-490-22
Ulrich Fistula Knife
Overall Length 20.5 cm (8")

Tonsil Knives
Tonsillenmesser
Bisturies para amígdalas
Bistouris pour amygdales
Bisturi per tonsille



75-494-23
Trigeminal Knife
Overall Length 23 cm (9")



75-501-20
Fowler Tonsil Knife
Overall Length 20 cm (8")



75-503-21
Abraham Tonsil Knife
Overall Length 21 cm (8 1/4")



75-505-13
Masing Cartilage Slitting Knife
Overall Length 13 cm (5")



Dermatomes
Dermatome
Dermátoms
Dermatomes
Dermatomi

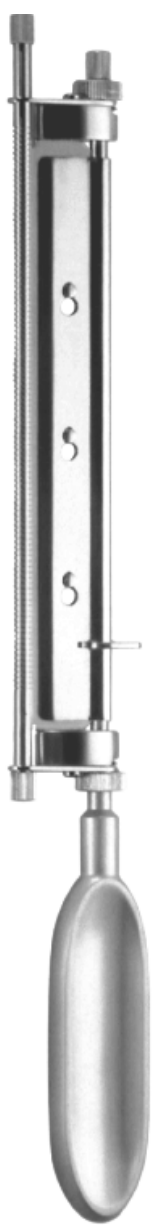

75-700-32
Humby Skin Graft Knife (Dermatome)
Thickness Adjustable From 0.1 to 1.2 mm
Cutting Width Maximum 155 mm
Overall Length 32 cm (13")

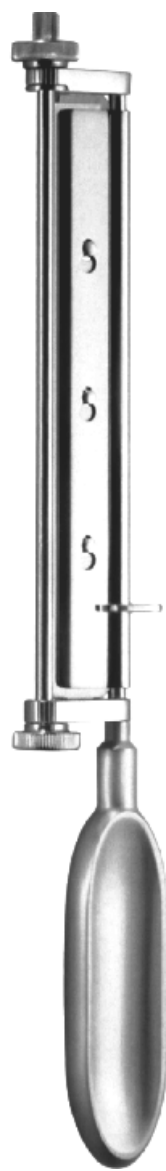

75-710-30
Watson Skin Graft Knife (Dermatome)
Thickness Adjustable From 0.1 to 1.2 mm
Cutting Width Maximum 155 mm
Overall Length 30.5 cm (12")



75-712-00
Skin Graft Knife Blade (Dermatome Blade)
For 75-700-32 and 75-710-30
Overall Length 15 cm (6")

Dermatomes
Dermatome
Dermátoms
Dermatomes
Dermatomi

75

SCALPEL, KNIVES

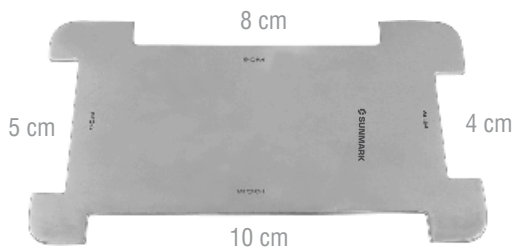

75-734-00

Skin Fixation Plate

4 cm, 5 cm, 8 cm, 10 cm



75-740-19

Silver Skin Graft Knife (Dermatome)

Thickness Adjustable From 0.1 to 1.2 mm, Cutting Width
Maximum 40 mm
Overall Length 19 cm (7 1/2")

Aorta Punches
Aortastanzen
Perforadores aórticos
Rongeurs pour aorte
Pinze taglienti per aorta

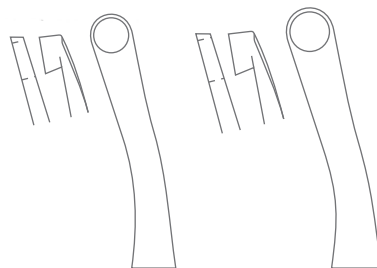
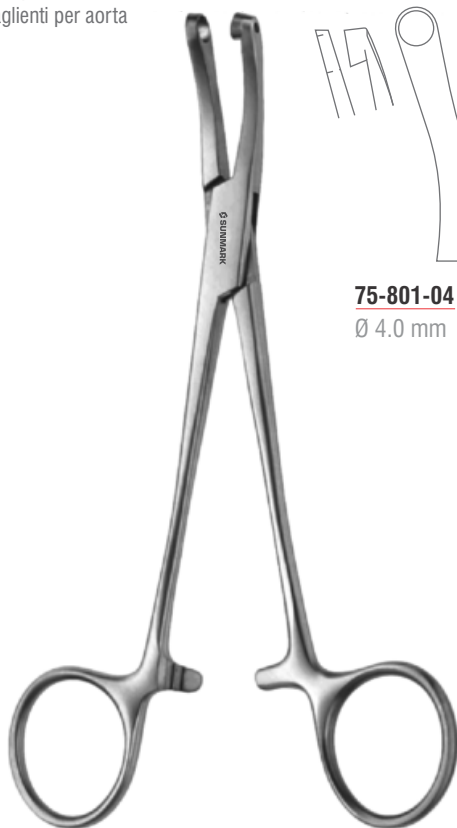

75-801-04
Ø 4.0 mm

75-801-05
Ø 5.0 mm

Karp Aorta Punch
Overall Length 16 cm (6 1/4")



75-804-28
Ø 2.8 mm

75-804-40
Ø 4.0 mm

75-804-45
Ø 4.5 mm

75-804-50
Ø 5.0 mm

75-804-60
Ø 6.0 mm

Aorta Punch
Overall Length 14 cm (5 1/2")

Blade Holders / Blade Breakers
Klingenhalter / Kingenbrecher
Porta-hojas / Rompe-hojas de afeitar
Pincettes pour saisir et casser les lames de rasoir
Pinze per afferrare e rompere le lamette de rasoio

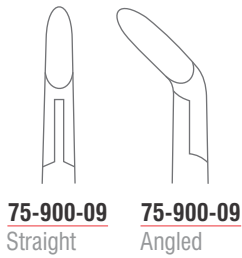

75-900-09
Straight

75-900-09
Angled

75-900-09
Troutman-Chris Blade Holder/Breaker
Round Handle, Straight
Overall Length 9 cm (3 1/2")



75-900-09
Barraquer Blade Holder/Breaker
Overall Length 11 cm (4 1/4")



75-900-09
Castroviejo Blade Holder/Breaker
Round Handle
Overall Length 13 cm (5")

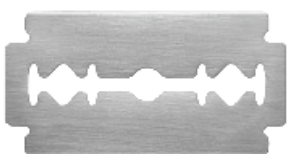

75-900-09
Silver Skin Graft Knife Blade
Pack of 10
Standard

Operating Scissors
Chirurgische Scheren
Tijeras quirúrgicas
Ciseaux chirurgicaux
Forbici per chirurgia



Operating Scissors
Straight, Blunt/Blunt

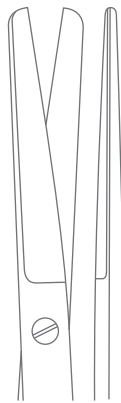

77-002-11
12 cm (4 3/4")

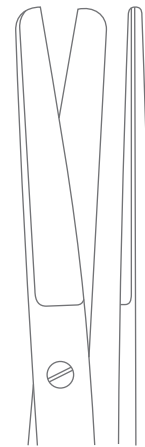

77-002-13
13 cm (5")

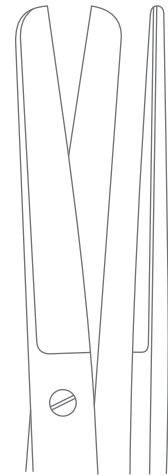

77-002-14
14.5 cm (5 3/4")

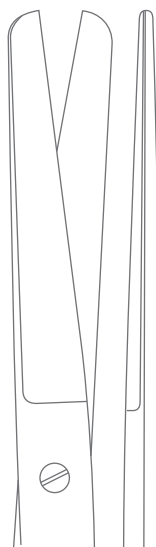

77-002-16
16.5 cm (6 1/2")

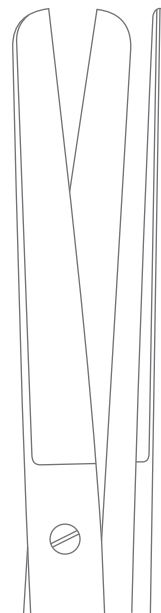

77-002-18
18.5 cm (7 1/4")

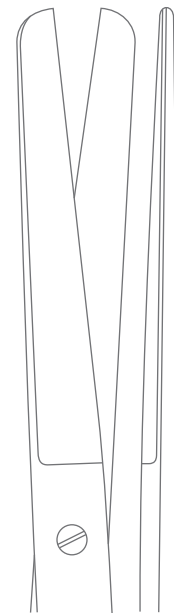

77-002-20
20.5 cm (8")

Operating Scissors
Chirurgische Scheren
Tijeras quirúrgicas
Ciseaux chirurgicaux
Forbici per chirurgia

77

SCISSORS

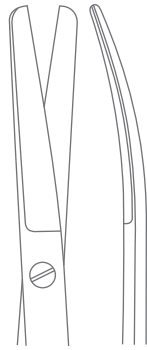

77-003-11
12 cm (4 ¾")

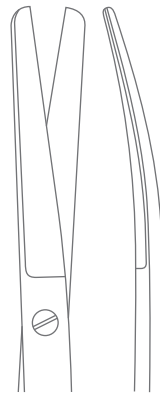

77-003-13
13 cm (5")

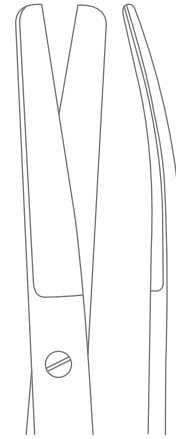

77-003-14
14.5 cm (5 ¾")



77-003-16
16.5 cm (6 ½")



77-003-18
18.5 cm (7 ¼")



77-003-20
20.5 cm (8")

Operating Scissors
Curved, Blunt/Blunt

Operating Scissors
Chirurgische Scheren
Tijeras quirúrgicas
Ciseaux chirurgicaux
Forbici per chirurgia



Operating Scissors
Straight, Sharp/Blunt

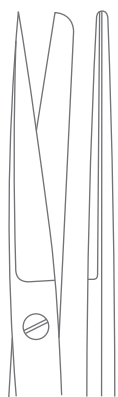

77-004-11
12 cm (4 3/4")

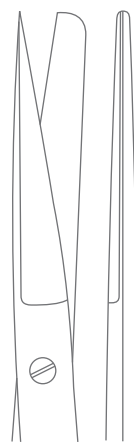

77-004-13
13 cm (5")

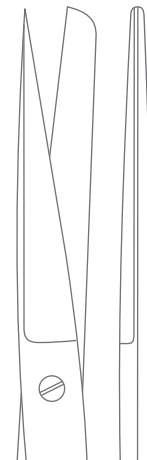

77-004-14
14.5 cm (5 3/4")

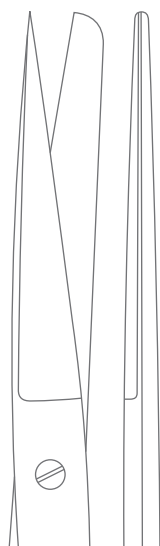

77-004-16
16.5 cm (6 1/2")

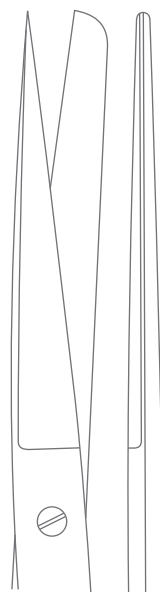

77-004-18
18.5 cm (7 1/4")

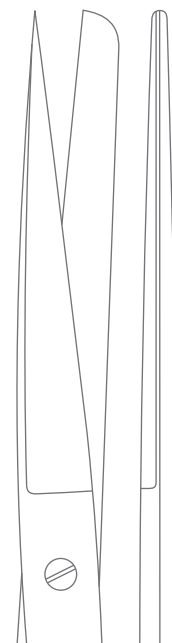

77-004-20
20.5 cm (8")

Operating Scissors
Chirurgische Scheren
Tijeras quirúrgicas
Ciseaux chirurgicaux
Forbici per chirurgia

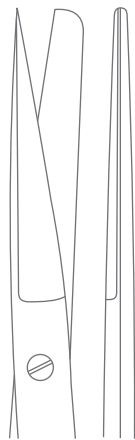

77-004-13 SC
13 cm (5")

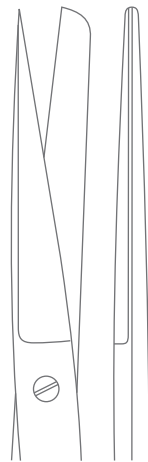

77-004-14 SC
14.5 cm (5 3/4")

Operating Scissors
Straight, Sharp/Blunt

SUPEREdge™

Operating Scissors
Chirurgische Scheren
Tijeras quirúrgicas
Ciseaux chirurgicaux
Forbici per chirurgia



Operating Scissors
Curved, Sharp/Blunt

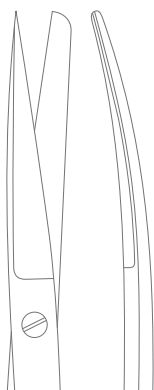

77-005-11
12 cm (4 3/4")

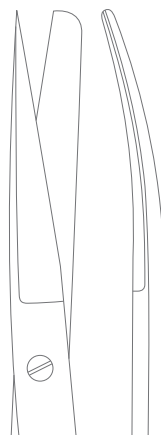

77-005-13
13 cm (5")



77-005-14
14.5 cm (5 3/4")

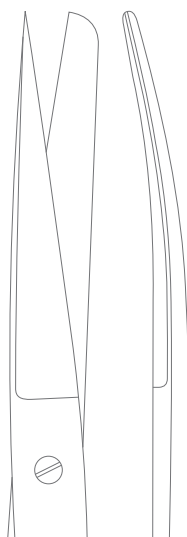

77-005-16
16.5 cm (6 1/2")

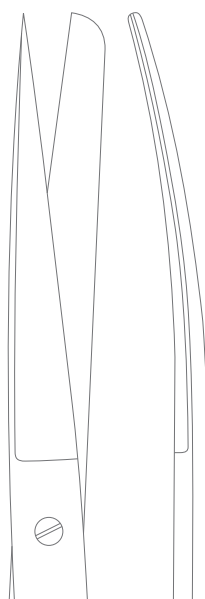

77-005-18
18.5 cm (7 1/4")

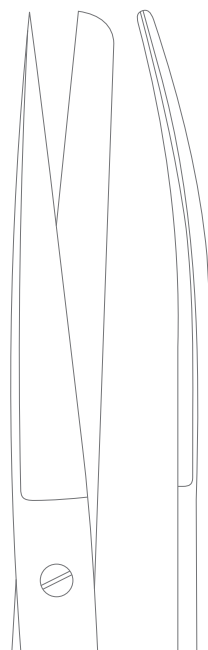

77-005-20
20.5 cm (8")

Operating Scissors
Chirurgische Scheren
Tijeras quirúrgicas
Ciseaux chirurgicaux
Forbici per chirurgia

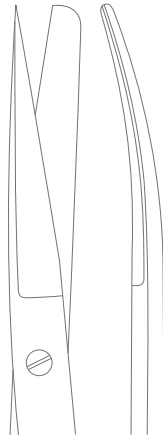

77-005-13 SC
13 cm (5")



77-005-14 SC
14.5 cm (5 3/4")

Operating Scissors
Curved, Sharp/Blunt

SUPEREdge™



Operating Scissors
Chirurgische Scheren
Tijeras quirúrgicas
Ciseaux chirurgicaux
Forbici per chirurgia



Operating Scissors
Straight, Sharp/Sharp

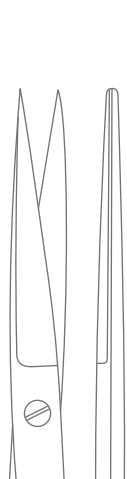

77-006-11
12 cm (4 ¾")

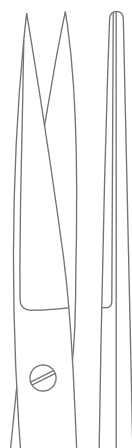

77-006-13
13 cm (5")

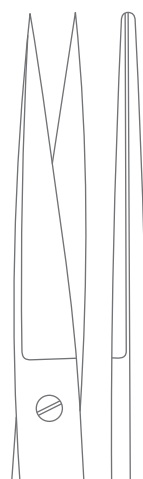

77-006-14
14.5 cm (5 ¾")

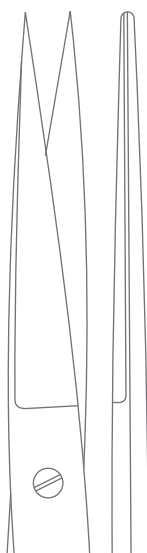

77-006-16
16.5 cm (6 ½")

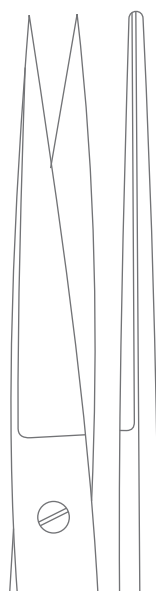

77-006-18
18.5 cm (7 ¼")

Operating Scissors
Chirurgische Scheren
Tijeras quirúrgicas
Ciseaux chirurgicaux
Forbici per chirurgia



Operating Scissors
Curved, Sharp/Sharp

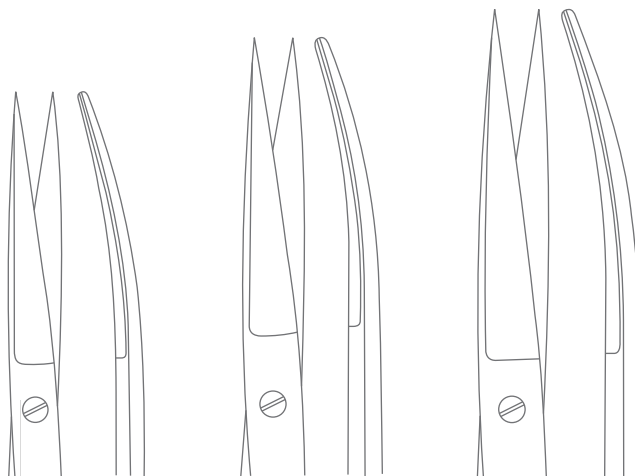

77-007-11
12 cm (4 ¾")

77-007-13
13 cm (5")

77-007-14
14.5 cm (5 ¾")

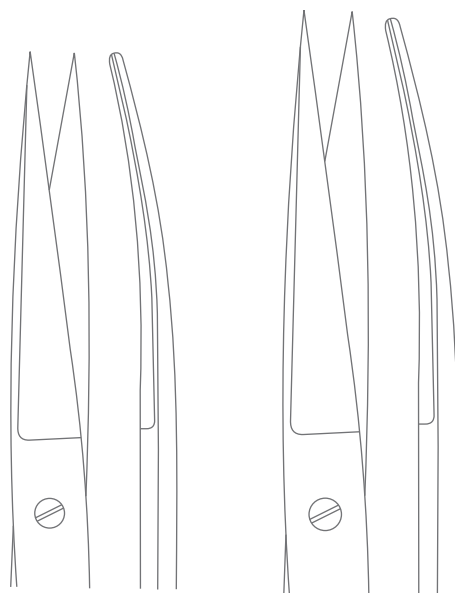

77-007-16
16.5 cm (6 ½")

77-007-18
18.5 cm (7 ¼")

Operating Scissors
Chirurgische Scheren
Tijeras quirúrgicas
Ciseaux chirurgicaux
Forbici per chirurgia

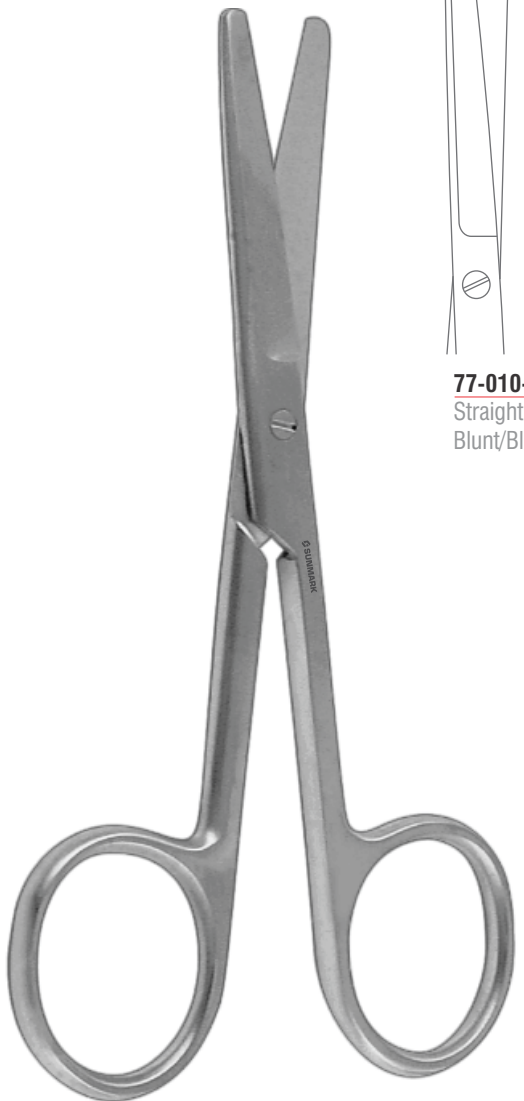

Operating Scissors
Slender Pattern Blunt/Blunt
Overall Length 14.5 cm (5 3/4")

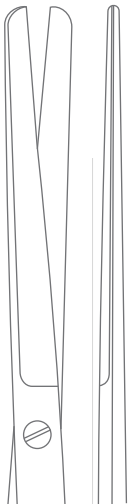

77-010-14
Straight
Blunt/Blunt



77-011-14
Curved
Blunt/Blunt

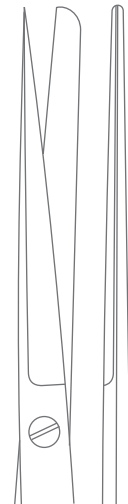

77-012-14
Straight
Sharp/Blunt



77-013-14
Curved
Sharp/Blunt

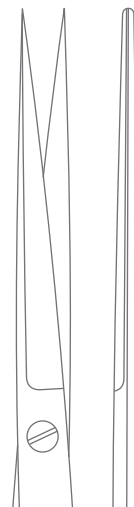

77-014-14
Straight
Sharp/Sharp



77-015-14
Curved
Sharp/Sharp

Operating Scissors
Chirurgische Scheren
Tijeras quirúrgicas
Ciseaux chirurgicaux
Forbici per chirurgia



77-018-13
Incision Scissors
Straight

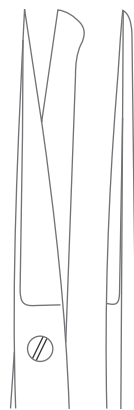

77-018-13
13 cm (5")

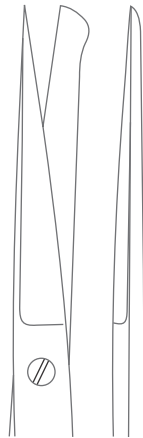

77-018-13
14.5 cm (5 ¾")

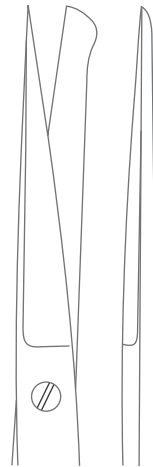

77-018-13
16.5 cm (5 ½")

Operating Scissors
Chirurgische Scheren
Tijeras quirúrgicas
Ciseaux chirurgicaux
Forbici per chirurgia



77-024-13
Systrunk Nail Splitting Scissor
Straight
Overall Length 13 cm (5")



Deaver Operating Scissor
Sharp/Blunt
Overall Length 14 cm (5 1/2")

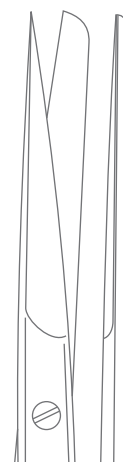

77-030-14
Straight



77-031-14
Curved

Operating Scissors
Chirurgische Scheren
Tijeras quirúrgicas
Ciseaux chirurgicaux
Forbici per chirurgia

77

SCISSORS



Mayo Dissecting Scissor
Straight



77-040-14
14.5 cm (5 ¾")



77-040-15
15 cm (6")



77-040-17
17 cm (6 ¾")



77-040-19
19 cm (7 ½")

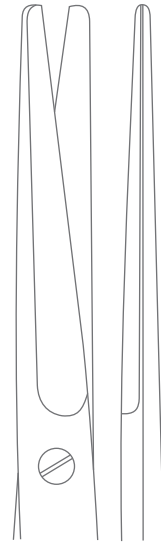

77-040-23
23.5 cm (9 ¼")

Operating Scissors
Chirurgische Scheren
Tijeras quirúrgicas
Ciseaux chirurgicaux
Forbici per chirurgia



Mayo Dissecting Scissor
Straight

SUPEREdge™



77-040-14 SC
14.5 cm (5 ¾")



77-040-15 SC
15 cm (6")



77-040-17 SC
17 cm (6 ¾")

Operating Scissors
Chirurgische Scheren
Tijeras quirúrgicas
Ciseaux chirurgicaux
Forbici per chirurgia



Mayo Dissecting Scissor
Curved



77-041-14
14.5 cm (5 ¾")



77-041-15
15 cm (6")



77-041-17
17 cm (6 ¾")

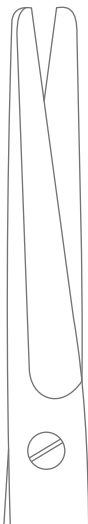

77-041-19
19 cm (7 ½")



77-041-23
23.5 cm (9 ¼")

Operating Scissors
Chirurgische Scheren
Tijeras quirúrgicas
Ciseaux chirurgicaux
Forbici per chirurgia



Mayo Dissecting Scissor
Curved

SUPERedge™

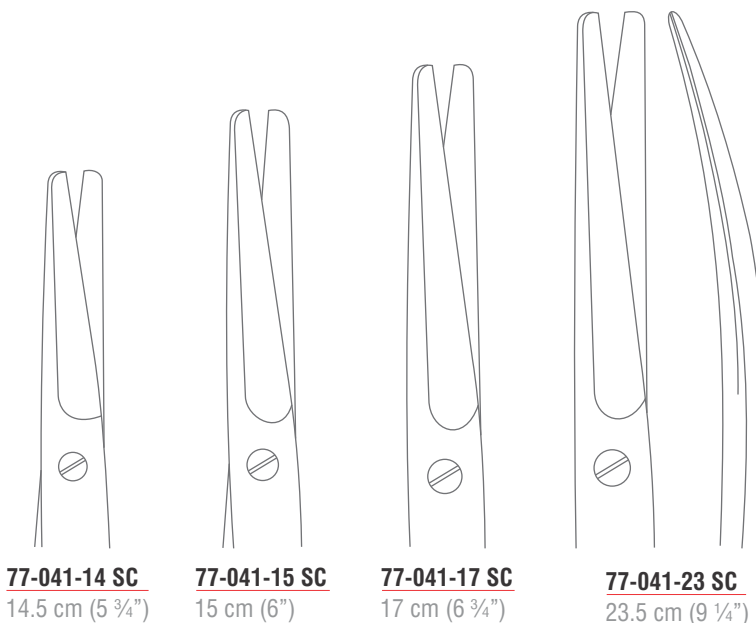

77-041-14 SC
14.5 cm (5 3/4")

77-041-15 SC
15 cm (6")

77-041-17 SC
17 cm (6 3/4")

77-041-23 SC
23.5 cm (9 1/4")

Dissecting Scissors
 Präparierscheren
 Tijeras de disección
 Ciseaux à dissection
 Forbici per dissezione



Mayo Dissecting Scissor
 With Chamfered Blades

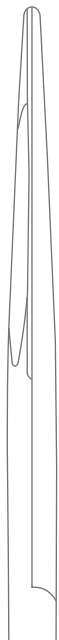

77-042-19
 Straight
 19 cm (7 ½")

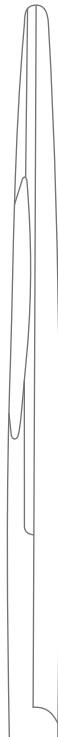

77-042-21
 Straight
 21.5 cm (8 ½")



77-043-19
 Curved
 19 cm (7 ½")



77-043-21
 Curved
 21.5 cm (8 ½")

Dissecting Scissors
Präparierscheren
Tijeras de disección
Ciseaux à dissection
Forbici per dissezione

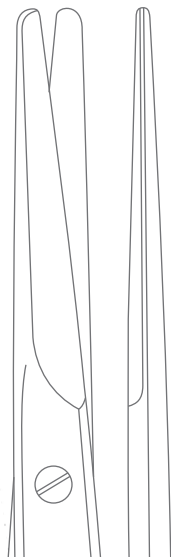

77-046-23
Straight
23 cm (9")



77-047-23
Curved
22.5 cm (9")

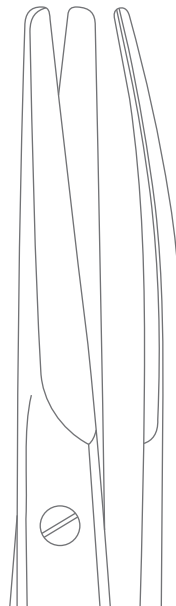

77-047-28
Curved
28 cm (11")

Mayo-Harrington Dissecting Scissor

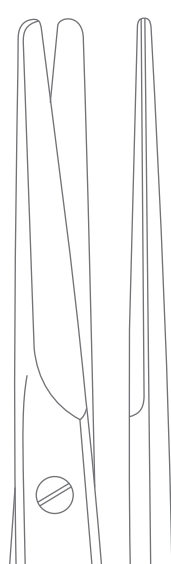

77-046-23 SC
Straight
23 cm (9")



77-047-23 SC
Curved
22.5 cm (9")

SUPERedge™

Mayo-Harrington Dissecting Scissor

Dissecting Scissors
Präparierscheren
Tijeras de disección
Ciseaux à dissection
Forbici per dissezione



Mayo-Stillie Dissecting Scissor
Straight

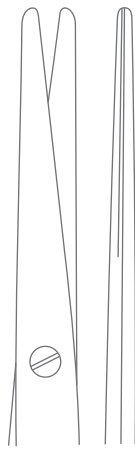

77-050-15
15 cm (6")

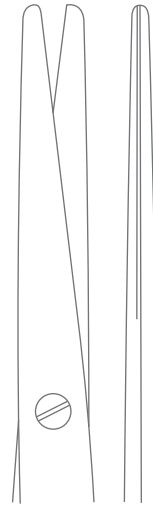

77-050-17
17 cm (6 3/4")



77-050-19
19.5 cm (7 3/4")

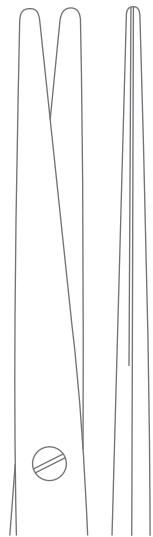

77-050-21
21.5 cm (8 1/2")

Dissecting Scissors
 Präparierscheren
 Tijeras de disección
 Ciseaux à dissection
 Forbici per dissezione

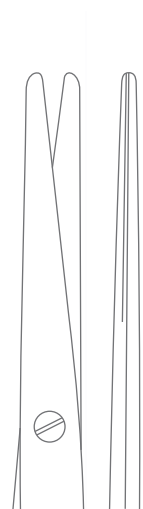

77-050-15 SC
 Straight
 15 cm (6")

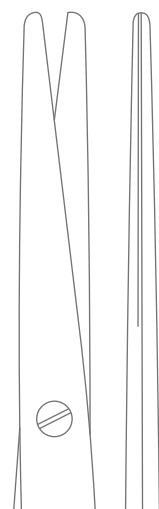

77-050-17 SC
 Straight
 17 cm (6 3/4")

SuperEdge™ Mayo-Style Dissecting Scissor



Dissecting Scissors
Präparierscheren
Tijeras de disección
Ciseaux à dissection
Forbici per dissezione



Mayo-Style Dissecting Scissor



77-051-15
Curved
15 cm (6")



77-051-17
Curved
17 cm (6 ¾")

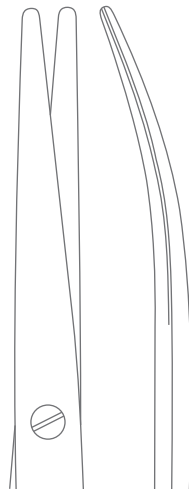

77-051-19
Curved
19.5 cm (7 ¾")



77-051-21
Curved
21.5 cm (8 ½")

Dissecting Scissors
 Präparierscheren
 Tijeras de disección
 Ciseaux à dissection
 Forbici per dissezione



SuperEdge™ Mayo-Style Dissecting Scissor

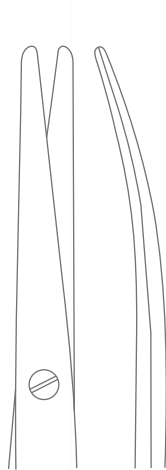

77-051-15 SC
 Curved
 15 cm (6")



77-051-17 SC
 Curved
 17 cm (6 ¾")

Dissecting Scissors
 Präparierscheren
 Tijeras de disección
 Ciseaux à dissection
 Forbici per dissezione



Mayo-Style Dissecting Scissor
 With Chamfered Blades



77-052-14
 Straight
 14 cm (5 1/2")



77-052-17
 Straight
 17 cm (6 3/4")



77-053-14
 Curved
 14 cm (5 1/2")



77-053-17
 Curved
 17 cm (6 3/4")

Dissecting Scissors
Präparierscheren
Tijeras de disección
Ciseaux à dissection
Forbici per dissezione



77-056-15
Straight



77-057-15
Curved



Stillé Dissecting Scissor
Overall Length 15 cm (6")



77-060-17
Straight



77-061-17
Curved



Mayo-Noble Gynecological Scissor
Overall Length 16.5 cm (6 1/2")



Gynecological Scissors
Gynäkologische Scheren
Tijeras para ginecología
Ciseaux à gynécologie
Forbici per ginecologia



Sims Gynecological Scissor
Straight

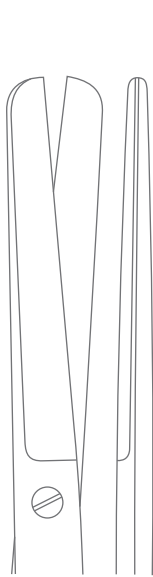

77-070-20
20 cm (8")

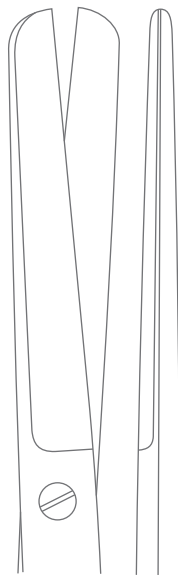

77-070-23
23 cm (9")



SuperEdge™ Sims Gynecological Scissor
Straight



77-070-20 SC
20 cm (8")

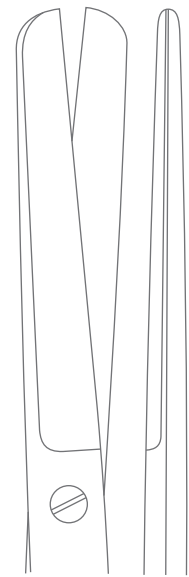

77-070-23 SC
23 cm (9")



Gynecological Scissors
Gynäkologische Scheren
Tijeras para ginecología
Ciseaux à gynécologie
Forbici per ginecologia



Sims Gynecological Scissor
Straight

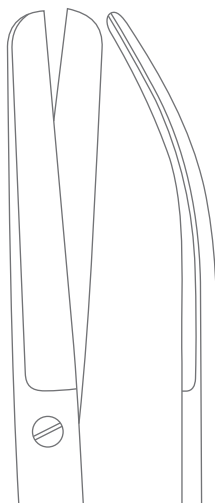

77-071-20
20 cm (8")



77-071-23
23 cm (9")

Gynecological Scissors
Gynäkologische Scheren
Tijeras para ginecología
Ciseaux à gynécologie
Forbici per ginecologia

SCISSORS



77-071-20 SC
20 cm (8")

77-071-23 SC
23 cm (9")

SuperEdge™ Sims Gynecological Scissor
Curved

SUPEREdge™

Gynecological Scissors
Gynäkologische Scheren
Tijeras para ginecología
Ciseaux à gynécologie
Forbici per ginecologia

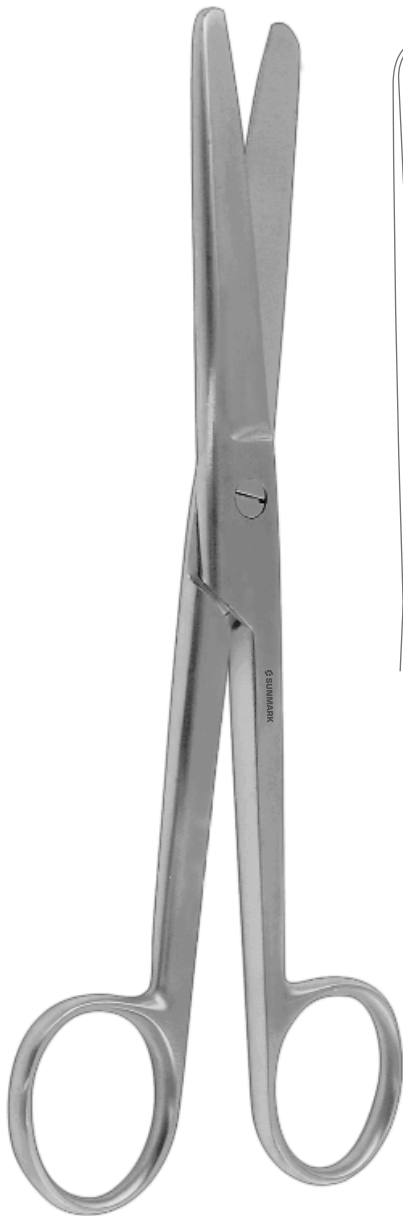

Doyen Gynecological Scissor
Overall Length 18.5 cm (7 1/4")

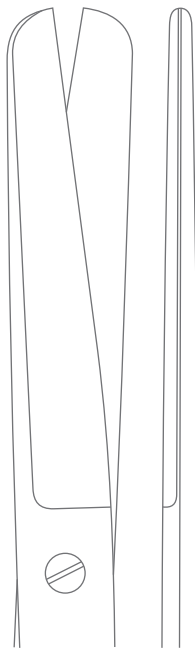

77-074-17
Straight

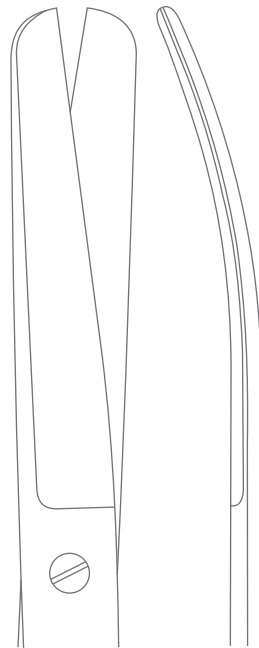

77-075-17
Curved

Gynecological Scissors
Gynäkologische Scheren
Tijeras para ginecología
Ciseaux à gynécologie
Forbici per ginecologia

SCISSORS



77-078-24

Sims-Siebold Gynecological Scissor

Straight

Overall Length 24.5 cm (9 3/4")

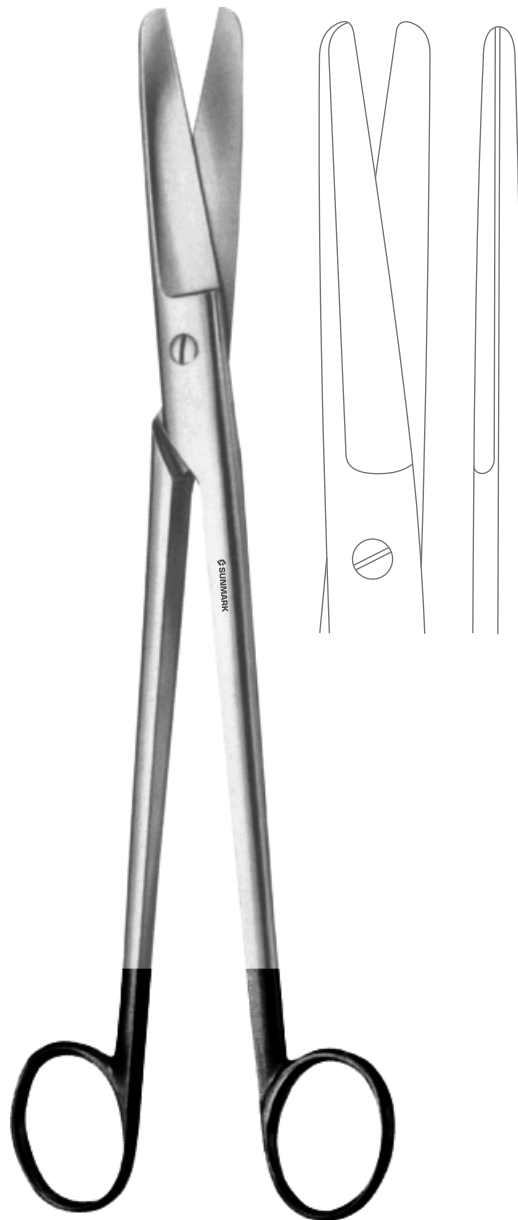

77-078-24 SC

SuperEdge™ Sims-Siebold Gynecological Scissor

Straight

Overall Length 24.5 cm (9 3/4")

SUPEREdge™

Gynecological Scissors
Gynäkologische Scheren
Tijeras para ginecología
Ciseaux à gynécologie
Forbici per ginecologia



77-079-24
Sims-Siebold Gynecological Scissor
Curved
Overall Length 24.5 cm (9 3/4")

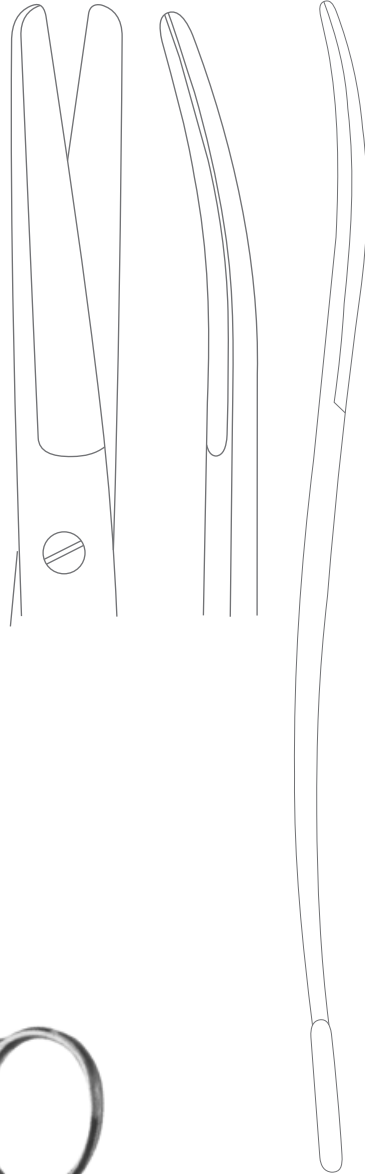

77-079-24 SC
SuperEdge™ Sims-Siebold Gynecological Scissor
Curved
Overall Length 24.5 cm (9 3/4")



SUPEREdge™

Gynecological Scissors
Gynäkologische Scheren
Tijeras para ginecología
Ciseaux à gynécologie
Forbici per ginecologia

77

SCISSORS

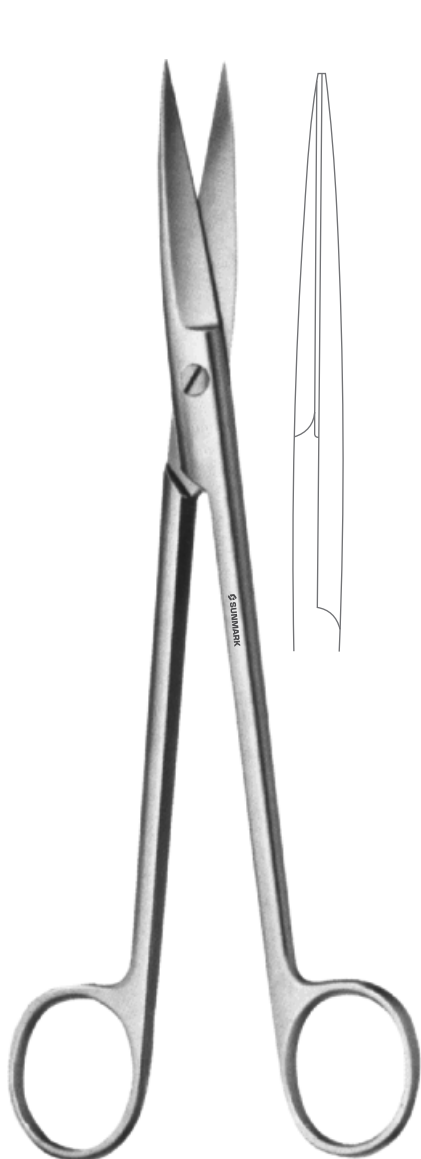

77-082-20
Sims Gynecological Scissor
Straight, Sharp/Sharp
Overall Length 20 cm (8")

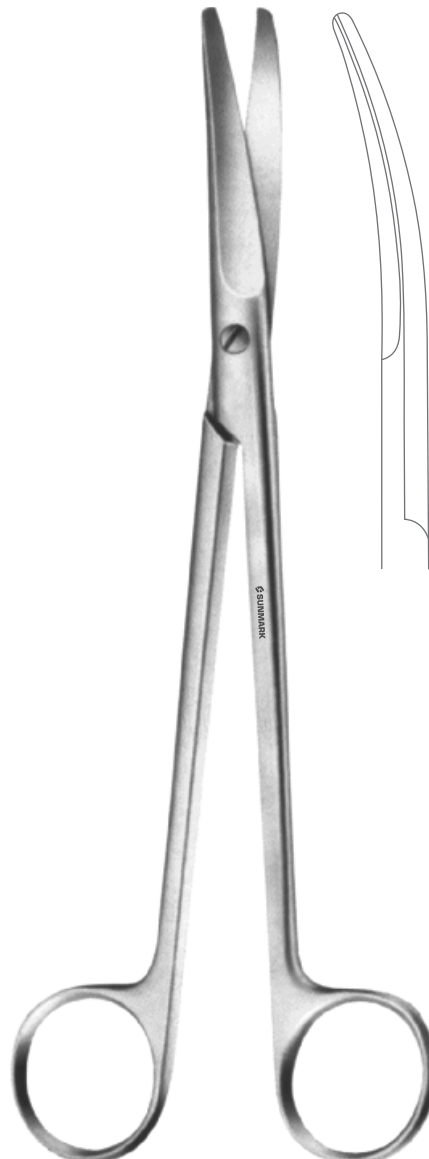

77-085-21
Sims Gynecological Scissor
Curved, Blunt/Blunt
Overall Length 21 cm (8 1/4")





Gynecological Scissors
Gynäkologische Scheren
Tijeras para ginecología
Ciseaux à gynécologie
Forbici per ginecologia



Wertheim Gynecological Scissor
Curved



77-087-20
20 cm (8")



77-087-23
23 cm (9")

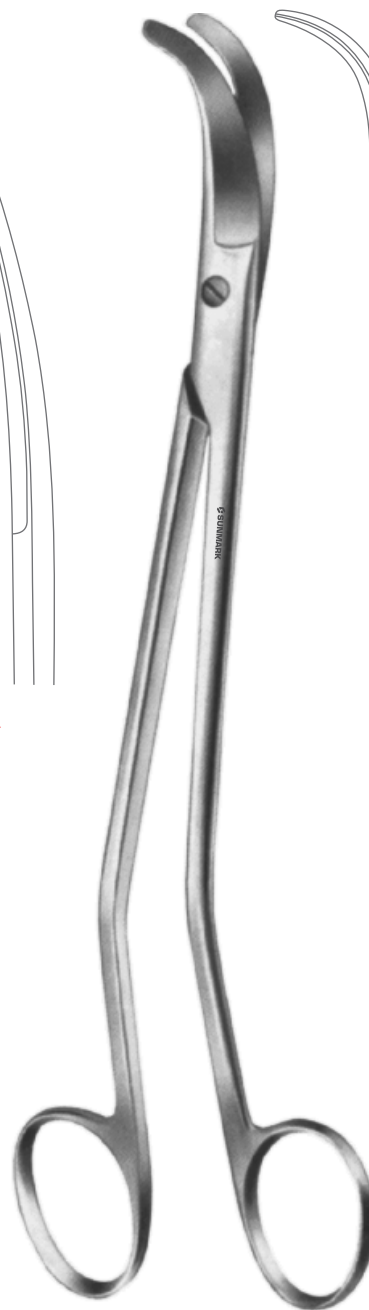

77-089-22
Bozemann Gynecological Scissor
S Shaped
Overall Length 22 cm (8 3/4")

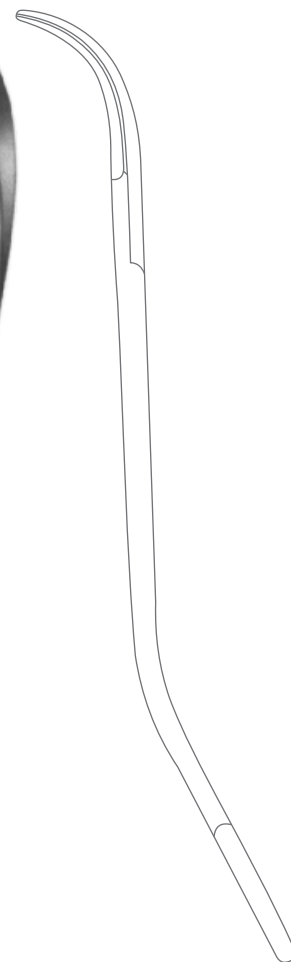

Ophthalmology Instruments
 Ophthalmologie Instrumente
 Oftalmologia Instrumentos
 Ophthalmologie Instruments
 Oftalmologia Strumenti



77-091-24
 24 cm (9 1/2")

77-091-24
 35 cm (13 3/4")



77-093-26
 26 cm (10 1/4")

77-093-26
 35 cm (13 3/4")

Kieback Parametrium Scissor
 Angled 90°
 Overall Length 24 cm (9 1/2")

Kieback Parametrium Scissor
 Curved to Side, One Probe Pointed Blade
 One Toothed Cutting Edge
 22 cm (8 3/4")

Dissecting Scissors
Präparierscheren
Tijeras de disección
Ciseaux à dissection
Forbici per dissezione

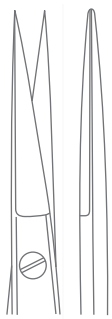

77-100-16
Straight

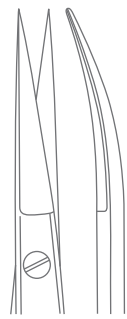

77-101-16
Curved

Kelly Dissecting Scissor
Overall Length 16 cm (6 1/4")

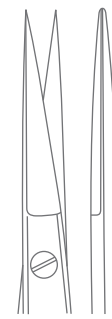

77-100-16 SC
Straight

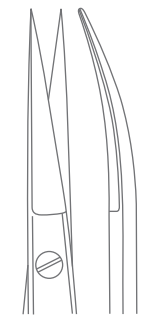

77-101-16 SC
Curved

SuperEdge™ Kelly Dissecting Scissor
Overall Length 16 cm (6 1/4")

SUPEREdge™

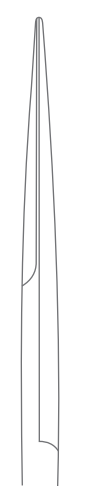

77-104-15
Straight

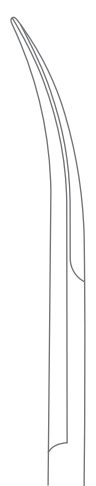

77-105-15
Curved

Joseph Dissecting Scissor
Overall Length 15 cm (6")

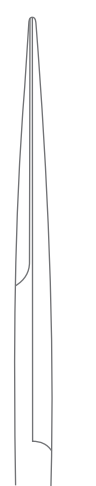

77-104-15 SC
Straight



77-105-15 SC
Curved

SuperEdge™ Joseph Dissecting Scissor
Overall Length 15 cm (6")

SUPEREdge™

Dissecting Scissors
Präparierscheren
Tijeras de disección
Ciseaux à dissection
Forbici per dissezione

77

THORAX, CARDIOVASCULAR SURGERY

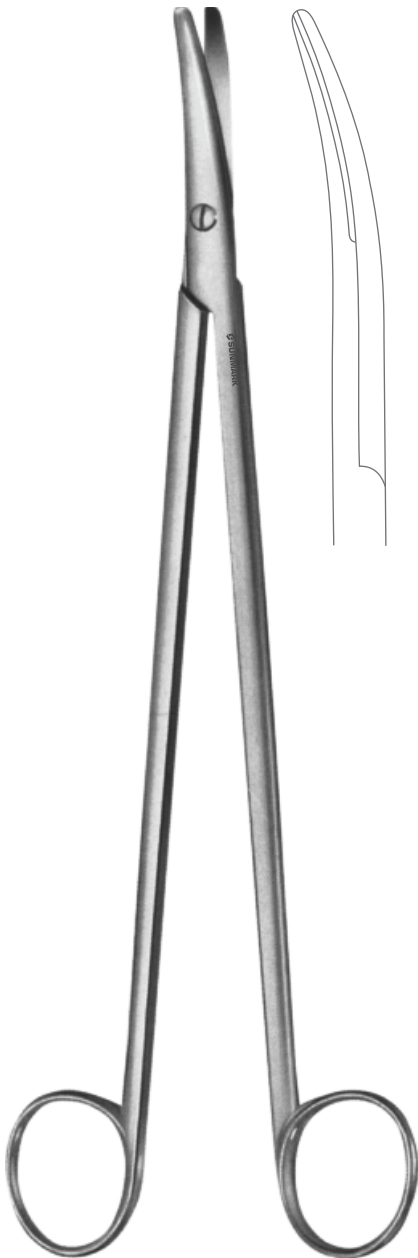

77-111-28
Weller Dissecting Scissor
Heavy Pattern
Overall Length 28 cm (11")



77-113-25
Resano Cartilage Scissor
Overall Length 25 cm (9 3/4")

Dissecting Scissors
 Präparierscheren
 Tijeras de disección
 Ciseaux à dissection
 Forbici per dissezione



Metzenbaum Dissecting Scissor
 Blunt/Blunt
 Overall Length 11.5 cm (4 1/2")

77-120-11
 Straight
 Blunt/Blunt

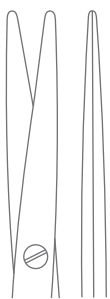

77-121-11
 Curved
 Blunt/Blunt



SuperEdge™ Metzenbaum Dissecting Scissor
 Blunt/Blunt
 Overall Length 11.5 cm (4 1/2")

77-120-11 SC
 Straight
 Blunt/Blunt

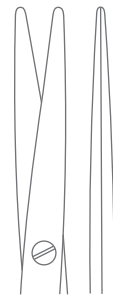

77-121-11 SC
 Curved



SUPEREdge™

Dissecting Scissors
 Präparierscheren
 Tijeras de disección
 Ciseaux à dissection
 Forbici per dissezione

THORAX, CARDIOVASCULAR SURGERY

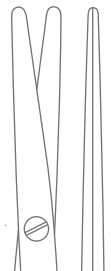

77-122-15
Straight



77-123-15
Curved

Metzenbaum Dissecting Scissor
 Blunt/Blunt
 Overall Length 15.5 cm (6")

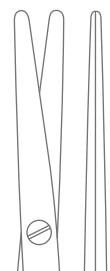

77-122-15 SC
Straight

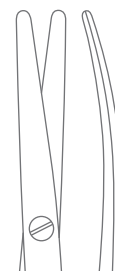

77-123-15 SC
Curved

SUPEREdge™

SuperEdge™ Metzenbaum Dissecting Scissor
 Blunt/Blunt
 Overall Length 15.5 cm (6")

Dissecting Scissors
 Präparierscheren
 Tijeras de disección
 Ciseaux à dissection
 Forbici per dissezione



Metzenbaum Dissecting Scissor
 Blunt/Blunt
 Overall Length 14.5 cm (5 3/4")

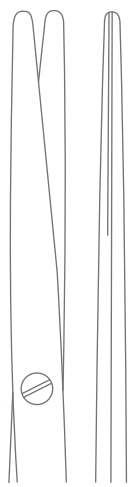

77-130-14
 Straight

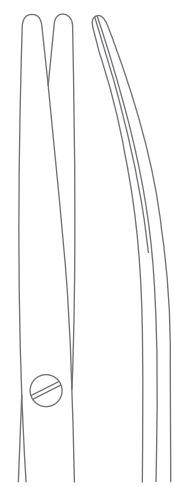

77-131-14
 Curved



SuperEdge™ Metzenbaum Dissecting Scissor
 Blunt/Blunt
 Overall Length 14.5 cm (5 3/4")

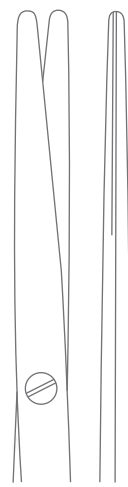

77-130-14 SC
 Straight

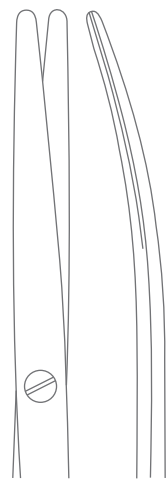

77-131-14 SC
 Curved

SUPEREdge™

Dissecting Scissors
Präparierscheren
Tijeras de disección
Ciseaux à dissection
Forbici per dissezione

THORAX, CARDIOVASCULAR SURGERY

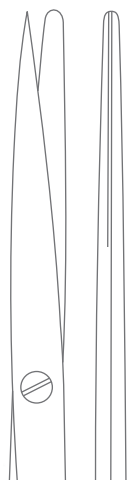

77-132-14
Straight



77-133-14
Curved

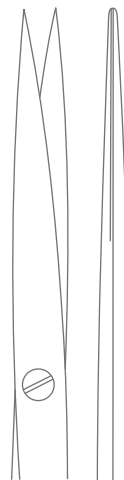

77-134-14
Straight



77-135-14
Curved

Metzenbaum Dissecting Scissor
Sharp/Blunt
Overall Length 14.5 cm (5 ¾")

Metzenbaum Dissecting Scissor
Sharp/Sharp
Overall Length 14.5 cm (5 ¾")



Dissecting Scissors
Präparierscheren
Tijeras de disección
Ciseaux à dissection
Forbici per dissezione



Metzenbaum-Nelson Dissecting Scissor
Straight, Blunt/Blunt

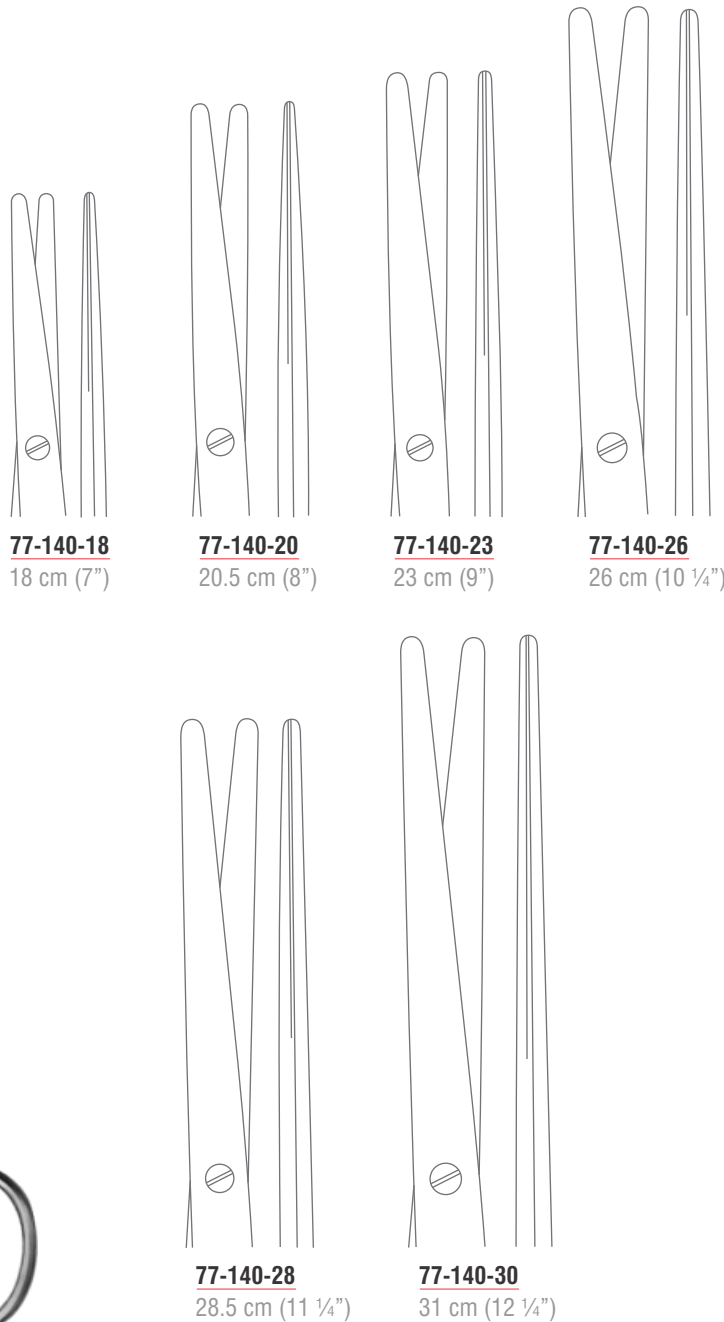

77-140-18
18 cm (7")

77-140-20
20.5 cm (8")

77-140-23
23 cm (9")

77-140-26
26 cm (10 1/4")

77-140-28
28.5 cm (11 1/4")

77-140-30
31 cm (12 1/4")

Dissecting Scissors
 Präparierscheren
 Tijeras de disección
 Ciseaux à dissection
 Forbici per dissezione

THORAX, CARDIOVASCULAR SURGERY

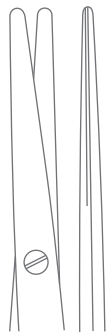

77-140-18 SC
18 cm (7")



77-140-20 SC
20.5 cm (8")

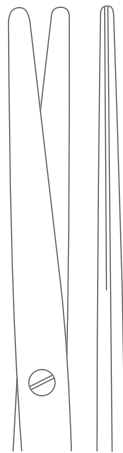

77-140-23 SC
23 cm (9")

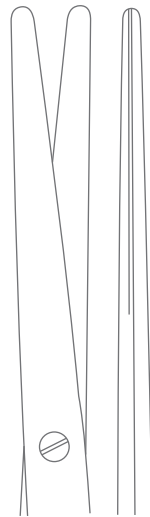

77-140-26 SC
26 cm (10 1/4")

SUPEREdge™

SuperEdge™ Metzenbaum-Nelson Dissecting Scissor
 Straight, Blunt/Blunt

Dissecting Scissors
 Präparierscheren
 Tijeras de disección
 Ciseaux à dissection
 Forbici per dissezione



Metzenbaum-Nelson Dissecting Scissor
 Curved, Blunt/Blunt

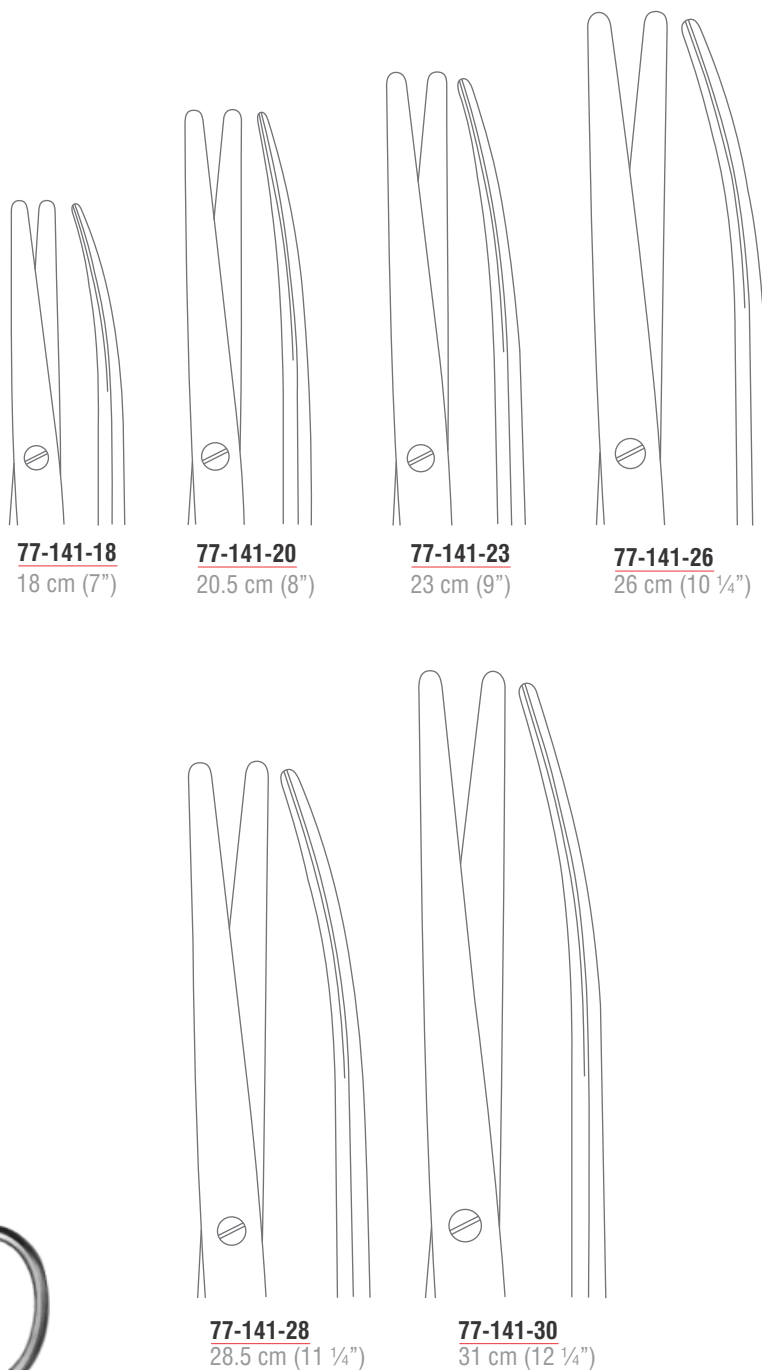

77-141-18
 18 cm (7")

77-141-20
 20.5 cm (8")

77-141-23
 23 cm (9")

77-141-26
 26 cm (10 1/4")

77-141-28
 28.5 cm (11 1/4")

77-141-30
 31 cm (12 1/4")

Dissecting Scissors
 Präparierscheren
 Tijeras de disección
 Ciseaux à dissection
 Forbici per dissezione

THORAX, CARDIOVASCULAR SURGERY

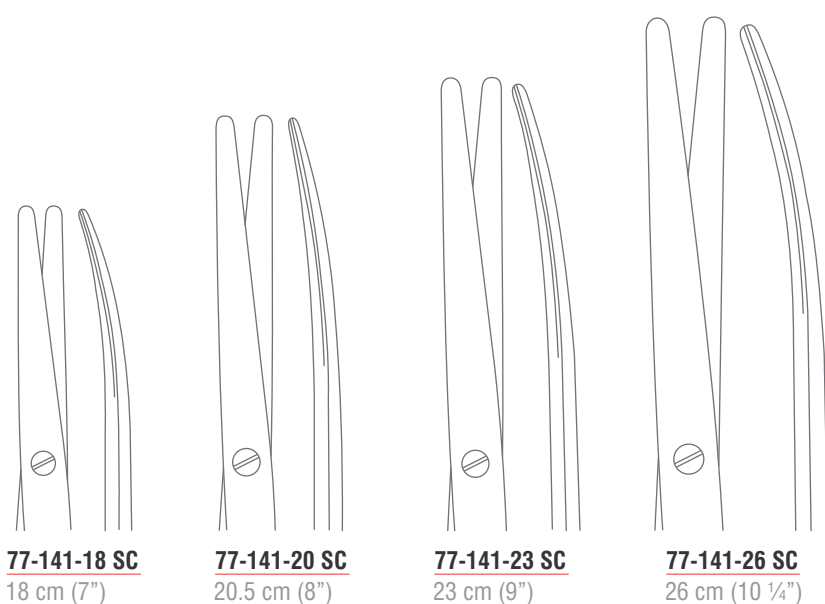

SUPEREdge™

SuperEdge™ Metzenbaum-Nelson Dissecting Scissor
 Curved, Blunt/Blunt



Dissecting Scissors
Präparierscheren
Tijeras de disección
Ciseaux à dissection
Forbici per dissezione

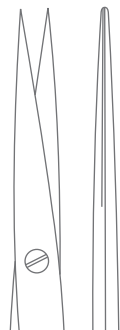

77-144-18
18 cm (7")

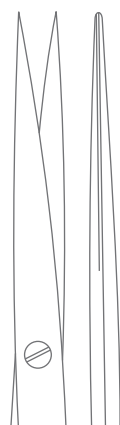

77-144-20
20.5 cm (8")

Metzenbaum-Nelson Dissecting Scissor
Straight, Sharp/Sharp



77-145-18
18 cm (7")



77-145-20
20.5 cm (8")

Metzenbaum-Nelson Dissecting Scissor
Curved, Sharp/Sharp

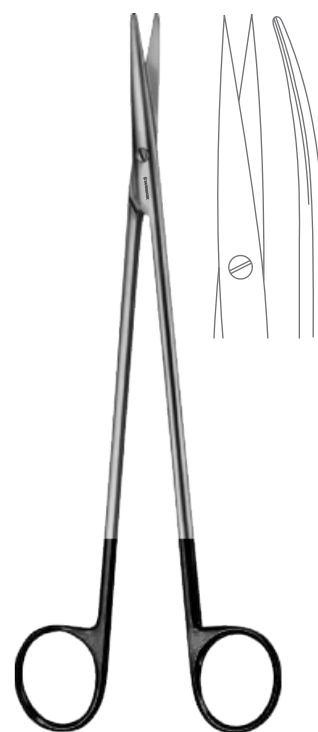

77-145-18 SC
Metzenbaum-Nelson Dissecting Scissor
Curved, Sharp/Sharp
Overall Length 18 cm (7")

SUPEREdge™

Dissecting Scissors
 Präparierscheren
 Tijeras de disección
 Ciseaux à dissection
 Forbici per dissezione

THORAX, CARDIOVASCULAR SURGERY



77-146-14



77-147-14



77-148-15
Straight



77-149-15
Curved

Metzenbaum Dissecting Scissor
 Straight, Sharp/Sharp
 One Serrated Cutting Edge Instead Of Toothed
 Overall Length 14.5 cm (5 3/4")

Metzenbaum Nerve Dissecting Scissor
 Overall Length 15.5 cm (6")

Dissecting Scissors
 Präparierscheren
 Tijeras de disección
 Ciseaux à dissection
 Forbici per dissezione



McIndoe Cartilage Scissor
 Toothed
 Overall Length 18.5 cm (7 1/4")

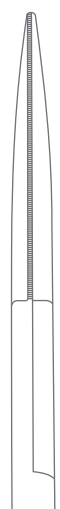

77-154-18
 Straight

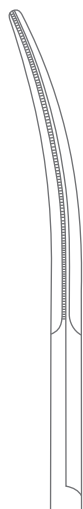

77-155-18
 Curved



77-157-18
Martin Cartilage Scissor
 Curved
 Overall Length 18.5 cm (7 1/4")

Face-lift Scissors
Face-lift-Scheren
Tijeras para Face-Lift
Ciseaux pour Face-lift
Forbici per Face-lift



77-161-18 SC
Kaye Face-Lift Scissor
Curved
Overall Length 18.5 cm (7 1/4")



Gorney Face-Lift Scissor

SUPEREdge™

77-166-12 SC
Straight
12.5 cm (5")

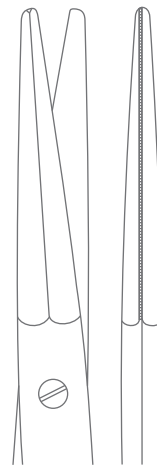

77-166-19 SC
Straight
19.5 cm (7 3/4")

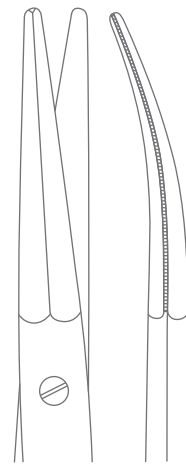

77-167-19 SC
Curved
19.5 cm (7 3/4")

SUPEREdge™

Face-lift Scissors
 Face-lift-Scheren
 Tijeras para Face-Lift
 Ciseaux pour Face-lift
 Forbici per Face-lift

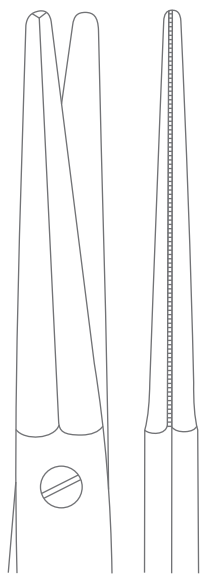

77-170-17 SC
Aston Face-Lift Scissor
 Straight
 Overall Length 17 cm (6 3/4")

SUPEREdge™

Dissecting Scissors
 Präparierscheren
 Tijeras de disección
 Ciseaux à dissection
 Forbici per dissezione

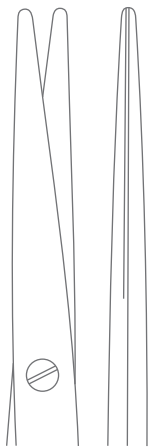

77-176-16
Straight



77-177-16
Curved



77-176-16 SC
Straight



77-177-16 SC
Curved

SUPEREdge™

Lexer Dissecting Scissor
Overall Length 16 cm (6 1/4")

SuperEdge™ Lexer Dissecting Scissor
Overall Length 16 cm (6 1/4")

Nasal Scissors
Nasenscheren
Tijeras nasales
Ciseaux nasaux
Forbici nasali



77-181-10
Curved
Sharp/Sharp

Cottle-Masing Plastic Surgery Scissor
Overall Length 10.5 cm (4 1/4")

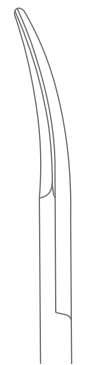

77-183-10
Curved
Blunt/Blunt

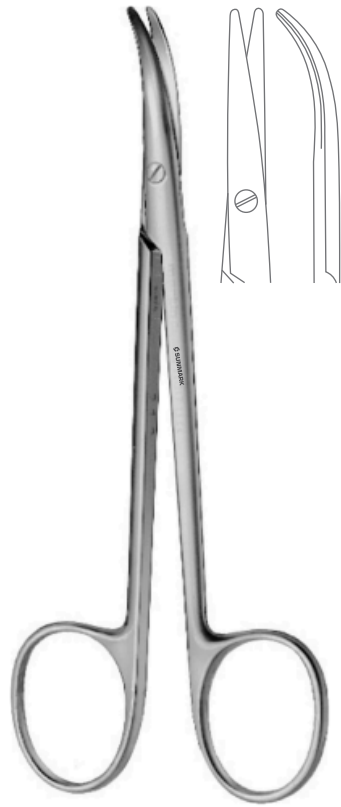

77-187-11
Cinelli Nasal Scissor
Curved
Overall Length 11.5 cm (4 1/2")

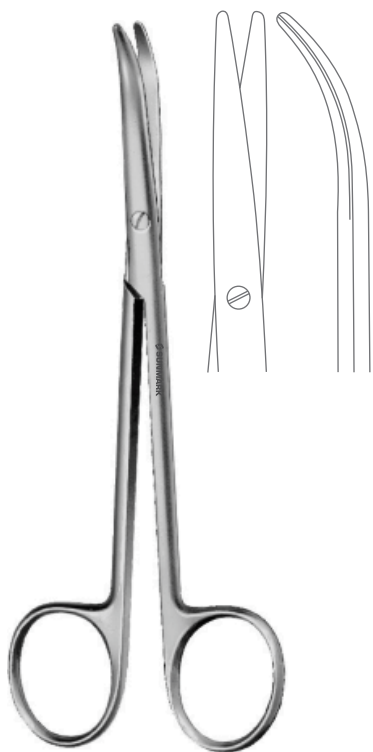

77-189-14
Fomon Nasal Scissor
Curved
Overall Length 14 cm (5 1/2")

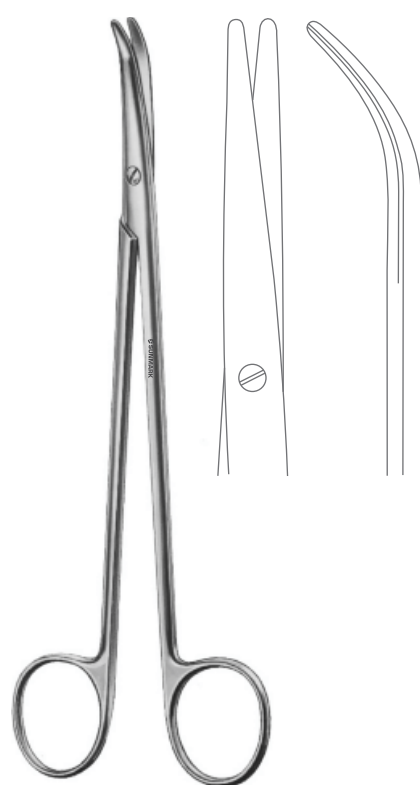

77-191-19
Thorek Dissecting Scissor
Curved
Overall Length 18.5 cm (7 1/4")

Dissecting Scissors
Präparierscheren
Tijeras de disección
Ciseaux à dissection
Forbici per dissezione



77-194-10
Straight



77-195-10
Curved



77-196-16
Straight

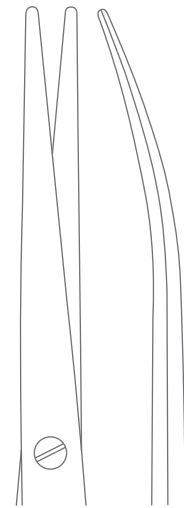

77-197-16
Curved

Lexer-Baby Dissecting Scissor
Overall Length 10 cm (4")

Lexer-Fine Delicate Dissecting Scissor
Slender Pattern
Overall Length 16.5 cm (6 1/2")



77-200-14
Straight

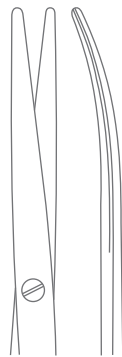

77-201-14
Curved

Metzenbaum-Fine Delicate Dissecting Scissor
Blunt/Blunt, Slender Pattern
Overall Length 14.5 cm (5 3/4")



77-200-14 SC
Straight

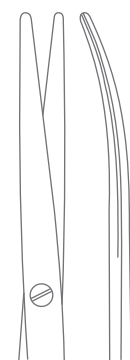

77-201-14 SC
Curved

SUPEREdge™

SuperEdge™ Metzenbaum-Fine Delicate Dissecting Scissor
Blunt/Blunt, Slender Pattern
Overall Length 14.5 cm (5 3/4")

Dissecting Scissors
 Präparierscheren
 Tijeras de disección
 Ciseaux à dissection
 Forbici per dissezione



77-202-14
Straight



77-203-14
Curved



Metzenbaum-Fine Delicate Dissecting Scissor
 Sharp/Sharp, Slender Pattern
 Overall Length 14.5 cm (5 3/4")



Dissecting Scissors
Präparierscheren
Tijeras de disección
Ciseaux à dissection
Forbici per dissezione

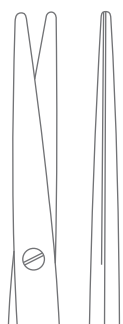

77-210-18
18 cm (7")



77-210-20
20 cm (8")

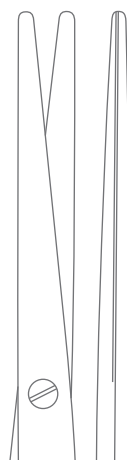

77-210-23
23 cm (9")

Metzenbaum-Fine Delicate Dissecting Scissor
Straight, Blunt/Blunt, Slender Pattern

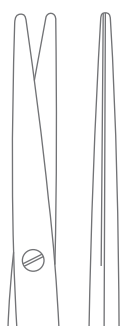

77-210-18 SC
18 cm (7")



77-210-20 SC
20 cm (8")

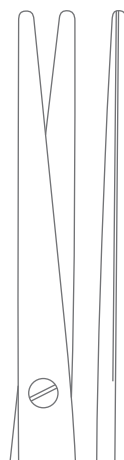

77-210-23 SC
23 cm (9")

SUPEREdge™

SuperEdge™ Metzenbaum-Fine Delicate Dissecting Scissor
Straight, Blunt/Blunt, Slender Pattern

Dissecting Scissors
Präparierscheren
Tijeras de disección
Ciseaux à dissection
Forbici per dissezione

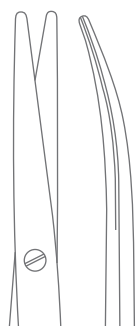

77-211-18
18 cm (7")



77-211-20
20 cm (8")



77-211-23
23 cm (9")

Metzenbaum-Fine Delicate Dissecting Scissor
Straight, Blunt/Blunt, Slender Pattern

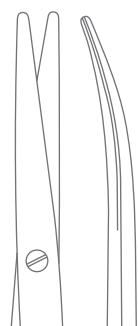

77-211-18 SC
18 cm (7")

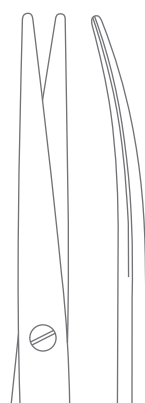

77-211-20 SC
20 cm (8")



77-211-23 SC
23 cm (9")

SUPEREdge™

SuperEdge™ Metzenbaum-Fine Delicate Dissecting Scissor
Straight, Blunt/Blunt, Slender Pattern

Dissecting Scissors
Präparierscheren
Tijeras de disección
Ciseaux à dissection
Forbici per dissezione

SCISSORS



77-214-18
18 cm (7")

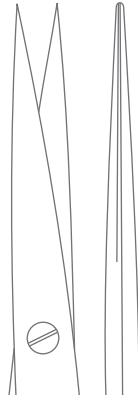

77-214-20
20 cm (8")



77-214-23
23 cm (9")

Metzenbaum-Fine Delicate Dissecting Scissor
Straight, Sharp/Sharp, Slender Pattern

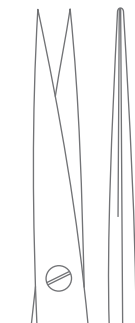

77-214-18 SC
18 cm (7")

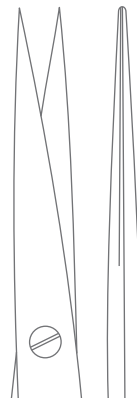

77-214-20 SC
20 cm (8")

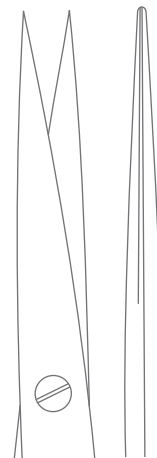

77-214-23 SC
23 cm (9")

SUPEREDGE™

Metzenbaum-Fine Delicate Dissecting Scissor
Straight, Sharp/Sharp, Slender Pattern

Dissecting Scissors
Präparierscheren
Tijeras de disección
Ciseaux à dissection
Forbici per dissezione



77-215-18
18 cm (7")

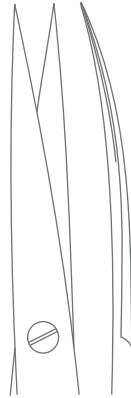

77-215-20
20 cm (8")



77-215-23
23 cm (9")

Metzenbaum-Fine Delicate Dissecting Scissor
Straight, Sharp/Sharp, Slender Pattern

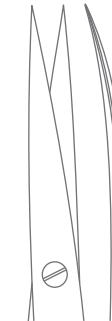

77-215-18 SC
18 cm (7")



77-215-20 SC
20 cm (8")

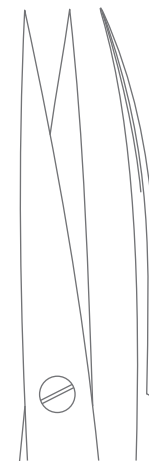

77-215-23 SC
23 cm (9")

SUPEREdge™

SuperEdge™ Metzenbaum-Fine Delicate Dissecting Scissor
Straight, Sharp/Sharp, Slender Pattern

Dissecting Scissors
Präparierscheren
Tijeras de disección
Ciseaux à dissection
Forbici per dissezione

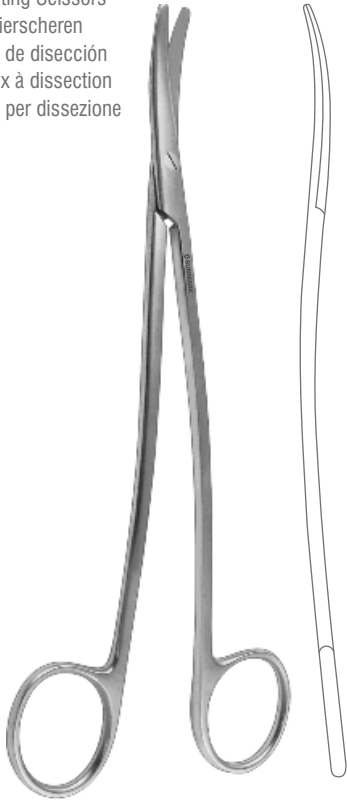

77-219-18
18 cm (7")

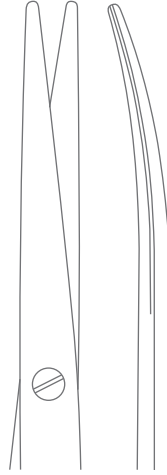

77-219-20
20 cm (8")

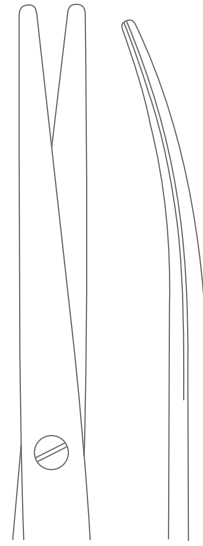

77-219-23
23 cm (9")

Metzenbaum-Fine Delicate Dissecting Scissor
Curved, S Shaped



77-223-12
12.5 cm (5")



77-223-18
18 cm (7")



77-226-14
Straight



77-227-14
Curved

Salyer Cleft Palate Dissecting Scissor
Curved, Fine Pattern

Sanvenero Dissecting Scissor
Overall Length 14 cm (5 1/2")

Face-lift Scissors
 Face-lift-Scheren
 Tijeras para Face-Lift
 Ciseaux pour Face-lift
 Forbici per Face-lift



Tenotomy Scissor
 Overall Length 11.5 cm (4 1/2")



77-230-11
 Straight



77-231-11
 Curved



Peck-Joseph Face-Lift Scissor
 Overall Length 14.5 cm (5 3/4")

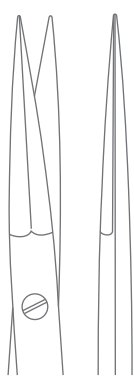

77-236-14
 Straight
 Sharp/Sharp



77-237-14
 Curved
 Sharp/Sharp



77-238-14
 Straight
 Blunt/Blunt



77-239-14
 Curved
 Blunt/Blunt



Dissecting Scissors
Präparierscheren
Tijeras de disección
Ciseaux à dissection
Forbici per dissezione

77

SCISSORS



77-241-12

Shea Vein Graft Scissor

Curved

Overall Length 12 cm (4 3/4")

Dissecting Scissors
Präparierscheren
Tijeras de disección
Ciseaux à dissection
Forbici per dissezione



Ragnell (Kilner) Dissecting Scissor
Curved

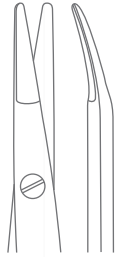

77-243-12
12 cm (4 3/4")

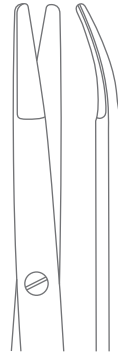

77-243-15
15 cm (6")

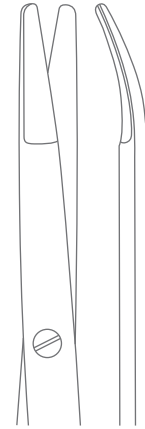

77-243-18
18 cm (7")



SuperEdge™ Ragnell (Kilner) Dissecting Scissor
Curved



77-243-12 SC
12 cm (4 3/4")

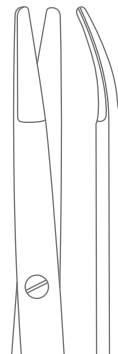

77-243-15 SC
15 cm (6")

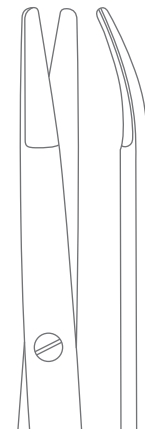

77-243-18 SC
18 cm (7")

SUPEREdge™

Dissecting Scissors
Präparierscheren
Tijeras de disección
Ciseaux à dissection
Forbici per dissezione

77

SCISSORS



77-245-15
Nerve Dissecting Scissor
Curved, Semi Sharp
15 cm (6")



77-248-14
Straight

77-249-14
Curved

Dissecting Scissor
Overall Length 14.5 cm (5 3/4")

Dissecting Scissors
Präparierscheren
Tijeras de disección
Ciseaux à dissection
Forbici per dissezione

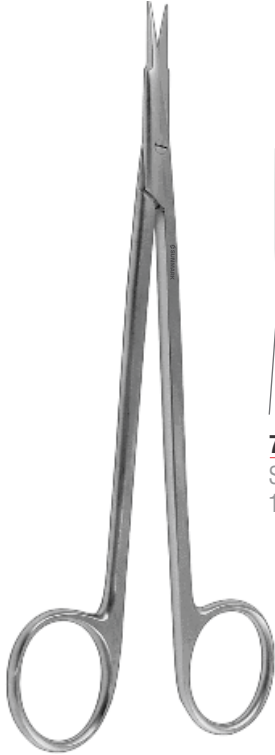

Reynolds Dissecting Scissor

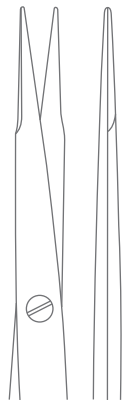

77-250-15
Straight
15.5 cm (6")

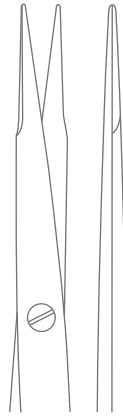

77-250-18
Straight
18 cm (7")



77-251-15
Curved
15.5 cm (6")



77-251-18
Curved
18 cm (7")



SuperEdge™ Reynolds Dissecting Scissor

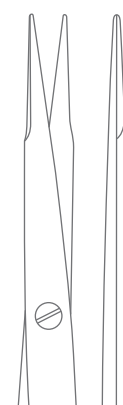

77-250-15 SC
Straight
15.5 cm (6")

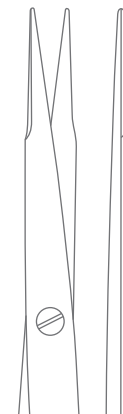

77-250-18 SC
Straight
18 cm (7")



77-251-15 SC
Curved
15.5 cm (6")



77-251-18 SC
Curved
18 cm (7")

SUPEREdge™

Dissecting Scissors
Präparierscheren
Tijeras de disección
Ciseaux à dissection
Forbici per dissezione

77

SCISSORS

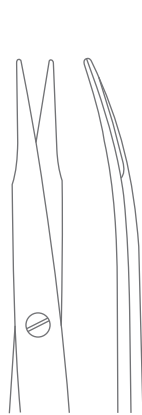
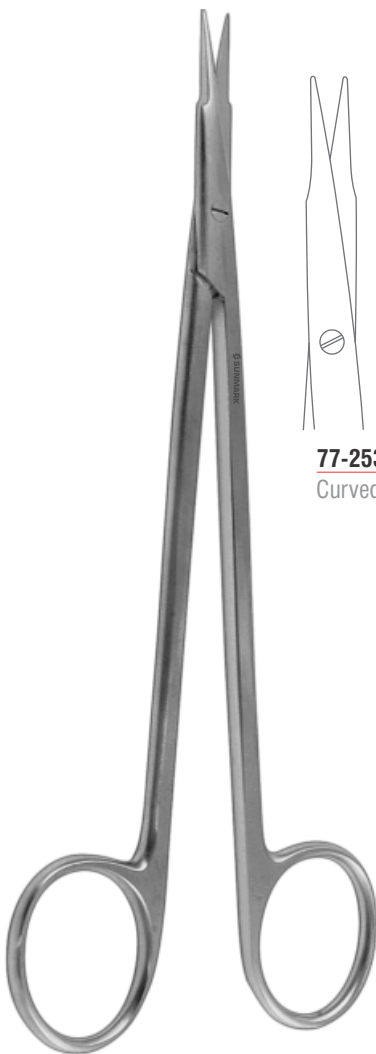

77-253-13
Curved

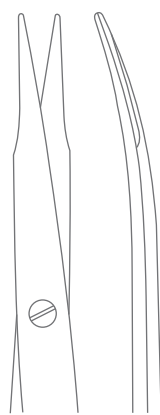

77-253-15
Curved

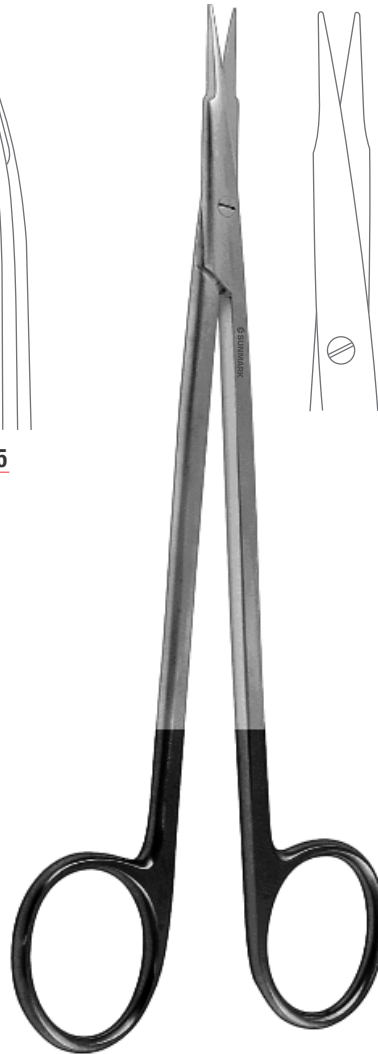

77-253-15 SC
SuperEdge™ Jameson Dissecting Scissor
Curved
Overall Length 15.5 cm (6")

SUPEREdge™

Dissecting Scissors
 Präparierscheren
 Tijeras de disección
 Ciseaux à dissection
 Forbici per dissezione



77-257-13
Jameson-Werber Dissecting Scissor
 Curved
 Overall Length 13 cm (5")

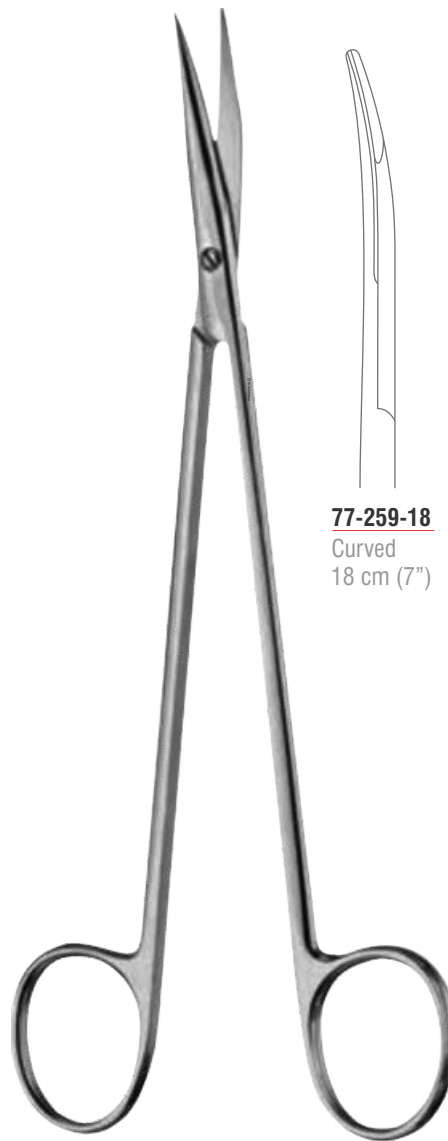

Potts Dissecting Scissor

77-259-18
 Curved
 18 cm (7")

77-259-20
 Curved
 20.5 cm (8")

Vascular Scissors
Gefäßscheren
Tijeras vasculares
Ciseaux vasculaires
Forbici vascolari

77

SCISSORS

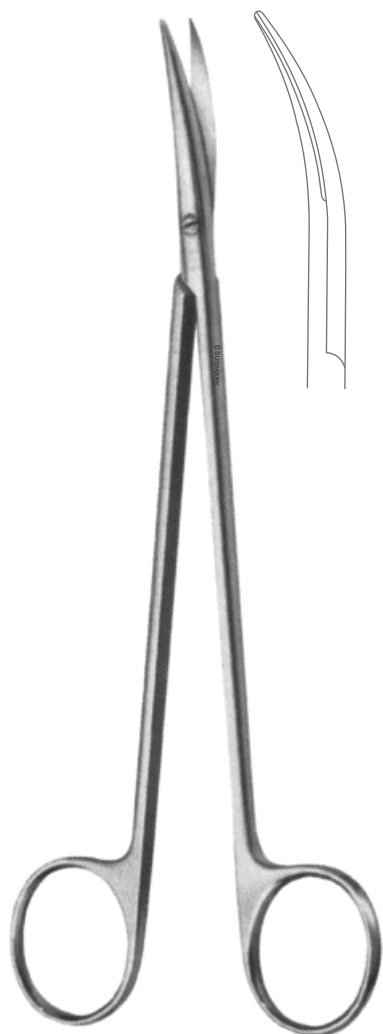

77-261-17
DeBakey Arteriotomy Scissor
Curved
Overall Length 17.5 cm (7")



Vascular Scissor
Overall Length 19 cm (7 1/2")



77-264-19
Straight



77-265-19
Curved

Dissecting Scissors
 Präparierscheren
 Tijeras de disección
 Ciseaux à dissection
 Forbici per dissezione

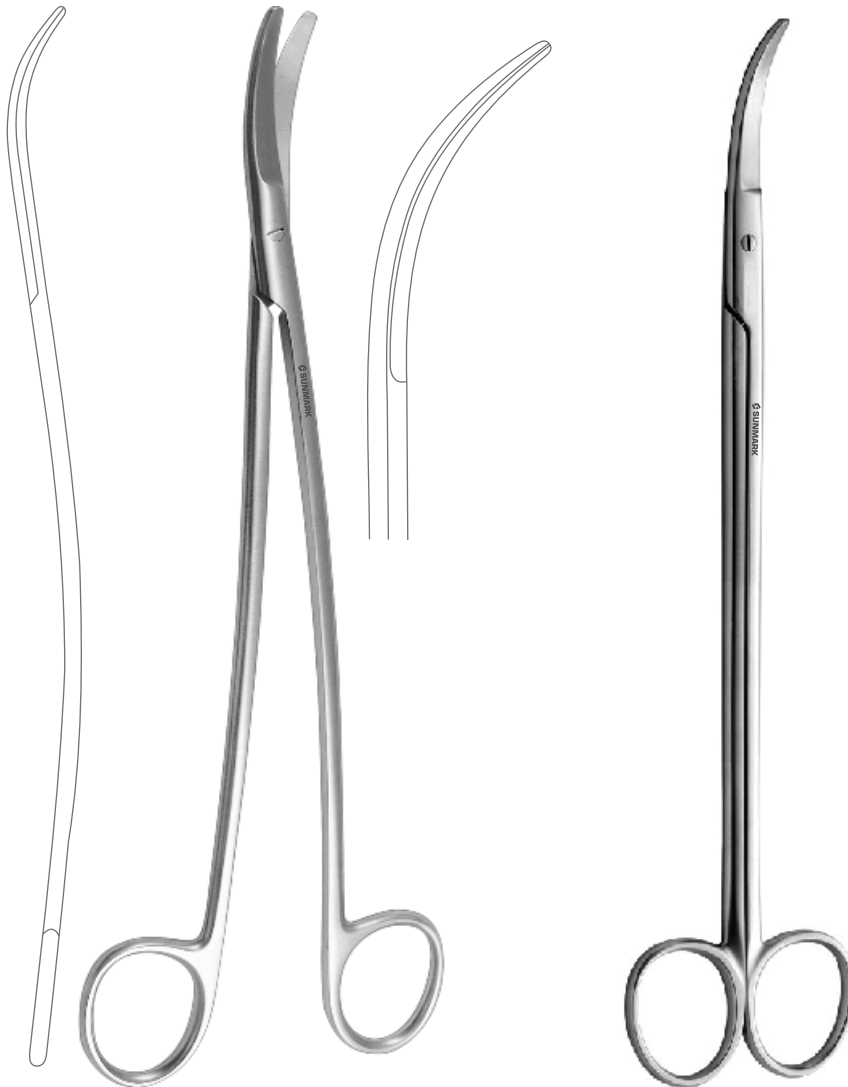

77-267-24
Satinsky Thoracic Scissor
 Curved
 Overall Length 25.5 cm (10")

77-267-25
Thomson Valve Scissor
 Strongly Curved, With One Serrated Blade
 Overall Length 25.5 cm (10")

Vascular Scissors
Gefäßscheren
Tijeras vasculares
Ciseaux vasculaires
Forbici vascolari

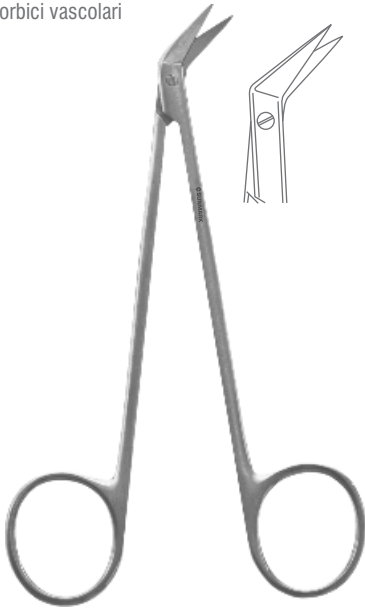

77-269-12
Diethrich-Salyer Cleft Palate Dissecting Scissor
Angled
Overall Length 12 cm (4 3/4")



Peripheral Vascular Scissor
Overall Length 12.5 cm (5")

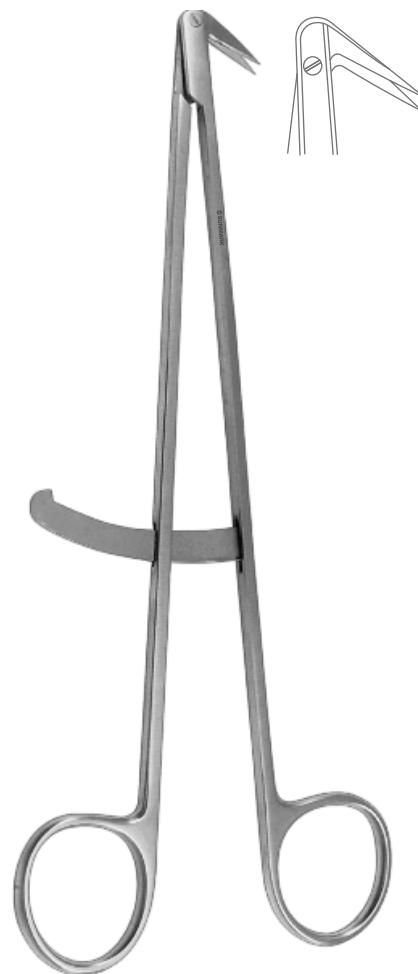
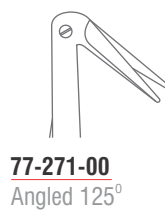
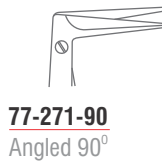

77-275-00
Diethrich Vascular Scissor
Angled, 125° With Guide
Overall Length 17.5 cm (7")

Vascular Scissors
Gefäßscheren
Tijeras vasculares
Ciseaux vasculaires
Forbici vascolari



DeBakey Vascular Scissor
Overall Length 16.5 cm (6 1/2")

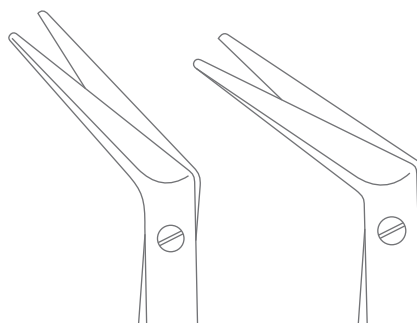

77-277-25
Angled 25°

77-277-45
Angled 45°

77-277-60
Angled 60°

Vascular Scissors
Gefäßscheren
Tijeras vasculares
Ciseaux vasculaires
Forbici vascolari

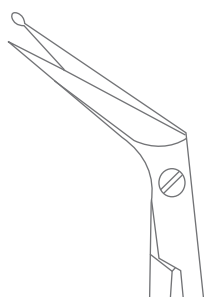

77-279-19
Angled 60°
With One Probe Tip



77-281-25
Angled 25°

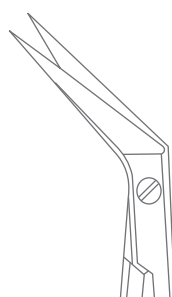

77-281-45
Angled 45°

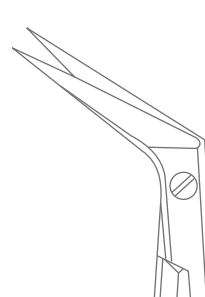

77-281-60
Angled 60°

Potts-Smith Vascular Scissor
Angled 60° With Probe Tip
Overall Length 18 cm (7")



77-281-25 SC
Angled 25°

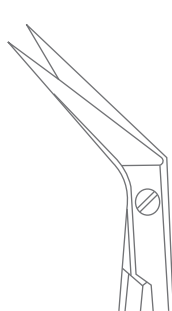

77-281-45 SC
Angled 45°

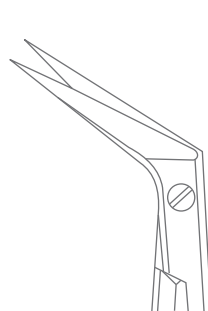

77-281-60 SC
Angled 60°

SUPEREdge™

SuperEdge™ Potts-Smith Vascular Scissor
Overall Length 18 cm (7")

Vascular Scissors
Gefäßscheren
Tijeras vasculares
Ciseaux vasculaires
Forbici vascolari



Angled on Flat

77-283-19
Potts-Smith Vascular Scissor
Angled 60°
Overall Length 18.5 cm (7 1/4")

Vascular Scissors
 Gefäßscheren
 Tijeras vasculares
 Ciseaux vasculaires
 Forbici vascolari

SCISSORS

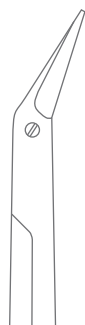

77-285-25
 Angled 25°
 12 mm

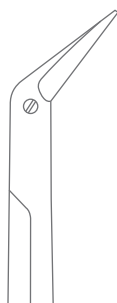

77-285-45
 Angled 45°
 12 mm

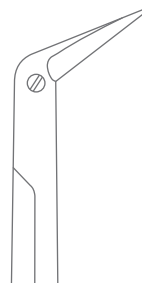

77-285-60
 Angled 60°
 12 mm

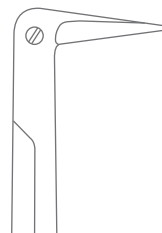

77-285-90
 Angled 90°
 12 mm

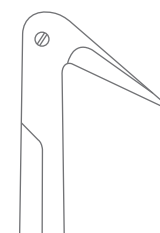

77-287-00
 Angled 125°
 12 mm

Standard Blade

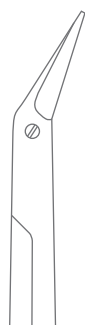

77-289-25
 Angled 25°
 10 mm

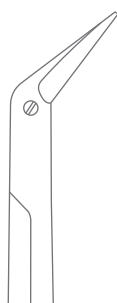

77-289-45
 Angled 45°
 10 mm

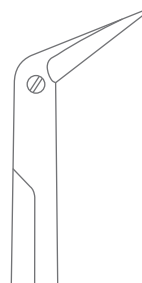

77-289-60
 Angled 60°
 10 mm

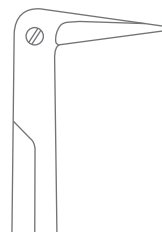

77-289-90
 Angled 90°
 10 mm

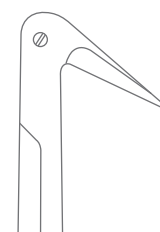

77-291-00
 Angled 125°
 10 mm

Delicate Blade

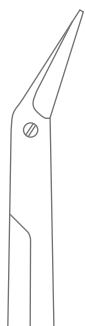

77-293-25
 Angled 25°
 8 mm

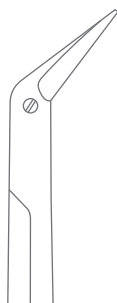

77-293-45
 Angled 45°
 8 mm

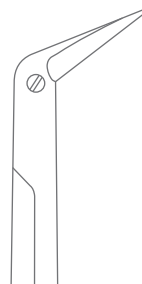

77-293-60
 Angled 60°
 8 mm

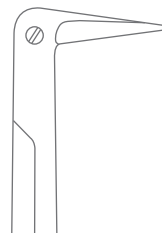

77-293-90
 Angled 90°
 8 mm

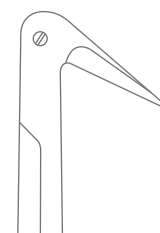

77-295-00
 Angled 125°
 8 mm

Ultra Delicate Blade



Diethrich-Potts Vascular Scissor
 Overall Length 18 cm (7")



Vascular Scissors
Gefäßscheren
Tijeras vasculares
Ciseaux vasculaires
Forbici vascolari

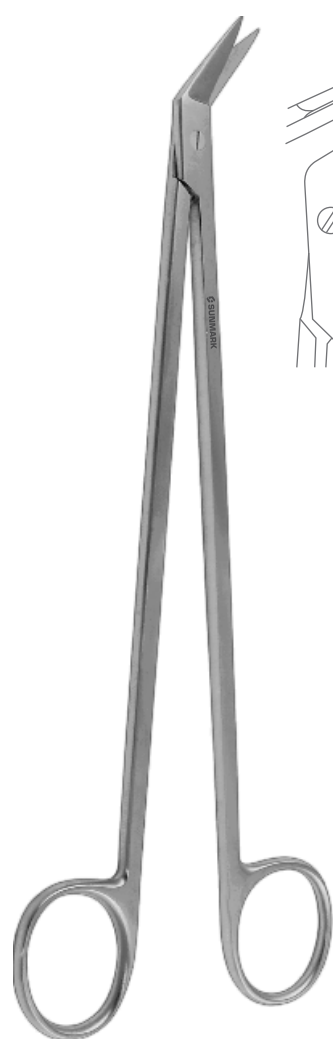

77-299-22
Potts-De Martel Cardiovascular Scissor
Angled 60°
Overall Length 22 cm (8 3/4")

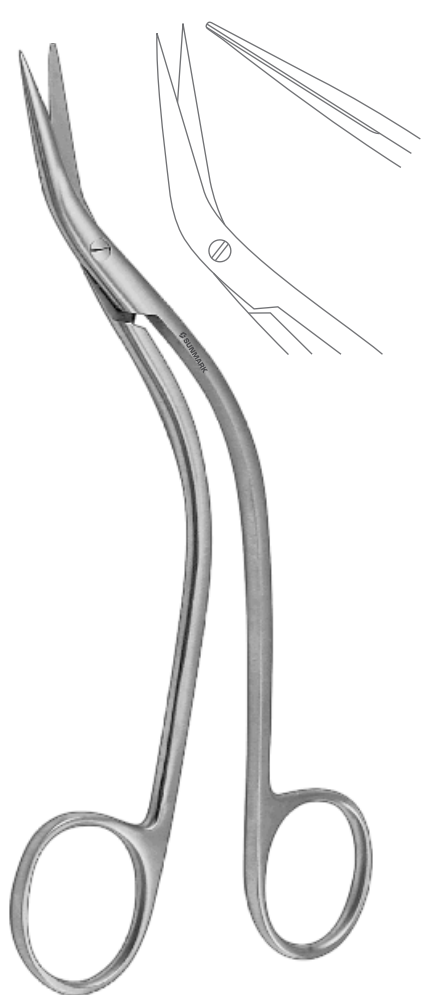

77-301-16
DeBakey Offset Scissor
S Shaped
Overall Length 15.5 cm (6")

Vascular Scissors
Gefäßscheren
Tijeras vasculares
Ciseaux vasculaires
Forbici vascolari

77

SCISSORS

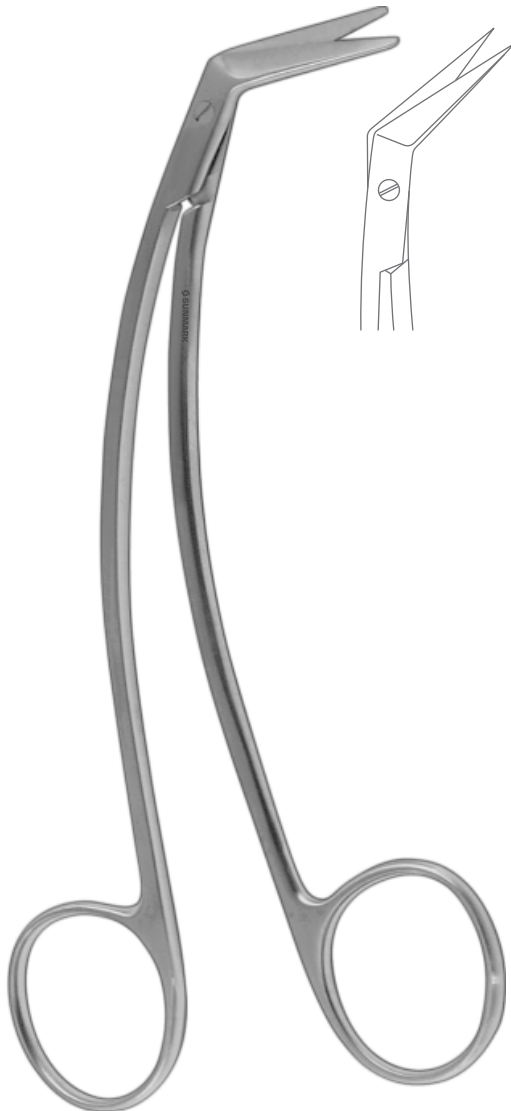

77-303-15
Favaloro Offset Scissor
Angled
Overall Length 15 cm (6")



77-306-12
Vascular Scissor
One Blade Probe
Overall Length 12 cm (4 ¾")



Vascular Scissors
Gefäßscheren
Tijeras vasculares
Ciseaux vasculaires
Forbici vascolari

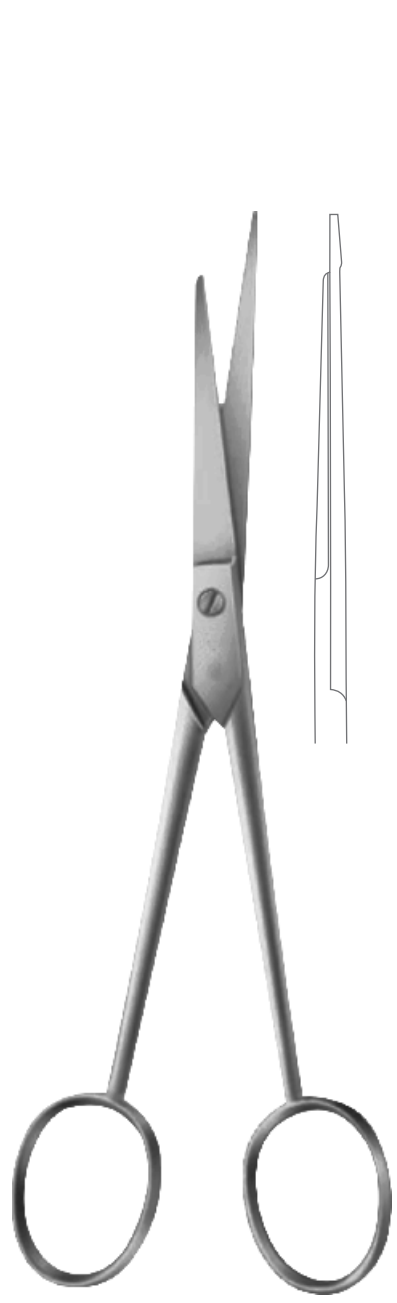

77-308-14
Vascular Scissor
One Blade Probe
Overall Length 14.5 cm (5 ¾")

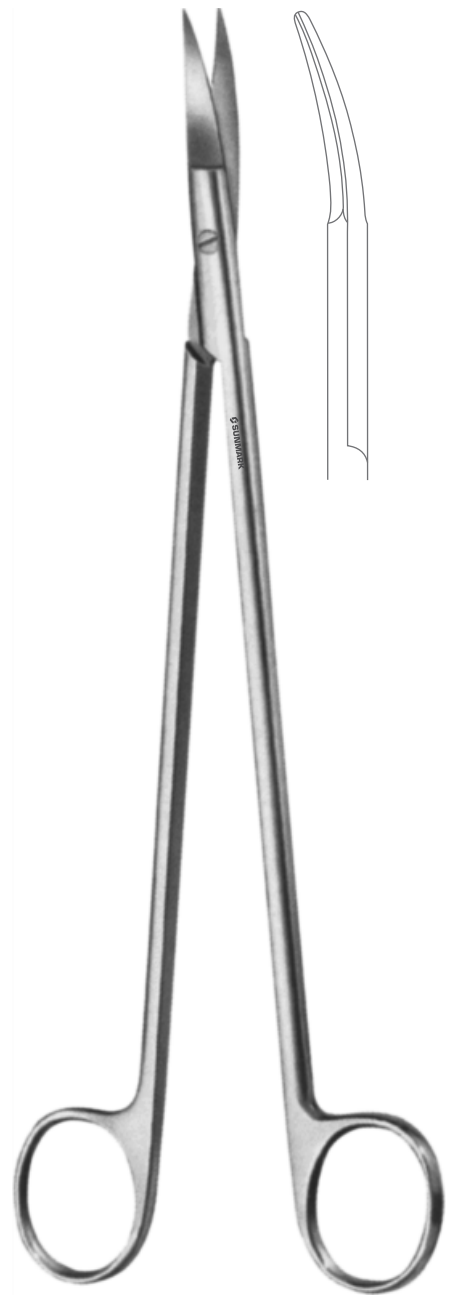

77-311-22
Strully Vascular Scissor
Curved
Overall Length 22 cm (8 ¾")

Vascular Scissors
Gefäßscheren
Tijeras vasculares
Ciseaux vasculaires
Forbici vascolari

77

SCISSORS



77-312-22
Vascular Scissor
Straight
Overall Length 22.5 cm (8 ¾")

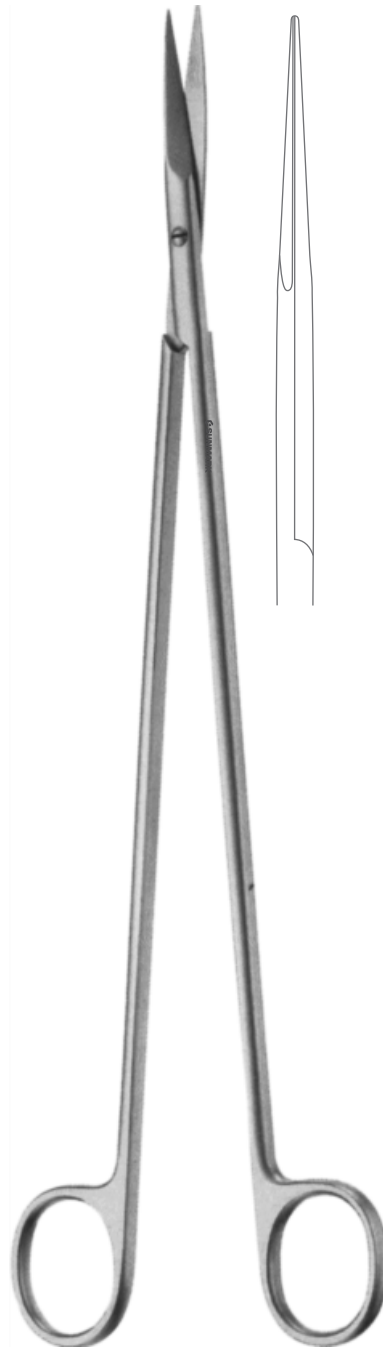

77-314-28
Barre Vascular Scissor
Straight
Overall Length 28 cm (11")

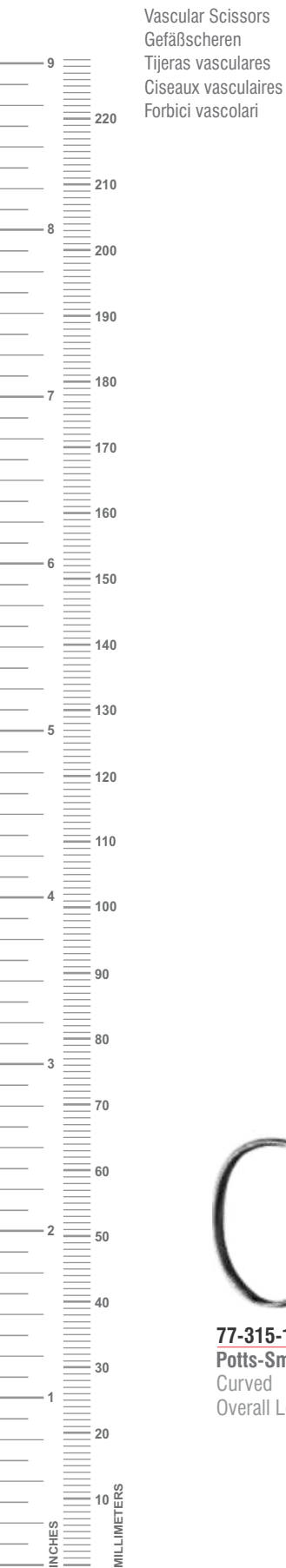

Vascular Scissors
Gefäßscheren
Tijeras vasculares
Ciseaux vasculaires
Forbici vascolari



77-315-19
Potts-Smith Vascular Scissor
Curved
Overall Length 19 cm (7 1/2")



77-317-19
Cooley Vascular Scissor
Curved
Overall Length 19 cm (7 1/2")

Vascular Scissors
Gefäßscheren
Tijeras vasculares
Ciseaux vasculaires
Forbici vascolari

77

SCISSORS

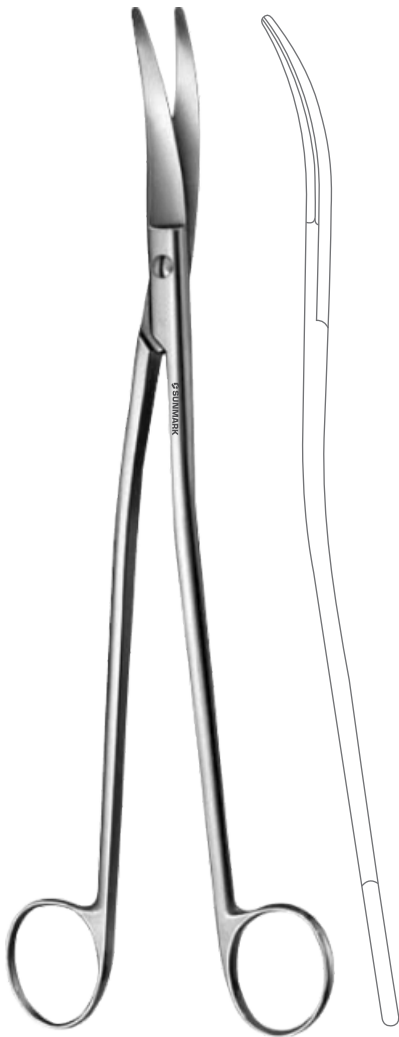

77-319-23
Klinkenberg-Loth Vascular Scissor
S Shaped
Overall Length 23 cm (9")



77-323-23
Olivecrona Trigeminal Scissor
Toothed, Length 120 mm
Overall Length 23 cm (9")

Dissecting Scissors
 Präparierscheren
 Tijeras de disección
 Ciseaux à dissection
 Forbici per dissezione

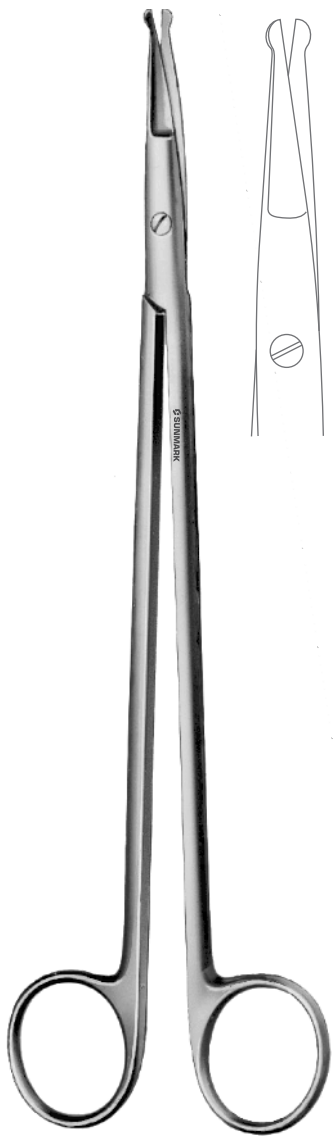

77-325-23
Stully Neurological Scissor
 Curved
 Overall Length 22.5 cm (8 ¾")

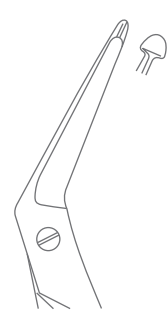
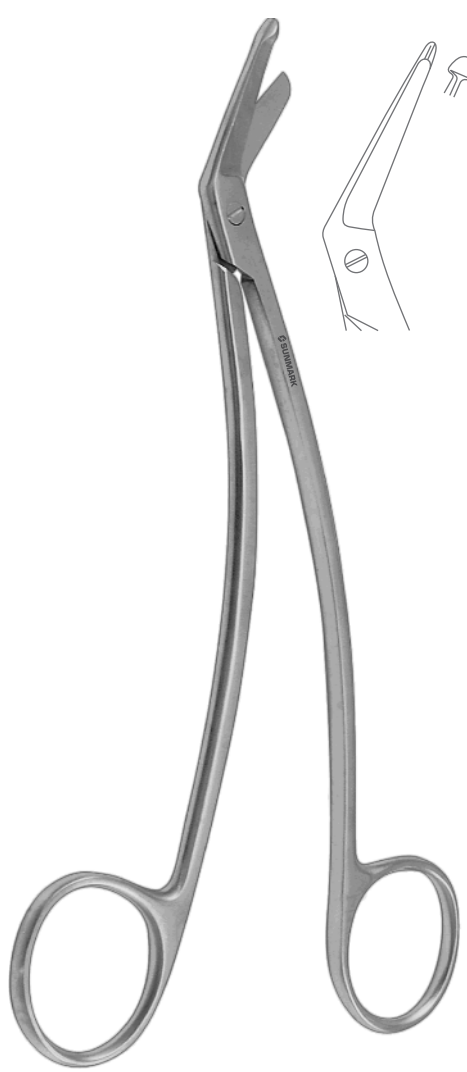

77-327-17
Schmieden-Taylor Dissecting Scissor
 One Blade Probed
 Overall Length 16.5 cm (6 ½")

Dissecting Scissors
 Präparierscheren
 Tijeras de disección
 Ciseaux à dissection
 Forbici per dissezione

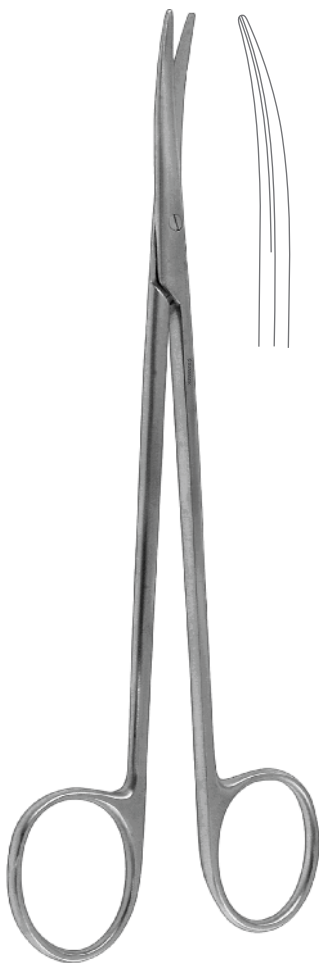

77-329-17
Toennis-Adson Dissecting Scissor
 Curved
 Overall Length 17.5 cm (7")



Toennis Dissecting Scissor
 Overall Length 18 cm (7")



77-332-18
 Straight
 Very Delicate



77-334-18
 Straight
 Delicate



77-335-18
 Curved
 Delicate

Bone Shear



77-341-21
Killian Bone Shear
Overall Length 21 cm (8 1/4")



77-343-21
Muehling Bone Shear
Overall Length 21 cm (8 1/4")



Tonsil Scissors

77

SCISSORS



77-345-20
Caplan Septum Scissor
One Toothed Cutting Edge
Overall Length 20 cm (8")



77-347-18
Prince Tonsil Scissor
Overall Length 18 cm (7")

Tonsil Scissors



Dean Tonsil Scissor
Angled Upwards
Overall Length 17.5 cm (7")

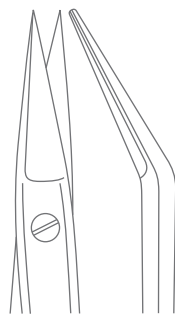

77-351-17
Angled Upwards

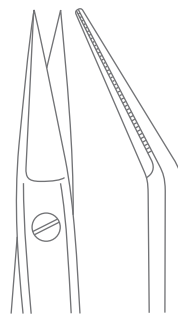

77-353-17
Toothed
Angled Upwards



77-355-19
Good Tonsil Scissor
Overall Length 19.5 cm (7 3/4")

Nasal Scissors
Nasenscheren
Tijeras nasals
Ciseaux nasaux
Forbici nasali

77

SCISSORS



77-357-15
Fomon Nasal Scissor
Overall Length 15 cm (6")



77-357-15 SC
SuperEdge™ Fomon Nasal Scissor
Overall Length 15 cm (6")

SUPEREdge™



Nasal Scissors
Nasenscheren
Tijeras nasals
Ciseaux nasaux
Forbici nasali



77-359-16
Cottle Nasal Scissor
Overall Length 16 cm (6 1/4")

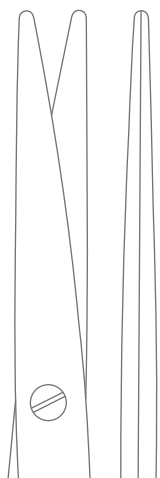

77-359-16 SC
SuperEdge™ Cottle Nasal Scissor
Overall Length 16 cm (6 1/4")

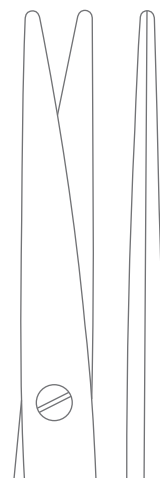

Nasal Scissors
Nasenscheren
Tijeras nasals
Ciseaux nasaux
Forbici nasali

77

SCISSORS



77-361-18
Heymann Nasal Scissor
Overall Length 18.5 cm (7 1/4")



77-361-18 SC
SuperEdge™ Heymann Nasal Scissor
Overall Length 18.5 cm (7 1/4")

SUPEREdge™



77-363-18
Heymann Nasal Scissor
One Toothed Cutting Edge
Overall Length 18.5 cm (7 1/4")



77-363-18
Heymann Nasal Scissor
One Toothed Cutting Edge
Overall Length 18.5 cm (7 1/4")

Nasal Scissors
Nasenscheren
Tijeras nasals
Ciseaux nasaux
Forbici nasali



77-367-11
Angled
Blunt/Blunt

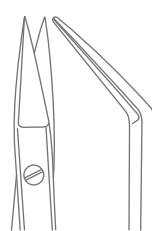

77-369-11
Angled
Sharp/Sharp



77-371-14
SuperEdge™ Walter Nasal Scissor
Angled
Overall Length 14 cm (5 1/2")

Episiotomy Scissors
Episiotomiescheren
Tijeras para episiotomía
Ciseaux à épisiotomie
Forbici per episiotomia

77

SCISSORS



77-373-18
Waldmann Nasal Scissor
One Toothed Cutting Edge
Overall Length 18 cm (7")



77-381-14
Braun-Stadler Episiotomy Scissor
Overall Length 14.5 cm (5 3/4")

Episiotomy Scissors, Umbilical Scissors
 Episiotomiescheren, Nabelschnurscheren
 Tijeras para episiotomía, Tijeras umbilicales
 Ciseaux à épisiotomie, Ciseaux pour le cordon ombilical
 Forbici per episiotomia, Forbici ombelicali

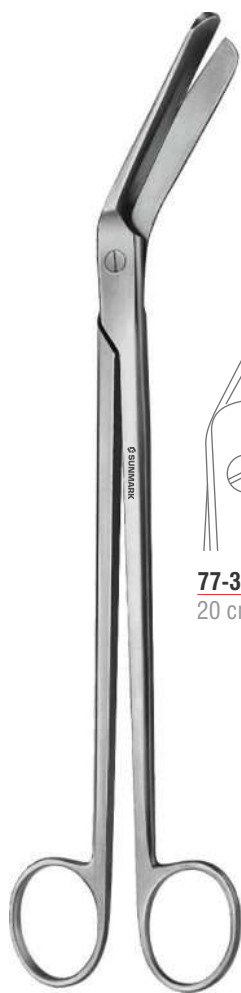

77-383-20
20 cm (8")

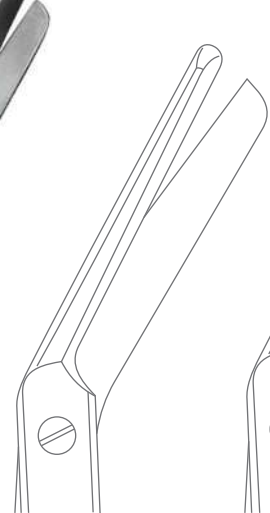

77-383-22
23 cm (9")

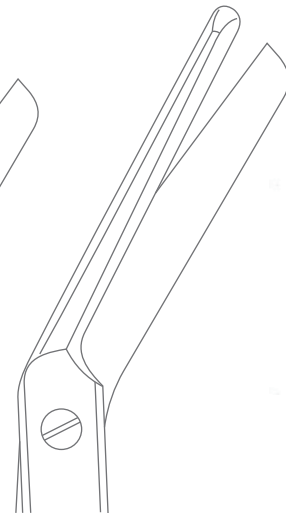

77-383-20
Braun-Stadler Episiotomy Scissor
20 cm (8")



77-385-10
Braun-Stadler Episiotomy Scissor
Overall Length 10.5 cm (4 1/4")

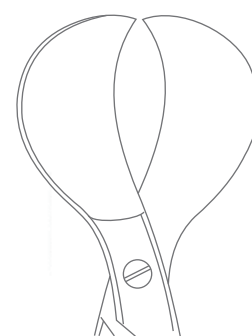

Umbilical Scissors
Nabelschnurscheren
Tijeras umbilicales
Ciseaux pour le cordon ombilical
Forbici ombelicali

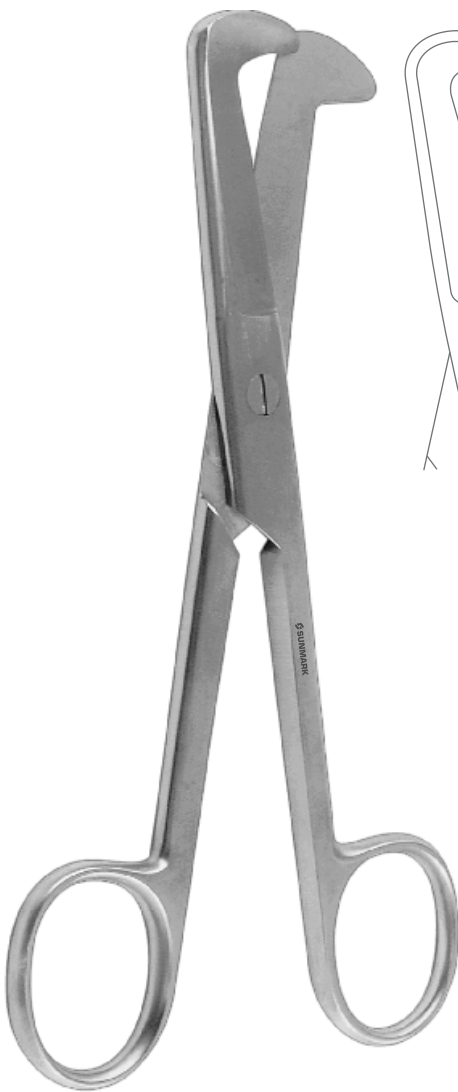

77-387-16
Schumacher Umbilical Cord Scissor
Overall Length 16 cm (6 1/4")

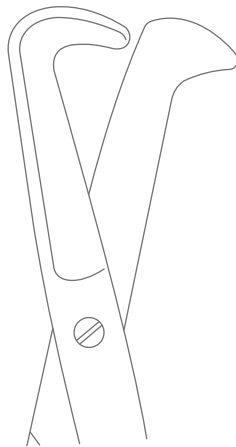

Busch Umbilical Cord Scissor
Overall Length 16 cm (6 1/4")



77-389-16
Curved



77-391-16
One Toothed
Cutting Edge

Gum Scissors
Zahnfleischscheren
Tijeras para encías
Ciseaux à gencives
Forbici per gengiva



77-400-13
Straight



77-400-13
Straight

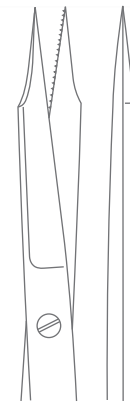
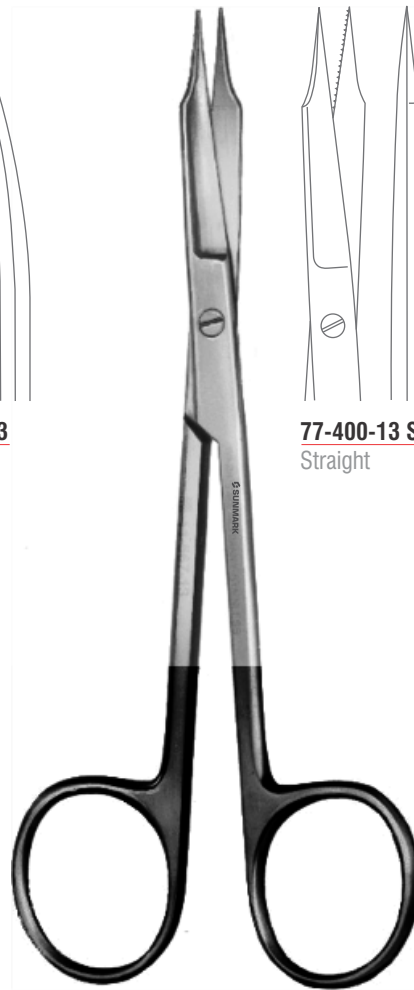

77-400-13 SC
Straight



77-400-13 SC
Straight

Goldman-Fox Gum Scissor
One Toothed Cutting Edge
Overall Length 13 cm (5")

SuperEdge™ Goldman-Fox Gum Scissor
One Toothed Cutting Edge
Overall Length 13 cm (5")

SUPEREdge™

Operating Scissors
Chirurgische Scheren
Tijeras quirúrgicas
Ciseaux chirurgicaux
Forbici per chirurgia

77

SCISSORS



77-402-12
Straight



77-403-12
Curved



77-402-12 SC
Straight



77-403-12 SC
Curved

SUPEREdge™

Wagner Operating Scissor
Overall Length 12 cm (4 ¾")

SuperEdge™ Wagner Operating Scissor
Overall Length 12 cm (4 ¾")

Operating Scissors
Chirurgische Scheren
Tijeras quirúrgicas
Ciseaux chirurgicaux
Forbici per chirurgia



Small Model Operating Scissor
Sharp/Blunt
Overall Length 12 cm (4 ¾")

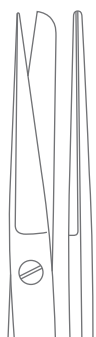

77-406-12
Straight

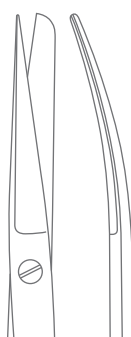

77-407-12
Curved

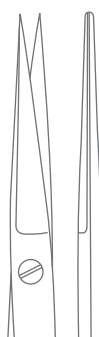

77-408-12
Straight



77-409-12
Curved

Gum Scissors
Zahnfleischscheren
Tijeras para encías
Ciseaux à gencives
Forbici per gengiva

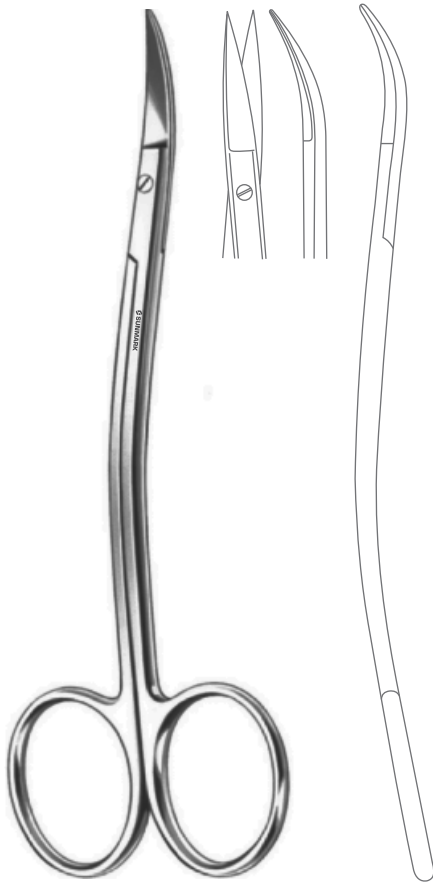

77-411-11
La Grange Gum Scissor
S Shaped
Overall Length 11.5 cm (4 1/2")



77-414-11
Straight

77-415-11
Curved

Delicate Gum Scissor
Overall length 11.5 cm (4 1/2")

Gum Scissors
Zahnfleischscheren
Tijeras para encías
Ciseaux à gencives
Forbici per gengiva



77-417-16
Locklin Gum Scissor
Angled, One Toothed Cutting Edge
Overall Length 16 cm (6 1/4")

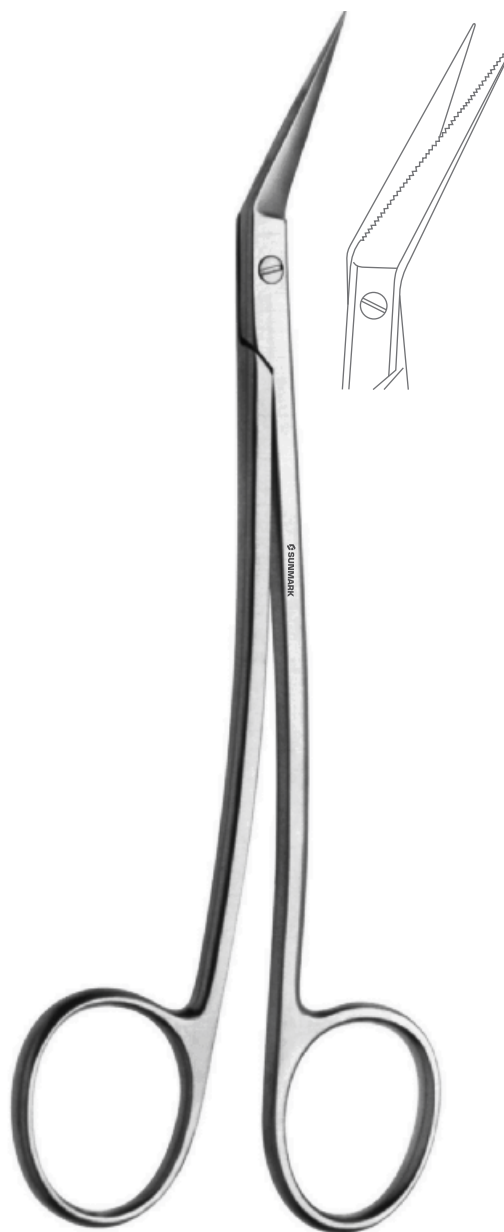

77-419-16
Locklin Gum Scissor
Angled, S Shaped
One Toothed Cutting Edge
Overall Length 16 cm (6 1/4")

Operating Scissors, Iris Scissors
 Chirurgische Scheren, Irisscheren
 Tijeras quirúrgicas, Tijeras para iridectomía
 Ciseaux chirurgicaux, Ciseaux à iridectomie
 Forbici per chirurgia, Forbici per iridectomia



77-422-09
 Straight



77-423-09
 Curved

Very Delicate Operating Scissor

Overall Length 9 cm (3 1/2")



77-430-09
 Straight
 9 cm (3 1/2")



77-430-10
 Straight
 10 cm (4")



77-431-09
 Curved
 9 cm (3 1/2")



77-431-10
 Curved
 10 cm (4")

Iris Scissor



77-432-10
Iris Scissor
 With Extra Flat Blades
 Overall Length 10 cm (4")

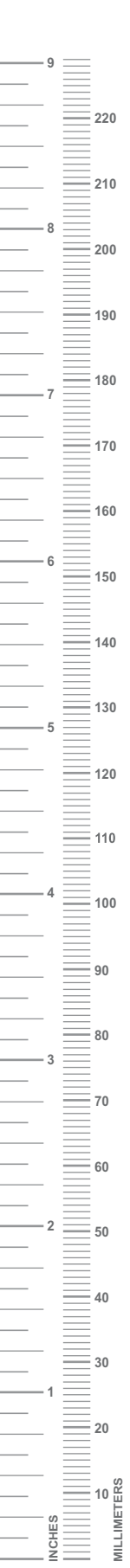

Iris Scissors
Irisscheren
Tijeras para iridectomía
Ciseaux à iridectomie
Forbici per iridectomia



Bonn Iris Scissor
Overall Length 9 cm (3 1/2")



77-434-09
Straight



77-435-09
Curved



77-436-12
Delicate Dissecting Scissor
Straight, With One Ball Tip
Overall Length 12 cm (4 3/4")



Iris Scissor
Overall Length 11.5 cm (4 1/2")



77-440-11
Straight



77-441-11
Curved



SuperEdge™ Iris Scissor
Overall Length 11.5 cm (4 1/2")



77-440-11 SC
Straight



77-441-11 SC
Curved

SUPEREdge™

Iris Scissors
Irisscheren
Tijeras para iridectomía
Ciseaux à iridectomie
Forbici per iridectomia

SCISSORS

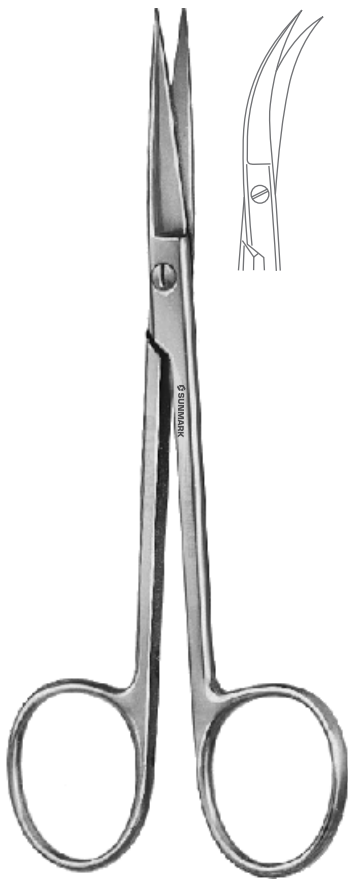

77-443-11
Iris Scissor
Curved to Side
Overall Length 11.5 cm (4 ½")

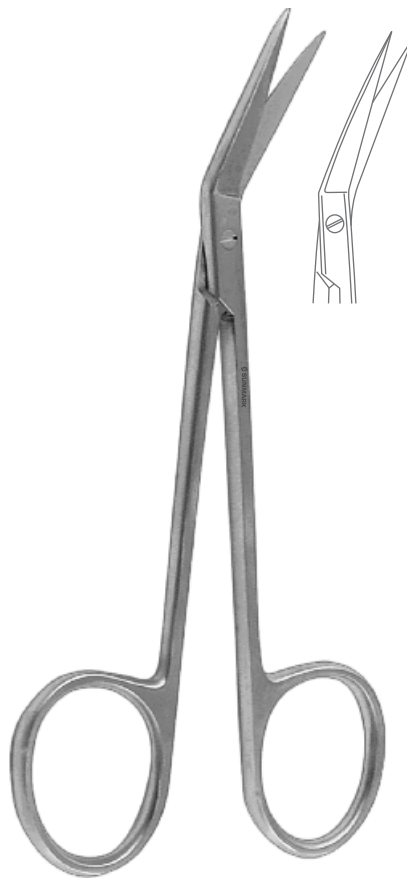

77-445-11
Iris Scissor
Angled
Overall Length 11.5 cm (4 ½")

Iris Scissors
 Irisscheren
 Tijeras para iridectomía
 Ciseaux à iridectomie
 Forbici per iridectomia



77-446-12
Straight

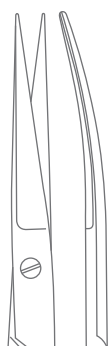

77-447-12
Curved



77-446-12 SC
Straight

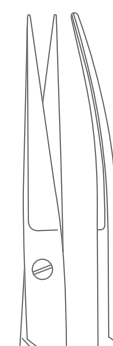

77-447-12 SC
Curved

SUPEREdge™

Iris Scissor
Overall Length 12.5 cm (5")

SuperEdge™ Iris Scissor
Overall Length 12.5 cm (5")

Tendon Scissors
Sehnenscheren
Tijeras para tendones
Ciseaux à ténatomie
Forbici per tenotomia



Stevens Tenotomy Scissor
Sharp/Sharp



77-450-10
Straight
10 cm (4")

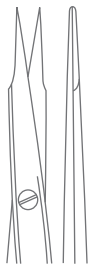

77-450-11
Straight
11 cm (4 1/2")



77-451-10
Curved
10 cm (4")



77-451-11
Curved
11 cm (4 1/2")



SuperEdge™ Stevens Tenotomy Scissor
Sharp/Sharp



77-450-10 SC
Straight
10 cm (4")



77-450-11 SC
Straight
11 cm (4 1/2")



77-451-10 SC
Curved
10 cm (4")



77-451-11 SC
Curved
11 cm (4 1/2")

SUPEREdge™



Tendon Scissors
Sehnenscheren
Tijeras para tendones
Ciseaux à ténatomie
Forbici per tenotomia



Stevens Tenotomy Scissor
Blunt/Blunt



77-452-10
Straight
10 cm (4")

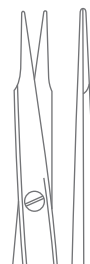

77-452-11
Straight
11 cm (4 1/2")



77-452-12
Straight
12.5 cm (5")



77-453-10
Curved
10 cm (4")



77-453-11
Curved
11 cm (4 1/2")



77-453-12
Curved
12.5 cm (5")

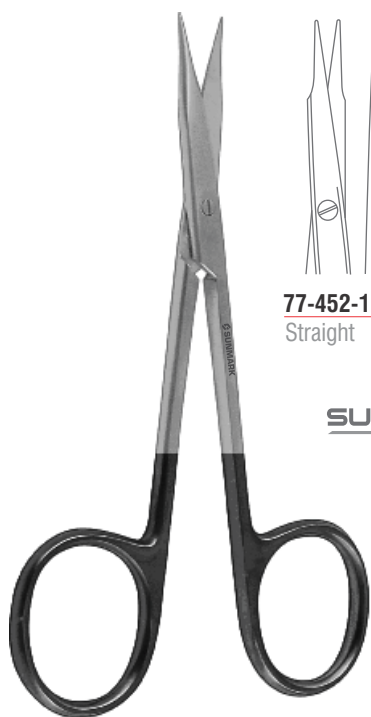

SuperEdge™ Stevens Tenotomy Scissor
Blunt/Blunt
Overall Length 11 cm (4 1/2")

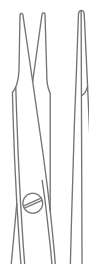

77-452-11 SC
Straight



77-453-11 SC
Curved

SUPEREdge™

Strabismus Scissors
Strabismusscheren
Tijeras para estrabismo
Ciseaux à strabisme
Forbici per strabismo

77

SCISSORS

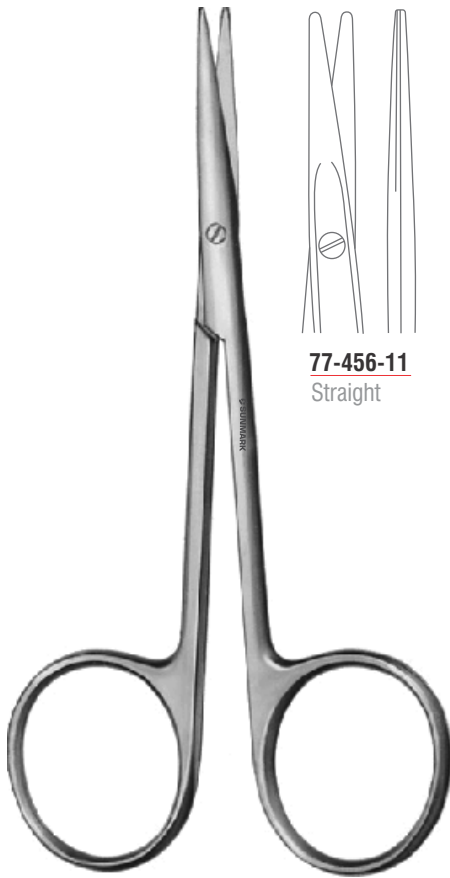

Strabismus Scissor
Overall Length 11.5 cm (4 1/2")

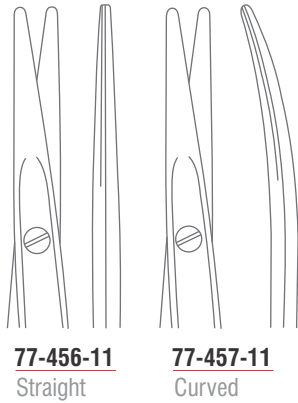

SuperEdge™ Strabismus Scissor
Overall Length 11.5 cm (4 1/2")

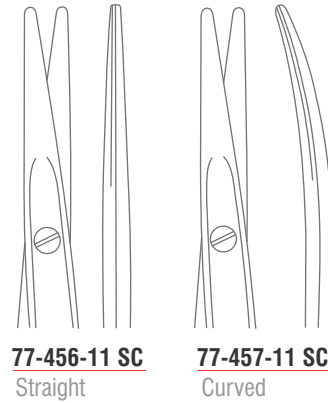

SUPEREdge™

Dissecting Scissors
Präparierscheren
Tijeras de disección
Ciseaux à dissection
Forbici per dissezione



77-459-11
Werbs DCR Scissor
Angled Shaft
Overall Length 11.5 cm (4 ½")

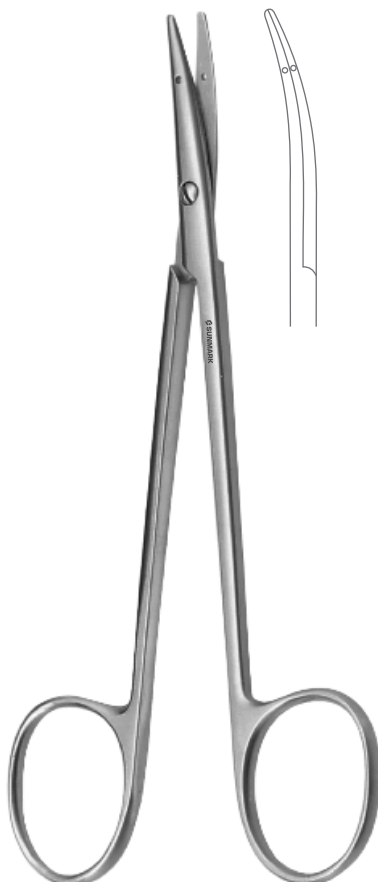

77-461-11
Littler Dissecting Scissor
Curved, Tip With Eye For Suture
Overall Length 11.5 cm (4 ½")



77-463-11
Cottle Bulldog Scissor
Curved
Overall Length 11.5 cm (4 ½")

Dissecting Scissors
 Präparierscheren
 Tijeras de disección
 Ciseaux à dissection
 Forbici per dissezione

77

SCISSORS



77-466-11
Straight



77-467-11
Curved

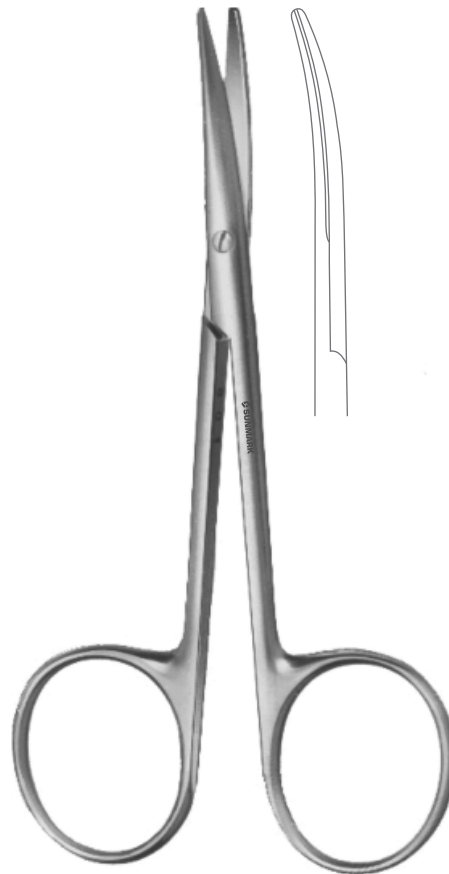

77-469-11
Enucleation Scissor
Curved
Overall Length 11.5 cm (4 1/2")

Dissecting Scissors
 Präparierscheren
 Tijeras de disección
 Ciseaux à dissection
 Forbici per dissezione

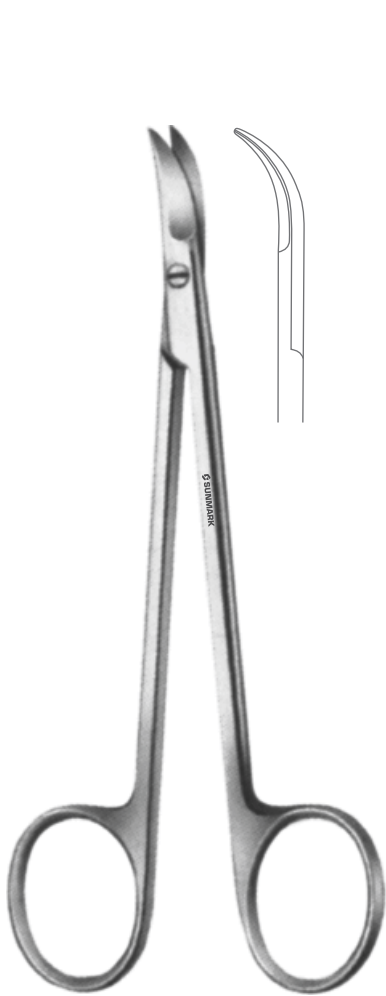

77-471-11
Chadwick Delicate Scissor
 Curved
 Overall Length 11.5 cm (4 ½")

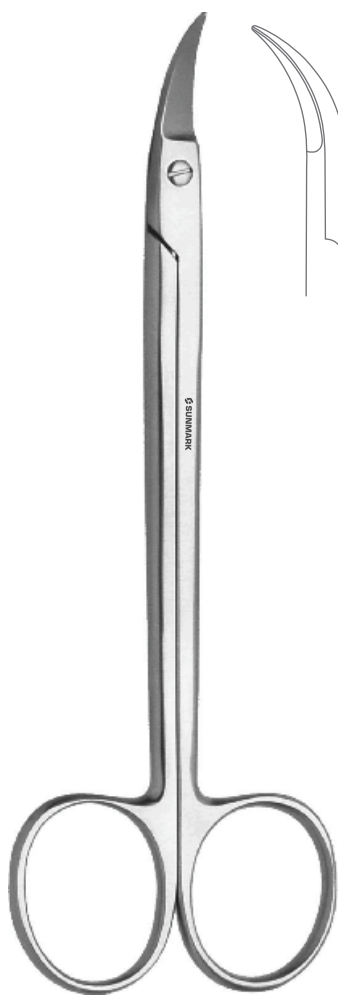

77-473-13
Quimby Delicate Scissor
 Curved
 Overall Length 13 cm (5")



77-475-09
O'Brien Stitch Scissor
 Angled
 Overall Length 9.5 cm (3 ¾")

Dissecting Scissors
Präparierscheren
Tijeras de disección
Ciseaux à dissection
Forbici per dissezione

77

SCISSORS



Quimby Dissecting Scissor



77-476-11
Straight
11 cm (4 1/2")



77-476-13
Straight
13 cm (5")

77-477-11
Curved
13 cm (5")

77-477-13
Curved
13 cm (5")



77-481-11
Delicate Scissor
Angled to side
11.5 cm (4 1/2")



Ribbon Ophthalmic Scissors
Band-Augenschere
Tijera oftálmica de cinta
Ciseaux ophtalmiques à ruban
Forbici oftalmica a nastro



77-484-09
Salyer Ribbon Scissor
Straight, Flat Shanks
Overall Length 9.5 cm (3 3/4")



Iris Scissor (Ribbon Type)
Overall Length 9.5 cm (3 3/4")

77-486-09
Straight, Sharp, Flat Shanks

77-487-09
Curved, Sharp, Flat Shanks



Iris Scissor (Ribbon Type)
Overall Length 10 cm (4")

77-488-10
Straight, Blunt, Flat Shanks

77-489-10
Curved, Blunt, Flat Shanks



Strabismus Scissor (Ribbon Type)
Overall Length 10 cm (4")

77-492-10
Straight, Flat Shanks

77-493-10
Curved, Flat Shanks

Ribbon Ophthalmic Scissors
Band-Augenschere
Tijera oftálmica de cinta
Ciseaux ophtalmiques à ruban
Forbici oftalmica a nastro



Stevens Tenotomy Scissor (Ribbon Type)
Overall Length 10 cm (4")

77-496-10

Straight, Flat Shanks, Sharp Tips

77-497-10

Curved, Flat Shanks, Sharp Tips

77-498-10

Straight, Flat Shanks, Blunt Tips

77-499-10

Curved, Flat Shanks, Blunt Tips



Gradle Scissor (Ribbon Type)
Overall Length 10 cm (4")

77-500-10

Straight, Flat Shanks

77-501-10

Curved, Flat Shanks



77-507-11
Kaye Facelift Scissor (Ribbon Type)

Curved, Flat Shanks, Toothed
Overall Length 11 cm (4 ½")

Rectal Scissors
 Rektumschere
 Tijera para recto
 Ciseaux pour rectum
 Forbici per il retto



77-520-21
Enterotomy Scissor
 One Probe Tip
 Overall Length 21.5 cm (8 1/2")

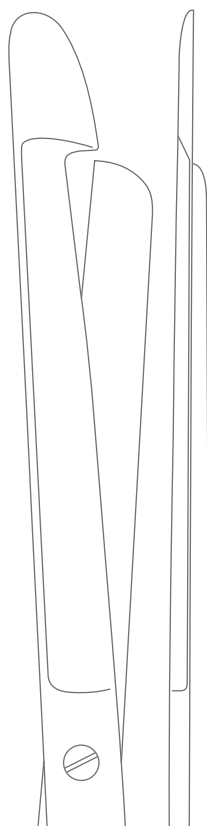

77-522-21
Enterotomy Scissor
 One Probe Tip
 Overall Length 21.5 cm (8 1/2")

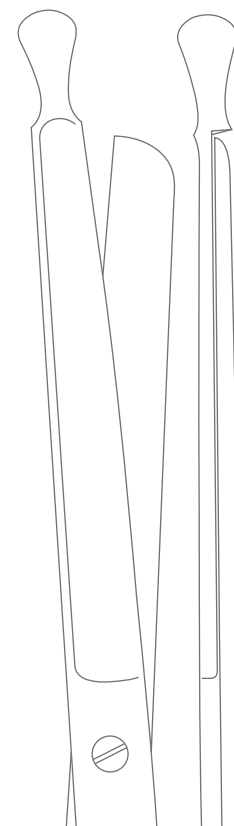

Rectal Scissors
 Rektumschere
 Tijera para recto
 Ciseaux pour rectum
 Forbici per il retto

77

SCISSORS



77-525-32
Rectal Scissor
 Curved Heavy Pattern
 Overall Length 32.5 cm (12 3/4")



77-527-28
Rectal Scissor
 Angled 60°
 Overall Length 28 cm (11")



Rectal Scissors
 Rektumschere
 Tijera para recto
 Ciseaux pour rectum
 Forbici per il retto



77-529-27
Lloyd-Davies Goligher Rectal Scissor
 Curved
 Overall Length 27 cm (10 3/4")

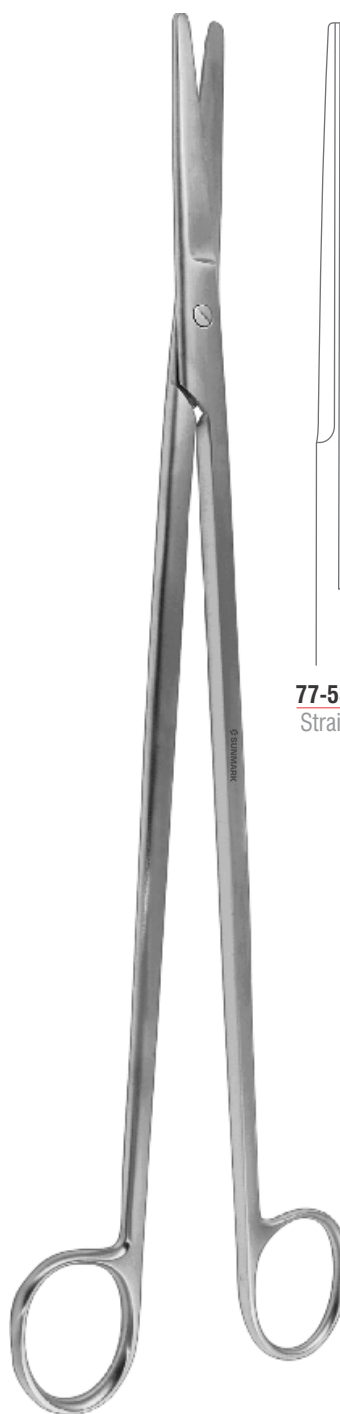

Stelzner Rectal Scissor
 Overall Length 31 cm (12 1/4")

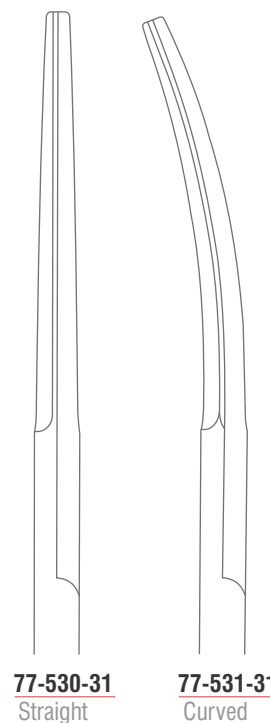

77-530-31
 Straight

77-531-31
 Curved

Rectal Scissors, Stitch Scissors
 Rektumschere, Fadenscheren
 Tijera para recto, Tijeras para hilos
 Ciseaux pour rectum, Ciseaux à ligatures
 Forbici per il retto, Forbici per legature

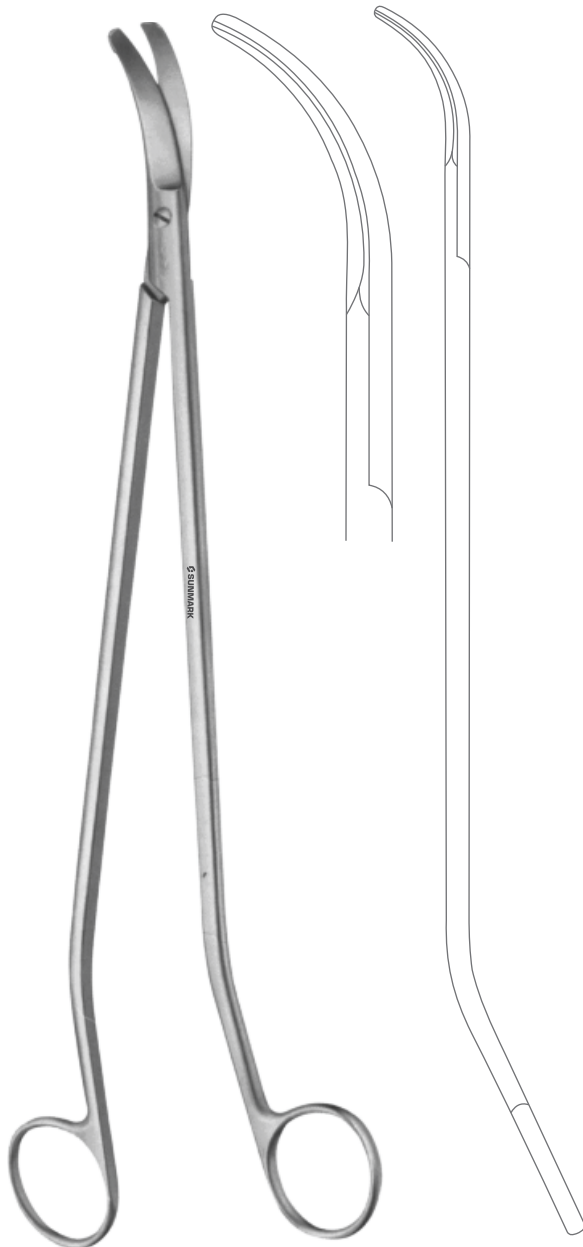

77-533-32
Mueller Rectal Scissor
 S Shaped
 Overall Length 32.5 cm (12 3/4")

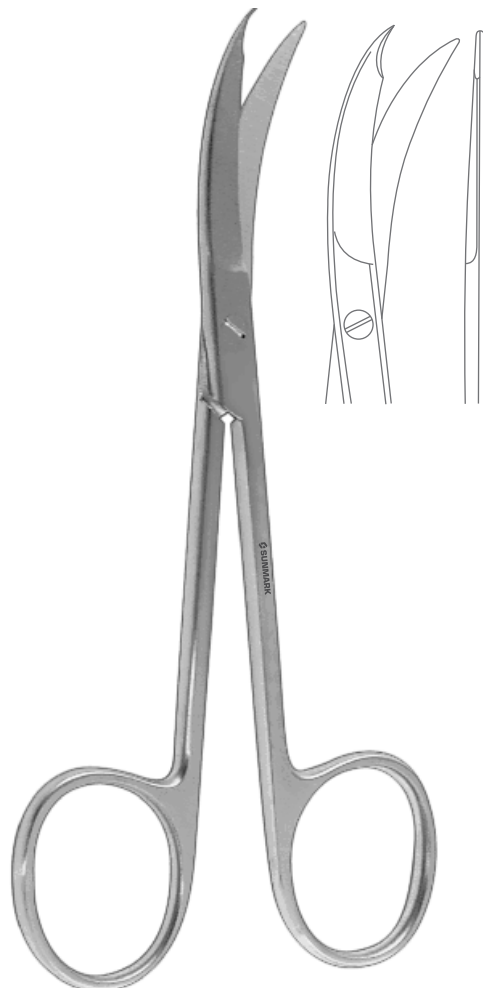

77-540-13
Northbent Stitch Scissor
 Overall Length 13 cm (5")

Stitch Scissors
Fadenscheren
Tijeras para hilos
Ciseaux à ligatures
Forbici per legature



Spencer Stitch Scissor

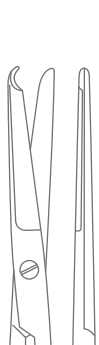

77-542-09
9 cm (3 1/2")

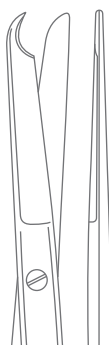

77-542-13
13 cm (5")



Buck Stitch Scissor



77-544-14
14.5 cm (5 3/4")

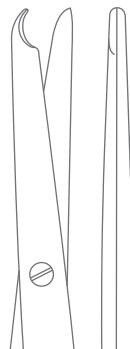

77-544-18
18 cm (7")

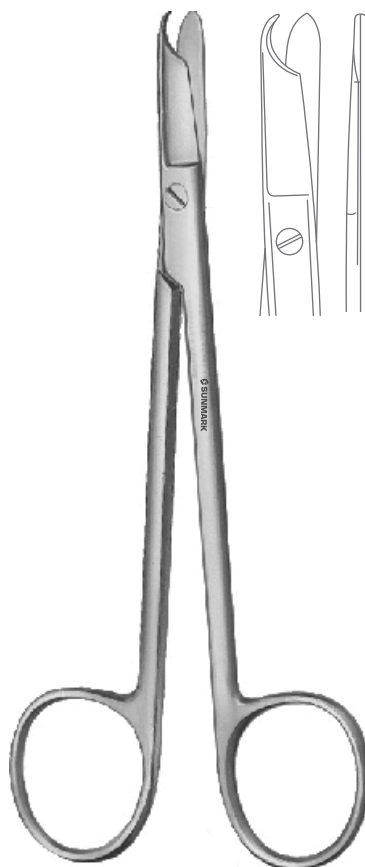

77-546-14
Littauer Stitch Scissor
Overall Length 14 cm (5 1/2")

Stitch Scissors
Fadenscheren
Tijeras para hilos
Ciseaux à ligatures
Forbici per legature

77

SCISSORS



77-548-12
Eiselberg Stitch Scissor
Overall Length 12 cm (4 3/4")

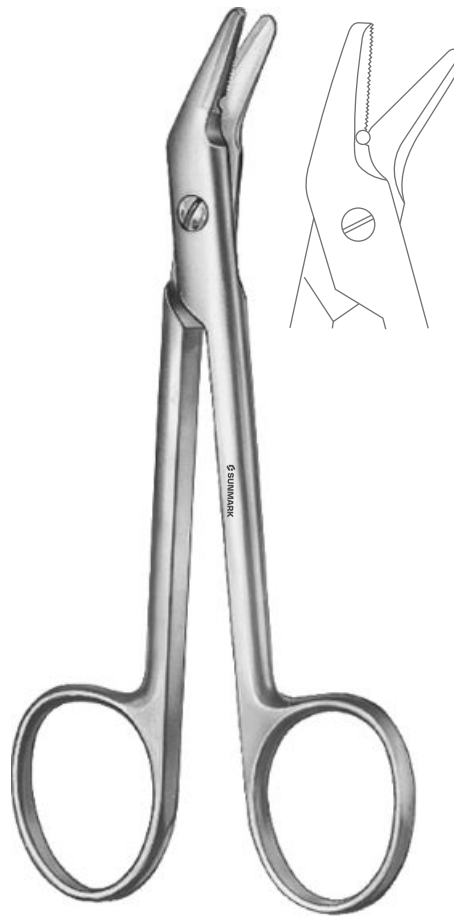

77-551-12
Universal Wire Cutting Scissor
Angled, One Toothed Cutting Edge
Overall Length 12 cm (4 3/4")

Wire Cutting Scissors
 Drahtscheren
 Tijeras para cortar hilos de acero
 Ciseaux coupe-fil
 Forbici per tagliare fili metallic



77-553-12
Heath Suture Scissor
 One Toothed Cutting Edge
 Overall Length 16 cm (6 1/4")



77-554-12
Harvey Wire Cutting Scissor
 Straight, One Toothed Cutting Edge
 Overall Length 12.5 cm (5")

Crown Scissors, Nail Scissors
 Kronenscheren, Nagelscheren
 Tijeras para coronas, Tijeras para uñas
 Ciseaux à couronnes, Ciseaux à ongles
 Forbici per corone, Forbici per unghie



Beebe Crown Scissor



77-556-10
 Straight
 10.5 cm (4 1/4")



77-557-10
 Curved
 10.5 cm (4 1/4")

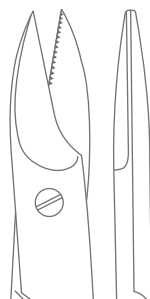

77-558-12
 Straight
 12 cm (4 3/4")

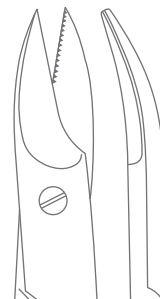

77-559-12
 Curved
 12 cm (4 3/4")



77-571-09
Nail Scissor
 Curved
 Overall Length 9 cm (3 1/2")



77-573-09
Nail Scissor
 Curved, Delicate Pattern
 Overall Length 9 cm (3 1/2")

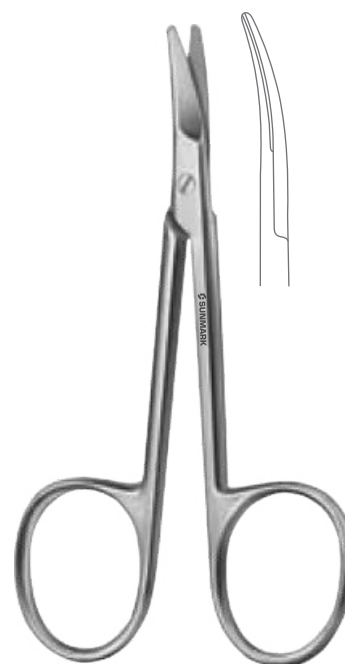







77-575-09
Nail Scissor
 Curved
 Overall Length 8.5 cm (3 1/4")

Nail Scissors
 Nagelscheren
 Tijeras para uñas
 Ciseaux à ongles
 Forbici per unghie



Nail Scissor

			
77-576-09 Straight 9 cm (3 1/2")	77-577-09 Curved 9 cm (3 1/2")	77-577-09 Curved 10 cm (4")	77-577-09 Curved 11 cm (4 1/2")
			
77-577-09 Straight 9.5 cm (3 3/4")	77-579-09 Curved 9.5 cm (3 3/4")	77-579-10 Curved 9.5 cm (3 3/4")	

Bandage Scissors
Verbandscheren
Tijeras para vendajes
Ciseaux pour pansements
Forbici per bendaggi

77

SCISSORS



Smith (Mod. USA) Bandage Scissor
One Large Ring



77-582-18
18 cm (7")



77-582-20
20 cm (8")



77-583-23
23 cm (9")

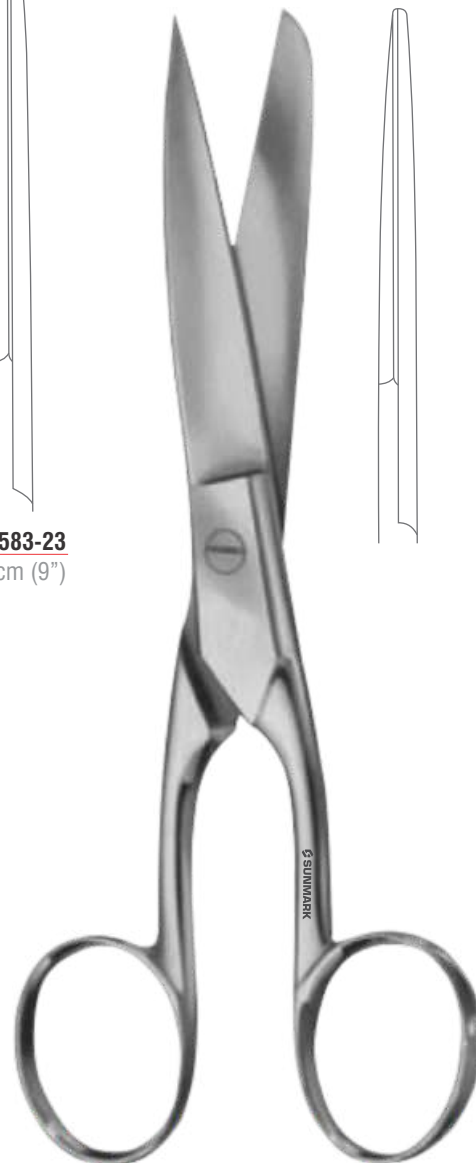
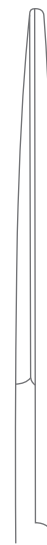

77-584-15
Bandage Scissor
Straight
Overall Length 15 cm (6")

Bandage Scissors
Verbandscheren
Tijeras para vendajes
Ciseaux pour pansements
Forbici per bendaggi

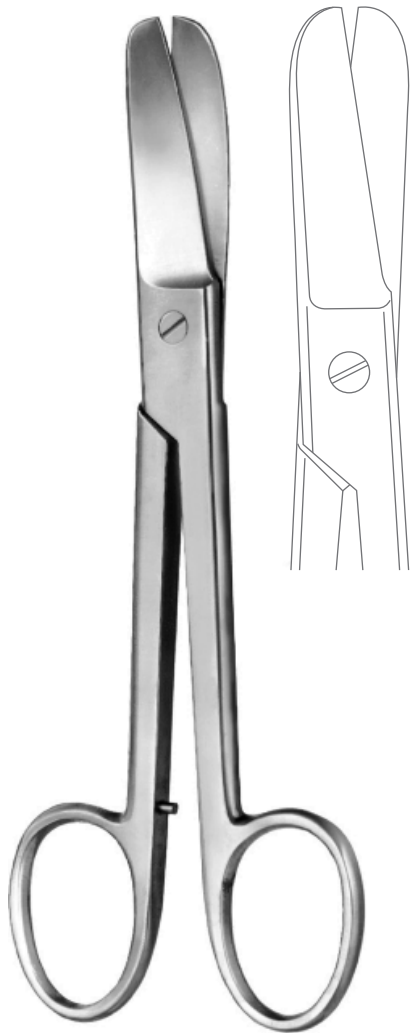

77-585-23
Lorenz Bandage Scissor
Heavy Pattern
Overall Length 23 cm (9")



77-587-14
Knowles Bandage Scissor
Angled
Overall Length 14 cm (5 1/2")

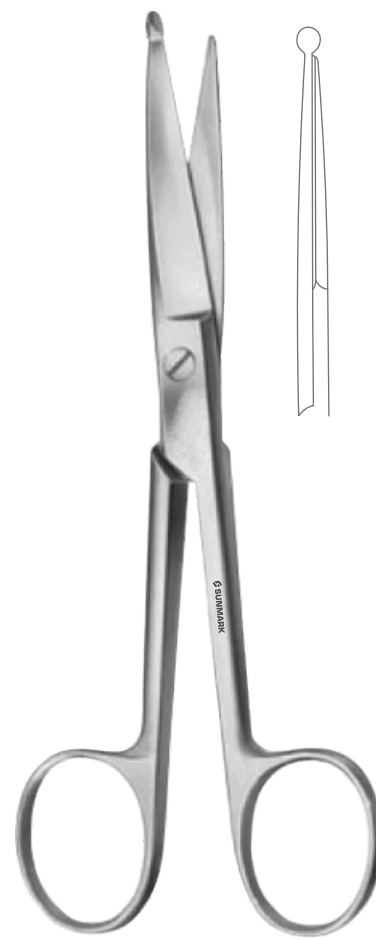

77-588-14
Knowles Bandage Scissor (For Fingers)
Straight
Overall Length 14 cm (5 1/2")

Bandage Scissors
 Verbandscheren
 Tijeras para vendajes
 Ciseaux pour pansements
 Forbici per bendaggi



77-591-14
 14.5 cm (5 3/4")
77-591-18
 18.5 cm (7 1/4")
77-591-20
 20 cm (8")

Lister Bandage Scissor



77-593-18 **77-593-21**

Lister Bandage Scissor
 One Large Ring
 Overall Length 18.5 cm (7 1/4")

Bandage Scissors
Verbandscheren
Tijeras para vendajes
Ciseaux pour pansements
Forbici per bendaggi



Lister (Eccentric) Bandage Scissor
One Toothed Cutting Edge

77-595-16
16 cm (6 1/4")

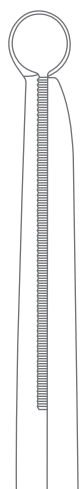

77-595-19
19 cm (7 1/2")



77-597-23
Bergmann Bandage Scissor
Heavy Pattern
Overall Length 23.5 cm (9 1/4")

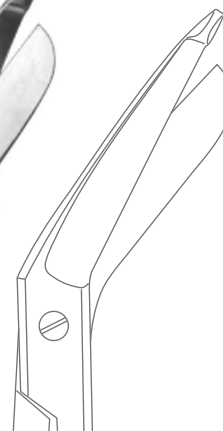

Esmarch Bandage Scissor
Heavy Pattern, Short Blades

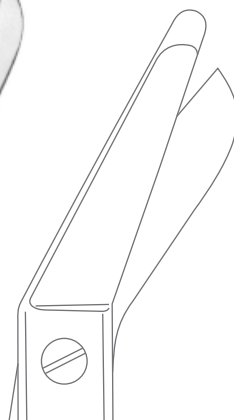

77-599-20
20 cm (8")

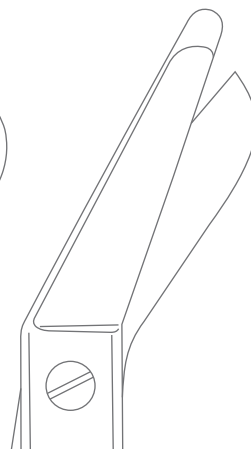

77-599-23
23 cm (9")

Bandage Scissors
 Verbandscheren
 Tijeras para vendajes
 Ciseaux pour pansements
 Forbici per bendaggi



Universal Bandage Scissor
 Plastic Handle

Codes	Size	Handle Colour
<u>77-601-14</u>	14.5 cm (5 ¾")	Black
<u>77-601-16</u>	16 cm (6 ¼")	Black
<u>77-601-18</u>	18 cm (7 ½")	Black
<u>77-603-14</u>	14.5 cm (5 ¾")	Blue
<u>77-603-16</u>	16 cm (6 ¼")	Blue
<u>77-603-18</u>	18 cm (7 ½")	Blue
<u>77-605-14</u>	14.5 cm (5 ¾")	Red
<u>77-605-16</u>	16 cm (6 ¼")	Red
<u>77-605-18</u>	18 cm (7 ½")	Red
<u>77-607-14</u>	14.5 cm (5 ¾")	Green
<u>77-607-16</u>	16 cm (6 ¼")	Green
<u>77-607-18</u>	18 cm (7 ½")	Green



Plaster Shears
Gipsscheren
Tijeras para yeso
Ciseaux pour plâtre
Forbici per gesso



77-609-23
Seutin Plaster of Paris Shear
Overall Length 23 cm (9")



77-611-20
Seutin Plaster of Paris Shear
One Toothed Cutting Edge
Overall Length 20 cm (8")

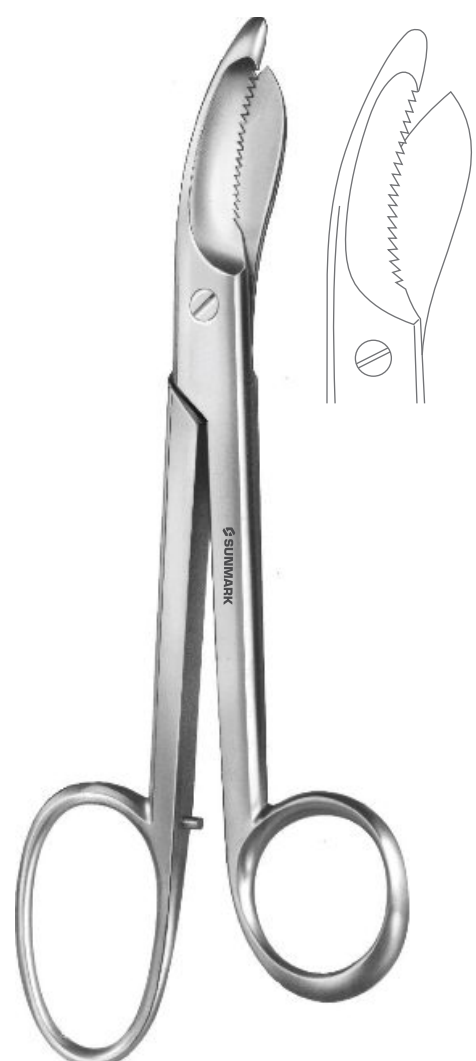

77-613-24
Bruns Plaster of Paris Shear
One Toothed Cutting Edge
Overall Length 24 cm (9 1/2")

Micro Scissors
Mikroscheren
Micro-Tijeras
Micro-Ciseaux
Micro-Forbici



77-620-01
Straight
Blunt/Blunt

77-620-02
Straight
Sharp/Blunt

77-620-03
Straight
Sharp/Sharp

Mueller Micro Scissor

Round Handle
Overall Length 12 cm (4 3/4")



77-621-01
Curved
Blunt/Blunt

77-621-02
Curved
Sharp/Blunt

77-621-03
Curved
Sharp/Sharp

Mueller Micro Scissor

Round Handle
Overall Length 12 cm (4 3/4")



77-622-01
Straight
Blunt/Blunt

77-622-02
Straight
Sharp/Blunt

77-622-03
Straight
Sharp/Sharp

Mueller Micro Scissor

Round Handle
Overall Length 15 cm (6")



77-623-01
Curved
Blunt/Blunt

77-623-02
Curved
Sharp/Blunt

77-623-03
Curved
Sharp/Sharp

Mueller Micro Scissor

Round Handle
Overall Length 15 cm (6")

Micro Scissors
Mikroscheren
Micro-Tijeras
Micro-Ciseaux
Micro-Forbici

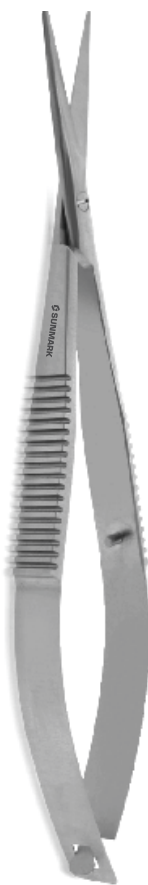

77-626-01
Williamson-Noble Micro Scissor
Straight, Sharp/Sharp 27 mm Long Blades With
Max. 14 mm Cutting Edge
Overall Length 11.5 cm (4 3/4")



Noyes Iris Scissor
Sharp/Sharp, 23 mm Long Blades
with Max. 14 mm Cutting Edge
Overall Length 12.5 cm (5")



77-630-12
Straight

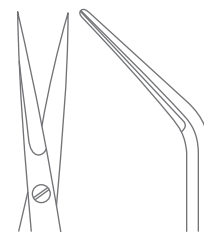

77-631-12
Curved

Bandage Scissors
Verbandscheren
Tijeras para vendajes
Ciseaux pour pansements
Forbici per bendaggi

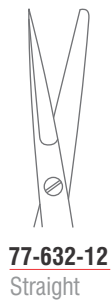

77-632-12
Straight

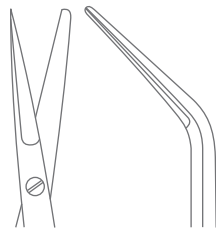

77-633-12
Curved

Noyes Iris Scissor

Sharp/Blunt
23 mm Long Blades With Max. 14 mm Cutting Edge
Overall Length 12.5 cm (5")

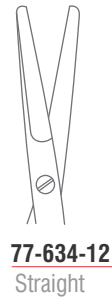

77-634-12
Straight

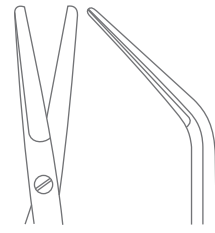

77-635-12
Curved

Noyes Iris Scissor

Blunt/Blunt
23 mm Long Blades With Max. 14 mm Cutting Edge
Overall Length 12.5 cm (5")





Micro Scissors
Mikroscheren
Micro-Tijeras
Micro-Ciseaux
Micro-Forbici



77-636-12
Straight

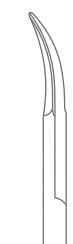

77-637-12
Curved

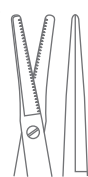

77-638-10
Osher IOL Cutting Scissor
Straight
Micro Serrated Cutting Edge With
Blunt Tip 10 mm Long Blades With
Max. 5 mm Cutting Edge
Overall Length 10 cm (4")



77-639-10
Osher IOL Cutting Scissor
Angled
Micro Serrated Cutting Edge With
Blunt Tip 10 mm Long Blades With
Max. 5 mm Cutting Edge
Overall Length 10 cm (4")

Plaster Shears
Gipsscheren
Tijeras para yeso
Ciseaux pour plâtre
Forbici per gesso

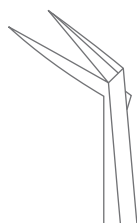

77-641-11
Angled
Sharp/Sharp

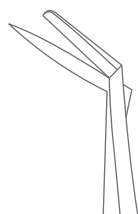

77-643-11
Angled
Sharp/Blunt

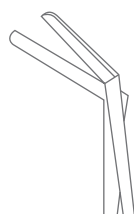

77-645-11
Angled
Blunt/Blunt

Wecker Iris Scissor

8 mm Long Blades With Max. 5 mm Cutting Edge
Overall Length 11 cm (4 ½")



77-647-05
Angled, 5 mm

77-647-07
Angled, 7 mm

77-647-10
Angled, 10 mm

Barraquer Iris Scissor

9 mm Long Blades Max. 6 mm Cutting Edge
Overall Length 5.5 cm (2 ¼")





Micro Scissors
Mikroscheren
Micro-Tijeras
Micro-Ciseaux
Micro-Forbici



77-649-01
Curved Right

77-649-02
Curved Left

Holland DALK Scissor
Blunt Tips With Spatulated Inner Blade
8 mm Long Blades With
Max. 4 mm Cutting Edge
Overall Length 10.5 cm (4")



Castroviejo Corneoscleral Scissor
8 mm Long Blades With
Max. 4 mm Cutting Edge
Overall Length 10.5 cm (4")

77-651-01
Curved Right

77-651-02
Curved Left



Castroviejo Corneoscleral Scissor
12 mm Long Blades With
Max. 7 mm Cutting Edge
Overall Length 11 cm (4")

77-653-01
Curved Right

77-653-02
Curved Left

Micro Scissors
Mikroscheren
Micro-Tijeras
Micro-Ciseaux
Micro-Forbici

77

SCISSORS



Troutman-Castroviejo Corneoscleral Scissor
With Lock
8 mm Long Blades With Max. 4 mm Cutting Edge
Overall Length 10.5 cm (4")

77-655-01
Curved Right
77-655-02
Curved Left



Troutman-Castroviejo Corneoscleral Scissor
With Lock
12 mm Long Blades With Max. 7 mm Cutting Edge
Overall Length 11 cm (4 ½")

77-657-01
Curved Right
77-657-02
Curved Left





Micro Scissors
Mikroscheren
Micro-Tijeras
Micro-Ciseaux
Micro-Forbici



Troutman-Katzin Corneal Transplant Scissor
Strongly Curved, With Lock
8 mm Long Blades With Max. 4 mm Cutting Edge
Overall Length 10.5 cm (4")

- 77-659-01**
Curved Right
- 77-659-02**
Curved Left



Katzin Corneal Transplant Scissor
Strongly Curved
13 mm Long Blades With Max. 7 mm Cutting Edge
Overall Length 11 cm (4 1/2")

- 77-661-01**
Curved Right
- 77-661-02**
Curved Left

Micro Scissors
Mikroscheren
Micro-Tijeras
Micro-Ciseaux
Micro-Forbici

77

SCISSORS



Castroviejo Universal Corneal Scissor

Curved, Blunt Tips
Overall Length 11 cm (4 1/2")

77-663-11

10 mm Long Blades With
Max. 5 mm Cutting Edge

77-665-11

12 mm Long Blades With
Max. 6 mm Cutting Edge

77-667-11

14 mm Long Blades With
Max. 8 mm Cutting Edge



77-669-11

Castroviejo Universal Corneal Scissor

Strongly Curved, Blunt Tips 15 mm Long Blades With
Max. 9 mm Cutting Edge
Overall Length 11.5 cm (4 1/2")





Micro Scissors
Mikroscheren
Micro-Tijeras
Micro-Ciseaux
Micro-Forbici



77-671-11
Castroviejo Keratoplasty Scissor
Angled to Side, Blunt Tips
14 mm Long Blades With
Max. 9 mm Cutting Edge
Overall Length 11.5 cm (4 1/2")



77-673-11
McPherson-Westcott Conjunctival Scissor
Curved, Blunt Tips
10 mm Long Blades With
Max. 5 mm Cutting Edge
Overall Length 11 cm (4 1/2")



77-675-11
Westcott Tenotomy Scissor
Curved, Blunt Tips
14 mm Long Blades With
Max. 8 mm Cutting Edge
Overall Length 11 cm (4 1/2")

Micro Scissors
 Mikroscheren
 Micro-Tijeras
 Micro-Ciseaux
 Micro-Forbici



Westcott Tenotomy Scissor

Blunt Tips
 20 mm Long Blades With
 Max. 10 mm Cutting Edge
 Overall Length 11 cm (4 ½")

77-677-01

Curved Right

77-677-02

Curved Left



77-679-11

Tibolt Punctal Scissor

One Conically Shaped Blade With
 Micro Grooves & Textured Surface
 15 mm Long Blades With
 Max. 8 mm Cutting Edge
 Overall Length 11.5 cm (4 ½")



77-681-11

McPherson-Westcott Stitch Scissor

Curved, Very Sharp Pointed Tips, Small Blades
 10 mm Long Blades With
 Max. 5 mm Cutting Edge
 Overall Length 11 cm (4 ½")

Micro Scissors
 Mikroscheren
 Micro-Tijeras
 Micro-Ciseaux
 Micro-Forbici



77-683-11
Westcott Stitch Scissor
 Curved, Very Sharp Pointed Tips
 20 mm Long Blades With
 Max. 10 mm Cutting Edge
 Overall Length 11.5 cm (4 1/2")



77-685-11
Jaffe Stitch Scissor
 Curved, Very Sharp Pointed Tips
 13 mm Long Blades With
 Max. 7 mm Cutting Edge
 Overall Length 11 cm (4 1/2")



77-688-11
Iris Micro Scissor
 Straight, Sharp Tips
 10 mm Long Blades With
 Max. 5 mm Cutting Edge
 Overall Length 11 cm (4 1/2")



77-689-11
Iris Micro Scissor
 Curved, Sharp Tips
 10 mm Long Blades With
 Max. 5 mm Cutting Edge
 Overall Length 11 cm (4 1/2")

Micro Scissors
Mikroscheren
Micro-Tijeras
Micro-Ciseaux
Micro-Forbici

77

SCISSORS



77-690-11
Fine Micro Scissor
Straight, Sharp Tips
17 mm Long Blades With
Max. 9 mm Cutting Edge
Overall Length 11.5 cm (4 ½")



77-691-11
Fine Micro Scissor
Curved, Sharp Tips
17 mm Long Blades With
Max. 9 mm Cutting Edge
Overall Length 11.5 cm (4 ½")

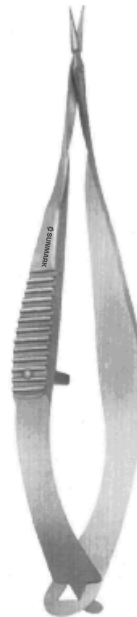

77-694-08
Vannas Capsulotomy Scissor
Straight, Sharp Tips
5 mm Long Blades With
Max. 3 mm Cutting Edge
Overall Length 8 cm (3 ¼")



77-695-08
Vannas Capsulotomy Scissor
Curved, Sharp Tips
5 mm Long Blades With
Max. 3 mm Cutting Edge
Overall Length 8 cm (3 ¼")



Micro Scissors
Mikroscheren
Micro-Tijeras
Micro-Ciseaux
Micro-Forbici



77-696-08
Vannas Capsulotomy Scissor
Angled Forward, Sharp Tips 5 mm Long Blades With
Max. 3 mm Cutting Edge
Overall Length 8 cm (3 1/4")



77-697-08
Vannas Capsulotomy Scissor
Angled to Side, Sharp Tips 5 mm Long Blades With
Max. 3 mm Cutting Edge
Overall Length 8 cm (3 1/4")



77-698-08
Gills-Vannas Capsulotomy Scissor
Straight, Sharp Tips 7 mm Long Blades With
Max. 3 mm Cutting Edge
Overall Length 8 cm (3 1/4")



77-699-08
Gills-Vannas Capsulotomy Scissor
Curved, Sharp Tips 7 mm Long Blades With
Max. 3 mm Cutting Edge
Overall Length 8 cm (3 1/4")

Micro Scissors
 Mikroscheren
 Micro-Tijeras
 Micro-Ciseaux
 Micro-Forbici

77

SCISSORS



77-701-08
Gills-Vannas Capsulotomy Scissor
 Angled Forward, Sharp Tips 7 mm
 Long Blades With Max. 3 mm Cutting Edge
 Overall Length 8 cm (3 1/4")



77-703-08
McPherson-Vannas Capsulotomy Scissor
 Curved, Sharp Tips 8 mm
 Long Blades With Max. 3 mm Cutting Edge
 Overall Length 8 cm (3 1/4")



77-705-08
Holland DALK Scissor
 Angled Blades With Blunt Tips
 5 mm Long Blades With Max. 3 mm
 Cutting Edge
 Overall Length 8 cm (3 1/4")





Micro Scissors
Mikroscheren
Micro-Tijeras
Micro-Ciseaux
Micro-Forbici



77-706-10
Gills-Vannas Micro Scissor
Straight, Extra Thin Blades
Sharp Tips
7 mm Long Blades With
Max. 3 mm Cutting Edge
Overall Length 10.5 cm (4")



77-707-10
Gills-Vannas Micro Scissor
Curved, Extra Thin Blades
Sharp Tips
7 mm Long Blades With
Max. 3 mm Cutting Edge
Overall Length 10.5 cm (4")



77-709-10
Gills-Vannas Micro Scissor
Angled Forward, Extra Thin Blades
Sharp Tips
7 mm Long Blades With
Max. 3 mm Cutting Edge
Overall Length 10.5 cm (4")

Micro Scissors
 Mikroscheren
 Micro-Tijeras
 Micro-Ciseaux
 Micro-Forbici

77

SCISSORS



77-710-11
Stern-Gills Micro Scissor
 Straight, Extra Thin Blades
 Sharp Tips
 10 mm Long Blades With
 Max. 4 mm Cutting Edge
 Overall Length 11 cm (4 ½")



77-711-11
Stern-Gills Micro Scissor
 Curved, Extra Thin Blades
 Sharp Tips
 10 mm Long Blades With
 Max. 4 mm Cutting Edge
 Overall Length 11 cm (4 ½")



77-713-11
Stern-Gills Micro Scissor
 Angled Forward, Extra Thin
 Blades Sharp Tips
 10 mm Long Blades With
 Max. 4 mm Cutting Edge
 Overall Length 11 cm (4 ½")



77-715-11
Gills Capsulotomy Scissor
 Angled Blades With Curved Sharp
 Tips 10 mm Long Blades With
 Max. 4 mm Cutting Edge
 Overall Length 10.5 cm (4 ½")



Micro Scissors
Mikroscheren
Micro-Tijeras
Micro-Ciseaux
Micro-Forbici



Vitrectomy Scissor
Overall Length 14 cm (5 1/2")



77-720-20
Straight
Horizontal Opening
20 G



77-721-20
Curved
Horizontal Opening
20 G



77-721-30
Angled 30°
Horizontal Opening
20 G



77-721-23
Curved
Horizontal Opening
23 G



77-721-45
Angled 45°
Horizontal Opening
20 G



77-723-23
Vertical
Straight, 23 G



77-723-60
Angled 60°
Horizontal Opening
20 G



77-723-80
Angled 80°
Horizontal Opening
20 G

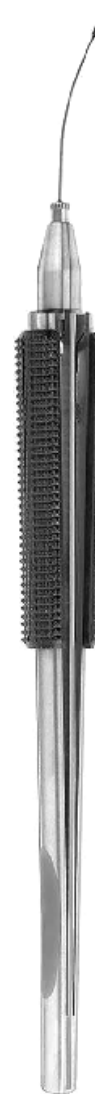

77-725-23
Alio MICS Scissor
Curved, 23 G
Shaft With Horizontal Micro Blades
for Cutting Delicate Membranes
Overall Length 14 cm (5 1/2")

Micro Scissors
Mikroscheren
Micro-Tijeras
Micro-Ciseaux
Micro-Forbici

77

SCISSORS



77-726-12
Vannas Micro Scissor
Straight, 10 mm Long Blades With
Max. 4 mm Cutting Edge
Overall Length 12 cm (4 3/4")



77-727-12
Vannas Micro Scissor
Curved, 10 mm Long Blades With
Max. 4 mm Cutting Edge
Overall Length 12 cm (4 3/4")



77-729-12
Vannas Micro Scissor
Angled on Flat, 10 mm Long Blades With
Max. 4 mm Cutting Edge
Overall Length 12 cm (4 3/4")



Micro Scissors
Mikroscheren
Micro-Tijeras
Micro-Ciseaux
Micro-Forbici



77-730-13
Biemer Vein Scissor
Overall Length 13 cm (5")



Micro Scissor
Overall Length 16 cm (6 1/4")

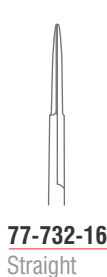

77-732-16
Straight

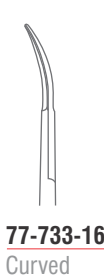

77-733-16
Curved



Vannas Micro Scissor
Overall Length 16 cm (6 1/4")

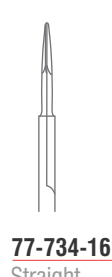

77-734-16
Straight

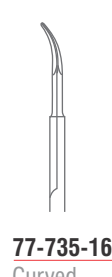

77-735-16
Curved

Micro Scissors
Mikroscheren
Micro-Tijeras
Micro-Ciseaux
Micro-Forbici

77

SCISSORS



77-736-16
Straight



77-737-16
Curved

Millesi Micro Scissor
Serrated
Overall Length 16 cm (6 1/4")



77-738-18
Straight
Yasargil



77-739-18
Curved
Jacobson

Yasargil Micro Scissor
Overall Length 18.5 cm (7 1/4")



77-740-14
Straight
Sharp/Sharp



77-741-14
Curved
Sharp/Sharp



77-743-14
Curved
Blunt/Blunt

Adventitia Micro Scissor
Overall Length 14.5 cm (5 3/4")



Micro Scissors
Mikroscheren
Micro-Tijeras
Micro-Ciseaux
Micro-Forbici



Micro Scissor
Overall Length 16.5 cm (6 1/2")



77-744-16
Straight
Delicate Blades



77-745-16
Curved
Delicate Blades



77-746-16
Straight
Extra Delicate Blades



77-747-16
Curved
Extra Delicate Blades

Micro Scissors
Mikroscheren
Micro-Tijeras
Micro-Ciseaux
Micro-Forbici



Micro Coronary Scissor
Overall Length 18 cm (7")



77-751-25
Angled 25°



77-751-45
Angled 45°



77-751-60
Angled 60°

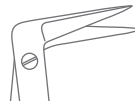

77-751-90
Angled 90°



77-753-00
Angled 125°

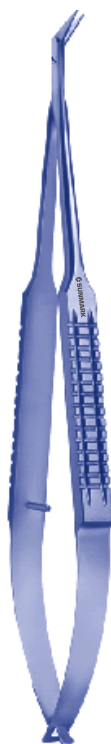

Micro Coronary Scissor
Overall Length 18 cm (7")



77-751-25 T
Angled 25°



77-751-45 T
Angled 45°



77-751-60 T
Angled 60°

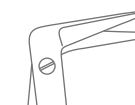

77-751-90 T
Angled 90°



77-753-00 T
Angled 125°



TITANIUM



Micro Coronary Scissor
 Overall Length 16.5 cm (6 1/2")

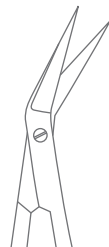

77-755-25
 Fine Blades
 Angled 25°

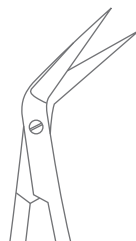

77-755-45
 Fine Blades
 Angled 45°

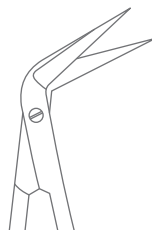

77-755-60
 Fine Blades
 Angled 60°

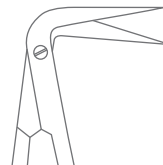

77-755-90
 Fine Blades
 Angled 90°

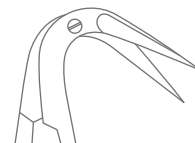

77-757-00
 Fine Blades
 Angled 125°



77-759-25
 Fine Blades
 One Blade
 Probe Tip
 Angled 25°



77-759-45
 Fine Blades
 One Blade
 Probe Tip
 Angled 45°

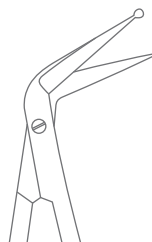

77-759-60
 Fine Blades
 One Blade
 Probe Tip
 Angled 60°

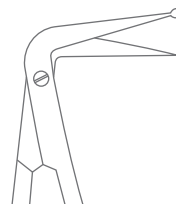

77-759-90
 Fine Blades
 One Blade
 Probe Tip
 Angled 90°

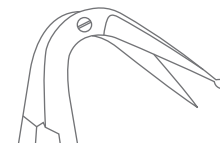

77-761-00
 Fine Blades
 One Blade
 Probe Tip
 Angled 125°



77-763-25
 Delicate
 Blades
 Angled 25°



77-763-45
 Delicate
 Blades
 Angled 45°

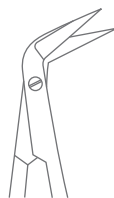

77-763-60
 Delicate
 Blades
 Angled 60°

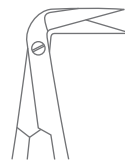

77-763-90
 Delicate
 Blades
 Angled 90°



77-765-00
 Delicate
 Blades
 Angled 125°



77-767-25
 Extra Delicate
 Blades
 Angled 25°



77-767-45
 Extra Delicate
 Blades
 Angled 45°

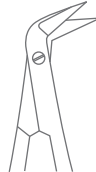

77-767-60
 Extra Delicate
 Blades
 Angled 60°

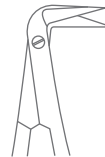

77-767-90
 Extra Delicate
 Blades
 Angled 90°



77-769-00
 Extra Delicate
 Blades
 Angled 125°

Micro Scissors
 Mikroscheren
 Micro-Tijeras
 Micro-Ciseaux
 Micro-Forbici



Micro Coronary Scissor
 Round Handle
 Overall Length 16.5 cm (6 1/2")



77-775-25
 Fine Blades
 Angled 25°



77-775-45
 Fine Blades
 Angled 45°

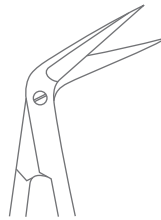

77-775-60
 Fine Blades
 Angled 60°

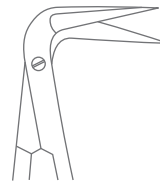

77-775-90
 Fine Blades
 Angled 90°

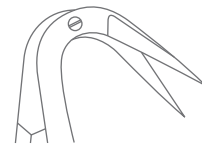

77-777-00
 Fine Blades
 Angled 125°



77-779-25
 Fine Blades
 One Blade
 Probe Tip
 Angled 25°



77-779-45
 Fine Blades
 One Blade
 Probe Tip
 Angled 45°



77-779-60
 Fine Blades
 One Blade
 Probe Tip
 Angled 60°

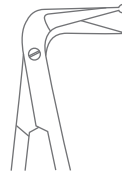

77-779-90
 Fine Blades
 One Blade
 Probe Tip
 Angled 90°



77-781-00
 Fine Blades
 One Blade
 Probe Tip
 Angled 125°



Micro Scissors
 Mikroscheren
 Micro-Tijeras
 Micro-Ciseaux
 Micro-Forbici



Micro Coronary Scissor
 Round Handle
 Overall Length 16.5 cm (6 1/2")



77-783-25
 Delicate
 Blades
 Angled 25°



77-783-45
 Delicate
 Blades
 Angled 45°

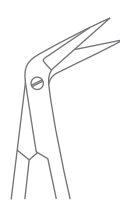

77-783-60
 Delicate
 Blades
 Angled 60°

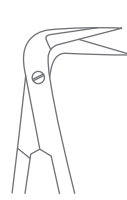

77-783-90
 Delicate
 Blades
 Angled 90°



77-785-00
 Delicate
 Blades
 Angled 125°



77-787-25
 Extra Delicate
 Blades
 Angled 25°

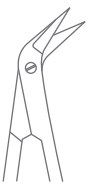

77-787-45
 Extra Delicate
 Blades
 Angled 45°



77-787-60
 Extra Delicate
 Blades
 Angled 60°

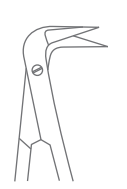

77-787-90
 Extra Delicate
 Blades
 Angled 90°

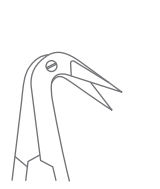

77-789-00
 Extra Delicate
 Blades
 Angled 125°

Micro Scissors
Mikroscheren
Micro-Tijeras
Micro-Ciseaux
Micro-Forbici

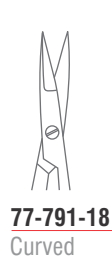

Micro Scissor
Round Handle
Overall Length 18 cm (7")



Micro Scissors
 Mikroscheren
 Micro-Tijeras
 Micro-Ciseaux
 Micro-Forbici



Micro Scissor
 Round Handle



77-800-15
 Straight
 15 cm (6")



77-800-18
 Straight
 18 cm (7")



77-800-21
 Straight
 21 cm (8 1/4")



77-800-23
 Straight
 23 cm (9")



Micro Scissor
 Round Handle



77-800-15 T
 Straight
 15 cm (6")



77-800-18 T
 Straight
 18 cm (7")



77-800-21 T
 Straight
 21 cm (8 1/4")



Micro Scissors
Mikroscheren
Micro-Tijeras
Micro-Ciseaux
Micro-Forbici



Micro Scissor
Round Handle



77-801-15
Straight
15 cm (6")



77-801-18
Straight
18 cm (7")



77-801-21
Straight
21 cm (8 1/4")



77-801-23
Straight
23 cm (9")



Micro Scissor
Round Handle



77-801-15 T
Straight
15 cm (6")



77-801-18 T
Straight
18 cm (7")



77-801-21 T
Straight
21 cm (8 1/4")



TITANIUM



Micro Scissors
 Mikroscheren
 Micro-Tijeras
 Micro-Ciseaux
 Micro-Forbici



77-804-15
 Straight
 15 cm (6")



77-804-18
 Straight
 18 cm (7")



77-804-21
 Straight
 21 cm (8 1/4")



77-804-23
 Straight
 23 cm (9")

Micro Scissor
 Blade Length 10 mm, Flat Handle



77-804-15 T
 Straight
 15 cm (6")



77-804-18 T
 Straight
 18 cm (7")



77-804-21 T
 Straight
 21 cm (8 1/4")



Micro Scissor
 Blade Length 10 mm, Flat Handle

Micro Scissors
Mikroscheren
Micro-Tijeras
Micro-Ciseaux
Micro-Forbici



77-805-15
Straight
15 cm (6")



77-805-18
Straight
18 cm (7")



77-805-21
Straight
21 cm (8 1/4")



77-805-23
Straight
23 cm (9")

Micro Scissor
Blade Length 10 mm, Flat Handle



77-805-15 T
Straight
15 cm (6")



77-805-18 T
Straight
18 cm (7")



77-805-21 L
Straight
21 cm (8 1/4")



TITANIUM

Micro Scissor
Blade Length 10 mm, Flat Handle

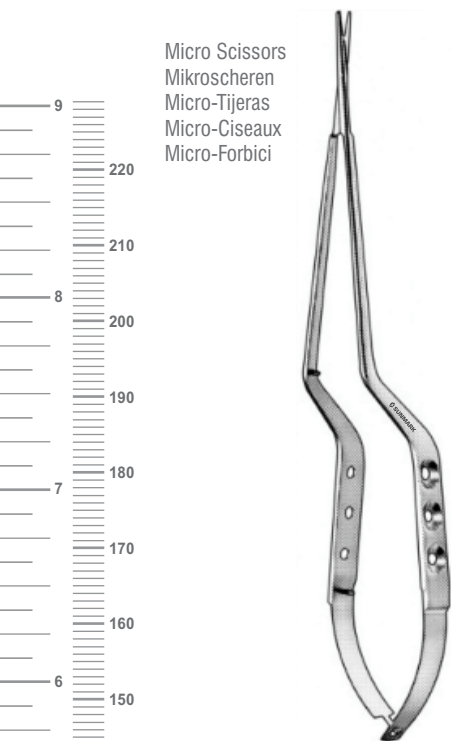

Micro Scissors
Mikroscheren
Micro-Tijeras
Micro-Ciseaux
Micro-Forbici

77-806-23
Straight, Blunt/Blunt

77-807-23
Curved, Upwards

Yasargil Micro Scissor
Bayonet Shaped
Overall Length 23 cm (9")

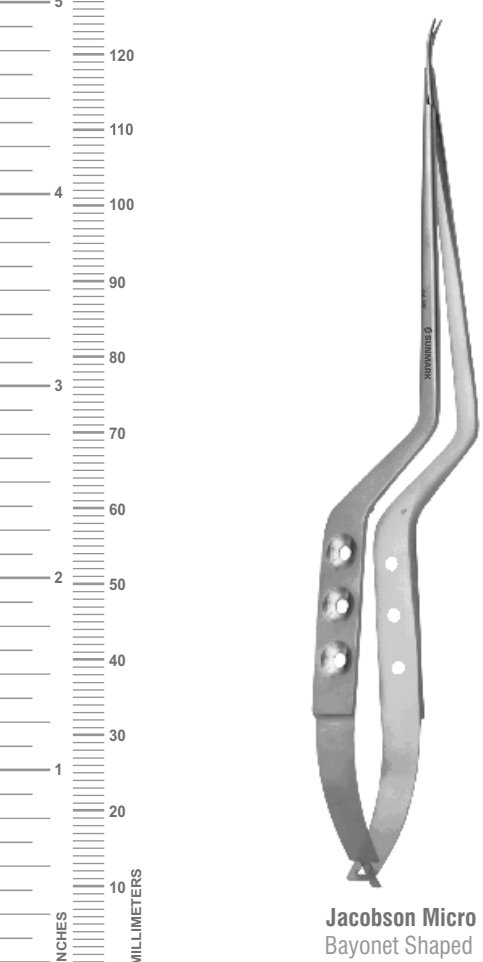

Jacobson Micro Scissor
Bayonet Shaped



77-808-23
Jacobson
Straight
23 cm (9")

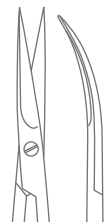

77-809-23
Potts
Curved
23 cm (9")

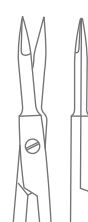

77-810-23
Straight
23 cm (9")



77-811-23
Curved
23 cm (9")

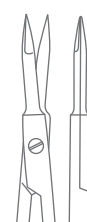

77-814-19
Straight
18.5 cm (7 1/4")

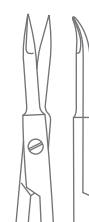

77-815-19
Curved
18.5 cm (7 1/4")

Micro Scissors
Mikroscheren
Micro-Tijeras
Micro-Ciseaux
Micro-Forbici

77

SCISSORS



Micro Scissor
Bayonet Shaped



77-816-19
Straight
19 cm (7 1/2")



77-816-21
Straight
21.5 cm (8 1/2")

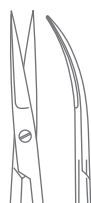

77-817-19
Curved
Downwards
19 cm (7 1/4")

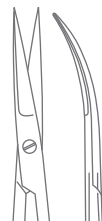

77-817-21
Curved
Downwards
21.5 cm (8 1/2")

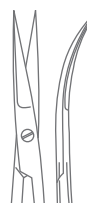

77-819-19
Curved
Upwards
19 cm (7 1/4")



77-819-21
Curved
Upwards
21.5 cm (8 1/2")





Micro Scissors
Mikroscheren
Micro-Tijeras
Micro-Ciseaux
Micro-Forbici



Jaboma Micro Scissor
Angled, One Blade Probe Tip
Overall Length 18 cm (7")

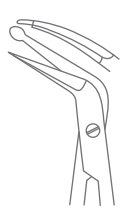

77-825-18
Right, 12 mm

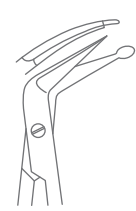

77-827-18
Left, 12 mm



77-829-18
Systrunk Nail Splitting Scissor
12 mm
Overall Length 18 cm (7")

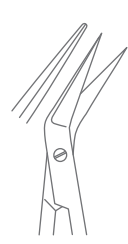

77-837-21
Micro Scissor
Curved Upwards, Bayonet Shape
Overall Length 21 cm (8 1/4")

Operating Scissors
Chirurgische Scheren
Tijeras quirúrgicas
Ciseaux chirurgicaux
Forbici per chirurgia

77

SCISSORS



ULTRA *Cut*™

ULTRA *Cut*™



Operating Scissors
Chirurgische Scheren
Tijeras quirúrgicas
Ciseaux chirurgicaux
Forbici per chirurgia

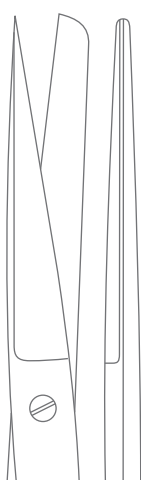

77-852-14
Straight

UltraCut™ TC Operating Scissor
Sharp/Blunt
Overall Length 14.5 cm (5 3/4")

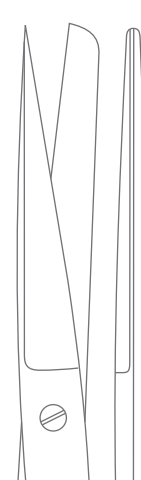

77-852-14 SC
Straight

XTSCut™ TC Operating Scissor
Sharp/Blunt
Overall Length 14.5 cm (5 3/4")



Operating Scissors
Chirurgische Scheren
Tijeras quirúrgicas
Ciseaux chirurgicaux
Forbici per chirurgia

77

SCISSORS



77-853-14
Curved

UltraCut™ TC Operating Scissor
Sharp/Blunt
14.5 cm (5 ¾")

ULTRA.Cut™



77-853-14 SC
Curved

XTSCut™ TC Operating Scissor
Sharp/Blunt
14.5 cm (5 ¾")

XTS.Cut™

Operating Scissors
Chirurgische Scheren
Tijeras quirúrgicas
Ciseaux chirurgicaux
Forbici per chirurgia

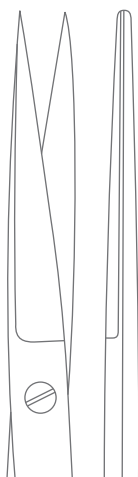

77-854-14
Straight



77-855-14
Curved

UltraCut™ TC Operating Scissor
Sharp/Sharp
Overall Length 14.5 cm (5 ¾")

ULTRA.Cut™

Dissecting Scissors
Präparierscheren
Tijeras de disección
Ciseaux à dissection
Forbici per dissezione



77-860-14
14.5 cm (5 ¾")

77-860-17
17 cm (6 ¾")

77-860-23
23 cm (9")

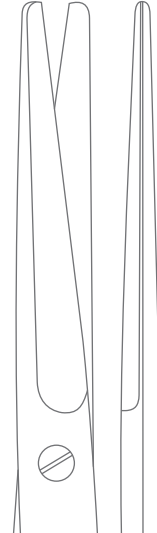

ULTRA *Cut*™

UltraCut™ TC Mayo Dissecting Scissor
Straight



77-860-14 SC
14.5 cm (5 ¾")

77-860-17 SC
17 cm (6 ¾")

77-860-23 SC
23 cm (9")

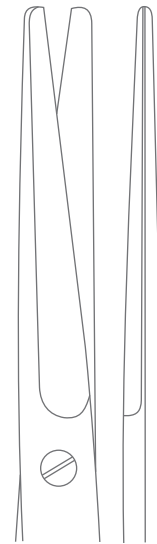

XTS *cut*™

XTSCut™ TC Mayo Dissecting Scissor
Straight

Dissecting Scissors
Präparierscheren
Tijeras de disección
Ciseaux à dissection
Forbici per dissezione



77-861-14
14.5 cm (5 3/4")

77-861-17
17 cm (6 3/4")

77-861-23
23 cm (9")

ULTRA *Cut*™

UltraCut™ TC Mayo Dissecting Scissor
Curved



77-861-14 SC
14.5 cm (5 3/4")

77-861-17 SC
17 cm (6 3/4")

77-861-23 SC
23 cm (9")

XTS *cut*™

XTSCut™ TC Mayo Dissecting Scissor
Curved

Dissecting Scissors
Präparierscheren
Tijeras de disección
Ciseaux à dissection
Forbici per dissezione

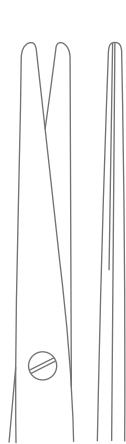

77-890-15
15 cm (6")

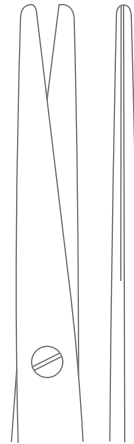

77-890-17
17 cm (6 3/4")

ULTRA Cut™

UltraCut™ TC Mayo-Stillle Dissecting Scissor
Straight



77-890-15 SC
15 cm (6")

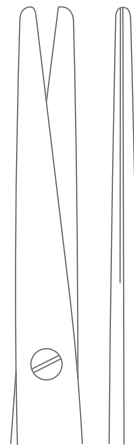

77-890-17 SC
17 cm (6 3/4")

XTS Cut™

XTSCut™ TC Mayo-Stillle Dissecting Scissor
Straight

Dissecting Scissors
Präparierscheren
Tijeras de disección
Ciseaux à dissection
Forbici per dissezione

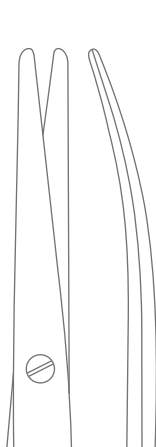

77-891-15
15 cm (6")



77-891-17
17 cm (6 3/4")

ULTRA Cut™

UltraCut™ TC Mayo-Style Dissecting Scissor
Curved

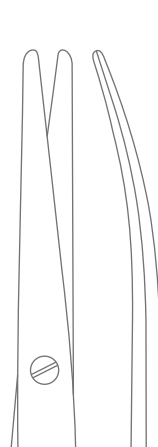

77-891-15 SC
15 cm (6")



77-891-17 SC
17 cm (6 3/4")

XTS Cut™

XTSCut™ TC Mayo-Style Dissecting Scissor
Curved

Dissecting Scissors
Präparierscheren
Tijeras de disección
Ciseaux à dissection
Forbici per dissezione



77-891-15
15 cm (6")



77-891-17
17 cm (6 3/4")

ULTRA Cut™

UltraCut™ TC Mayo-Style Dissecting Scissor
Curved



77-891-15 SC
15 cm (6")



77-891-17 SC
17 cm (6 3/4")

XTS Cut™

XTSCut™ TC Mayo-Style Dissecting Scissor
Curved

Dissecting Scissors
Präparierscheren
Tijeras de disección
Ciseaux à dissection
Forbici per dissezione



UltraCut™ TC Metzenbaum Dissecting Scissor

Overall Length 11.5 cm (4 ½")



UltraCut™ TC Metzenbaum Dissecting Scissor

Overall Length 14.5 cm (5 ¾")

Dissecting Scissors
Präparierscheren
Tijeras de disección
Ciseaux à dissection
Forbici per dissezione



77-902-14 SC
Straight

77-903-14 SC
Curved

XTSCut™TC Metzenbaum Dissecting Scissor
Overall Length 14.5 cm (5 ¾")

XTS·cut

Dissecting Scissors
Präparierscheren
Tijeras de disección
Ciseaux à dissection
Forbici per dissezione



UltraCut™ Metzenbaum-Nelson Dissecting Scissor
Straight, Blunt/Blunt

ULTRA *Cut*™

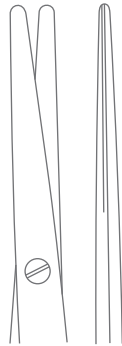

77-904-18
18 cm (7")



77-904-20
20.5 cm (8")

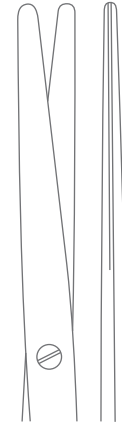

77-904-23
23 cm (9")

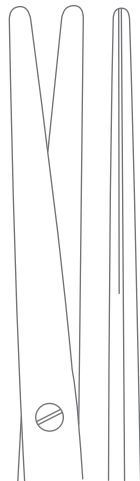

77-904-25
26 cm (10 1/4")

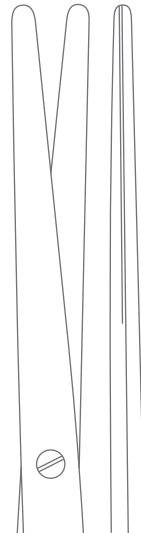

77-904-28
28.5 cm (11 1/4")

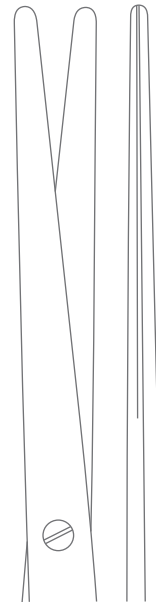

77-904-30
31 cm (12 1/4")

Dissecting Scissors
Präparierscheren
Tijeras de disección
Ciseaux à dissection
Forbici per dissezione



77-904-18
18 cm (7")



77-904-20
20.5 cm (8")

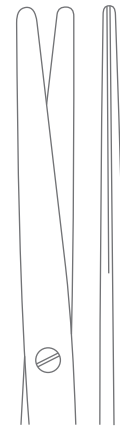

77-904-23
23 cm (9")

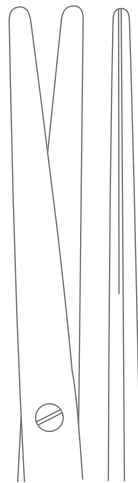

77-904-25
26 cm (10 1/4")

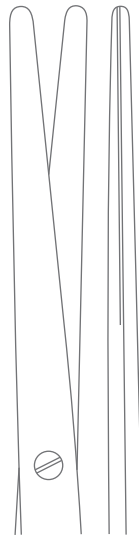

77-904-28
28.5 cm (11 1/4")

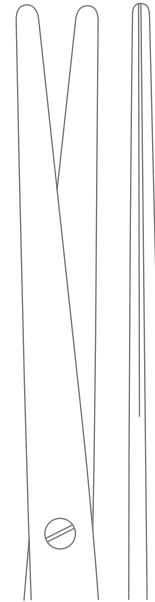

77-904-30
31 cm (12 1/4")

UltraCut™ Metzenbaum-Nelson Dissecting Scissor
Straight, Blunt/Blunt

ULTRA *Cut*™

Dissecting Scissors
 Präparierscheren
 Tijeras de disección
 Ciseaux à dissection
 Forbici per dissezione

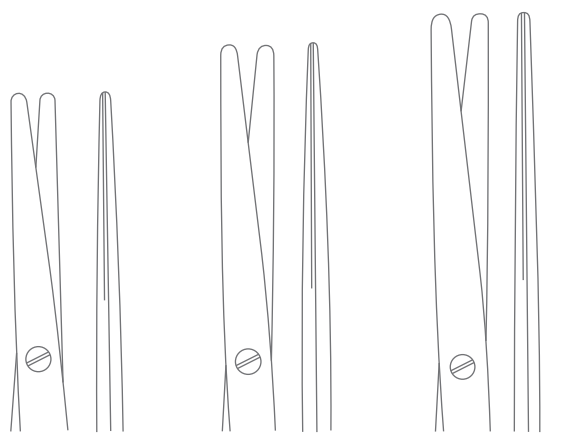

77-904-18 SC
18 cm (7")

77-904-20 SC
20.5 cm (8")

77-904-23 SC
23 cm (9")

XTSCut™

XTSCut™ Metzenbaum-Nelson Dissecting Scissor
Straight, Blunt/Blunt

Dissecting Scissors
Präparierscheren
Tijeras de disección
Ciseaux à dissection
Forbici per dissezione



UltraCut™ Metzenbaum-Nelson Dissecting Scissor
Curved, Blunt/Blunt

ULTRA.Cut™



77-905-18
18 cm (7")



77-905-20
20.5 cm (8")

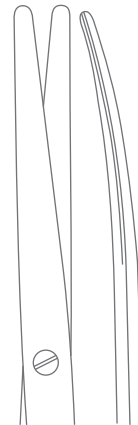

77-905-23
23 cm (9")

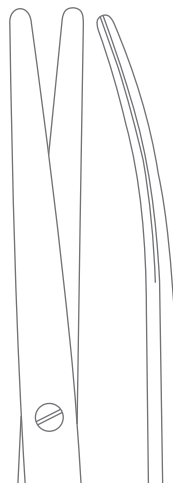

77-905-25
26 cm (10 1/4")

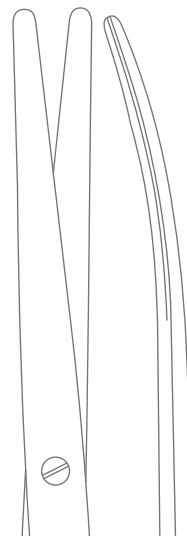

77-905-28
28.5 cm (11 1/4")

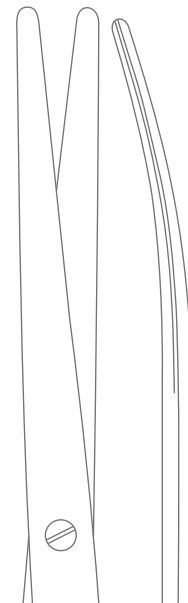

77-905-30
31 cm (12 1/4")

Dissecting Scissors
Präparierscheren
Tijeras de disección
Ciseaux à dissection
Forbici per dissezione



77-905-18 SC
18 cm (7")



77-905-20 SC
20.5 cm (8")



77-905-23 SC
23 cm (9")

XTS-Cut™

XTS-Cut™ Metzenbaum-Nelson Dissecting Scissor
Curved, Blunt/Blunt

Dissecting Scissors
 Präparierscheren
 Tijeras de disección
 Ciseaux à dissection
 Forbici per dissezione

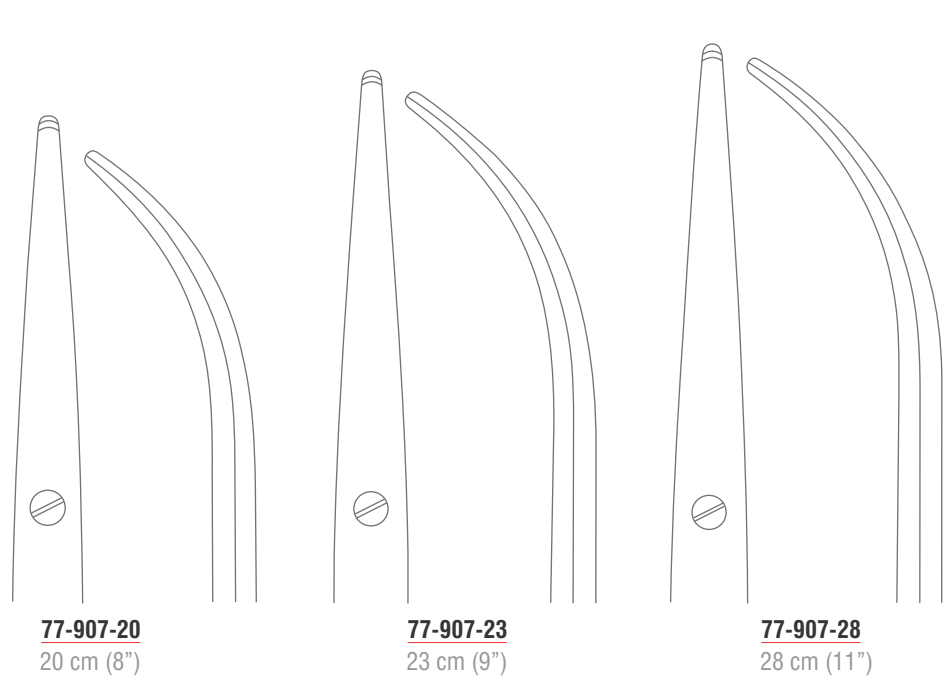

ULTRA *Cut*™

UltraCut™ TC Metzenbaum -Thorek Dissecting Scissor
 Curved

Dissecting Scissors
 Präparierscheren
 Tijeras de disección
 Ciseaux à dissection
 Forbici per dissezione

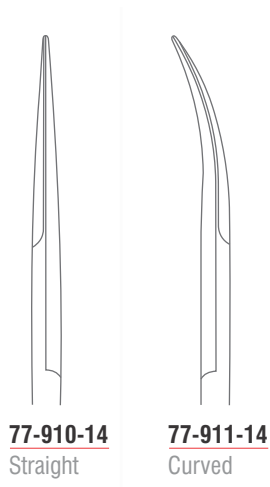
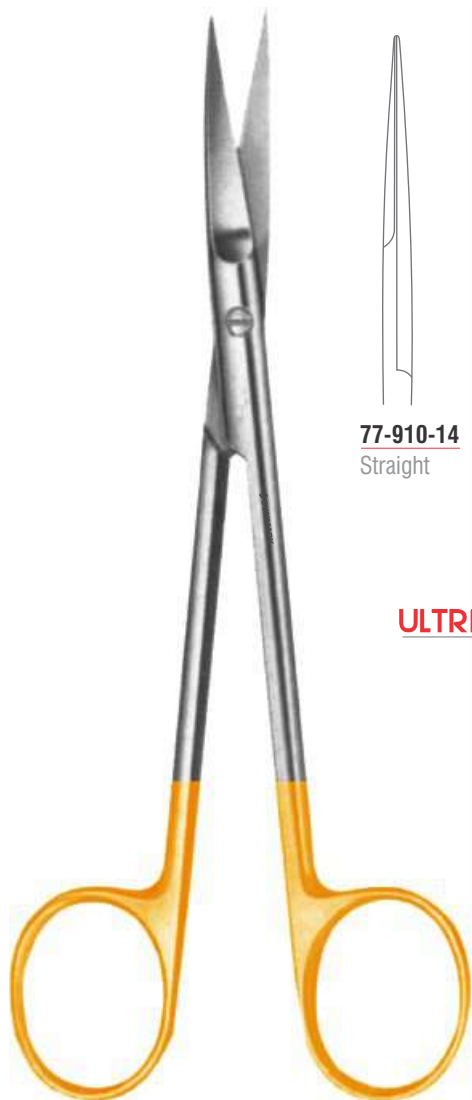

77-910-14
Straight

77-911-14
Curved

ULTRA *Cut*™

UltraCut™ TC Joseph Dissecting Scissor
 Overall Length 14.5 cm (5 3/4")

Dissecting Scissors
Präparierscheren
Tijeras de disección
Ciseaux à dissection
Forbici per dissezione

SCISSORS

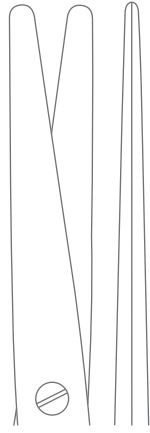

77-914-16
Straight
16 cm (6 ¼")

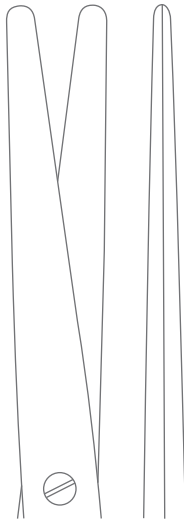

77-914-21
Straight
21 cm (8 ¼")



77-915-16
Curved
16 cm (6 ¼")



77-915-21
Curved
21 cm (8 ¼")

ULTRA.Cut™

UltraCut™ TC Lexer Dissecting Scissor

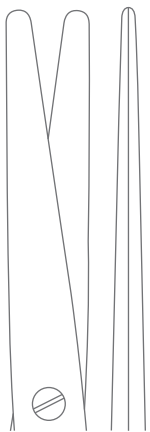
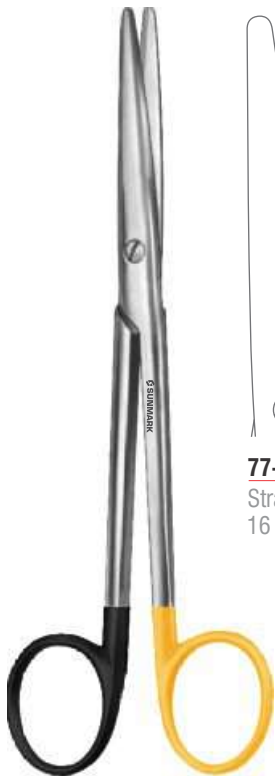

77-914-16 SC
Straight
16 cm (6 ¼")

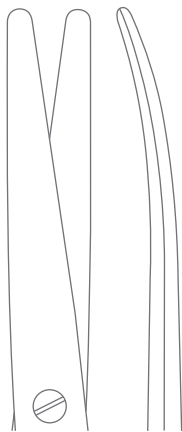

77-915-16 SC
Curved
16 cm (6 ¼")

XTS.Cut™

XTSCut™ TC Lexer Dissecting Scissor

Dissecting Scissors
Präparierscheren
Tijeras de disección
Ciseaux à dissection
Forbici per dissezione

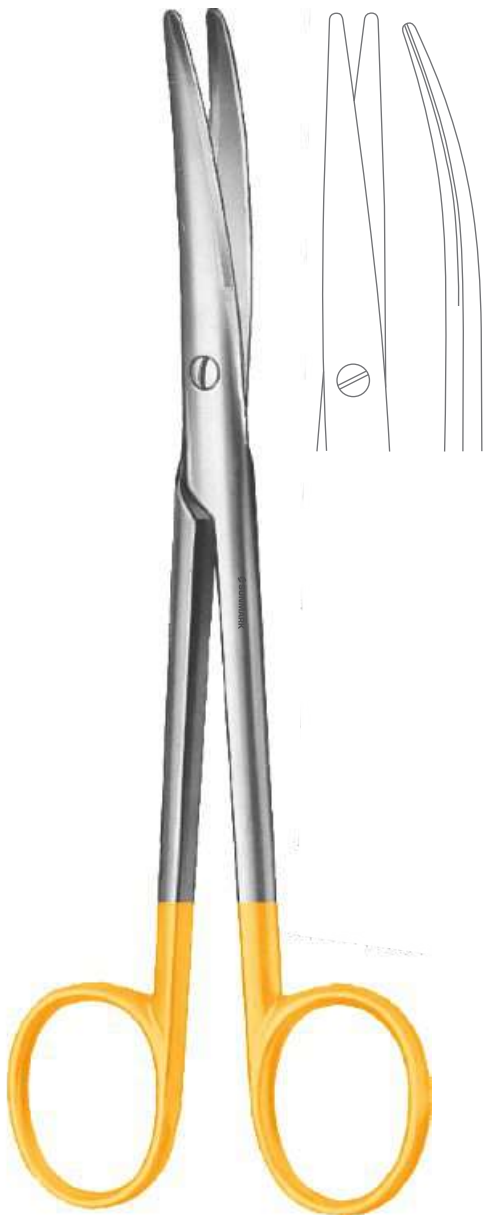

77-917-16
UltraCut™ TC Mayo-Lexer Dissecting Scissor
Curved
Overall Length 16 cm (6 1/4")

ULTRA.Cut™

Dissecting Scissors
Präparierscheren
Tijeras de disección
Ciseaux à dissection
Forbici per dissezione

SCISSORS



77-920-14
Straight

77-921-14
Curved

ULTRACut™

UltraCut™ TC Metzenbaum-Fine Delicate Dissecting Scissor
Slender Pattern
Overall Length 14.5 cm (5 ¾")



77-920-14 SC
Straight

77-921-14 SC
Curved

XTScut™

XTSCut™ TC Metzenbaum-Fine Delicate Dissecting Scissor
Slender Pattern
Overall Length 14.5 cm (5 ¾")

Dissecting Scissors
 Präparierscheren
 Tijeras de disección
 Ciseaux à dissection
 Forbici per dissezione

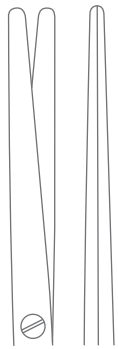

77-922-18
 Straight
 18 cm (7")

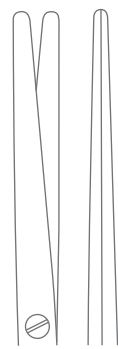

77-922-20
 Straight
 20.5 cm (8")

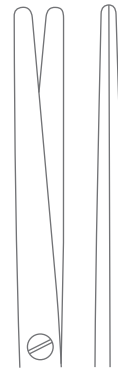

77-922-23
 Straight
 23 cm (9")

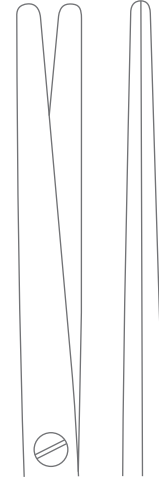

77-922-25
 Straight
 25 cm (9 3/4")

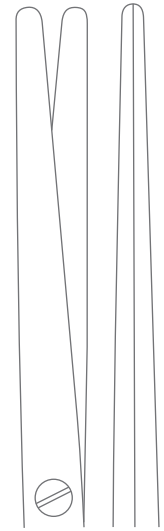

77-922-28
 Straight
 28 cm (11")

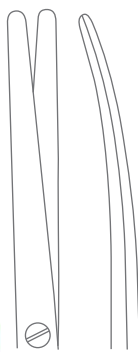

77-923-18
 Curved
 18 cm (7")



77-923-20
 Curved
 20.5 cm (8")

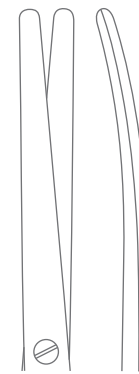

77-923-23
 Curved
 23 cm (9")

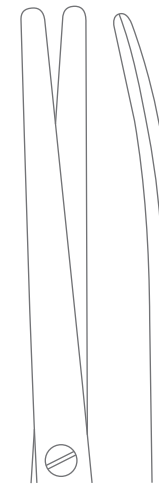

77-923-25
 Curved
 25 cm (9 3/4")

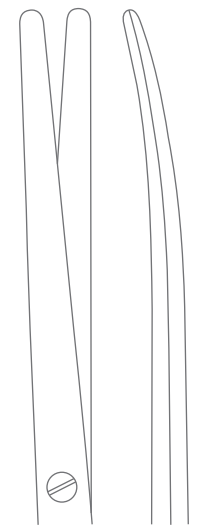

77-923-28
 Curved
 28.5 cm (11 1/4")

UltraCut™ TC Metzenbaum-Fine Delicate Dissecting Scissor
 Slender Pattern

ULTRA *Cut*™

Dissecting Scissors
Präparierscheren
Tijeras de disección
Ciseaux à dissection
Forbici per dissezione



XTSCut™ TC Metzenbaum-Fine Delicate Dissecting Scissor
Slender Pattern

XTS·cut

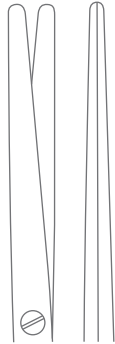

77-922-18 SC
Straight
18 cm (7")

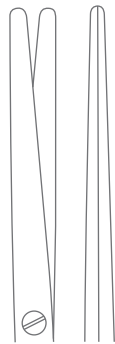

77-922-20 SC
Straight
20.5 cm (8")

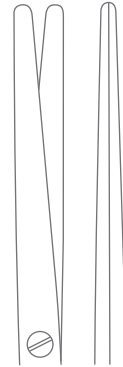

77-922-23 SC
Straight
23 cm (9")

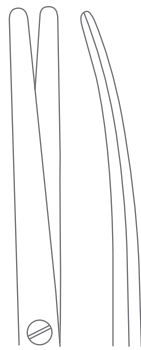

77-923-18 SC
Curved
18 cm (7")

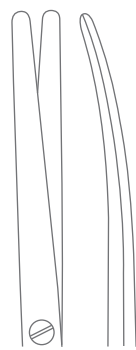

77-923-20 SC
Curved
20.5 cm (8")

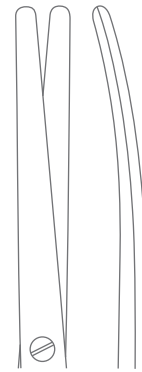

77-923-23 SC
Curved
23 cm (9")

Dissecting Scissors
Präparierscheren
Tijeras de disección
Ciseaux à dissection
Forbici per dissezione



77-926-14
Straight

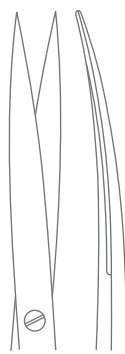

77-927-14
Curved

UltraCut™ TC Metzenbaum-Fine Delicate Dissecting Scissor
Overall Length 14.5 cm (5 3/4")

ULTRA *Cut*™

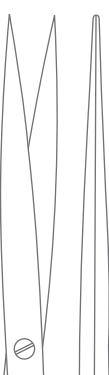

77-928-18
Straight

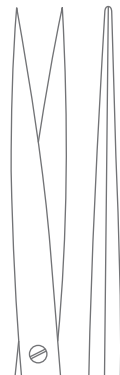

77-928-20
Straight

UltraCut™ TC Metzenbaum-Fine Delicate Dissecting Scissor
Straight

ULTRA *Cut*™

Dissecting Scissors
 Präparierscheren
 Tijeras de disección
 Ciseaux à dissection
 Forbici per dissezione

77

SCISSORS

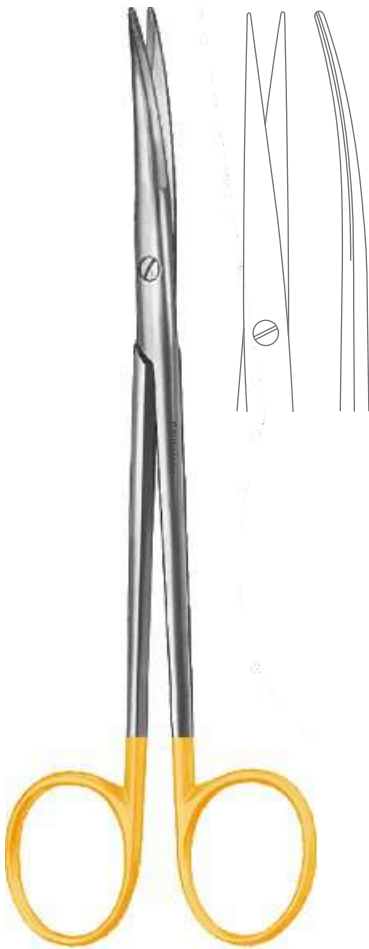

77-931-14

UltraCut™ TC Metzenbaum-Lahey Dissecting Scissor

Curved

Overall Length 14.5 cm (5 ¾")

ULTRA *Cut*™



77-933-17

UltraCut™ TC Toennis-Adson Dissecting Scissor

Curved, Slender Pattern

Overall Length 17.5 cm (7")

ULTRA *Cut*™

Dissecting Scissors
 Präparierscheren
 Tijeras de disección
 Ciseaux à dissection
 Forbici per dissezione



77-935-20
 Curved
 20.5 cm 8"

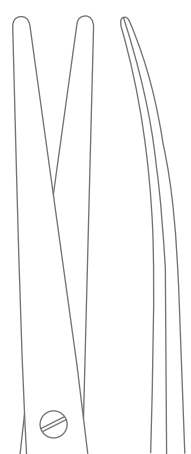

77-935-23
 Curved
 23.5 cm 9"

ULTRA *Cut*™

UltraCut™ TC Metzenbaum-Lahey Dissecting Scissor
 Slender Pattern

Dissecting Scissors
Präparierscheren
Tijeras de disección
Ciseaux à dissection
Forbici per dissezione

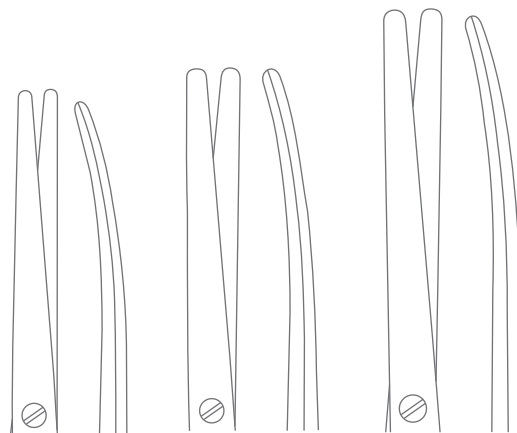
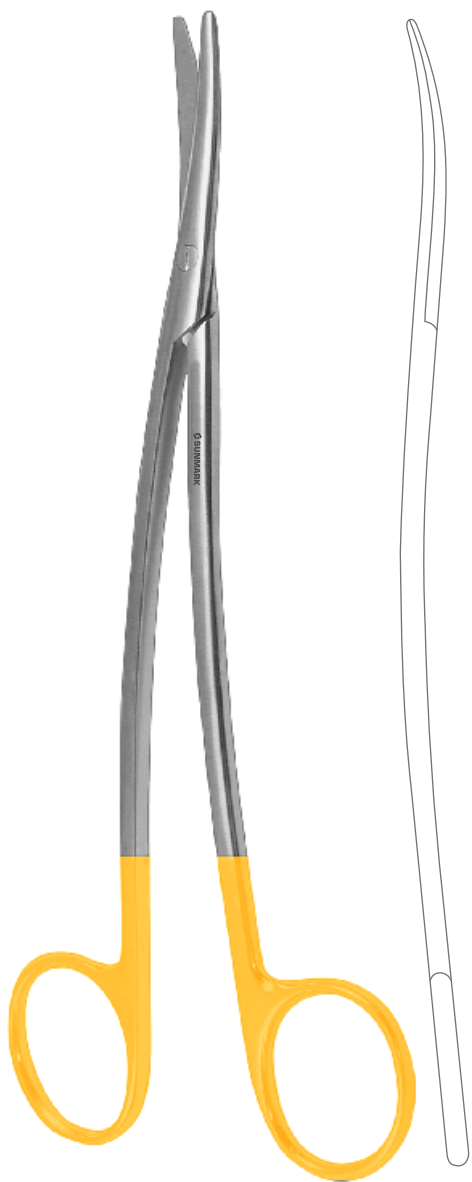

77-937-18
18 cm (7")

77-937-20
20.5 cm (8")

77-937-23
23 cm (9")

ULTRA *Cut*™

UltraCut™ TC Metzenbaum-Fine Dissecting Scissor
Curved, S Shaped, Slender Pattern

Nasal Scissors
Nasenscheren
Tijeras nasals
Ciseaux nasaux
Forbici nasali



77-939-15
UltraCut™ TC Fomon Nasal Scissor
Overall Length 14.5 cm (5 ¾")

ULTRA.Cut™



77-941-16
UltraCut™ TC Cottle Nasal Scissor
Overall Length 16 cm (6 ¼")

ULTRA.Cut™

Face-lift Scissors
Face-lift-Scheren
Tijeras para Face-Lift
Ciseaux pour Face-lift
Forbici per Face-lift

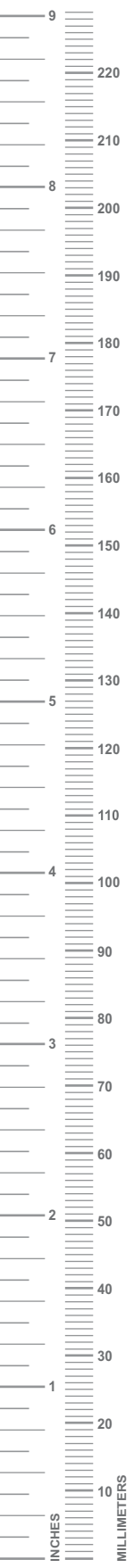

77-944-20
20 cm (8")

UltraCut™ TC Gorney Face-Lift Scissor
Straight, One Toothed Cutting Edge

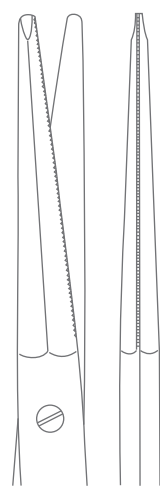

77-944-23
23 cm (9")



77-947-17
UltraCut™ TC Rees Face-Lift Scissor
Curved, One Toothed Cutting Edge
Overall Length 17 cm (6 3/4")



Face-lift Scissors
Face-lift-Scheren
Tijeras para Face-Lift
Ciseaux pour Face-lift
Forbici per Face-lift



77-949-14
UltraCut™ TC Gregory Face-Lift Scissor
One Toothed Cutting Edge
Overall Length 14 cm (5 ½")

ULTRA *Cut™*



77-951-15
15 cm (6")

77-951-18
18 cm (7")

UltraCut™ TC Kaye Face-Lift Scissor
One Toothed Cutting Edge

ULTRA *Cut™*

Face-lift Scissors
 Face-lift-Scheren
 Tijeras para Face-Lift
 Ciseaux pour Face-lift
 Forbici per Face-lift



77-953-18
UltraCut™ TC Stella-S Face-Lift Scissor
 S Shaped, One Toothed Cutting Edge
 Overall Length 18 cm (7")

ULTRA *Cut*™



77-959-18
UltraCut™ TC Stella-S Face-Lift Scissor
 One Toothed Cutting Edge
 Overall Length 18 cm (7")

ULTRA *Cut*™

Face-lift Scissors
Face-lift-Scheren
Tijeras para Face-Lift
Ciseaux pour Face-lift
Forbici per Face-lift



77-961-18
UltraCut™ TC Freeman-Kaye Face-Lift Scissor
One Toothed Cutting Edge
Overall Length 18 cm (7")

ULTRA *Cut*™

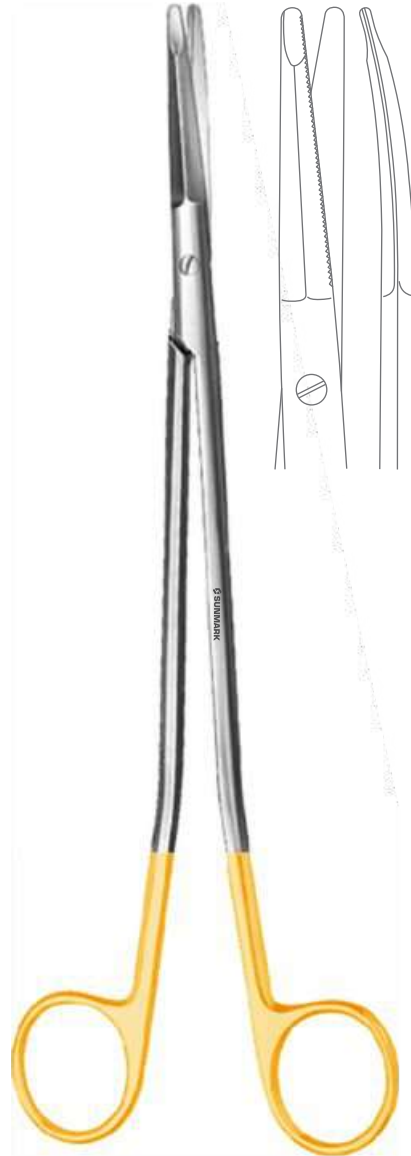

77-963-23
UltraCut™ TC Freeman-Kaye Face-Lift Scissor
One Toothed Cutting Edge
Overall Length 23 cm (9")

ULTRA *Cut*™

Gynecological Scissors
Gynäkologische Scheren
Tijeras para ginecología
Ciseaux à gynécologie
Forbici per ginecologia



77-965-23
23 cm (9")



77-965-35
35 cm (14")



77-968-23
Systrunk Nail Splitting Scissor
Straight
Overall Length 23 cm (9")

ULTRA.Cut™

ULTRA.Cut™

Hysterectomy Scissors
Hysterektomiescheren
Tijeras para histerectomia
Ciseaux à hystérectomie
Forbici per isterectomia



77-969-23
UltraCut™ TC Sims Uterine Scissor
Curved
Overall Length 23 cm (9")

ULTRA *Cut*™



UltraCut™ TC Parametrium Hysterectomy Scissor

ULTRA *Cut*™

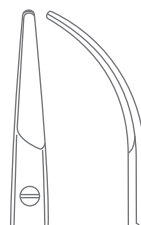

77-971-01
Strongly Curved



77-971-02
Curved

77-971-03
Slightly Curved

77-971-04
Strongly Curved

77-971-05
Medium Curved

77-971-06
Slightly Curved

77-971-07
Medium Curved

77-971-08
Slightly Curved

Ophthalmology Instruments
 Ophthalmologie Instrumente
 Oftalmología Instrumentos
 Ophthalmologie Instrumente
 Oftalmologia Strumenti



UltraCut™ TC Stevens Tenotomy Scissor

ULTRA *Cut*™



77-972-10
 Straight
 Blunt/Blunt
 10.5 cm (4 1/4")

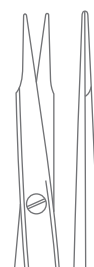

77-972-11
 Straight
 Blunt/Blunt
 11.5 cm (4 1/2")



77-973-10
 Curved
 Blunt/Blunt
 10.5 cm (4 1/4")



77-973-11
 Curved
 Blunt/Blunt
 11.5 cm (4 1/2")



77-974-10
 Straight
 Sharp/Sharp
 10.5 cm (4 1/4")



77-974-11
 Straight
 Sharp/Sharp
 11.5 cm (4 1/2")



77-975-10
 Curved
 Sharp/Sharp
 10.5 cm (4 1/4")



77-975-11
 Curved
 Sharp/Sharp
 11.5 cm (4 1/2")

Gum Scissors
Zahnfleischscheren
Tijeras para encías
Ciseaux à gencives
Forbici per gengiva



77-976-13
Straight



77-977-13
Curved

UltraCut™ Goldman-Fox Gum Scissor
One Toothed Cutting Edge
Overall Length 13 cm (5")

ULTRA *Cut*™

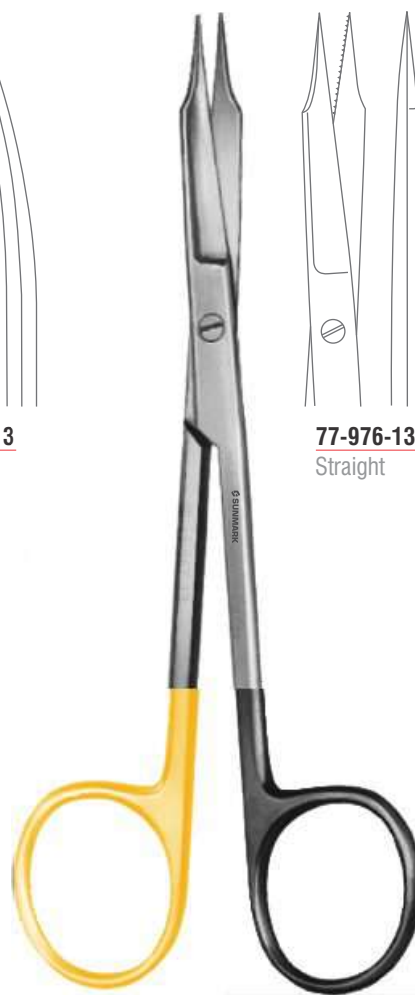

77-976-13
Straight

77-977-13
Curved

XTSCut™ TC Goldman-Fox Gum Scissor
One Toothed Cutting Edge
Overall Length 13 cm (5")

XTS *cut*™

Iris Scissors
Irisscheren
Tijeras para iridectomía
Ciseaux à iridectomie
Forbici per iridectomia



UltraCut™ TC Iris Scissor
Overall Length 11.5 cm (4 1/2")



77-978-11
Straight



77-979-11
Curved

ULTRA *Cut*™



XTSCut™ TC Iris Scissor
Overall Length 11.5 cm (4 1/2")



77-978-11 SC
Straight



77-979-11 SC
Curved

XTS *Cut*

Vascular Scissors
Gefäßscheren
Tijeras vasculares
Ciseaux vasculaires
Forbici vascolari



UltraCut™ TC DeBakey Vascular Scissor

ULTRA.Cut™

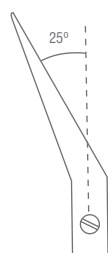

77-981-25
Angled 25°
19 cm (7 1/2")



77-983-25
Angled 25°
23 cm (9")

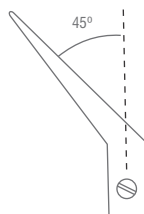

77-981-45
Angled 45°
18.5 cm (7 1/4")

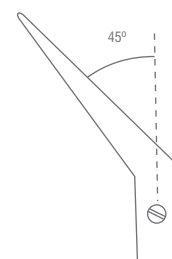

77-983-45
Angled 45°
23 cm (9")

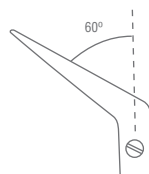

77-981-60
Angled 60°
18 cm (7")

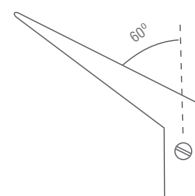

77-983-60
Angled 60°
22 cm (8 3/4")

Iris Scissors, Dissecting Scissors
 Irisscheren, Präparierscheren
 Tijeras para iridectomía, Tijeras de disección
 Ciseaux à iridectomie, Ciseaux à dissection
 Forbici per iridectomia, Forbici per dissezione

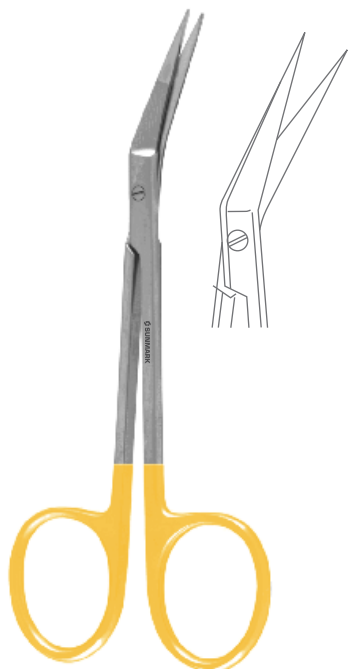

77-985-11
UltraCut™ TC Iris Scissor
 Angled
 Overall Length 11 cm (4 1/2")

ULTRA *Cut*™



77-987-12
 12.5 cm (5")

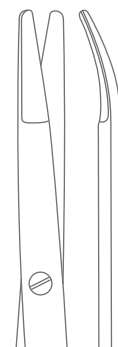

77-987-15
 15 cm (6")

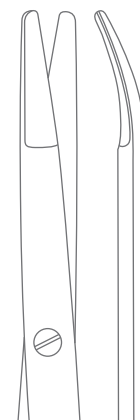

77-987-18
 18 cm (7")

UltraCut™ TC Ragnell (Kilner) Dissecting Scissor
 Curved

ULTRA *Cut*™



77-988-16
 Straight



77-989-16
 Curved

ULTRA *Cut*™

UltraCut™ TC Kelly Dissecting Scissor
 Overall Length 16 cm (6 1/4")

Wire Cutting Scissors
Drahtscheren
Tijeras para cortar hilos de acero
Ciseaux coupe-fil
Forbici per tagliare fili metallic

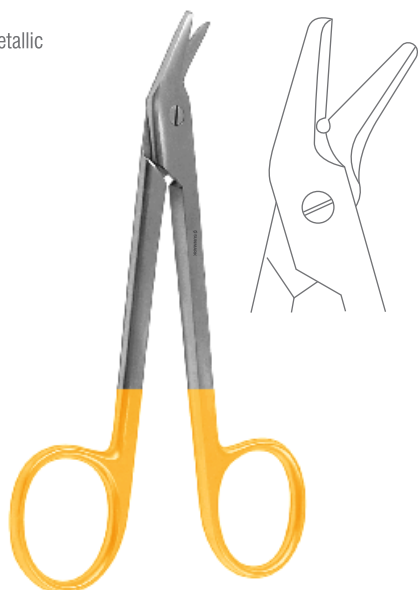

77-991-12

UltraCut™ TC Universal Wire Cutting Scissor

Angled One Toothed Cutting Edge

Overall Length 12.5 cm (5")

ULTRA *Cut*™



77-992-16

UltraCut™ TC Smith Wire Cutting Scissor

Angled One Toothed Cutting Edge

Overall Length 16 cm (6 1/4")

ULTRA *Cut*™



77-993-17

UltraCut™ TC Dean Tonsil Scissor

S Shaped, Angled Upwards

Overall Length 17.5 cm (7")

Wire Cutting Scissors
 Drahtscheren
 Tijeras para cortar hilos de acero
 Ciseaux coupe-fil
 Forbici per tagliare fili metallic

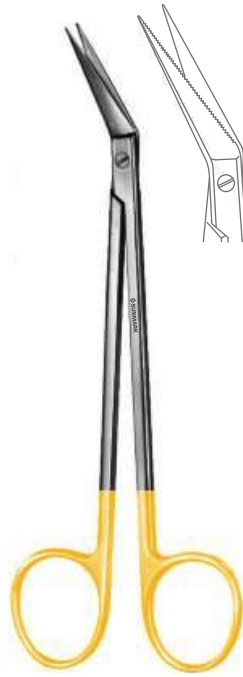

77-993-17

UltraCut™ TC Locklin Gum Scissor
 Angled, One Toothed Cutting Edge
 Overall Length 17.5 cm (7")

ULTRA.Cut™

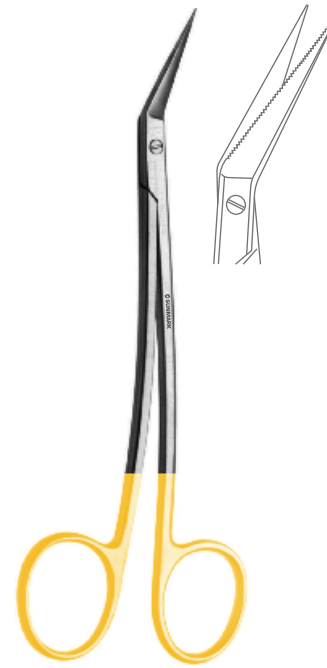

77-495-16

UltraCut™ TC Locklin Gum Scissor
 Angled, S Shaped One Toothed Cutting Edge
 Overall Length 16 cm (6 ¼")

ULTRA.Cut™



77-999-18

UltraCut™ TC Lister Bandage Scissor
 Overall Length 18 cm (7")

ULTRA.Cut™



Dissecting Forceps
 Anatomische Pinzetten
 Pinzas de disección
 Pinces à dissection
 Pinze per dissezione

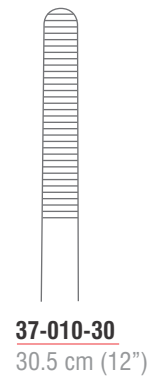
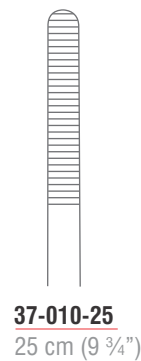
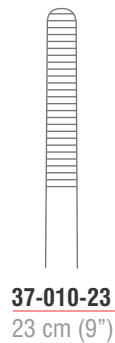
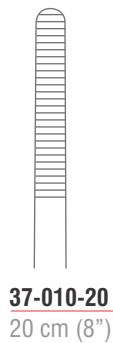
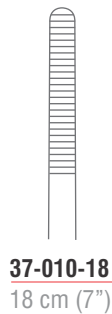
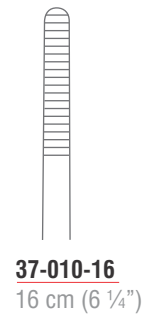
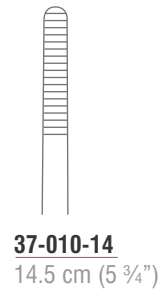
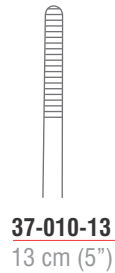

Standard Pattern Dressing Forcep
 Straight, Serrated

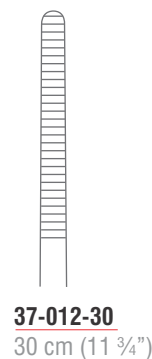
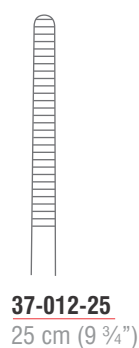
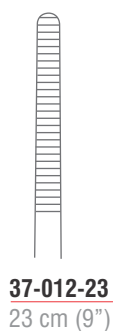
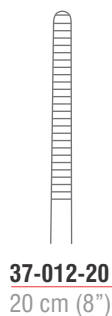
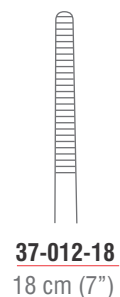
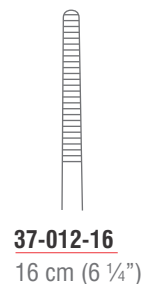
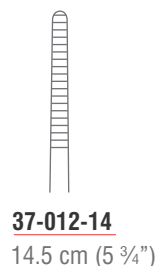

Slender Pattern Dressing Forcep
 Straight, Serrated

Dissecting Forceps
 Anatomische Pinzetten
 Pinzas de disección
 Pincès à dissection
 Pinze per dissezione



Slender Pattern Dressing Forcep
 Curved, Serrated



37-013-13
 13 cm (5")



37-013-14
 14 cm (5 1/2")

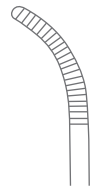

37-013-16
 16 cm (6 1/4")



Fine Pattern Dressing Forcep
 Straight, Serrated



37-016-13
 13 cm (5")



37-016-14
 14.5 cm (5 3/4")



37-016-16
 16 cm (6 1/4")



37-016-18
 18 cm (7")



37-016-20
 20 cm (8")

Dissecting Forceps
Anatomische Pinzetten
Pinzas de disección
Pincés à dissection
Pinze per dissezione



37-030-15
Stille Dressing Forcep
Round Tips
Overall Length 15 cm (6")



Stille Dressing Forcep
Square Tips

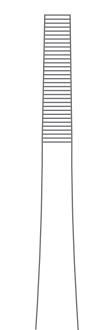

37-035-15
15 cm (6")



37-035-17
17 cm (6 ¾")



37-035-20
20 cm (8")

Dissecting Forceps
Anatomische Pinzetten
Pinzas de disección
Pinces à dissection
Pinze per dissezione



37-040-15
Treves Dressing Forcep
Overall Length 15 cm (6")



Adson Dressing Forcep



37-050-12
12 cm (4 3/4")

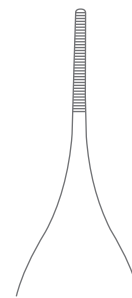

37-050-15
15 cm (6")

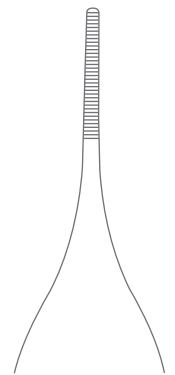

37-050-18
18 cm (7")

Dissecting Forceps
Anatomische Pinzetten
Pinzas de disección
Pincas à dissection
Pinze per dissezione



37-051-12
Adson Dressing Forcep
Curved
Overall Length 12 cm (4 3/4")



37-052-12
Mini Adson Dressing Forcep
Cross Serrated Tips
Overall Length 12 cm (4 3/4")

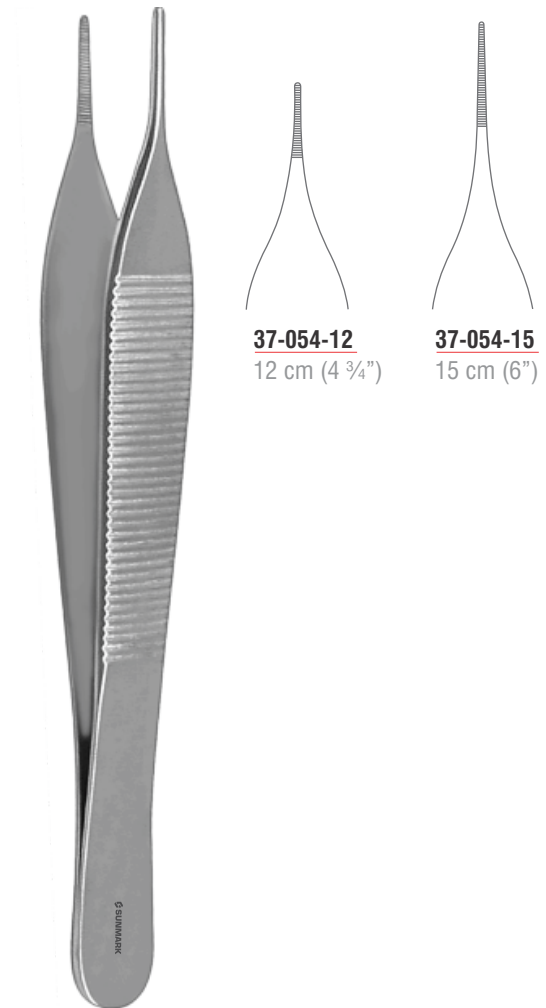

37-054-12
12 cm (4 3/4")

37-054-15
15 cm (6")

Micro Adson Dressing Forcep

Dissecting Forceps
Anatomische Pinzetten
Pinzas de disección
Pincès à dissection
Pinze per dissezione

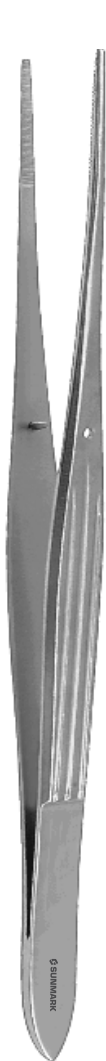

37-060-15
McIndoe Dressing Forcep
Overall Length 15 cm (6")



Semken Dressing Forcep

37-070-12
12.5 cm (5")

37-070-15
15 cm (6")



37-074-17
Taylor Dressing Forcep
Overall Length 17 cm (6 3/4")



37-076-17
Taylor Dressing Forcep
With Dissector End
Overall Length 17 cm (6 3/4")

Dissecting Forceps
Anatomische Pinzetten
Pinzas de disección
Pincès à dissection
Pinze per dissezione



37-078-17
Taylor Dressing Forcep
Bayonet Shaped, With Dissector End
Overall Length 18.5 cm (7 1/4")

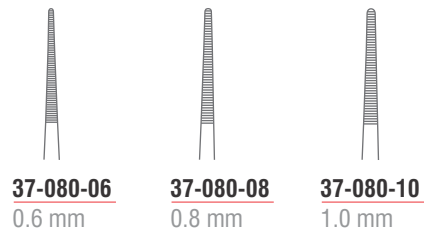

Turner Micro Dressing Forcep
Overall Length 15.5 cm (6")

Dissecting Forceps
Anatomische Pinzetten
Pinzas de disección
Pinces à dissection
Pinze per dissezione



Gerald Dressing Forcep
Straight



37-084-17
17.5 cm (7")



37-084-23
23 cm (9")



37-085-17
Gerald Dressing Forcep
Curved
Overall Length 17.5 cm (7")



Dissecting Forceps
Anatomische Pinzetten
Pinzas de disección
Pincers à dissection
Pinze per dissezione



Cushing Dressing Forcep
Straight



37-090-17
17.5 cm (7")



37-090-20
20 cm (8")



37-090-25
25 cm (9 3/4")



37-091-17
Cushing Dressing Forcep
Curved
Overall Length 17.5 cm (7")

Dissecting Forceps
Anatomische Pinzetten
Pinzas de disección
Pinces à dissection
Pinze per dissezione



Potts-Smith Dressing Forcep



37-094-18
18 cm (7")



37-094-21
21 cm (8 1/4")



37-094-25
24.5 (9 3/4")



37-094-30
30 cm (11 3/4")



37-096-15
Dressing Forcep
Overall Length 15.5 cm (6")

Dissecting Forceps
Anatomische Pinzetten
Pinzas de disección
Pincès à dissection
Pinze per dissezione



37-100-15
Gillies Dressing Forcep
Overall Length 15 cm (6")



37-102-20
Waugh Dressing Forcep
Cross Serrated
Overall Length 20 cm (8")

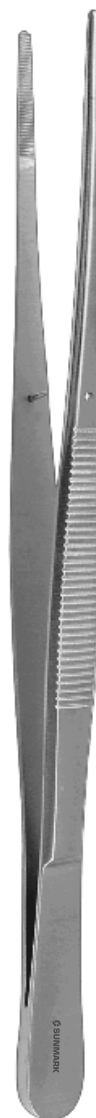

Brophy Dressing Forcep
Overall Length 20 cm (8")

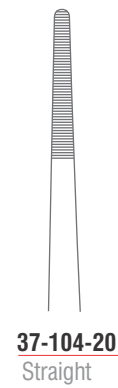

37-104-20
Straight

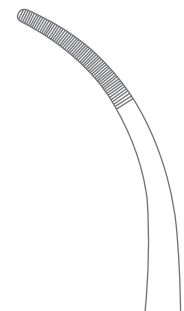

37-105-20
Curved

Dissecting Forceps
Anatomische Pinzetten
Pinzas de disección
Pincers à dissection
Pinze per dissezione

37

FORCEPS



37-108-20
Cooley Dressing Forcep
Cross Serrated Jaws
Overall Length 20 cm (8")



37-111-20
Dressing Forcep
Angled
Overall Length 20 cm (8")



37-112-13
Fricke Ligature Forcep
With Lock
Overall Length 13 cm (5")

Dissecting Forceps
Anatomische Pinzetten
Pinzas de disección
Pincès à dissection
Pinze per dissezione



37-114-14
Ochsner Dressing Forcep
Longitudinal Serrations
Overall Length 14.5 cm (5 3/4")



37-116-17
Bonney Dressing Forcep
Overall Length 17.5 cm (7")



37-118-18
Ramsey Dressing Forcep
Overall Length 18 cm (7")

Dissecting Forceps
 Anatomische Pinzetten
 Pinzas de disección
 Pinces à dissection
 Pinze per dissezione

FORCEPS



37-200-10
 10.5 cm (4 1/4")



37-200-11
 11.5 cm (4 1/2")



37-200-13
 13 cm (5")



37-200-14
 14.5 cm (5 3/4")



37-200-16
 16 cm (6 1/4")



37-200-18
 18 cm (7")



37-200-20
 20 cm (8")



37-200-23
 23 cm (9")



37-200-25
 25 cm (9 3/4")



37-200-30
 30.5 cm (12")

Slender Pattern Dissecting Forcep
 Straight, 1 x 2 Teeth

37-202-11
 12 cm (4 3/4")



37-202-13
 13 cm (5")



37-202-14
 14.5 cm (5 3/4")



37-202-16
 15.5 cm (6")



37-202-18
 18 cm (7")



37-202-20
 20 cm (8")



37-202-25
 24.5 cm (9 3/4")

Slender Pattern Dissecting Forcep
 Straight, 2 x 3 Teeth



Dissecting Forceps
Anatomische Pinzetten
Pinzas de disección
Pincès à dissection
Pinze per dissezione



37-204-14
14.5 cm (5 3/4")



37-204-16
16 cm (6 1/4")



37-206-14
14.5 cm (5 3/4")



37-206-16
16 cm (6 1/4")



Standard Pattern Dissecting Forcep
Straight, 3 x 4 Teeth



Standard Pattern Dissecting Forcep
Straight, 4 x 5 Teeth



Dissecting Forceps
Anatomische Pinzetten
Pinzas de disección
Pinces à dissection
Pinze per dissezione

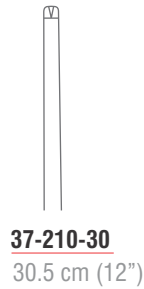
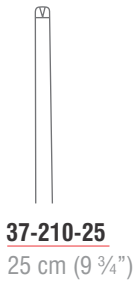
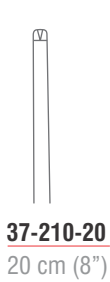
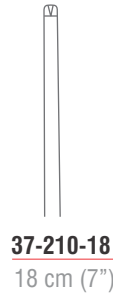
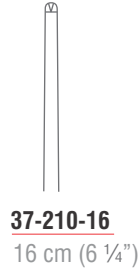
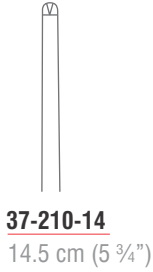
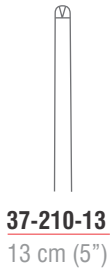

Slender Pattern Dissecting Forcep
Straight, 1 x 2 Teeth

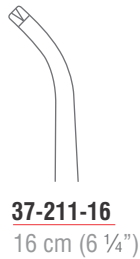

Slender Pattern Dissecting Forcep
Curved, 1 x 2 Teeth

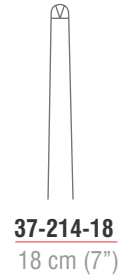
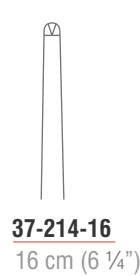
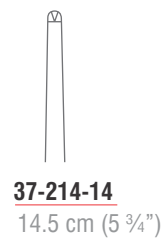
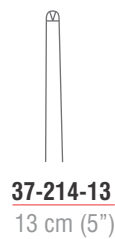

Fine Pattern Dissecting Forcep
Straight, 1 x 2 Teeth



Dissecting Forceps
Anatomische Pinzetten
Pinzas de disección
Pincès à dissection
Pinze per dissezione

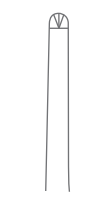

37-230-15
1 x 2 Teeth

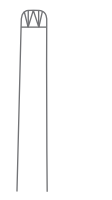

37-232-15
2 x 3 Teeth



37-234-15
Stone Dissecting Forcep
Overall Length 15 cm (5 3/4")



37-236-15
Lerche Dissecting Forcep
Overall Length 15 cm (6")



Dissecting Forceps
Anatomische Pinzetten
Pinzas de disección
Pincès à dissection
Pinze per dissezione

37

FORCEPS

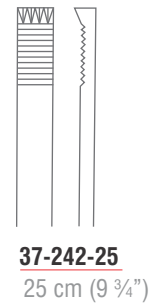
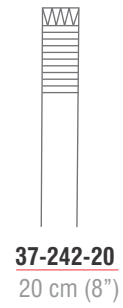
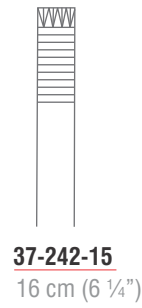
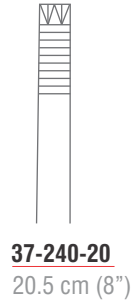
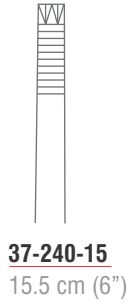

Adlerkreutz Dissecting Forcep
2 x 3 Teeth



Adlerkreutz Dissecting Forcep
4 x 5 Teeth



Dissecting Forceps
 Anatomische Pinzetten
 Pinzas de disección
 Pincas à dissection
 Pinze per dissezione



Adson Dissecting Forcep
 1 x 2 Teeth

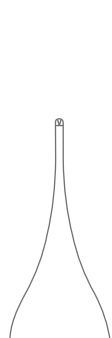

37-250-12
 12 cm (4 3/4")

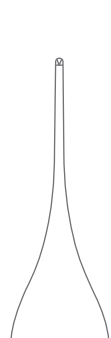

37-250-15
 15 cm (6")

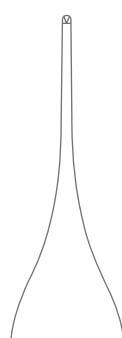

37-250-18
 18 cm (7")



Mini-Adson Dissecting Forcep
 1 x 2 Teeth, Cross Serrated
 Overall Length 15 cm (6")



37-252-12
 12 cm (4 3/4")



37-253-12
 12 cm (4 3/4")

Dissecting Forceps
Anatomische Pinzetten
Pinzas de disección
Pincès à dissection
Pinze per dissezione



37-256-12
12 cm (4 3/4")

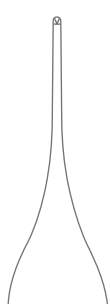

37-256-15
15 cm (6")

Micro-Adson Dissecting Forcep
1 x 2 Teeth

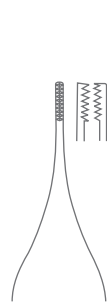

37-258-12
12 cm (5")

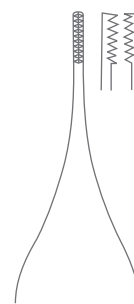

37-258-15
15 cm (6")

Adson-Brown Dissecting Forcep
7 x 7 Teeth



Dissecting Forceps
Anatomische Pinzetten
Pinzas de disección
Pincès à dissection
Pinze per dissezione



37-260-12
Adson-Brown Dissecting Forcep
9 x 9 Teeth
Overall Length 12 cm (5")

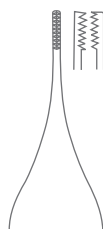

Brown Dissecting Forcep
7 x 7 Teeth

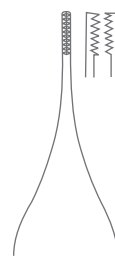

37-260-15
15.5 cm (6 1/4")

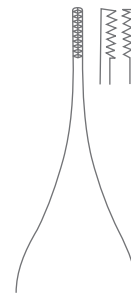

37-260-20
20 cm (7")

Dissecting Forceps
Anatomische Pinzetten
Pinzas de disección
Pincès à dissection
Pinze per dissezione

37

FORCEPS



37-270-15
Gillies Dissecting Forcep
1 x 2 Teeth, Cross Serrated
Overall Length 15.5 cm (6")



1:2



Waugh Dissecting Forcep
1 x 2 Teeth, Cross Serrated



1:2



37-272-18
18 cm (7")



37-272-20
20.5 cm (8")



37-272-25
25 cm (10")



37-272-30
30.5 cm (12")

Dissecting Forceps
Anatomische Pinzetten
Pinzas de disección
Pincès à dissection
Pinze per dissezione



37-274-12
12.5 cm (5")

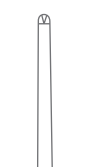

37-274-15
15.5 cm (6")



37-280-17
Taylor Dissecting Forcep
1 x 2 Teeth
Overall Length 17.5 cm (7")



37-282-17
Taylor Dissecting Forcep
1 x 2 Teeth, With Dissector End
Overall Length 17 cm (6 3/4")



Dissecting Forceps
Anatomische Pinzetten
Pinzas de disección
Pincés à dissection
Pinze per dissezione

37

FORCEPS



37-283-17
Taylor Dissecting Forcep
1 x 2 Teeth, Bayonet Shaped
Overall Length 18.5 cm (7 1/4")



37-286-06
0.6 mm

37-286-08
0.8 mm

37-286-10
1.0 mm

Dissecting Forcep
1 x 2 Teeth
Overall Length 15.5 cm (6")



Dissecting Forceps
Anatomische Pinzetten
Pinzas de disección
Pincès à dissection
Pinze per dissezione



Gerald Dissecting Forcep
1 x 2 Teeth



37-290-17
Straight
17.5 cm (7")

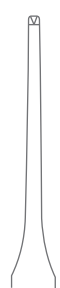

37-290-23
Straight
23 cm (9")

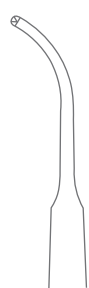

37-291-17
Curved
17.5 cm (7")



Cushing Dissecting Forcep
1 x 2 Teeth



37-294-18
18 cm (7")



37-294-21
21 cm (8 1/4")



37-294-25
24 cm (9 1/2")

Dissecting Forceps
Anatomische Pinzetten
Pinzas de disección
Pincès à dissection
Pinze per dissezione

37

FORCEPS



37-296-18
18 cm (7")



37-296-21
21 cm (8 ¼")



37-296-25
24 cm (9 ½")



37-298-15
McIndoe Dissecting Forcep
1 x 2 Teeth
Overall Length 15 cm (6")



37-300-20
Brophy Dissecting Forcep
1 x 2 Teeth
Overall Length 20 cm (8")



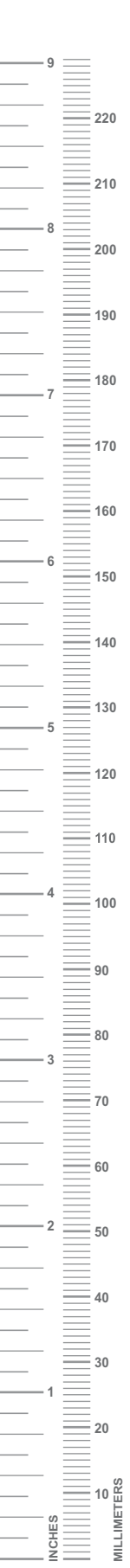

Dissecting Forceps
Anatomische Pinzetten
Pinzas de disección
Pinces à dissection
Pinze per dissezione

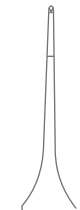

37-302-09
1 x 2 Teeth
With Plateau
9.5 cm (3 3/4")

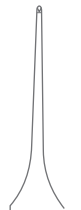

37-302-09
1 x 2 Teeth
10.5 cm (4")



Bonner-Modell Dissecting Forcep



37-305-02
Angled



37-305-03
Angled

Micro Vessel Dilator
Overall Length 11 cm (4 1/4")



37-306-13
Straight
13.5 cm (5 1/2")



37-306-18
Curved
18 cm (7")



37-307-13
Straight
13.5 cm (5 1/2")



37-307-18
Curved
18 cm (7")

Micro Vessel Dilator

Jeweller Type Forceps
Uhrmacher-Pinzetten
Pinzas de relojero
Pinces d'horloger
Pinze da orologiaio

FORCEPS



37-310-01
Jeweller Forcep
Fig. 1
Overall Length 12 cm (5")



37-310-02
Jeweller Forcep
Fig. 2
Overall Length 12 cm (5")



37-310-03
Jeweller Forcep
Fig. 3
Overall Length 12 cm (4 ¾")



37-310-04
Jeweller Forcep
Fig. 4
Overall Length 11 cm (4 ¼")



Jeweller Type Forceps
Uhrmacher-Pinzetten
Pinzas de relojero
Pinces d'horloger
Pinze da orologiaio



37-310-05
Jeweller Forcep
Fig. 5
Overall Length 11 cm (4 1/4")



37-310-07
Jeweller Forcep
Fig. 7
Overall Length 12 cm (4 3/4")



37-310-13
Jeweller Forcep
Fig. 3C
Overall Length 11 cm (4 1/4")



37-310-15
Jeweller Forcep
Fig. 5A
Overall Length 11 cm (4 1/4")

Jeweller Type Forceps
Uhrmacher-Pinzetten
Pinzas de relojero
Pincès d'horloger
Pinze da orologiaio

FORCEPS



37-310-45
Jeweller Forcep
Fig. 5/45°
Overall Length 10.5 cm (4 1/4")



37-310-90
Jeweller Forcep
Fig. 5/90°
Overall Length 10.5 cm (4 1/4")



37-313-13
Jeweller Forcep
1 x 2 Teeth, 0.4 mm
Overall Length 11.5 cm (4 1/2")





Jeweller Type Forceps
Uhrmacher-Pinzetten
Pinzas de relojero
Pinces d'horloger
Pinze da orologiaio



37-316-13
Jeweller Forcep
0.3 mm
Overall Length 13.5 cm (5 1/4")

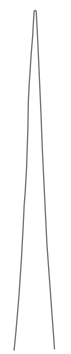

37-318-13
Jeweller Forcep
1 x 2 Teeth, 0.4 mm
Overall Length 13.5 cm (5 1/4")



37-320-12
Jeweller Forcep
Straight, With Plateau, 0.3 mm
Overall Length 12 cm (3 3/4")

Jeweller Type Forceps, Micro Dilating Forceps
 Uhrmacher-Pinzetten, Gefäß-Dilatationspinzetten
 Pinzas de relojero, Micro pinza de dilatación
 Pinces d'horloger, Micro pince à dilater
 Pinze da orologiaio, Micro pinze per dilatazione



37-322-13
 Straight



37-323-13
 Curved



37-325-00
 Ø 0.20 mm
 Angled

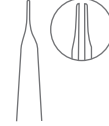

37-325-01
 Ø 0.30 mm
 Angled

Vise Micro Suturing Forcep
 With Plateau, 0.3 mm
 Overall Length 13.5 cm (5 1/4")

Micro Vessel Dilator
 Overall Length 11 cm (4 1/4")



37-325-02
 Ø 0.30 mm
 Angled

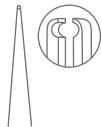

37-325-12
 Ø 0.20 mm
 Angled

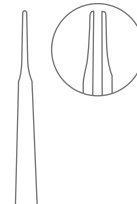

37-325-13
 Ø 0.30 mm
 Angled

Micro Vessel Dilator
 Overall Length 11 cm (4 1/4")

Micro Vessel Dilator
 Overall Length 13 cm (5")



Micro Dilating Forceps
Gefäß-Dilatationspinzetten
Micro pinza de dilatación
Micro pince à dilater
Micro pinze per dilatazione



Micro Vessel Dilator
Overall Length 18 cm (7")

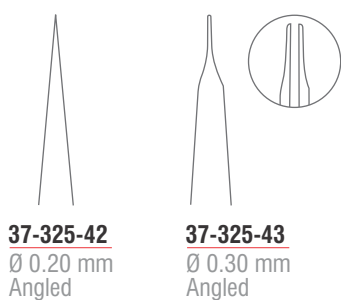

Micro Vessel Dilator
Overall Length 13 cm (5")

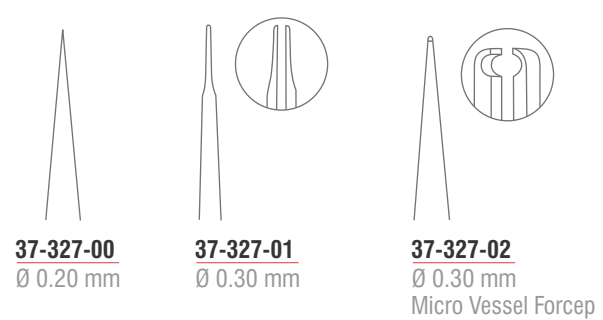

Micro Dilating Forceps, Tissue Forceps
 Gefäß-Dilatationspinzetten, Chirurgische Pinzetten
 Micro pinza de dilatación, Pinzas de disección con diente
 Micro pince à dilater, Pincés à dissection à griffes
 Micro pinze per dilatazione, Pinze per dissezione con denti

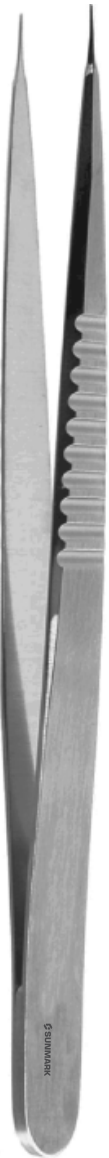

37-327-42
 Ø 0.20 mm
 Straight



37-327-43
 Ø 0.30 mm
 Straight



Micro Vessel Dilator
 Overall Length 18 cm (7")

37-328-15
Selman Dissecting Forcep
 Overall Length 15.5 cm (6")

Tissue Forceps
Chirurgische Pinzetten
Pinzas de disección con diente
Pinces à dissection à griffes
Pinze per dissezione con denti



Russian Modell Dissecting Forcep



37-330-15
15 cm (5")



37-330-20
20 cm (8")

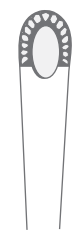

37-330-25
25.5 cm (10")



Durante Dissecting Forcep



37-332-14
14.5 cm (5 3/4")



37-332-16
16 cm (6 1/4")



37-332-20
20.5 cm (8")

Dissecting forceps
 Anatomische Pinzetten
 Pinzas de disección con diente
 Pinces à dissection à griffes
 Pinze per dissezione con denti

FORCEPS



Stille-Barraya Dissecting Forcep

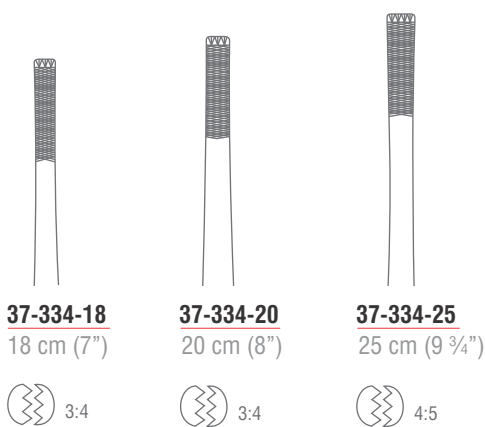

37-336-18
Ferris-Smith Dissecting Forcep
 2 x 3 Teeth
 Overall Length 18 cm (7")



Tissue Forceps
Chirurgische Pinzetten
Pinzas de disección con diente
Pinces à dissection à griffes
Pinze per dissezione con denti



37-338-18
Bonney Dissecting Forcep
1 x 2 Teeth
Overall Length 17.5 cm (7")



37-340-18
Mayo (Russian) Dissecting Forcep
Overall Length 23 cm (9")



Singley-Tuttle Dissecting Forcep

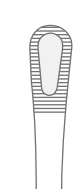

37-344-18
18 cm (7")

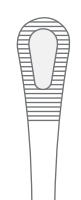

37-344-23
23 cm (9")

Tissue Forceps
Chirurgische Pinzetten
Pinzas de disección con diente
Pincers à dissection à griffes
Pinze per dissezione con denti

FORCEPS



Collin-Duval Tissue Grasping Forcep
Overall Length 20 cm (8")



37-348-14
14.0 mm

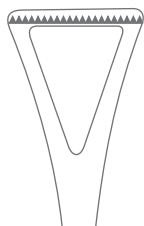

37-348-18
18.0 mm

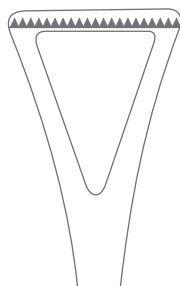

37-348-23
23.0 mm

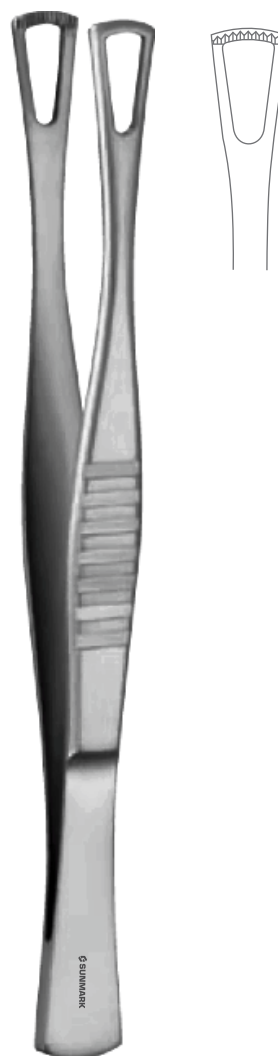

37-350-14
Duval Tissue Forcep
Overall Length 14 cm (5 1/2")



Tissue Forceps
 Chirurgische Pinzetten
 Pinzas de disección con diente
 Pinces à dissection à griffes
 Pinze per dissezione con denti



37-352-19
Dennis-Browne Intestinal Forcep
 Overall Length 19 cm (7 1/2")



37-354-15
 16 cm (6")

37-354-23
 23 cm (9")



Lane Dissecting Forcep

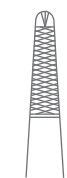

37-360-12
 1 x 2 Teeth
 12.5 cm (5")



37-360-14
 1 x 2 Teeth
 14.5 cm (5 3/4")

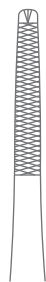

37-360-17
 1 x 2 Teeth
 17.5 cm (7")



37-362-14
 2 x 3 Teeth
 14.5 cm (5 3/4")



37-362-17
 2 x 3 Teeth
 17.5 cm (7")

Tissue Forceps
Chirurgische Pinzetten
Pinzas de disección con diente
Pincès à dissection à griffes
Pinze per dissezione con denti

FORCEPS

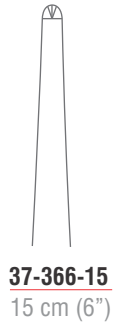
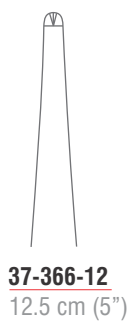

Treves Dissecting Forcep
1 x 2 Teeth



Ramsey Dissecting Forcep
Overall Length 18 cm (7")



Tissue Forceps
Chirurgische Pinzetten
Pinzas de disección con diente
Pinces à dissection à griffes
Pinze per dissezione con denti



Strassburger Modell Dissecting Forcep
1 x 2 Teeth



37-374-15
15 cm (6")



37-374-20
20 cm (8")



37-376-14
Jackson-Burrows Dissecting Forcep
1 x 2 Teeth, With Platform
Overall Length 14 cm (5 1/2")



37-378-18
Charnley Dissecting Forcep
1 x 2 Teeth, With Platform
Overall Length 18 cm (7")

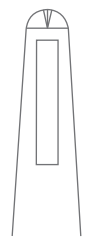

Micro Forceps
Mikropinzetten
Micro Pinzas
Micro-Pinces
Micro-Pinze

FORCEPS



37-401-02
Right
Ø 3.0 mm

37-401-02
Left
Ø 3.0 mm

Samii Tumor Grasping Forcep
Bayonet Shaped
Overall Length 24 cm (9 1/2")



37-403-01
Ø 3.0 mm

37-403-02
Ø 5.0 mm

Yasargil Tumor Grasping Forcep
Bayonet Shaped
Overall Length 22 cm (8 3/4")



37-403-03
Ø 3.0 mm

37-403-04
Ø 5.0 mm

Yasargil Tumor Grasping Forcep
Bayonet Shaped
Overall Length 22 cm (8 3/4")



Micro Forceps
Mikropinzetten
Micro Pinzas
Micro-Pinces
Micro-Pinze



37-405-01
Ø 3.0 mm

37-405-02
Ø 5.0 mm

Heifetz Tumor Grasping Forcep
Bayonet Shaped
Overall Length 22 cm (8 3/4")



37-407-20
Hunt Tumor Grasping Forcep
Angled
Overall Length 20 cm (8")



37-409-01
Adson Hypophyseal Forcep
6.0 mm, Bayonet Shaped
Overall Length 23 cm (9")

Micro Forceps
 Mikropinzetten
 Micro Pinzas
 Micro-Pinces
 Micro-Pinze

FORCEPS

Yasargil Micro Forcep
 Bayonet Shaped



37-411-16
 0.6 mm
 16 cm (6 ¼")



37-411-18
 0.6 mm
 18 cm (7")



37-411-20
 0.6 mm
 20 cm (8")



37-411-22
 0.6 mm
 22 cm (8 ¾")



37-411-22
 0.6 mm
 24 cm (9 ½")



37-413-16
 0.9 mm
 16 cm (6 ¼")



37-413-18
 0.9 mm
 18 cm (7")



37-413-20
 0.9 mm
 20 cm (8")



37-413-22
 0.9 mm
 22 cm (8 ¾")



37-413-22
 0.9 mm
 24 cm (9 ½")

37-024-13
Diam-n-Dust™ Yasargil Micro Forcep
 Bayonet Shaped

Micro Forceps
Mikropinzetten
Micro Pinzas
Micro-Pinces
Micro-Pinze



Yasargil Micro Forcep
1 x 2 Teeth, Bayonet Shaped

37-415-16
Curved

37-415-18
Curved

37-415-20
Curved



Lazar Micro Suturing Forcep
Overall Length 15.5 cm (6")

37-420-05
0.5 mm

37-420-08
0.8 mm

Grasping Forceps
 Fasspinzetten
 Pinzas para coger
 Pincas pour saisir les tissus
 Pinze per afferrare tessuti

FORCEPS

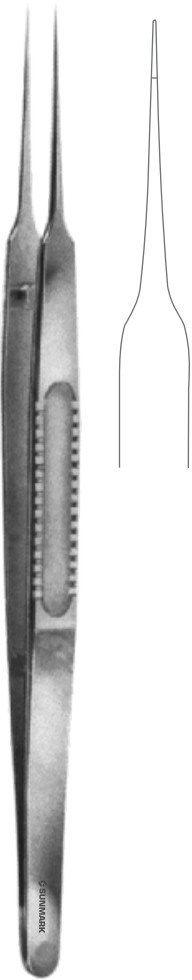

37-422-18
Micro Suturing Forcep
 0.5 mm, With Platform
 Overall Length 18.5 cm (7 1/4")



37-424-14
Austin Micro Suturing Forcep
 0.8 mm, With Platform
 Overall Length 14 cm (5 1/2")





Micro Forceps
Mikropinzetten
Micro Pinzas
Micro-Pinces
Micro-Pinze



Micro Suturing Forcep
With Platform

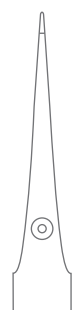

37-430-12
0.3 mm
Straight
12 cm (4 3/4")

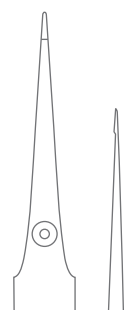

37-430-15
0.3 mm
Straight
15 cm (6")



37-431-12
0.3 mm
Curved
12 cm (4 3/4")

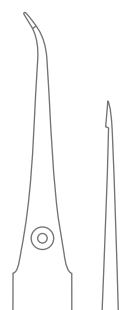

37-431-12
0.3 mm
Curved
15 cm (6")

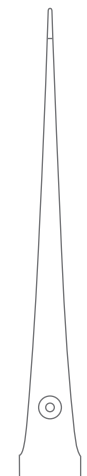

37-432-18
0.5 mm
Straight
18 cm (7")

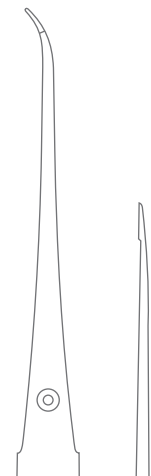

37-433-18
0.5 mm
Curved
18 cm (7")

Micro Forceps
Mikropinzetten
Micro Pinzas
Micro-Pinces
Micro-Pinze

FORCEPS



37-500-15

Straight
6.0 x 0.4 mm
15 cm (6")



37-500-18

Straight
6.0 x 0.4 mm
18 cm (7")



37-501-15

Curved
6.0 x 0.4 mm
15 cm (6")



37-501-18

Curved
6.0 x 0.4 mm
18 cm (7")



Diam-n-Dust™ Micro Dressing Forcep



37-500-15 T

Straight
6.0 x 0.4 mm
15 cm (6")



37-500-18 T

Straight
6.0 x 0.4 mm
18 cm (7")



37-501-15 T

Curved
6.0 x 0.4 mm
15 cm (6")



37-501-18 T

Curved
6.0 x 0.4 mm
18 cm (7")



Diam-n-Dust™ Micro Dressing Forcep
Titanium

Micro Forceps
 Mikropinzetten
 Micro Pinzas
 Micro-Pinces
 Micro-Pinze

37-504-15
 Straight
 6.0 x 0.7 mm
 15 cm (6")



37-504-18
 Straight
 6.0 x 0.7 mm
 18 cm (7")



37-504-21
 Straight
 6.0 x 0.7 mm
 21 cm (8 ¼")



37-504-23
 Straight
 6.0 x 0.7 mm
 23 cm (9")



37-505-15
 Curved
 6.0 x 0.7 mm
 15 cm (6")



37-505-18
 Curved
 6.0 x 0.7 mm
 18 cm (7")



37-505-21
 Curved
 6.0 x 0.7 mm
 21 cm (8 ¼")



37-505-23
 Curved
 6.0 x 0.7 mm
 23 cm (9")

Diam-n-Dust™ Micro Dressing Forcep

37-504-15 T
 Straight
 6.0 x 0.7 mm
 15 cm (6")



37-504-18 T
 Straight
 6.0 x 0.7 mm
 18 cm (7")



37-504-21 T
 Straight
 6.0 x 0.7 mm
 21 cm (8 ¼")



37-505-15 T
 Curved
 6.0 x 0.7 mm
 15 cm (6")



37-505-18 T
 Curved
 6.0 x 0.7 mm
 18 cm (7")







37-505-21 T
 Curved
 6.0 x 0.7 mm
 21 cm (8 ¼")

Diam-n-Dust™ Micro Dressing Forcep
 Titanium





Micro Forceps
 Mikropinzetten
 Micro Pinzas
 Micro-Pinces
 Micro-Pinze

FORCEPS











			
37-508-15	37-508-18	37-509-15	37-509-18
Straight	Straight	Curved	Curved
1 x 2 Teeth	1 x 2 Teeth	1 x 2 Teeth	1 x 2 Teeth
6.0 x 4.0 mm	6.0 x 4.0 mm	6.0 x 4.0 mm	6.0 x 4.0 mm
15 cm (6")	18 cm (7")	15 cm (6")	18 cm (7")

Diam-n-Dust™ Micro Dressing Forcep





			
37-508-15 T	37-508-18 T	37-509-15 T	37-509-18 T
Straight	Straight	Curved	Curved
1 x 2 Teeth	1 x 2 Teeth	1 x 2 Teeth	1 x 2 Teeth
6.0 x 4.0 mm	6.0 x 4.0 mm	6.0 x 4.0 mm	6.0 x 4.0 mm
15 cm (6")	18 cm (7")	15 cm (6")	18 cm (7")

Diam-n-Dust™ Micro Dressing Forcep
 Titanium

Micro Forceps
 Mikropinzetten
 Micro Pinzas
 Micro-Pinces
 Micro-Pinze

			
37-512-15 Straight 1 x 2 Teeth 6.0 x 0.7 mm 15 cm (6")	37-512-18 Straight 1 x 2 Teeth 6.0 x 0.7 mm 18 cm (7")	37-512-21 Straight 1 x 2 Teeth 6.0 x 0.7 mm 21 cm (8 ¼")	37-512-23 Straight 1 x 2 Teeth 6.0 x 0.7 mm 23 cm (9")
			
37-513-15 Curved 1 x 2 Teeth 6.0 x 0.7 mm 15 cm (6")	37-513-18 Curved 1 x 2 Teeth 6.0 x 0.7 mm 18 cm (7")	37-513-21 Curved 1 x 2 Teeth 6.0 x 0.7 mm 21 cm (8 ¼")	37-513-23 Curved 1 x 2 Teeth 6.0 x 0.7 mm 23 cm (9")

Diam-n-Dust™ Micro Dressing Forcep

		
37-512-15 T Straight 1 x 2 Teeth 6.0 x 0.7 mm 15 cm (6")	37-512-18 T Straight 1 x 2 Teeth 6.0 x 0.7 mm 18 cm (7")	37-512-21 T Straight 1 x 2 Teeth 6.0 x 0.7 mm 21 cm (8 ¼")
		
37-513-15 T Straight 1 x 2 Teeth 6.0 x 0.7 mm 15 cm (6")	37-513-18 T Straight 1 x 2 Teeth 6.0 x 0.7 mm 18 cm (7")	37-513-21 T Curved 1 x 2 Teeth 6.0 x 0.7 mm 21 cm (8 ¼")

Diam-n-Dust™ Micro Dressing Forcep
 Titanium

Micro Forceps
 Mikropinzetten
 Micro Pinzas
 Micro-Pinces
 Micro-Pinze

FORCEPS



37-516-15
 Ø 1.0 x 0.5 mm
 15 cm (6")



37-516-18
 Ø 1.0 x 0.5 mm
 18 cm (7")



37-516-21
 Ø 1.0 x 0.5 mm
 21 cm (8 ¼")



37-516-23
 Ø 1.0 x 0.5 mm
 23 cm (9")



37-518-15
 Ø 2.0 x 1.0 mm
 15 cm (6")



37-518-18
 Ø 2.0 x 1.0 mm
 18 cm (7")



37-518-21
 Ø 2.0 x 1.0 mm
 21 cm (8 ¼")

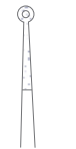

37-518-23
 Ø 2.0 x 1.0 mm
 23 cm (9")



Diam-n-Dust™ Micro Ring Forcep



37-516-15 T
 Ø 1.0 x 0.5 mm
 15 cm (6")



37-516-18 T
 Ø 1.0 x 0.5 mm
 18 cm (7")



37-516-21 T
 Ø 1.0 x 0.5 mm
 21 cm (8 ¼")



37-518-15 T
 Ø 2.0 x 1.0 mm
 15 cm (6")



37-518-18 T
 Ø 2.0 x 1.0 mm
 18 cm (7")



37-518-21 T
 Ø 2.0 x 1.0 mm
 21 cm (8 ¼")



Diam-n-Dust™ Micro Ring Forcep
 Titanium

Micro Forceps
Mikropinzetten
Micro Pinzas
Micro-Pinces
Micro-Pinze



Micro Atrauma Forcep

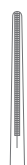

37-520-15
1.2 mm
15 cm (6")



37-520-18
1.2 mm
18 cm (7")

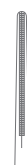

37-520-21
1.2 mm
21 cm (8 ¼")



**Micro Atrauma Forcep
Titanium**

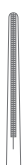

37-520-15 T
1.2 mm
15 cm (6")

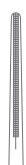

37-520-18 T
1.2 mm
18 cm (7")



37-520-21 T
1.2 mm
21 cm (8 ¼")



Micro Forceps
Mikropinzetten
Micro Pinzas
Micro-Pinces
Micro-Pinze

37

FORCEPS



37-522-00
Straight
Ø 0.4 mm



37-522-01
Curved
Ø 0.4 mm



37-522-02
Angled
Ø 0.4 mm



FR-522-03
Ø 1.0 x 0.5 mm



 **Diam-n-GRIP**

 **Diam-n-GRIP**

Diam-n-Dust™ Micro Suturing Forcep
Overall Length 15 cm (6")

Diam-n-Dust™ Micro Ring Forcep
Overall Length 15 cm (6")

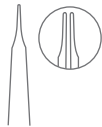

FR-524-04
Micro Vessel Dilator
Ø 0.3 mm
Overall Length 15 cm (6")

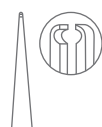

FR-524-05
Micro Pierce Dilator
Ø 0.4 mm
Overall Length 15 cm (6")



Micro Forceps
Mikropinzetten
Micro Pinzas
Micro-Pinces
Micro-Pinze



37-526-00
Micro Vessel Dilator
Ø 0.3 mm
With Counter Balance
Overall Length 15 cm (6")



37-526-01
Micro Pierce Dilator
Ø 0.3 mm
With Counter Balance
Overall Length 15 cm (6")



37-528-00
Micro Vessel Dilator
Ø 0.3 mm
With Counter Balance
Overall Length 18 cm (7")



37-528-01
Micro Pierce Dilator
Ø 0.3 mm
With Counter Balance
Overall Length 18 cm (7")

Micro Forceps
 Mikropinzetten
 Micro Pinzas
 Micro-Pinces
 Micro-Pinze

37

FORCEPS



37-530-15
 Ø 1.0 mm
 15 cm (6")



37-530-18
 Ø 1.0 mm
 18.5 cm (7 ¼")



37-530-21
 Ø 1.0 mm
 21 cm (8 ¼")



37-530-23
 Ø 1.0 mm
 23 cm (9")



37-530-25
 Ø 1.0 mm
 25 cm (9 ¾")



37-531-15
 Ø 1.0 mm
 15 cm (6")



37-531-18
 Ø 1.0 mm
 18.5 cm (7 ¼")



37-531-21
 Ø 1.0 mm
 21 cm (8 ¼")



37-531-23
 Ø 1.0 mm
 23 cm (9")



37-531-25
 Ø 1.0 mm
 25 cm (9 ¾")



Diam-n-Dust™ Micro Ring Forcep
 Straight, With Counter Balance





Micro Forceps
Mikropinzetten
Micro Pinzas
Micro-Pinces
Micro-Pinze



37-534-18
Diam-n-Dust™ Micro Ring Forcep
Straight, Ø 2.0 mm
With Counter Balance
Overall Length 18.5 cm (7 ¼")



Diam-n-Dust™ Micro Suturing Forcep
With Counter Balance



37-536-15
Straight
15 cm (6")



37-537-15
Curved
15 cm (6")



37-536-18
Straight
18.5 cm (7 ¼")



37-537-18
Curved
18.5 cm (7 ¼")



37-536-21
Straight
21 cm (8 ¼")



37-537-21
Curved
21 cm (8 ¼")



37-536-25
Straight
25 cm (9 ¾")



37-537-25
Curved
25 cm (9 ¾")

Micro Forceps
Mikropinzetten
Micro Pinzas
Micro-Pinces
Micro-Pinze



37-540-18
1.2 mm
18.5 cm (7 ¼")



37-540-21
1.2 mm
21 cm (8 ¼")



37-540-18 T
1.2 mm
18.5 cm (7 ¼")



Micro Atrauma Forcep
With Counter Balance

Micro Atrauma Forcep
With Counter Balance
Titanium



TITANIUM



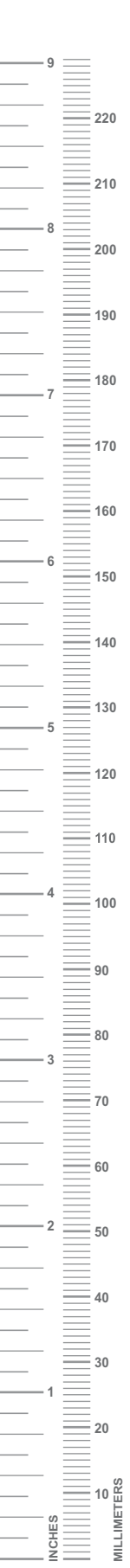

Micro Forceps
Mikropinzetten
Micro Pinzas
Micro-Pinces
Micro-Pinze



Diam-n-Dust™ Micro Ring Forcep



37-550-18
Ø 1.0 mm
Straight
With Long Platform
18.5 cm (7 ¼")



37-550-21
Ø 1.0 mm
Straight
With Long Platform
21 cm (8 ¼")



37-551-18
Ø 1.0 mm
Curved
With Long Platform
18.5 cm (7 ¼")



37-551-21
Ø 1.0 mm
Curved
With Long Platform
21 cm (8 ¼")



37-552-18
Ø 1.0 mm
Straight
With Short Platform
18.5 cm (7 ¼")



37-552-21
Ø 1.0 mm
Straight
With Short Platform
21 cm (8 ¼")



37-554-18
Ø 1.0 mm
Straight
18.5 cm (7 ¼")



37-554-21
Ø 1.0 mm
Curved
21 cm (8 ¼")

Micro Forceps
Mikropinzetten
Micro Pinzas
Micro-Pinces
Micro-Pinze

37

FORCEPS



37-556-18
1.2 mm
18.5 cm (7 1/4")



37-556-18
1.2 mm
21 cm (8 1/4")

Micro Atrauma Forcep
Straight



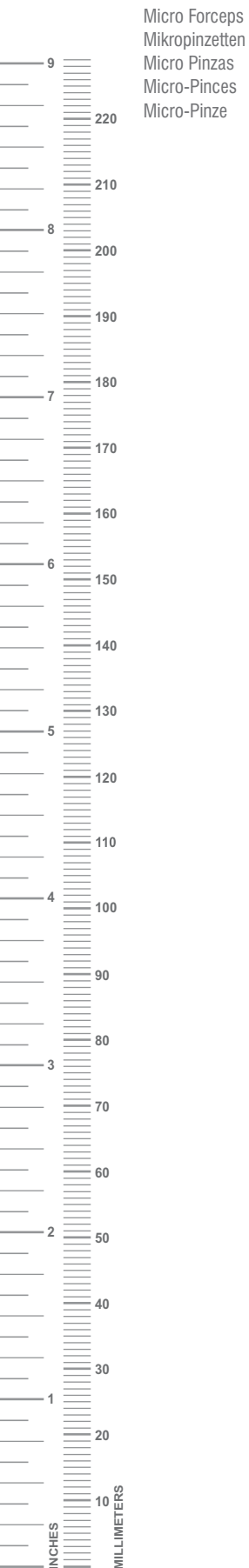

Micro Forceps
Mikropinzetten
Micro Pinzas
Micro-Pinces
Micro-Pinze



Gerald Micro Forcep
Cross Serrated Jaws

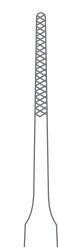

37-558-18
1.0 mm
18 cm (7")

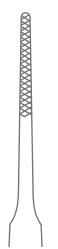

37-558-25
1.0 mm
25 cm (9 3/4")



Gerald (DeBakey) Micro Atrauma Forcep
Cross Serrated Jaws



37-560-18
1.0 mm
18 cm (7")



37-560-21
1.0 mm
20 cm (8")

Micro Forceps
Mikropinzetten
Micro Pinzas
Micro-Pinces
Micro-Pinze

FORCEPS



37-562-18
1.0 mm



37-563-18
1.0 mm



37-566-18
1.0 mm
18 cm (7")



37-566-20
1.0 mm
20 cm (8")



37-566-18 T
1.0 mm



Diam-n-Dust™ Gerald Micro Ring Forcep
Overall Length 18 cm (7")

Diam-n-Dust™ Gerald Micro Suturing Forcep

Diam-n-Dust™ Gerald Micro Suturing Forcep
Titanium
Overall Length 18 cm (7")



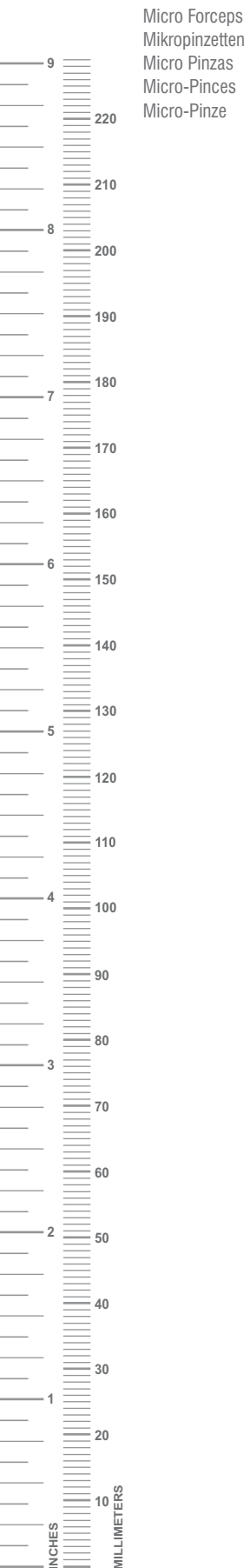

37-568-20
Micro Dressing Forcep
Cross Serrated Jaws
Overall Length 20 cm (8")



Resano Forcep Multi-Toothed



37-570-18
18 cm (7")



37-570-23
23 cm (9")



37-570-32
32 cm (12 ½")

Vascular Forceps
Gefäßpinzetten
Pinzas de disección vascular
Pincès à dissection vasculaires
Pinze per dissezione vascolari

FORCEPS



37-580-15
1.2 mm
15 cm (6")

37-582-20
1.5 mm
20 cm (8")

37-582-24
1.5 mm
24 cm (9 1/2")

37-582-30
1.5 mm
30 cm (11 3/4")

DeBakey Atrauma Forcep
Ultra Light Pattern

Vascular Forceps
 Gefäßpinzetten
 Pinzas de disección vascular
 Pinces à dissection vasculaires
 Pinze per dissezione vascolari



DeBakey Atrauma Forcep



37-584-15
 1.2 mm
 15 cm (6")



37-584-20
 1.2 mm
 20 cm (8")



37-584-24
 1.2 mm
 24 cm (9 1/2")



DeBakey Atrauma Forcep



37-590-16
 1.5 mm
 16 cm (6 1/4")



37-590-20
 1.5 mm
 20 cm (8")

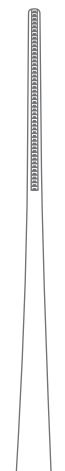

37-590-24
 1.5 mm
 24.5 cm (9 3/4")



37-590-30
 1.5 mm
 30 cm (11 3/4")

Vascular Forceps
 Gefäßpinzetten
 Pinzas de disección vascular
 Pinces à dissection vasculaires
 Pinze per dissezione vascolari

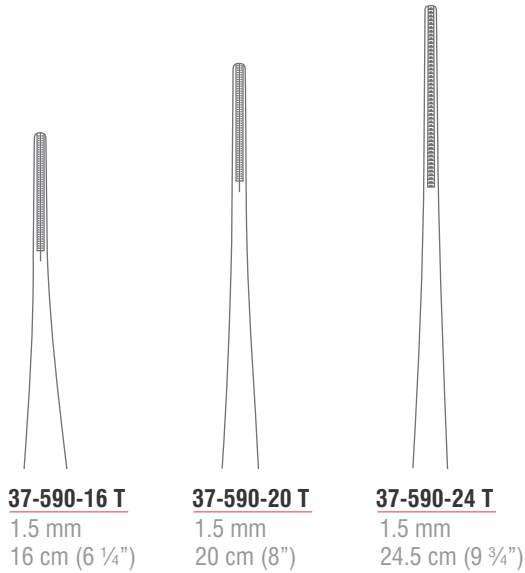

37-590-16 T
 1.5 mm
 16 cm (6 ¼")

37-590-20 T
 1.5 mm
 20 cm (8")

37-590-24 T
 1.5 mm
 24.5 cm (9 ¾")



TITANIUM

DeBakey Atrauma Forcep
 Titanium

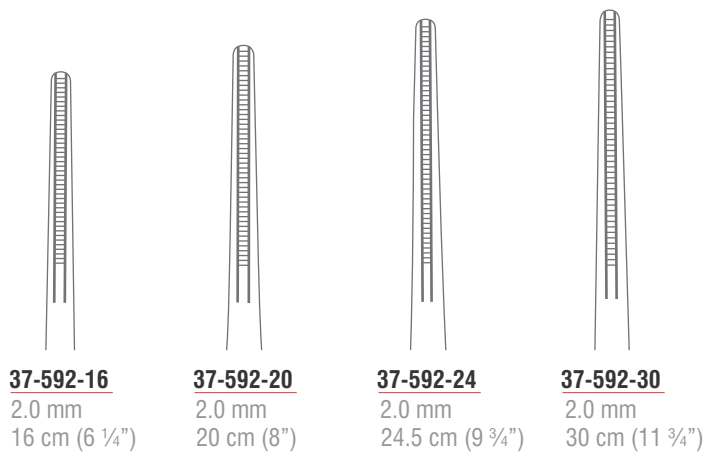

37-592-16
 2.0 mm
 16 cm (6 ¼")

37-592-20
 2.0 mm
 20 cm (8")

37-592-24
 2.0 mm
 24.5 cm (9 ¾")

37-592-30
 2.0 mm
 30 cm (11 ¾")

DeBakey Atrauma Forcep

Vascular Forceps
Gefäßpinzetten
Pinzas de disección vascular
Pinces à dissection vasculaires
Pinze per dissezione vascolari

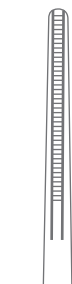

37-592-16 T
2.0 mm
16 cm (6 1/4")



37-592-20 T
2.0 mm
20 cm (8")



37-592-24 T
2.0 mm
24.5 cm (9 3/4")



TITANIUM

DeBakey Atrauma Forcep
Titanium



37-593-16
2.0 mm
16 cm (6 1/4")



37-593-20
2.0 mm
19.5 cm (7 3/4")

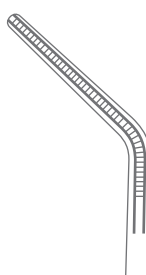

37-593-24
2.0 mm
24.5 cm (9 3/4")

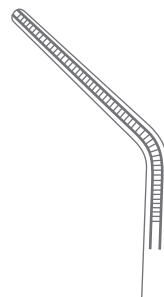





37-593-30
2.0 mm
29.5 cm (11 1/2")





DeBakey Atrauma Forcep
Angled

Vascular Forceps
 Gefäßpinzetten
 Pinzas de disección vascular
 Pinces à dissection vasculaires
 Pinze per dissezione vascolari

FORCEPS

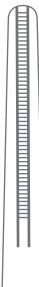
			
<u>37-594-16</u> 2.8 mm 16 cm (6 ¼")	<u>37-594-20</u> 2.8 mm 20 cm (8")	<u>37-594-24</u> 2.8 mm 24.5 cm (9 ¾")	<u>37-594-30</u> 2.8 mm 30 cm (11 ¾")

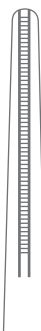
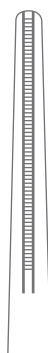
DeBakey Atrauma Forcep



				
<u>37-596-16</u> 3.5 mm 16 cm (6 ¼")	<u>37-596-20</u> 3.5 mm 20 cm (8")	<u>37-596-24</u> 3.5 mm 24.5 cm (9 ¾")	<u>37-596-30</u> 3.5 mm 30 cm (11 ¾")	<u>37-596-35</u> 3.5 mm 35 cm (13 ¾")

DeBakey Atrauma Forcep



Vascular Forceps
Gefäßpinzetten
Pinzas de disección vascular
Pinces à dissection vasculaires
Pinze per dissezione vascolari

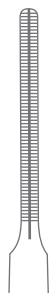

Cooley Atrauma Forcep

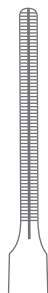

37-598-16
2.0 mm
16 cm (6 ¼")



37-598-20
2.0 mm
20 cm (8")



37-598-24
2.0 mm
24 cm (9 ½")

Splinter Forceps
Splitterpinzetten
Pinzas para espinas
Pinces à échardes
Pinze per scheggie

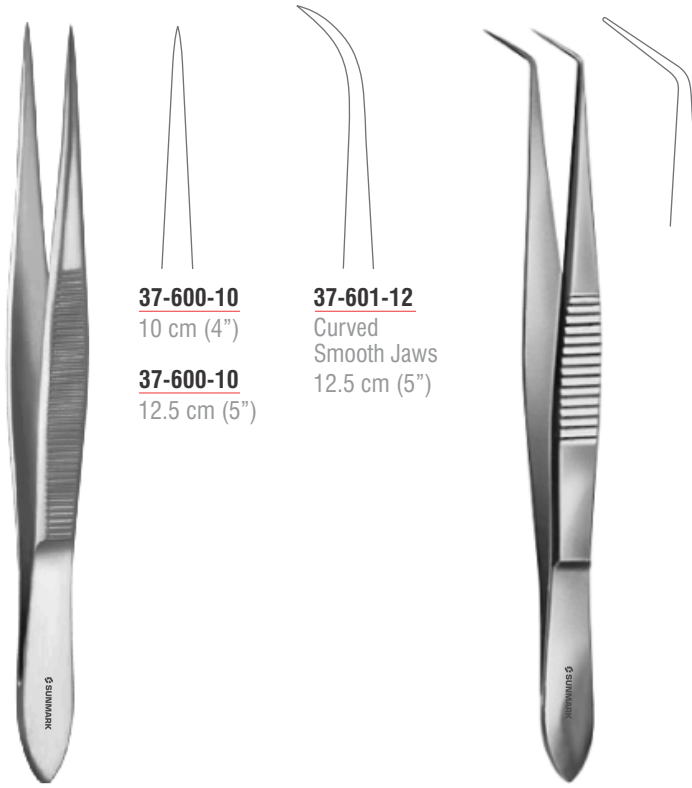

37-600-10

10 cm (4")

37-600-10

12.5 cm (5")

37-601-12

Curved
Smooth Jaws
12.5 cm (5")

Splinter Forcep
Straight, Smooth Jaws

37-603-10
Systrunk Nail Splitting Scissor
Angled, Smooth Jaws
Overall Length 10 cm (4")



37-606-09

Straight
9 cm (3 1/2")

37-606-10

Straight
10.5 cm (4")

37-606-11

Straight
11.5 cm (4 1/2")

37-606-13

Straight
13 cm (5")

37-606-14

Straight
14.5 cm (5 3/4")

37-607-09

Curved
9 cm (3 1/2")

37-607-10

Curved
10.5 cm (4")

37-607-11

Curved
11.5 cm (4 1/2")

37-607-13

Curved
13 cm (5")

37-607-14

Curved
14.5 cm (5 3/4")

Splinter Forcep
Serrated Jaws

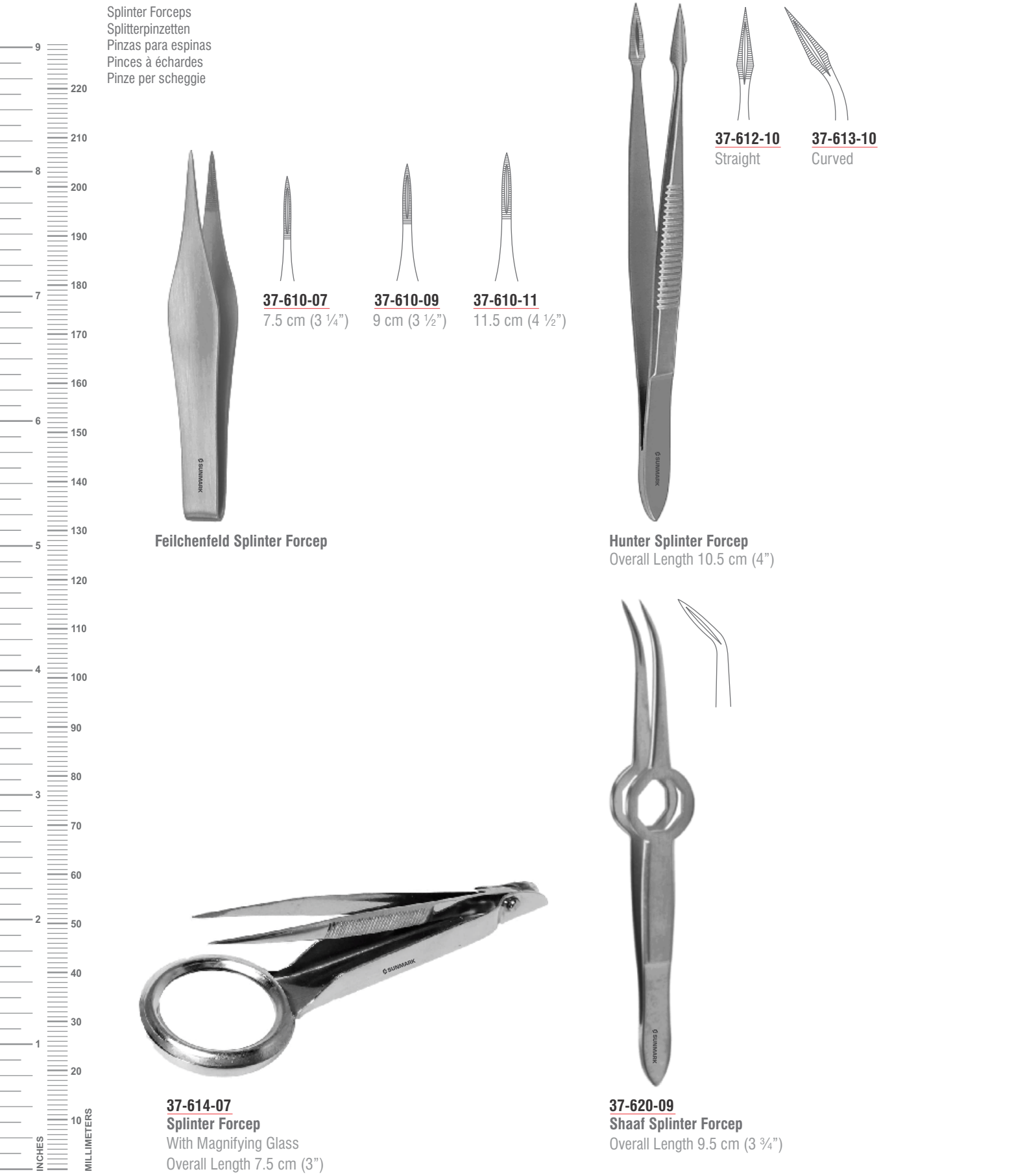

Splinter Forceps
Splitterpinzetten
Pinzas para espinas
Pincas à échardes
Pinze per scheggie



Feilchenfeld Splinter Forcep

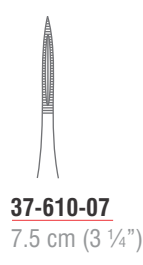

37-610-07
7.5 cm (3 1/4")

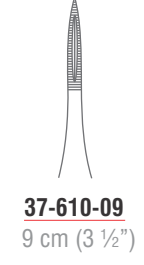

37-610-09
9 cm (3 1/2")

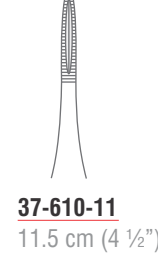

37-610-11
11.5 cm (4 1/2")



Hunter Splinter Forcep
Overall Length 10.5 cm (4")

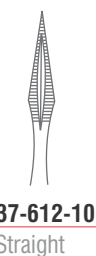

37-612-10
Straight

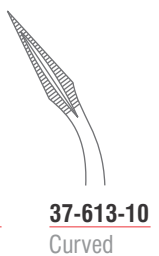

37-613-10
Curved



37-614-07
Splinter Forcep
With Magnifying Glass
Overall Length 7.5 cm (3")



37-620-09
Shaaf Splinter Forcep
Overall Length 9.5 cm (3 3/4")

Cilia Forceps
Zilienzange
Pinzas para cilios
Pinces à cils
Pinze Cilia



37-622-08
Littauer Cilia Forcep
Smooth Jaws
Overall Length 8.5 cm (3 1/4")



37-624-09
Bergh Cilia Forcep
Serrated Jaws
Overall Length 8.5 cm (3 1/4")



37-626-09
Douglas Cilia Forcep
Narrow Tip
Overall Length 9 cm (3 1/2")



37-628-09
Douglas Cilia Forcep
Wide Tip
Overall Length 9 cm (3 1/2")



37-630-09
Beer Cilia Forcep
Smooth Jaws
Overall Length 9 cm (3 1/2")



Barraquer Cilia Forcep
Overall Length 10.5 cm (4")



37-632-10
Smooth Jaws



37-632-10
Cross Serrated Jaws

Splinter Forceps
Splitterpinzetten
Pinzas para espinas
Pinces à échardes
Pinze per scheggie



37-635-07
Single Use Barsewisch Anterior Chamber Forcep
Angled, With Tying Platform
Overall Length 7.5 cm (3")



Stieglitz Splinter Forcep



37-650-14
Straight
14 cm (5 1/2")

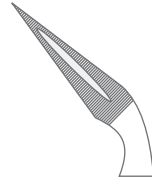

37-651-14
Curved
13.5 cm (5 1/4")



37-655-11
Peet Splinter Forcep
Overall Length 12.5 cm (5")



Ralk Splinter Forcep
Overall Length 15 cm (6")



37-660-15
Straight

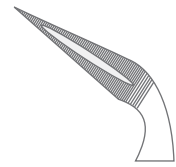

37-661-15
Curved

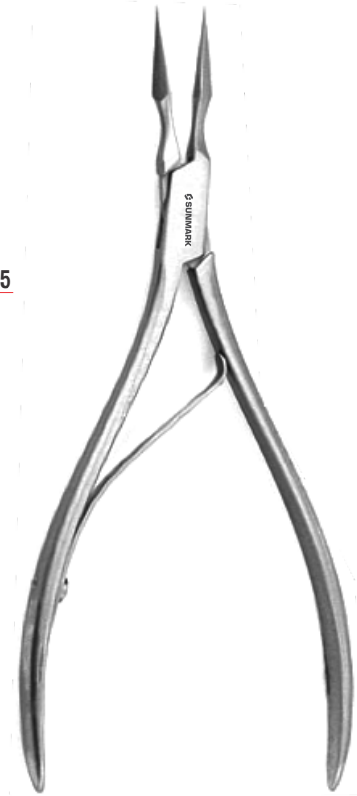

37-664-15
Vitus Splinter Forcep
Straight
Overall Length 15 cm (6")

Micro Forceps
Mikropinzetten
Micro Pinzas
Micro-Pinces
Micro-Pinze



Vitrectomy Forcep
14 cm (5 1/2")



37-680-20
Straight, Serrated Tip 20 G

37-680-23
Straight, Serrated Tip 23 G



37-682-20
Straight, End Grasping Jaws
Horizontal Opening Tip 20 G

37-682-23
Straight, End Grasping Jaws
Horizontal Opening Tip 23 G



37-685-20
Smooth Side, Gripping Jaws
Vertical Opening Tip 20 G



37-687-20
Membrane Peeling, Smooth
45° Angled Jaws, 20 G



37-689-23
Asymmetrical Jaws 23 G



37-690-23
ILM 23 G

Micro Forceps
Mikropinzetten
Micro Pinzas
Micro-Pinces
Micro-Pinze

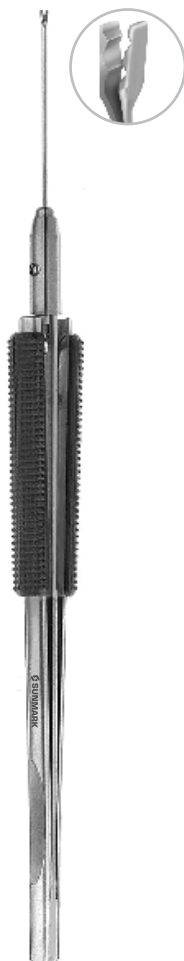

37-692-20
ICL Lens Cartridge Loading Forcep
Straight, 20 G
Jaws Feature a Series of Concave and Convex Surfaces

ICL® is a registered trademark of STAAR Surgical Company



37-695-23
Alio MICS Capsulorrhexis Forcep
23 G, Curved Shaft With Short Micro-Grasping Tip Designed For Use Through a Very Small Paracentesis.

Eye Surgery Forceps
Augenchirurgie Pinzetten
Ojo Pinzas Cirugia
Pince de chirurgie oculaire
Eye Pinze Chirurgia

FORCEPS



37-700-01
Straight
10 cm (4")



37-700-02
Gently Curved
10 cm (4")



37-700-03
Strongly Curved
9.5 cm (3 ¾")



37-702-01
Straight
10 cm (4")



37-702-02
Gently Curved
10 cm (4")



37-702-03
Strongly Curved
9.5 cm (3 ¾")



Graefe Eye Dressing Forcep
0.8 mm, Serrated Tips

Graefe Dissecting Forcep
0.8 mm, 1 x 2 Teeth

Eye Surgery Forceps
 Augenchirurgie Pinzetten
 Ojo Pinzas Cirugía
 Pince de chirurgie oculaire
 Eye Pinze Chirurgia



37-710-07
Botvin Iris Forcep
 0.5 mm, Serrated
 Overall Length 7.5 cm (3 1/4")



37-712-07
Botvin Iris Forcep
 0.3 mm, 1 x 2 Teeth
 Overall Length 7.5 cm (3 1/4")



37-714-07
Gills-Colibri Corneal Forcep
 Very Fine Pointed Tip, With Tying Platform
 Overall Length 7.5 cm (3 1/4")



37-716-07
Colibri Corneal Forcep
 Very Delicate, 1 x 2 Teeth, 0.12 mm
 Overall Length 7.5 cm (3 1/4")



37-718-07
Harms-Colibri Corneal Forcep
 Very Delicate, 1 x 2 Oblique Teeth
 0.12 mm With Tying Platform
 Overall Length 7.5 cm (3 1/4")

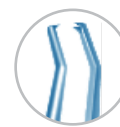

37-718-07 T
Harms-Colibri Corneal Forcep
 Very Delicate, 1 x 2 Oblique Teeth
 0.12 mm With Tying Platform
 Overall Length 7.5 cm (3 1/4")



Eye Surgery Forceps
Augenchirurgie Pinzetten
Ojo Pinzas Cirugia
Pince de chirurgie oculaire
Eye Pinze Chirurgia



37-720-07
Colibri Corneal Forcep
Standard 1 x 2 Teeth
With Tying Platform, 0.4 mm
Overall Length 7.5 cm (3 1/4")



37-721-07
Pierce-Colibri Corneal Forcep
1 x 1 Teeth, 0.12 mm
Overall Length 7.5 cm (3 1/4")



37-722-08
Hoskin Tissue Forcep
Straight, 1 x 1 Teeth, 0.3 mm
Overall Length 8 cm (3 1/4")



37-723-08
Hoskin Tissue Forcep
Curved, 1 x 1 Teeth, 0.3 mm
Overall Length 8 cm (3 1/4")



Eye Surgery Forceps
Augenchirurgie Pinzetten
Ojo Pinzas Cirugía
Pince de chirurgie oculaire
Eye Pinze Chirurgia



37-724-10
Fechtner Conjunctival Forcep
Very Delicate Ø 0.8 mm
Ring Shaped Tips
With 6 mm Long Tying Platform
Overall Length 10.5 cm (4")



37-726-11
Castroviejo-Colibri Corneal Forcep
Very Delicate 1 x 2 Teeth, 0.12 mm
Overall Length 11 cm (4 ¼")



37-728-11
Harms-Colibri Corneal Forcep
Very Delicate 1 x 2 Teeth, 0.12 mm
With Tying Platform
Overall Length 11 cm (4 ¼")



Eye Surgery Forceps
Augenchirurgie Pinzetten
Ojo Pinzas Cirugia
Pince de chirurgie oculaire
Eye Pinze Chirurgia



37-730-08
Bonn Corneal Forcep
Very Delicate 1 x 2 Teeth 0.12 mm
Overall Length 8.5 cm (4")



37-732-10
Bonn Corneal Forcep
Very Delicate 1 x 2 Teeth
With Tying Platform, 0.12 mm
Overall Length 10 cm (4")



37-732-10 T
Bonn Corneal Forcep
Very Delicate 1 x 2 Teeth
With Tying Platform, 0.12 mm, Titanium
Overall Length 10 cm (4")



37-734-08
Bonn Corneal Forcep
Very Delicate, Serrated
Overall Length 8.5 cm (3 1/4")

Eye Surgery Forceps
Augenchirurgie Pinzetten
Ojo Pinzas Cirugía
Pince de chirurgie oculaire
Eye Pinze Chirurgia



37-736-10
McPherson Suture Tying Forcep
Straight, 1 x 2 Teeth
With Tying Platform, 0.4 mm
Overall Length 10.5 cm (4")



37-737-10
McPherson Suture Tying Forcep
Angled, 1 x 2 Teeth
With Tying Platform, 0.4 mm
Overall Length 10 cm (4")



37-740-10
Kelman-McPherson Tissue Forcep
Angled, 1 x 2 Teeth
With Tying Platform, 0.3 mm
Overall Length 10 cm (4")



Eye Surgery Forceps
 Augenchirurgie Pinzetten
 Ojo Pinzas Cirugia
 Pince de chirurgie oculaire
 Eye Pinze Chirurgia

FORCEPS

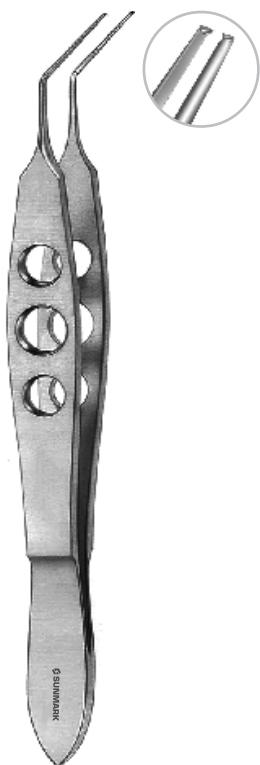

37-742-10
Hoffer-McPherson Tissue Forcep
 Very Delicate, 1 x 2 Teeth
 11 mm, 0.12 mm
 Overall Length 10 cm (4")



Castroviejo Suture Tying Forcep
 1 x 2 Oblique Teeth With Tying Platform
 Overall Length 11 cm (4 1/4")

- 37-750-01** 0.12 mm
- 37-750-03** 0.3 mm
- 37-750-05** 0.5 mm
- 37-750-09** 0.9 mm



37-750-01 T
Castroviejo Suture Tying Forcep
 1 x 2 Oblique Teeth, With Tying Platform
 0.12 mm, Titanium
 Overall Length 11 cm (4 1/4")



Eye Surgery Forceps
 Augen Chirurgie Pinzetten
 Ojo Pinzas Cirugia
 Pince de chirurgie oculaire
 Eye Pinze Chirurgia



Castroviejo Suture Tying Forcep
 Angled, 1 x 2 Oblique Teeth
 With Tying Platform
 Overall Length 11 cm (4 1/4")

- 37-751-01** 0.12 mm
- 37-751-03** 0.3 mm
- 37-751-05** 0.5 mm
- 37-751-09** 0.9 mm

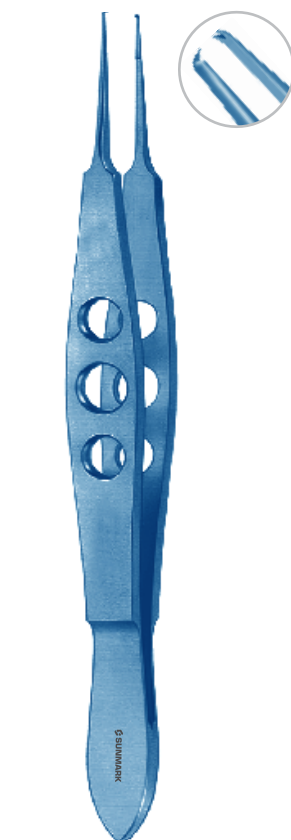

37-751-01 T
Castroviejo Suture Tying Forcep
 Angled, 1 x 2 Oblique Teeth With Tying Platform
 0.12 mm, Titanium
 Overall Length 11 cm (4 1/4")



37-752-05
Stern-Castroviejo Suture Tying Forcep
 1 x 2 Teeth, 0.5 mm
 Overall Length 11 cm (4 1/4")



Eye Surgery Forceps
Augenchirurgie Pinzetten
Ojo Pinzas Cirugia
Pince de chirurgie oculaire
Eye Pinze Chirurgia



37-754-10
Girard Corneoscleral Forceps
1 x 2 Teeth With Tying Platform
For Right Hand, 0.12 mm
Overall Length 10.5 cm (4")



37-756-10
Girard Corneoscleral Forceps
1 x 2 Teeth With Tying Platform
For Left Hand, 0.12 mm
Overall Length 10.5 cm (4")



37-758-08
0.3 mm Delicate
1 x 2 Teeth



37-760-08
0.8 mm Standard

Bishop-Harmon Iris Forceps
Overall Length 8.5 cm (3 1/4")



Eye Surgery Forceps
 Augenchirurgie Pinzetten
 Ojo Pinzas Cirugía
 Pince de chirurgie oculaire
 Eye Pinze Chirurgia



37-762-09
Bishop-Harmon Dressing Forcep
 0.8 mm, Cross Serrated Jaws
 Overall Length 8.5 cm (3 1/4")



37-764-09
St. Martin's Suture Tying Forcep
 0.3 mm, 1 x 2 Oblique Teeth
 With 5.0 mm Tying Platform
 Overall Length 9 cm (3 1/2")



37-765-09
Paufique Suture Tying Forcep
 0.5 mm, 1 x 2 Oblique Teeth
 With 5.0 mm Tying Platform
 Overall Length 9 cm (3 1/2")



37-766-09
Sauer Fixation Forcep
 0.3 mm, 1 x 2 Oblique Teeth
 Overall Length 9 cm (3 1/2")



Eye Surgery Forceps
 Augen Chirurgie Pinzetten
 Ojo Pinzas Cirugia
 Pince de chirurgie oculaire
 Eye Pinze Chirurgia

FORCEPS

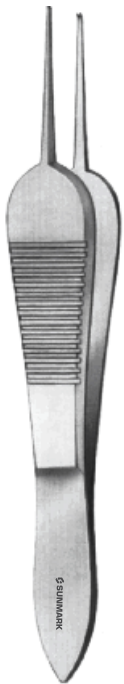

37-768-09
Manhattan Eye & Ear Fixation Forcep
 1 x 2 Teeth, 0.3 mm, With Tying Platform
 Overall Length 9 cm (3 1/2")



1:2



37-770-11
Elschnig Fixation Forcep
 0.9 mm, 1 x 2 Oblique Teeth
 Overall Length 11 cm (4 1/4")



1:2



37-772-01
Graefe Fixation Forcep
 4.5 mm Wide Jaws
 Without Lock
 Overall Length 11 cm (4 1/4")



37-772-02
Graefe Fixation Forcep
 4.5 mm Wide Jaws
 With Lock
 Overall Length 11 cm (4 1/4")

Eye Surgery Forceps
Augenchirurgie Pinzetten
Ojo Pinzas Cirugía
Pince de chirurgie oculaire
Eye Pinze Chirurgia



37-774-10
Green Fixation Forcep
9.0 mm Wide Jaws
Overall Length 10.5 cm (4")



37-774-11
Troutman Superior Rectus Forcep
Angled, 0.5 mm 1 x 2 Oblique Teeth
Overall Length 11 cm (4 1/4")



Lester Fixation Forcep
Overall Length 9.5 cm (3 3/4")



37-776-01
0.6 mm
1 x 2 Teeth



37-776-02
0.6 mm
2 x 3 Teeth



Eye Surgery Forceps
 Augenchirurgie Pinzetten
 Ojo Pinzas Cirugia
 Pince de chirurgie oculaire
 Eye Pinze Chirurgia

FORCEPS



37-777-01
Moody Fixation Forcep
 Curved Right
 Overall Length 11 cm (4 ¼")



37-777-02
Moody Fixation Forcep
 Curved Left
 Overall Length 11 cm (4 ¼")



37-780-10
McPherson Suture Tying Forcep
 Straight, With Tying Platform
 5.0 mm
 Overall Length 10 cm (4")

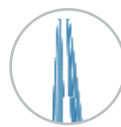

37-780-10 T
McPherson Suture Tying Forcep
 Straight, With Tying Platform
 5.0 mm Titanium
 Overall Length 10 cm (4")



TITANIUM



Eye Surgery Forceps
Augenchirurgie Pinzetten
Ojo Pinzas Cirugía
Pince de chirurgie oculaire
Eye Pinze Chirurgia



37-781-10
McPherson Suture Tying Forcep
Angled, With Tying Platform, 5 mm
Overall Length 10 cm (4")



37-781-10 T
McPherson Suture Tying Forcep
Angled, With Tying Platform, 5 mm Titanium
Overall Length 10 cm (4")



Eye Surgery Forceps
Augenchirurgie Pinzetten
Ojo Pinzas Cirugia
Pince de chirurgie oculaire
Eye Pinze Chirurgia



37-784-10
Kelman-McPherson Suture Tying Forcep
Angled, With Tying Platform, 7.5 mm
Overall Length 10 cm (4")

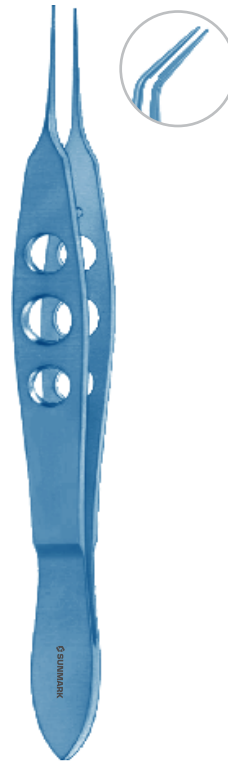

37-784-10 T
Kelman-McPherson Suture Tying Forcep
Angled, With Tying Platform, 7.5 mm Titanium
Overall Length 10 cm (4")



37-790-10
Kurstin Flap Stretching Forcep
Disc Shaped, Serrated Jaws
Overall Length 10.5 cm (4")



37-793-10
Buratto LASIK Flap Forcep
Curved, Disc Shaped, Serrated Jaws
Overall Length 10.5 cm (4")

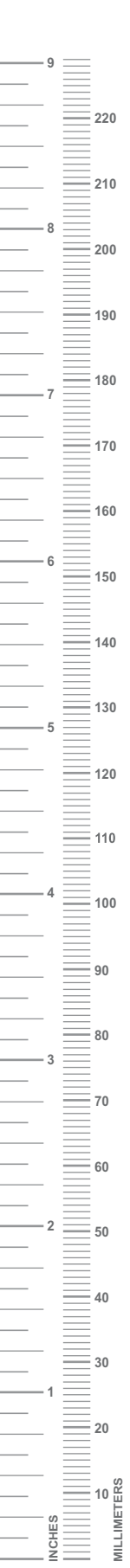

Eye Surgery Forceps
Augenchirurgie Pinzetten
Ojo Pinzas Cirugía
Pince de chirurgie oculaire
Eye Pinze Chirurgia



37-795-10
Mendez Multipurpose LASIK Forcep
Angled, Spatulated Jaws & Tip
Overall Length 10 cm (4")



37-797-10
Kraff Capsule Tag Forcep
Angled, 11 mm, 1.5 mm
Overall Length 10.5 cm (4")



37-801-10
Utrata Capsulorrhexis Forcep
Very Delicate Triangular Grasping Tips
Extremely Thin, 11 mm
Over Length 10.5 cm (4")

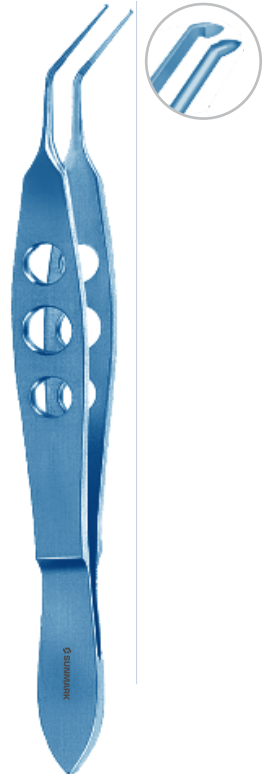

37-801-10 T
Utrata Capsulorrhexis Forcep
Very Delicate Triangular Grasping Tips
Extremely Thin, 11 mm, Titanium
Overall Length 10.5 cm (4")



Eye Surgery Forceps
Augenchirurgie Pinzetten
Ojo Pinzas Cirugia
Pince de chirurgie oculaire
Eye Pinze Chirurgia



37-803-10
Jaffe Capsulorrhexis Forcep
Very Delicate Round Grasping Tip
Extremely Thin, 11 mm
Overall Length 10.5 cm (4")



37-805-10
O'Gawa-Utrata Capsulorrhexis Forcep
Very Delicate, Round Grasping Tips
Extremely Thin
Overall Length 11.5 cm (4 ½")



37-807-11
Inamura Capsulorrhexis Forcep
Delicate Tapered 12 mm Long Shanks
Overall Length 11.5 cm (4 ½")



37-809-10
Masket Capsulorrhexis Forcep
With Very Delicate Triangle Grasping Tip & Very
Delicate Vaulted Shanks, Length 11 mm
Overall Length 11.5 cm (4 ½")

Eye Surgery Forceps
Augenchirurgie Pinzetten
Ojo Pinzas Cirugía
Pince de chirurgie oculaire
Eye Pinze Chirurgia



37-810-10
Jaffe Suture Tying Forcep
Straight, Very Delicate
Smooth Jaws, 6 mm
Overall Length 10.5 cm (4")



37-811-10
Jaffe Suture Tying Forcep
Curved, Very Delicate
Smooth Jaws, 6 mm
Overall Length 10.5 cm (4")



37-816-10
Tennant Suture Tying Forcep
Straight, Round Handle With
Guide Pin Extra Delicate
Smooth Jaws, 6 mm
Overall Length 10.5 cm (4")

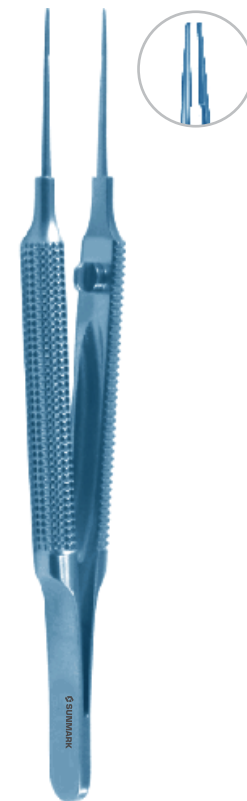

37-816-10 T
Tennant Suture Tying Forcep
Straight, Round Handle With
Guide Pin Extra Delicate Smooth
Jaws, 6 mm
Overall Length 10.5 cm (4")



TITANIUM

Eye Surgery Forceps
 Augenchirurgie Pinzetten
 Ojo Pinzas Cirugia
 Pince de chirurgie oculaire
 Eye Pinze Chirurgia

FORCEPS



37-817-10
Tennant Suture Tying Forcep
 Curved, Round Handle With
 Guide Pin, Extra Delicate Smooth
 Jaws, 6 mm
 Overall Length 10.5 cm (4")

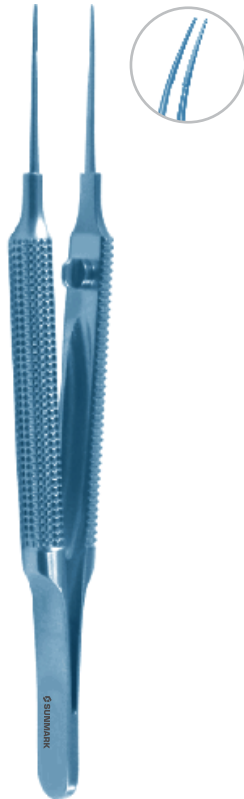

37-817-10 T
Tennant Suture Tying Forcep
 Curved, Round Handle With
 Guide Pin, Extra Delicate Smooth
 Jaws, 6 mm
 Titanium
 Overall Length 10.5 cm (4")



37-820-10
Harms Suture Tying Forcep
 Straight
 Overall Length 10.5 cm (4")



37-821-10
Harms Suture Tying Forcep
 Curved
 Overall Length 10.5 cm (4")



TITANIUM



Eye Surgery Forceps
Augenchirurgie Pinzetten
Ojo Pinzas Cirugía
Pince de chirurgie oculaire
Eye Pinze Chirurgia



37-824-10
Helveston Suture Tying Forcep
Straight
Overall Length 10.5 cm (4")



37-825-10
Fine Suture Tying Forcep
Curved
Overall Length 10.5 cm (4")



37-827-08
Gerl Suture Tying Forcep
Smooth Jaws, Curved Shanks, 6 mm
Overall Length 8.5 cm (3 1/4")

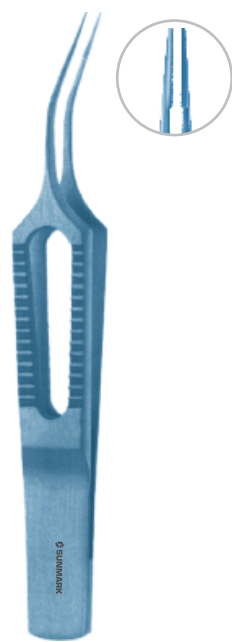

37-827-08 T
Gerl Suture Tying Forcep
Smooth Jaws, Curved Shanks, 6 mm
Titanium
Overall Length 8.5 cm (3 1/4")



Eye Surgery Forceps
Augenchirurgie Pinzetten
Ojo Pinzas Cirugia
Pince de chirurgie oculaire
Eye Pinze Chirurgia



37-830-10
Gradle Cilia Forcep
Smooth Jaws
Overall Length 10 cm (4")



Bonaccolto Conjunctival Forcep
Overall Length 10 cm (4")
37-834-12
Longitudinal Serrated Jaws
With Cross Serrated Tips, 1.2 mm

37-834-17
Longitudinal Serrated Jaws
With Cross Serrated Tips, 1.7 mm



37-836-10
Lister Conjunctival Forcep
1 x 2 Teeth
Overall Length 10 cm (4")



1:2



37-838-10
Moorfield Conjunctival Forcep
Overall Length 10 cm (4")



Eye Surgery Forceps
Augenchirurgie Pinzetten
Ojo Pinzas Cirugía
Pince de chirurgie oculaire
Eye Pinze Chirurgia



Nugent Utility Forcep
Overall Length 10 cm (4")
37-840-10
Smooth Jaws
37-842-10
Serrated Jaws



37-844-11
Lister Utility Forcep
Serrated Jaws, 1 x 2 Teeth
Overall Length 11 cm (4 1/4")



37-847-08
Scleral Plug Removing Forcep
Overall Length 8.5 cm - (3 1/2")



37-846-10
Gold Punctal Plug Forcep
With Longitudinal Groove
Pointed Tip
Overall Length 11 cm (4 1/4")

Eye Surgery Forceps
Augenchirurgie Pinzetten
Ojo Pinzas Cirugia
Pince de chirurgie oculaire
Eye Pinze Chirurgia

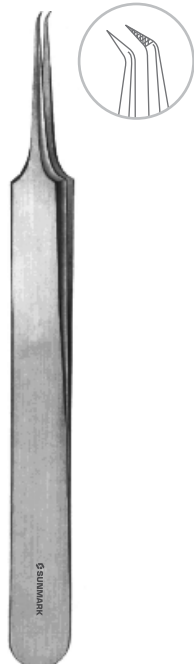

37-848-11
Osher Iris Forcep
Very Fine Textured Jaws
Overall Length 11 cm (4 1/4")



37-850-11
Foreign Body Forcep
Straight
Overall Length 8.5 cm (3 1/4")



37-855-11
Jaffe Utility Forcep
Curved, Very Delicate
Smooth Jaws
Overall Length 11 cm (4 1/4")



37-857-11
Castroviejo Capsule Forcep
Overall Length 11 cm (4 1/4")

FORCEPS



37-859-11
Arruga Capsule Forcep
Curved, Very Delicate
Overall Length 11 cm (4 1/4")

Eye Surgery Forceps
Augenchirurgie Pinzetten
Ojo Pinzas Cirugía
Pince de chirurgie oculaire
Eye Pinze Chirurgia



37-861-11
Akahoshi Phaco PreChopper
Delicate Jaws With Sharp Tip
4.5 mm
Overall Length 11 cm (4 1/4")



37-863-11
Ernest Nucleus Cracker
Extra Delicate Cross Action
Serrated Paddle Tip
Overall Length 11 cm (4 1/4")



37-867-11
Dodick Nucleus Cracker
Cross Action, Longitudinally
Serrated Paddle Shaped Jaws
Overall Length 11 cm (4 1/4")



37-869-10
Alfonso Nucleus Grasping Forcep
With Two Short Rows of Delicate
Interlocking Teeth
Overall Length 10.5 cm (4")

Eye Surgery Forceps
Augenchirurgie Pinzetten
Ojo Pinzas Cirugia
Pince de chirurgie oculaire
Eye Pinze Chirurgia

37

FORCEPS



37-871-11
**Rosenwasser Donor
Lamella Inserting Forcep**
With Vaulted Shanks
Overall Length 11 cm (4 1/4")



37-875-11
Dodick IOL Folding Forcep
For Short IOLs
Overall Length 11 cm (4 1/4")



37-877-10
Livernois IOL Folding Forcep
Concave Jaw Surfaces, For Soft IOLs
Overall Length 11 cm (4 1/4")



Eye Surgery Forceps
 Augenchirurgie Pinzetten
 Ojo Pinzas Cirugía
 Pince de chirurgie oculaire
 Eye Pinze Chirurgia



37-879-10
Steinert IOL Inserting Forcep
 Conically Shaped Jaws
 Overall Length 10 cm (4")



37-882-10
Livernois IOL Holding Forcep
 Straight, Highly Polished Round
 Jaws For Holding Soft IOLs
 Overall Length 10.5 cm (4")



37-883-10
Livernois IOL Holding Forcep
 Angled, Highly Polished Round
 Jaws For Holding Soft IOLs
 Overall Length 10.5 cm (4")

Eye Surgery Forceps
Augenchirurgie Pinzetten
Ojo Pinzas Cirugia
Pince de chirurgie oculaire
Eye Pinze Chirurgia



37-885-10
Livernois-McDonald IOL Inserting Forcep
Concave Jaws, 5.0 mm
Overall Length 10.5 cm (4")



37-887-10
Faulkner Lens Holding Forcep
Round, Smooth Jaws
Overall Length 10 cm (4")



37-889-10
Buratto IOL Inserting Forcep
Extra Delicate Highly Polished Convex Jaws
For Soft IOLs
Overall Length 10 cm (4")

Eye Surgery Forceps
Augenchirurgie Pinzetten
Ojo Pinzas Cirugía
Pince de chirurgie oculaire
Eye Pinze Chirurgia



37-891-12
Bechert Lens Holding Forcep
Very Delicate Flat Jaws
Overall Length 12.5 cm (5")



37-893-12
Kratz Lens Holding Forcep
Very Delicate Narrow Jaws
Overall Length 12.5 cm (5")



37-895-11
Blaydes Lens Holding Forcep
Very Delicate Narrow Jaws
Angled 45°
Overall Length 11.5 cm (4 ½")



37-897-12
Shepard Lens Holding Forcep
Gently Curved, Duckbill Shaped Jaws
Overall Length 12.5 cm (5")

Eye Surgery Forceps
Augenchirurgie Pinzetten
Ojo Pinzas Cirugia
Pince de chirurgie oculaire
Eye Pinze Chirurgia

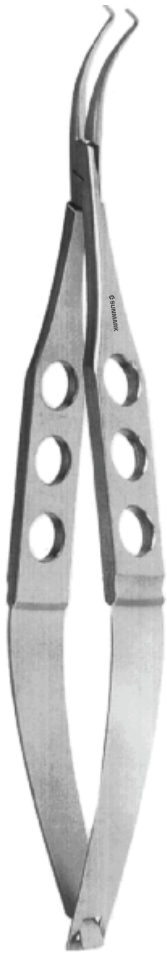

37-899-12
Clayman Lens Holding Forcep
Gently Curved, Blades With
Delicately Angled Jaws
Overall Length 12.5 cm (5")

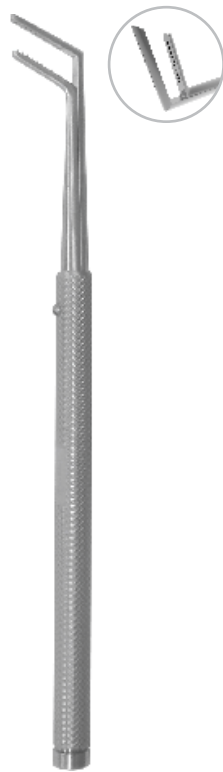

37-900-10
Bangerter Muscle Clamp
With 10 Delicate Teeth
and Push Button
Overall Length 10 cm (4")



37-901-01
Jameson Muscle Forcep
Right, With Slide Lock,
4 Teeth, Child Size
Overall Length 9.5 cm (3 ¾")

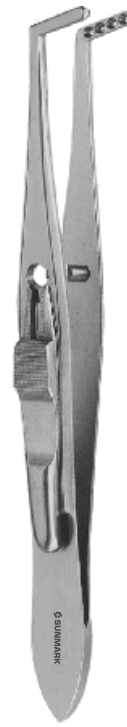

37-901-02
Jameson Muscle Forcep
Left, With Slide Lock,
4 Teeth, Child Size
Overall Length 9.5 cm (3 ¾")

Eye Surgery Forceps
Augenchirurgie Pinzetten
Ojo Pinzas Cirugía
Pince de chirurgie oculaire
Eye Pinze Chirurgia



37-903-01
Jameson Muscle Forcep
Right, With Slide Lock,
6 Teeth, Adult Size
Overall Length 10 cm (4")



37-903-02
Jameson Muscle Forcep
Left, With Slide Lock,
6 Teeth, Adult Size
Overall Length 10 cm (4")



37-905-20
Berke Ptosis Forcep
Longitudinally Grooved
Jaws, With Side Lock, 20 mm
Overall Length 11 cm (4 1/4")



37-905-27
Berke Ptosis Forcep
Longitudinally Grooved
Jaws, With Side Lock, 27 mm
Overall Length 11 cm (4 1/4")

Eye Surgery Forceps
Augenchirurgie Pinzetten
Ojo Pinzas Cirugia
Pince de chirurgie oculaire
Eye Pinze Chirurgia

37

FORCEPS

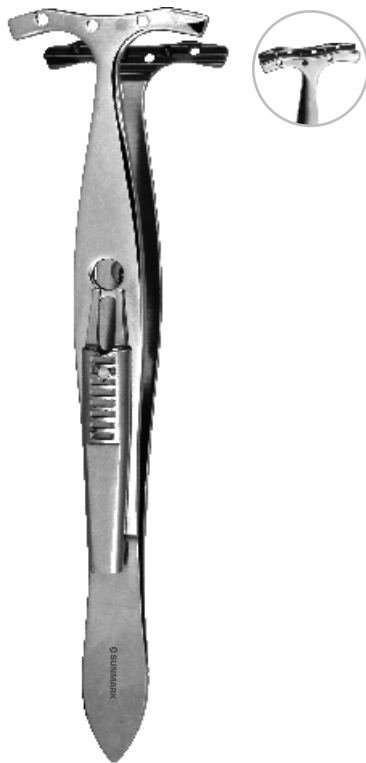

37-906-10
Putterman-Muellers Muscle Conjunctival Resection Ptosis Clamp
With Slide Lock
Overall Length 10 cm (4")



37-907-11
Watzke Sleeve Spreading Forcep
Jaw Length 10 mm
Overall Length 11.5 cm (4 1/2")



37-908-10
Erhardt Lid Forcep
Overall Length 10.5 cm (4")

Eye Surgery Forceps
Augenchirurgie Pinzetten
Ojo Pinzas Cirugía
Pince de chirurgie oculaire
Eye Pinze Chirurgia

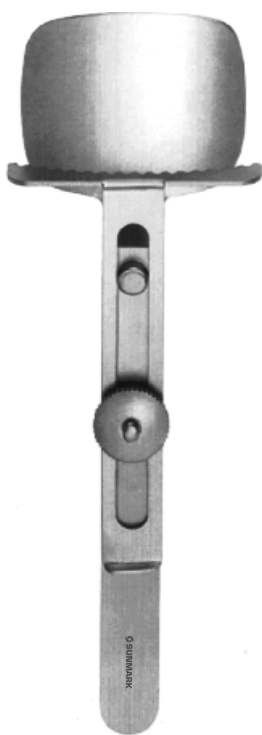

37-910-09
Downes Lid Clamp
Overall Length 9.5 cm (3 ¾")



37-912-08
Lambert Chalazion Forcep
Round Jaws, Ø 8.0 mm
Overall Length 9 cm (3 ½")



37-912-12
Hunt Chalazion Forcep
Round Jaws, Ø 12.0 mm
Overall Length 9.5 cm (3 ¾")



37-914-09
Baird Chalazion Forcep
Small, Oval Jaws, 11 x 8 mm
Overall Length 9.5 cm (3 ¾")

Ophthalmology Instruments
 Ophthalmologie Instrumente
 Oftalmologia Instrumentos
 Ophthalmologie Instruments
 Oftalmologia Strumenti

37

FORCEPS



37-916-09
Francis Chalazion Forcep
 Medium, Oval Jaws, 14 x 11 mm
 Overall Length 9.5 cm (3 3/4")



Desmarres Chalazion Forcep
 Overall Length 9 cm (3 1/2")
37-918-09
 Large, Oval Jaws, 20 x 13 mm

37-919-09
 Large, Oval Jaws, 25 x 13 mm



37-920-09
Wies Chalazion Forcep
 Grooved Upper Jaws
 Overall Length 9.5 cm (3 3/4")



37-921-09
Lordan Chalazion Forcep
 Triangular Jaws
 Overall Length 9.5 cm (3 3/4")

Eye Surgery Forceps
Augenchirurgie Pinzetten
Ojo Pinzas Cirugía
Pince de chirurgie oculaire
Eye Pinze Chirurgia



37-922-01
Ayer Chalazion Forcep
Round Jaws, Ø 12.0 mm
Overall Length 9.5 cm (3 ¾")



37-923-01
Desmarres Entropian Forcep
Right
Overall Length 10 cm (4")



37-923-02
Desmarres Entropian Forcep
Left
Overall Length 10 cm (4")



37-925-10
Collin Meibomian Gland
Expression Forcep
Ø 10 mm
Overall Length 10 cm (4")

Dissecting Forceps
Anatomische Pinzetten
Pinzas de disección
Pinces à dissection
Pinze per dissezione

FORCEPS



37-940-17
UltraGrip™ TC Bonney Dissecting Forcep
1 x 2 Teeth
Overall Length 17.5 cm (7")

ULTRA GRIP X



37-942-17
UltraGrip™ TC Gerald Dissecting Forcep
1 x 2 Teeth
Overall Length 17.5 cm (7")

ULTRA GRIP X



37-944-15
UltraGrip™ TC Gillies Dissecting Forcep
1 x 2 Teeth
Overall Length 15.5 cm (6")

ULTRA GRIP X



Dissecting Forceps
Anatomische Pinzetten
Pinzas de disección
Pincès à dissection
Pinze per dissezione



ULTRA GRIP[™]

37-946-15
UltraGrip™ TC McIndoe Dressing Forcep
Overall Length 15 cm (6")



37-950-16
16 cm (6 1/4")



37-950-18
18 cm (7")

ULTRA GRIP[™]

UltraGrip™ TC Semken Dissecting Forcep
1 x 2 Teeth



ULTRA GRIP[™]

UltraGrip™ TC Micro-Semken Dissecting Forcep
1 x 2 Teeth

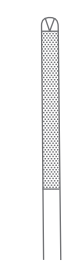

37-952-16
16 cm (6 1/4")

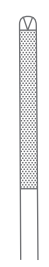

37-952-18
18 cm (7")



ULTRA GRIP[™]

37-956-12
UltraGrip™ TC Adson-Brown Dissecting Forcep
Overall Length 12 cm (4 3/4")

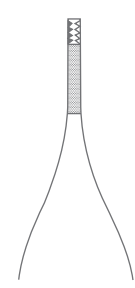

Dissecting Forceps
Anatomische Pinzetten
Pinzas de disección
Pincès à dissection
Pinze per dissezione

37

FORCEPS

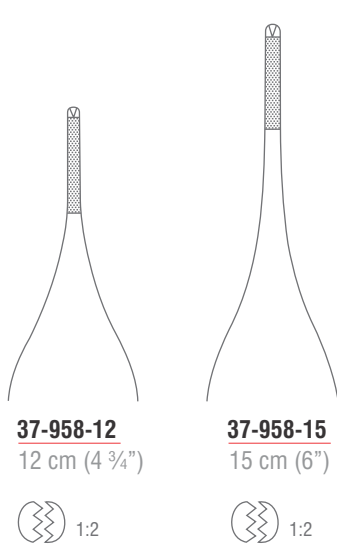

37-958-12
12 cm (4 3/4")

37-958-15
15 cm (6")



ULTRA GRIP[™]X

UltraGrip™ TC Micro-Adson Dissecting Forcep
1 x 2 Teeth

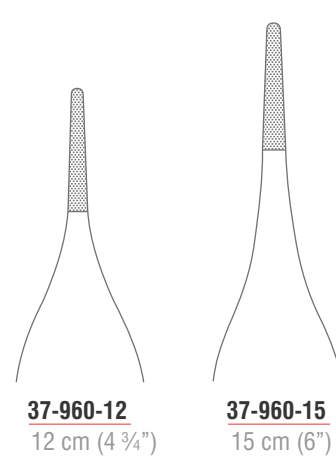

37-960-12
12 cm (4 3/4")

37-960-15
15 cm (6")

ULTRA GRIP[™]X

UltraGrip™ TC Adson Dressing Forcep

Dissecting Forceps
Anatomische Pinzetten
Pinzas de disección
Pinces à dissection
Pinze per dissezione



37-962-12
12 cm (4 ¾")



1:2

ULTRA GRIP X™

UltraGrip™ TC Adson Dissecting Forcep
1 x 2 Teeth



1:2

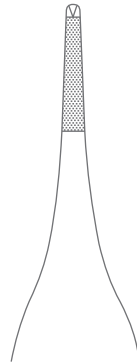
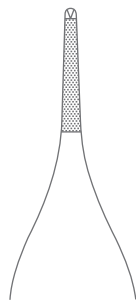

37-962-15
15 cm (6")



1:2



37-966-17
17.5 cm (7")

37-966-17
21 cm (8 ¼")

ULTRA GRIP X™

UltraGrip™ TC Cushing Dressing Forcep
Straight

Dissecting Forceps
Anatomische Pinzetten
Pinzas de disección
Pincers à dissection
Pinze per dissezione



ULTRA GRIP X

37-967-17
UltraGrip™ TC Cushing Dressing Forcep
Angled
Overall Length 17 cm (6 3/4")



ULTRA GRIP X

37-969-17
UltraGrip™ TC Cushing-Taylor Dressing Forcep
Bayonet Shaped
Overall Length 18.5 cm (7 1/4")



37-972-15
16 cm (6 1/4")

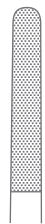

37-972-18
18.5 cm (7 1/4")



37-972-20
20 cm (8")



37-972-23
23 cm (9")



37-972-25
25 cm (9 3/4")

ULTRA GRIP X

UltraGrip™ TC Potts-Smith Dressing Forcep

Dissecting Forceps
 Anatomische Pinzetten
 Pinzas de disección
 Pinces à dissection
 Pinze per dissezione

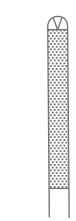

37-974-14
 14.5 cm (5 3/4")



37-974-16
 16 cm (6 1/4")

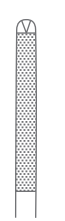

37-974-18
 18 cm (7")

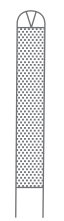

37-974-20
 20 cm (8")



37-974-25
 25 cm (9 3/4")



ULTRA GRIP[™]

UltraGrip™ TC Oehler Dissecting Forcep
 1 x 2 Teeth



37-978-17
UltraGrip™ TC Ferris-Smith Dissecting Forcep
 2 x 3 Teeth
 Overall Length 17.5 cm (7")

ULTRA GRIP[™]

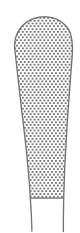

37-980-15
 15 cm (6")

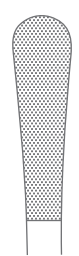

37-980-23
 23 cm (9")



ULTRA GRIP[™]

UltraGrip™ TC Wangenstein Dressing Forcep

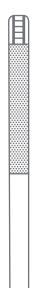

Dissecting Forceps
 Anatomische Pinzetten
 Pinzas de disección
 Pincers à dissection
 Pinze per dissezione

FORCEPS



		
37-990-16	37-990-20	37-990-24
1.6 mm	1.6 mm	1.6 mm
16 cm (6 ¼")	20 cm (8")	24.5 cm (9 ¾")

ULTRA GRIP

		
37-992-16	37-992-20	37-992-24
2.0 mm	2.0 mm	2.0 mm
16 cm (6 ¼")	20 cm (8")	24.5 cm (9 ¾")

ULTRA GRIP

UltraGrip™ TC Micro DeBakey Atraumatic Forceps

UltraGrip™ TC DeBakey Atraumatic Forceps

Dissecting Forceps
Anatomische Pinzetten
Pinzas de disección
Pincès à dissection
Pinze per dissezione



37-994-18
Straight



37-996-18
Straight
1 x 2 Teeth



37-997-18
UltraGrip™ TC Jaboma Forcep
1 x 2 Teeth, Angled
Overall Length 18 cm (7")

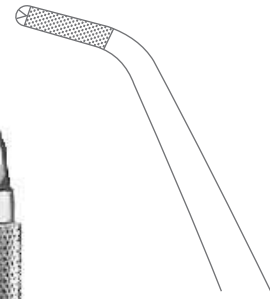

Clip Applying Forceps, Vessel Clips
 Clip-Anlegepinzette, Gefäßclips
 Pinzas para aplicar clips
 Pincers pour poser les clips vasculaires, Clips vasculaires
 Pinze per applicazione clips vascolari



23-010-14
Biemer Clamp Applying Forcep
 Without Lock
 Overall Length 14.5 cm (5 ¾")



23-012-14
Biemer Clamp Applying Forcep
 With Lock
 Overall Length 14.5 cm (5 ¾")



Biemer Vessel Clamp



23-016-14
 14 mm
 Opening : 4 mm
 Jaw Length : 4 mm
 Closing Pressure : 30 - 40 gr



23-018-17
 17 mm
 Opening : 7 mm
 Jaw Length : 5 mm
 Closing Pressure : 30 - 40 gr



23-020-17
 17 mm
 Opening : 7 mm
 Jaw Length : 5 mm
 Closing Pressure : 20 - 25 gr

Vessel Clips, Approximators
 Gefäßclips, Approximatoren
 Clips vasculares, Aproximadores
 Clips vasculaires, Approximateurs
 Clip vascolari, Approssimatori



23-024-17
Biemer-Mueller Approximator
 17 mm, Straight, Wide
 Opening : 5 mm
 Jaw Length : 9 mm
 Closing Pressure : 25 - 30 gr



23-025-17
Biemer-Mueller Approximator
 17 mm, Angled, Wide
 Opening : 5 mm
 Jaw Length : 9 mm
 Closing Pressure : 25 - 30 gr

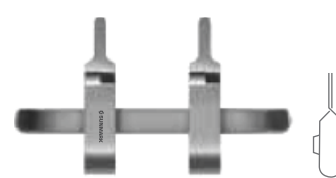

23-026-13
Biemer-Mueller Approximator
 13 mm, Straight, Narrow
 Opening : 3 mm
 Jaw Length : 4.5 mm
 Closing Pressure : 25 - 30 gr



23-026-17
Biemer-Mueller Approximator
 17 mm, Straight, Narrow
 Opening : 5 mm
 Jaw Length : 9 mm
 Closing Pressure : 25 - 30 gr



23-027-13
Biemer-Mueller Approximator
 13 mm, Angled, Narrow
 Opening : 3 mm
 Jaw Length : 4.5 mm
 Closing Pressure : 25 - 30 gr



23-027-17
Biemer-Mueller Approximator
 17 mm, Straight, Narrow
 Opening : 5 mm
 Jaw Length : 9 mm
 Closing Pressure : 25 - 30 gr



Mueller Approximator
 Overall Length 17 mm



23-030-01
 Ø 1.0 mm
 Closing Pressure
 25 - 30 gr



23-030-02
 Ø 2.0 mm
 Closing Pressure
 25 - 30 gr



23-030-03
 Ø 3.0 mm
 Closing Pressure
 25 - 30 gr

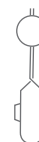

23-030-04
 Ø 4.0 mm
 Closing Pressure
 25 - 30 gr

Approximators
 Approximatoren
 Aproximadores
 Approximateurs
 Approssimatori

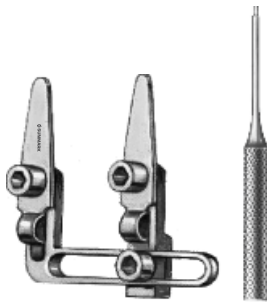

23-040-00
Nerve Approximator
 Complete with Key
 Standard



23-040-01
Key For Approximator



23-040-02
Nerve Approximator
 Approximator Only
 Standard

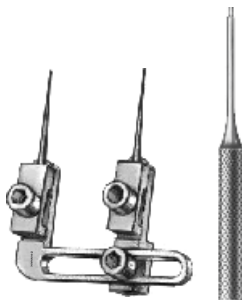

23-044-00
Nerve Approximator
 Complete with Key
 Needles Exchangeable by
 Mean of Key
 Standard

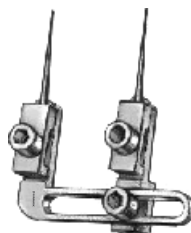

23-044-02
Nerve Approximator
 Approximator With Needles Only
 Standard



23-044-04
Spare Needle



Clip Applying Forceps, Vessel Clips
 Clip-Anlegezangen, Bulldogklemmen, Gefäßclips
 Pinzas para aplicar clips, Clips vasculares
 Pinces pour poser micro-clips, Clips vasculaires
 Pinze per applicare clips vascolari, Clip vascolari



23-046-14
Clip Applying Forcep
 With Ratchet
 Overall Length 14.5 cm (5 3/4")



23-049-18
Clip Applying Forcep
 Bayonet Shaped, With Ratchet
 Overall Length 18.5 cm (7 1/4")



23-050-04
 13 mm
 Jaw Size : 4.0 x 0.75 mm
 Closing Pressure : 60 gr

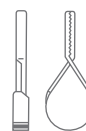

23-050-06
 15 mm
 Jaw Size : 6.0 x 1.0 mm
 Closing Pressure : 85 gr



Mini Vessel Clip

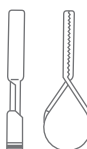

23-050-08
 17 mm
 Jaw Size : 8.0 x 2.0 mm
 Closing Pressure : 100 gr

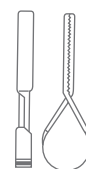

23-050-10
 20 mm
 Jaw Size : 10.0 x 2.0 mm
 Closing Pressure : 125 gr

Vessel Clips
 Gefäßclips
 Clips vasculares
 Clips vasculaires
 Clip vascolari

“A” or “V” Pattern?

The “V” pattern is the all-purpose clamp, used on almost all veins and arteries.

The “A” pattern, available in all sizes, is designed for thick-walled vessels and slippery arteries.

The slight curve at the tips of the “A” pattern jaws provide extra security against slippage.

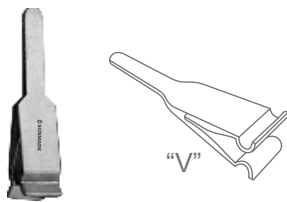

Acland Micro Vessel Clamp

For Vessels
 Single

23-052-08

Overall Length: 8 mm
 Vessel Size Ø 0.4 - 1.0 mm
 Clamping Force: 10 - 14 Gram

23-052-11

Overall Length: 11 mm
 Vessel Size Ø 0.6 - 1.5 mm
 Clamping Force: 17 - 23 Gram

23-052-14

Overall Length: 14 mm
 Vessel Size Ø 0.1 - 2.25 mm
 Clamping Force: 35 - 45 Gram

23-052-17

Overall Length: 17 mm
 Vessel Size Ø 1.5 - 3.5 mm
 Clamping Force: 60 - 75 Gram

23-052-25

Overall Length: 25 mm
 Vessel Size Ø 2.0 - 5.0 mm
 Clamping Force: 120 - 140Gram

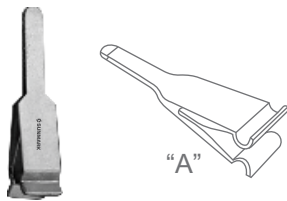

Acland Micro Vessel Clamp

For Vessels
 Single

23-053-08

Overall Length: 8 mm
 Vessel Size Ø 0.4 - 1.0 mm
 Clamping Force: 10 - 14 Gram

23-053-11

Overall Length: 11 mm
 Vessel Size Ø 0.6 - 1.5 mm
 Clamping Force: 17 - 23 Gram

23-053-14

Overall Length: 14 mm
 Vessel Size Ø 0.1 - 2.25 mm
 Clamping Force: 35 - 45 Gram

23-053-17

Overall Length: 17 mm
 Vessel Size Ø 1.5 - 3.5 mm
 Clamping Force: 60 - 75 Gram

23-053-25

Overall Length: 25 mm
 Vessel Size Ø 2.0 - 5.0 mm
 Clamping Force: 120 - 140 Gram

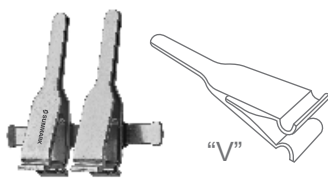

Acland Micro Vessel Clamp

For Vessels
 Double

23-054-08

Overall Length: 8 mm
 Vessel Size Ø 0.4 - 1.0 mm
 Clamping Force: 10 - 14 Gram

23-054-11

Overall Length: 11 mm
 Vessel Size Ø 0.6 - 1.5 mm
 Clamping Force: 17 - 23 Gram

23-054-14

Overall Length: 14 mm
 Vessel Size Ø 0.1 - 2.25 mm
 Clamping Force: 35 - 45 Gram

23-054-17

Overall Length: 17 mm
 Vessel Size Ø 1.5 - 3.5 mm
 Clamping Force: 60 - 75 Gram

23-054-25

Overall Length: 25 mm
 Vessel Size Ø 2.0 - 5.0 mm
 Clamping Force: 120 - 140Gram

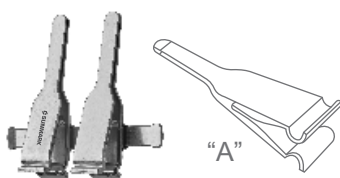

Acland Micro Vessel Clamp

For Vessels
 Double

23-055-08

Overall Length: 8 mm
 Vessel Size Ø 0.4 - 1.0 mm
 Clamping Force: 10 - 14 Gram

23-055-11

Overall Length: 11 mm
 Vessel Size Ø 0.6 - 1.5 mm
 Clamping Force: 17 - 23 Gram

23-055-14

Overall Length: 14 mm
 Vessel Size Ø 0.1 - 2.25 mm
 Clamping Force: 35 - 45 Gram

23-055-17

Overall Length: 17 mm
 Vessel Size Ø 1.5 - 3.5 mm
 Clamping Force: 60 - 75 Gram

23-055-25

Overall Length: 25 mm
 Vessel Size Ø 2.0 - 5.0 mm
 Clamping Force: 120 - 140 Gram

Vessel Clips
 Gefäßclips
 Clips vasculares
 Clips vasculaires
 Clip vascolari

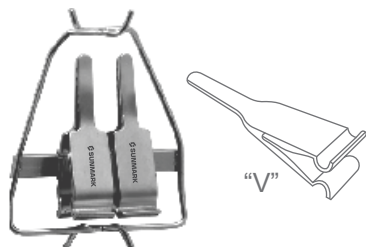

23-056-08

Overall Length: 8 mm
 Vessel Size Ø 0.4 - 1.0 mm
 Clamping Force: 10 - 14 Gram

23-056-11

Overall Length: 11 mm
 Vessel Size Ø 0.6 - 1.5 mm
 Clamping Force: 17 - 23 Gram

23-056-14

Overall Length: 14 mm
 Vessel Size Ø 0.1 - 2.25 mm
 Clamping Force: 35 - 45 Gram

Acland Micro Vessel Clamp

For Vessels
 Double, With Frame

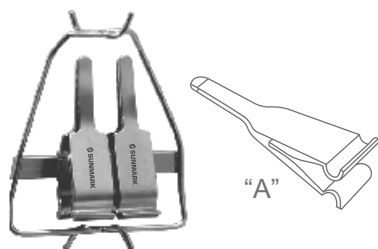

23-057-08

Overall Length: 8 mm
 Vessel Size Ø 0.4 - 1.0 mm
 Clamping Force: 10 - 14 Gram

23-057-11

Overall Length: 11 mm
 Vessel Size Ø 0.6 - 1.5 mm
 Clamping Force: 17 - 23 Gram

23-057-14

Overall Length: 14 mm
 Vessel Size Ø 0.1 - 2.25 mm
 Clamping Force: 35 - 45 Gram

Acland Micro Vessel Clamp

For Vessels
 Double, With Frame



23-058-00

Acland Clamp Applying Forcep

Overall Length 14.5 cm (5 3/4")



Bulldog Clamps
 Bulldogklemmen
 Clamps Bulldog
 Clamps Bulldog
 Pinze Bulldog

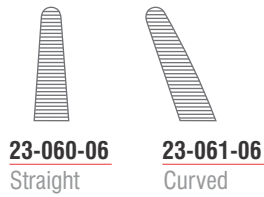

Dieffenbach Bulldog Clamp
 Overall Length 6 cm (2 1/4")

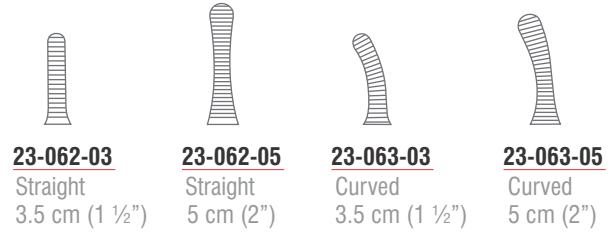

Dieffenbach Bulldog Clamp



John-Hopkins Bulldog Clamp

Codes	Overall Length	Jaw Length
23-065-35	3.5 cm (1 1/2")	12 mm
23-065-50	5 cm (2")	17 mm
23-065-55	5.5 cm (2 1/8")	25 mm
23-065-65	6.5 cm (2 1/2")	30 mm
23-065-70	7 cm (2 3/4")	33 mm
23-065-80	8 cm (3 1/4")	42 mm
23-065-90	9 cm (3 1/2")	52 mm





23-067-24
John-Hopkins Clamp Applying Forcep
 Overall Length 24 cm (9 1/2")

Bulldog Clamps
 Bulldogklemmen
 Clamps Bulldog
 Clamps Bulldog
 Pinze Bulldog



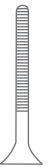

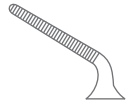
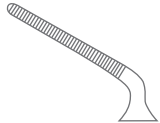
Diethrich Bulldog Clamp

					
23-080-45 Straight 45 mm, 8 mm	23-080-50 Straight 50 mm, 12 mm	23-080-60 Straight 60 mm, 20 mm	23-081-40 Angled 45 mm, 8 mm	23-081-45 Angled 50 mm, 12 mm	23-081-50 Angled 60 mm, 20 mm

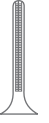
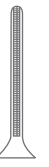
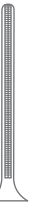

DeBakey-Diethrich Atrauma Bulldog Clamp

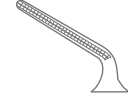
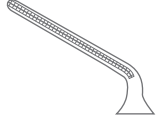
					
23-084-10 Straight 45 mm, 10 mm	23-084-14 Straight 50 mm, 14 mm	23-084-20 Straight 60 mm, 20 mm	23-085-10 Angled 35 mm, 10 mm	23-085-14 Angled 45 mm, 14 mm	23-085-20 Angled 50 mm, 20 mm

Bulldog Clamps
 Bulldogklemmen
 Clamps Bulldog
 Clamps Bulldog
 Pinze Bulldog

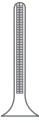
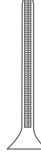
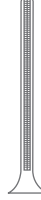
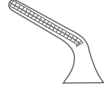
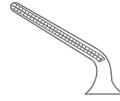
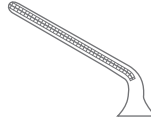

					
23-084-10 T Straight 45 mm, 10 mm	23-084-14 T Straight 50 mm, 14 mm	23-084-20 T Straight 60 mm, 20 mm	23-085-10 T Angled 35 mm, 10 mm	23-085-14 T Angled 45 mm, 14 mm	23-085-20 T Angled 50 mm, 20 mm

DeBakey-Diethrich Atrauma Bulldog Clamp
 Titanium

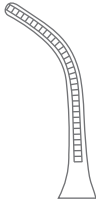

	
23-087-10 35 mm, 10 mm	23-087-20 50 mm, 10 mm

DeBakey-Diethrich Atrauma Bulldog Clamp
 Curved



23-089-35 35 mm, 10 mm	23-089-40 40 mm, 10 mm
----------------------------------	----------------------------------

DeBakey-Hess Bulldog Clamp



Bulldog Clamps
Bulldogklemmen
Clamps Bulldog
Clamps Bulldog
Pinze Bulldog



Mini-Glover Vena Atrauma Bulldog Clamp
Titanium



			
23-090-30 T Straight 30 mm, 9 mm	23-090-35 T Straight 35 mm, 13 mm	23-090-40 T Straight 40 mm, 14 mm	23-090-50 T Straight 50 mm, 23 mm
			
23-091-30 T Gently Curved 30 mm, 9 mm	23-091-35 T Gently Curved 35 mm, 13 mm	23-091-40 T Gently Curved 40 mm, 14 mm	23-091-50 T Gently Curved 50 mm, 23 mm
			
23-093-30 T Strongly Curved 30 mm, 9 mm	23-093-35 T Strongly Curved 35 mm, 13 mm	23-093-40 T Strongly Curved 40 mm, 14 mm	23-093-50 T Strongly Curved 50 mm, 23 mm

Bulldog Clamps
 Bulldogklemmen
 Clamps Bulldog
 Clamps Bulldog
 Pinze Bulldog



Mini-Glover Arteria Atrauma Bulldog Clamp
 Titanium



23-096-30 T
 Straight
 30 mm, 9 mm



23-096-35 T
 Straight
 35 mm, 13 mm



23-096-40 T
 Straight
 40 mm, 14 mm



23-096-50 T
 Straight
 50 mm, 23 mm



23-097-30 T
 Gently Curved
 30 mm, 9 mm



23-097-35 T
 Gently Curved
 35 mm, 13 mm



23-097-40 T
 Gently Curved
 40 mm, 14 mm



23-097-50 T
 Gently Curved
 50 mm, 22 mm



23-099-30 T
 Strongly Curved
 30 mm, 9 mm



23-099-35 T
 Strongly Curved
 35 mm, 14 mm



23-099-40 T
 Strongly Curved
 40 mm, 15 mm



23-099-50 T
 Strongly Curved
 50 mm, 21 mm

Haemostatic Forceps
 Arterienklemmen
 Pinzas hemostáticas
 Pincès hémostatiques
 Pinze emostatiche



Pean Haemostatic Forcep



23-110-14
 Straight
 14.5 cm (5 3/4")



23-110-16
 Straight
 16 cm (6 1/4")

23-111-14
 Curved
 14.5 cm (5 3/4")

23-111-16
 Curved
 16 cm (6 1/4")









23-112-13
Korenlein Haemostatic Forcep
 Overall Length 13 cm (5")



Haemostatic Forceps
 Arterienklemmen
 Pinzas hemostáticas
 Pinces hémostatiques
 Pinze emostatiche

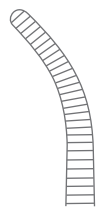

Spencer-Wells Haemostatic Forcep

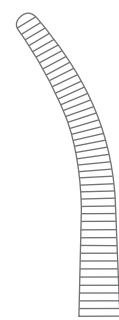
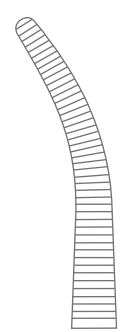
- | | | | | |
|--|--|---|--|--|
|  |  |  |  |  |
| 23-114-13
13 cm (5") | 23-114-14
14.5 cm (5 ¾") | 23-114-15
15.5 cm (6") | 23-114-18
18.5 cm (7 ¼") | 23-114-20
20 cm (8") |
|  |  |  |  |  |
| 23-115-13
13 cm (5") | 23-115-14
14 cm (5 ½") | 23-115-15
15 cm (6") | 23-115-18
18 cm (7") | 23-115-20
20 cm (8") |



23-120-13
Chaput Haemostatic Forcep
 2 x 3 Teeth
 Overall Length 12.5 cm (5")



23-122-13
Tuffier Haemostatic Forcep
 4 x 5 Teeth
 Overall Length 12.5 cm (5")



Haemostatic Forceps, Organ Grasping Forceps
Arterienklemmen, Organfasszangen
Pinzas hemostáticas, Pinzas para sacar órganos
Pinces hémostatiques, Pinces pour saisir organes
Pinze emostatiche, Pinze per afferrare organi



Atrauma Organ Grasping / Haemorrhoidal Forcep



23-126-25
25 cm (9 3/4")



23-126-26
26 cm (10 1/4")



23-128-14
Collin Organ Grasping Forcep
Overall Length 14 cm (5 1/2")



23-130-17
Collin Tumor Grasping Forcep
Overall Length 17 cm (6 3/4")



Pennington Organ Grasping Forcep

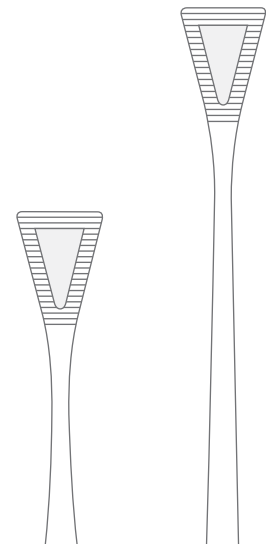

23-134-15
15.5 cm (6")

23-134-20
21 cm (8 1/4")

Haemostatic Forceps
Arterienklemmen
Pinzas hemostáticas
Pinces hémostatiques
Pinze emostatiche



23-136-15
Pratt Haemostatic Forcep
Overall Length 15 cm (6")



23-138-14
Martel-Rees Facelift Forcep
Overall Length 13.5 cm (5 1/4")



Hartmann Haemostatic Forcep



23-140-10
Straight
10 cm (4")



23-141-10
Curved
9.5 cm (3 3/4")



23-142-10
Straight
1 x 2 Teeth
10 cm (4")



23-143-10
Curved
1 x 2 Teeth
9.5 cm (3 3/4")

Haemostatic Forceps
Arterienklemmen
Pinzas hemostáticas
Pinces hémostatiques
Pinze emostatiche



23-146-12
Haemostatic Forcep
Cross Serrated Jaw
Overall Length 12.5 cm (5")



23-148-08
Carrel Haemostatic Forcep
Overall Length 8.5 cm (3 1/4")



23-150-08
Terrier Haemostatic Forcep
1 x 2 Teeth
Overall Length 8.5 cm (3 1/4")



Haemostatic Forceps
 Arterienklemmen
 Pinzas hemostáticas
 Pincès hémostatiques
 Pinze emostatiche



Halsted-Mosquito Haemostatic Forcep



23-160-12
 Straight
 12.5 cm (4 ¾")



23-160-14
 Straight
 14.5 cm (5 ½")



23-161-12
 Curved
 12 cm (4 ¾")



23-161-14
 Curved
 14 cm (5 ½")



23-162-12
 Straight
 1 x 2 Teeth
 12.5 cm (4 ¾")



23-162-14
 Straight
 1 x 2 Teeth
 14.5 cm (5 ½")



23-163-12
 Curved
 1 x 2 Teeth
 12 cm (4 ¾")



23-163-14
 Curved
 1 x 2 Teeth
 14 cm (5 ½")



Micro-Mosquito Haemostatic Forcep



23-170-10
 Straight
 10 cm (4")



23-170-12
 Straight
 12 cm (4 ¾")



23-171-10
 Curved
 9.5 cm (3 ¾")



23-171-12
 Curved
 11.5 cm (4 ½")



23-172-10
 Straight
 1 x 2 Teeth
 10 cm (4")



23-172-12
 Straight
 1 x 2 Teeth
 12 cm (4 ¾")



23-173-10
 Curved
 1 x 2 Teeth
 10 cm (4")



23-173-12
 Curved
 1 x 2 Teeth
 12 cm (4 ¾")



Haemostatic Forceps
 Arterienklemmen
 Pinzas hemostáticas
 Pinces hémostatiques
 Pinze emostatiche



Halsted-Mosquito Haemostatic Forcep



23-176-18
 Straight
 18.5 cm (7 1/4")



23-176-21
 Straight
 21 cm (8 1/4")



23-177-18
 Curved
 18 cm (7")



23-177-21
 Curved
 20.5 cm (8")



23-178-18
 Straight
 1 x 2 Teeth
 18.5 cm (7 1/4")



23-178-21
 Straight
 1 x 2 Teeth
 21 cm (8 1/4")



23-179-18
 Curved
 1 x 2 Teeth
 18 cm (7")



23-179-21
 Curved
 1 x 2 Teeth
 21 cm (8")



Providence-Hospital Haemostatic Forcep



23-182-14
 Straight
 14 cm (5 1/2")



23-183-14
 Curved
 14 cm (5 1/2")

Haemostatic Forceps
Arterienklemmen
Pinzas hemostáticas
Pinces hémostatiques
Pinze emostatiche



Leriche Haemostatic Forcep



23-184-15
Straight
15.5 cm (6")



23-185-15
Curved
15 cm (6")



23-186-15
Straight
1 x 2 Teeth
15.5 cm (6")

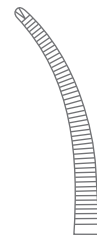

23-187-15
Curved
1 x 2 Teeth
15 cm (6")



Kelly Haemostatic Forcep



23-200-14
14.5 cm (5 3/4")



23-201-14
14.5 cm (5 3/4")

Haemostatic Forceps
Arterienklemmen
Pinzas hemostáticas
Pinces hémostatiques
Pinze emostatiche



23-202-16
Straight
16 cm (6 1/4")

23-203-16
Curved
15.5 cm (6")

Kelly-Rankin Haemostatic Forcep



23-210-14
Straight
14.5 cm (5 3/4")

23-211-14
Curved
14 cm (5 1/2")

23-212-14
Straight
1 x 2 Teeth
14.5 cm (5 3/4")

23-213-14
Curved
1 x 2 Teeth
14 cm (5 1/2")

Crile Haemostatic Forcep



Haemostatic Forceps
Arterienklemmen
Pinzas hemostáticas
Pincès hémostatiques
Pinze emostatiche



Crile-Rankin Haemostatic Forcep
Overall Length 17 cm (6 ¾")

Haemostatic Forceps
Arterienklemmen
Pinzas hemostáticas
Pinces hémostatiques
Pinze emostatiche

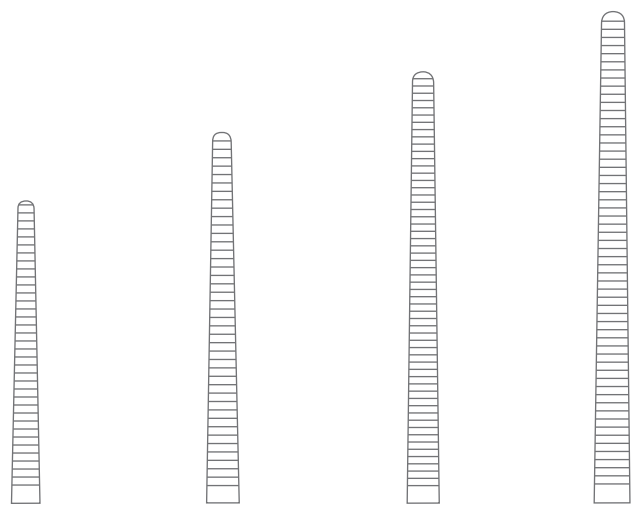

23-220-14
14.5 cm (5 3/4")

23-220-16
16.5 cm (6 1/2")

23-220-18
18.5 cm (7 1/4")

23-220-20
20.5 cm (8")



Rochester-Pean Haemostatic Forcep
Straight

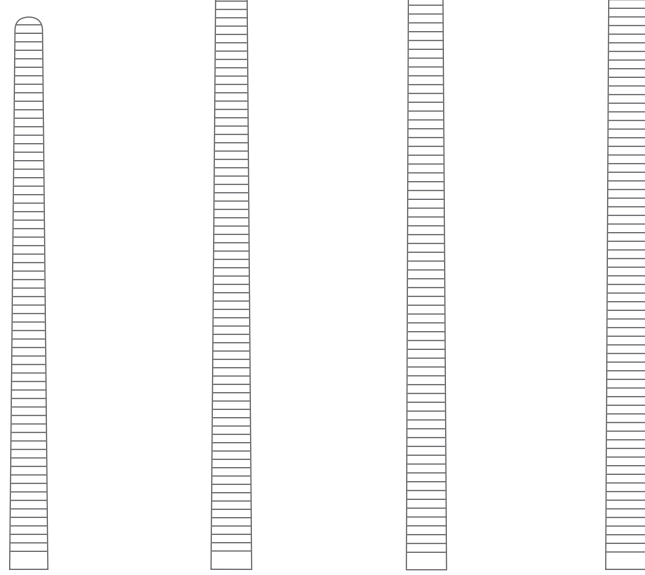

23-220-22
22.5 cm (8 3/4")

23-220-24
24.5 cm (9 3/4")

23-220-26
26 cm (10 1/4")

23-220-30
30.5 cm (12")

Haemostatic Forceps
 Arterienklemmen
 Pinzas hemostáticas
 Pinces hémostatiques
 Pinze emostatiche

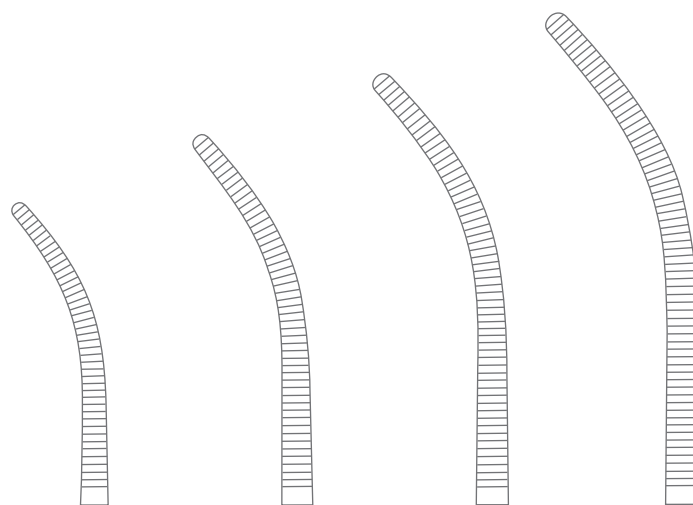

23-221-14
 14 cm (5 1/2")

23-221-16
 16 cm (6 1/4")

23-221-18
 18 cm (7")

23-221-20
 20 cm (8")



Rochester-Pean Haemostatic Forcep
 Curved

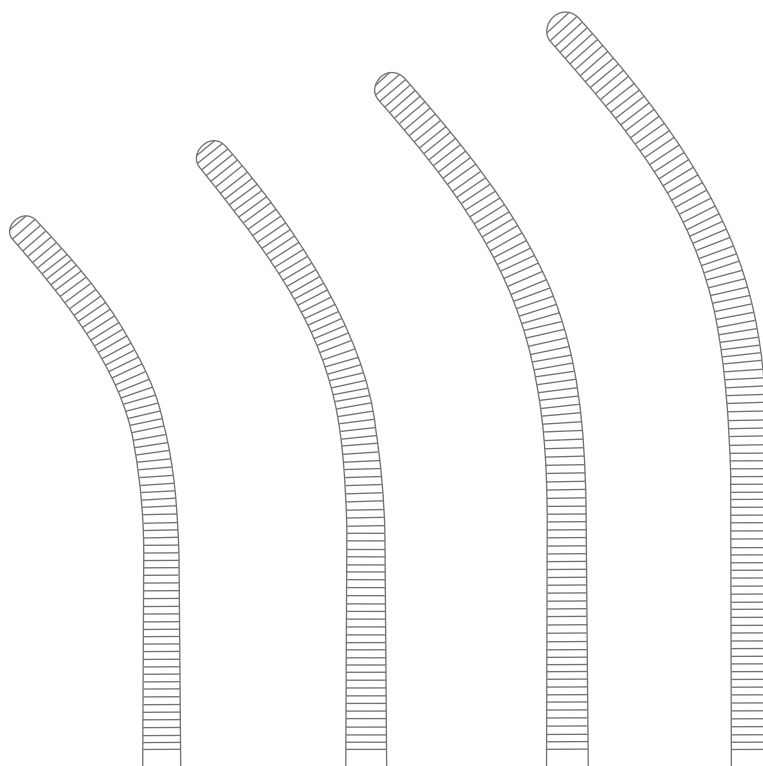

23-221-22
 22 cm (8 3/4")

23-221-24
 24 cm (9 1/2")

23-221-26
 25.5 cm (10")

23-221-30
 30 cm (11 3/4")

Haemostatic Forceps
 Arterienklemmen
 Pinzas hemostáticas
 Pinces hémostatiques
 Pinze emostatiche



23-230-14
 14.5 cm (5 3/4")



23-230-16
 16.5 cm (6 1/2")



23-230-18
 18.5 cm (7 1/4")



23-230-20
 20.5 cm (8")



Ochsner-Kocher Haemostatic Forcep
 Straight, 1 x 2 Teeth



23-230-22
 22.5 cm (8 3/4")

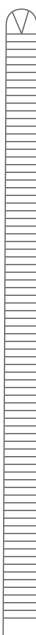

23-230-24
 24.5 cm (9 3/4")



23-230-26
 26 cm (10 1/4")

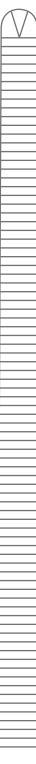

23-230-30
 30.5 cm (12")

Haemostatic Forceps
Arterienklemmen
Pinzas hemostáticas
Pincès hémostatiques
Pinze emostatiche

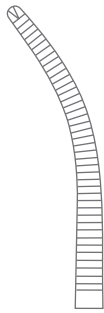

23-231-14
14 cm (5 1/2")

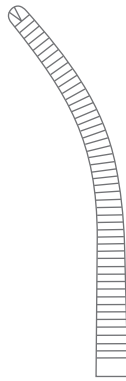

23-231-16
16 cm (6 1/4")

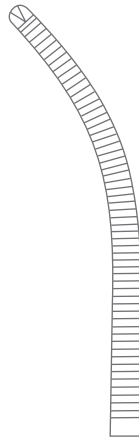

23-231-18
18 cm (7")

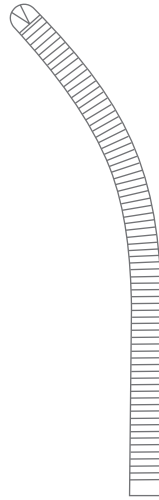

23-231-20
20 cm (8")

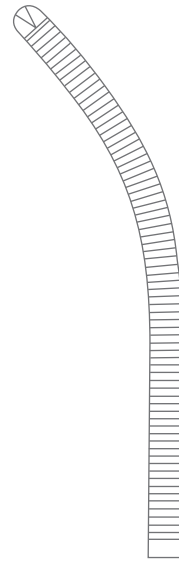

23-231-22
22 cm (8 3/4")

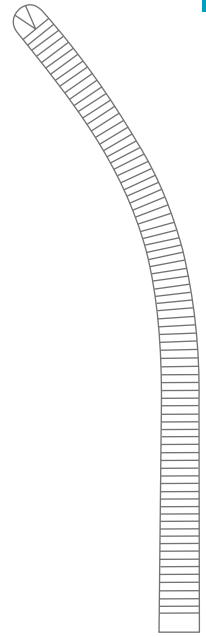

23-231-24
24 cm (9 1/2")



Ochsner-Kocher Haemostatic Forcep
Curved, 1 x 2 Teeth

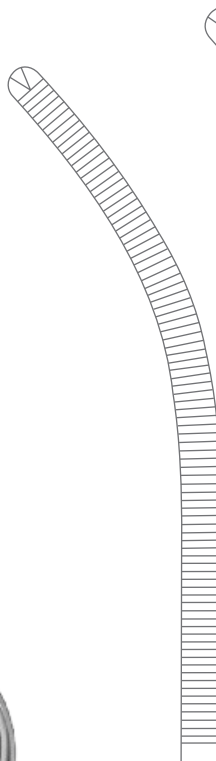

23-231-26
25.5 cm (10")

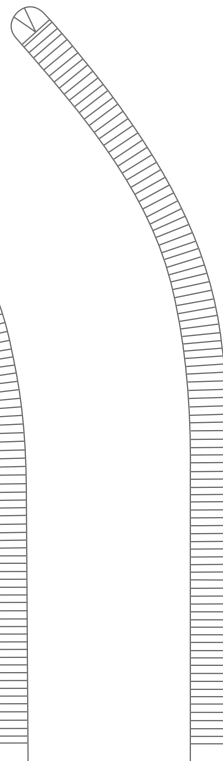

23-231-30
30 cm (11 3/4")



1:2



Haemostatic Forceps
Arterienklemmen
Pinzas hemostáticas
Pinces hémostatiques
Pinze emostatiche



23-234-14
Straight

23-235-14
Curved

Rochester-Ochsner Haemostatic Forcep
1 x 2 Teeth
Overall Length 14 cm (5 1/2")



23-236-15
Straight

23-237-15
Curved

Kocher Haemostatic Forcep
1 x 2 Teeth
Overall Length 15 cm (6")



Haemostatic Forceps
Arterienklemmen
Pinzas hemostáticas
Pinces hémostatiques
Pinze emostatiche



Pean-Nippon Haemostatic Forcep



23-240-14
Straight
14.5 cm (5 ¾")



23-240-16
Straight
16.5 cm (6 ½")



23-240-18
Straight
18.5 cm (7 ¼")



23-241-14
Curved
14 cm (5 ½")



23-241-16
Curved
16 cm (6 ¼")



23-241-18
Curved
18 cm (7")

Haemostatic Forceps
Arterienklemmen
Pinzas hemostáticas
Pinces hémostatiques
Pinze emostatiche



Kocher-Nippon Haemostatic Forcep
1 x 2 Teeth



23-242-14
Straight
14.5 cm (5 3/4")



23-242-16
Straight
16.5 cm (6 1/2")



23-242-18
Straight
18.5 cm (7 1/4")



23-243-14
Curved
14.5 cm (5 3/4")



23-243-16
Curved
16 cm (6 1/4")



23-243-18
Curved
18 cm (7")

Haemostatic Forceps
Arterienklemmen
Pinzas hemostáticas
Pinces hémostatiques
Pinze emostatiche



Pean (Delicate) Haemostatic Forcep



23-246-13
Straight
13.5 cm (5 3/4")



23-246-14
Straight
14.5 cm (5 3/4")



23-246-17
Straight
17 cm (6 3/4")



23-247-13
Curved
13 cm (5")



23-247-14
Curved
14 cm (5 1/2")



23-247-16
Curved
16.5 cm (6 1/2")

Haemostatic Forceps
Arterienklemmen
Pinzas hemostáticas
Pinces hémostatiques
Pinze emostatiche



Kocher (Delicate) Haemostatic Forcep
1 x 2 Teeth



23-248-13
Straight
13 cm (5")



23-248-14
Straight
14 cm (5 1/2")



23-248-17
Straight
16 cm (6 1/4")

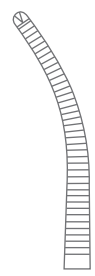

23-249-13
Curved
13 cm (5")

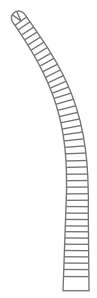

23-249-14
Curved
14 cm (5 1/2")



23-249-16
Curved
16 cm (6 1/4")

Haemostatic Forceps
Arterienklemmen
Pinzas hemostáticas
Pinces hémostatiques
Pinze emostatiche



Coller Haemostatic Forcep



23-260-14
Straight
14 cm (5 1/2")



23-260-16
Straight
16.5 cm (6 1/2")



23-260-18
Straight
18.5 cm (7 1/4")



23-261-14
Curved
14 cm (5 1/2")



23-261-16
Curved
16.5 cm (6 1/2")

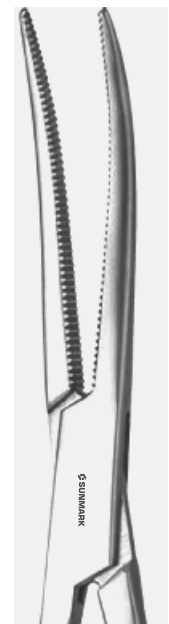

23-261-18
Curved
18.5 cm (7 1/4")

Haemostatic Forceps
Arterienklemmen
Pinzas hemostáticas
Pinces hémostatiques
Pinze emostatiche



23-265-18
Fraser-Kelly (Crile) Haemostatic Forcep
Curved
Overall Length 18 cm (7")



23-268-18
Straight
19 cm (7 1/2")

23-269-18
Curved
18.5 cm (7 1/4")

Adson Haemostatic Forcep

Haemostatic Forceps
Arterienklemmen
Pinzas hemostáticas
Pincès hémostatiques
Pinze emostatiche



23-271-21
Adson Haemostatic Forcep
Curved
Overall Length 21.5 cm (8 ½")



23-275-19
Jacobson Haemostatic Forcep
Curved
Overall Length 19 cm (7 ½")

Haemostatic Forceps
Arterienklemmen
Pinzas hemostáticas
Pinces hémostatiques
Pinze emostatiche



23-277-19
Dunhill Haemostatic Forcep
Straight
Overall Length 19 cm (7 1/2")



23-279-19
Grey-Turner Haemostatic Forcep
Curved
Overall Length 18 cm (7")

Haemostatic Forceps
Arterienklemmen
Pinzas hemostáticas
Pincas hémostatiques
Pinze emostatiche



23-281-12
Dandy-Mosquito Haemostatic Forcep
Laterally Curved, Cross Serrated
Overall Length 12 cm (4 ¾")



23-283-14
Laterally Curved

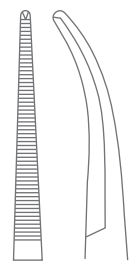

23-285-14
Laterally Curved
1 x 2 Teeth

Dandy Haemostatic Forcep
Overall Length 14.5 cm (5 ¾")

Haemostatic Forceps
Arterienklemmen
Pinzas hemostáticas
Pincas hémostatiques
Pinze emostatiche



23-290-15
Straight



23-291-15
Curved

Cairns Haemostatic Forcep
Overall Length 15 cm (6")



23-293-14
Cairns Haemostatic Forcep
Curved to Side
Overall Length 14.5 cm (5 3/4")



23-295-15
Moynihan Haemostatic Forcep
Curved
Overall Length 15 cm (6")

Haemostatic Forceps
Arterienklemmen
Pinzas hemostáticas
Pincès hémostatiques
Pinze emostatiche



23-296-13
Straight

23-297-13
Curved

Dunhill Haemostatic Forcep
Overall Length 12.5 cm (5")



23-300-16

23-302-16
1 x 2 Teeth



Lovelace Haemostatic Forcep
Straight, Cross Serrated
Overall Length 16 cm (6 1/4")

Haemostatic Forceps
Arterienklemmen
Pinzas hemostáticas
Pinces hémostatiques
Pinze emostatiche



23-305-20
Martin-Fuchsig Haemostatic Forcep
Curved
Overall Length 20.5 cm (8")



23-307-18
18.5 cm (7 1/4")

23-307-23
23 cm (9")

Nissen Haemostatic Forcep
Curved

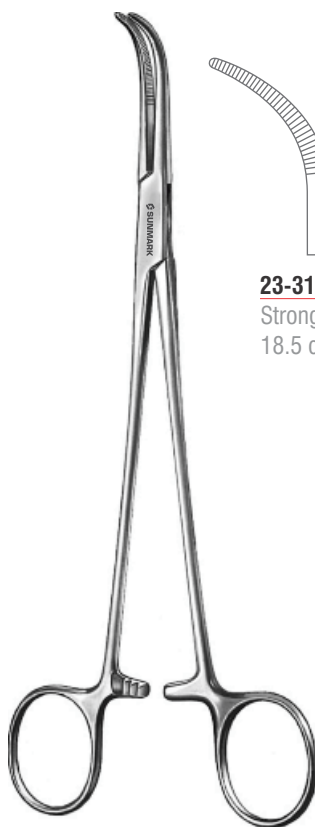

Schnidt Tonsil Haemostatic Forcep

23-311-01
Strongly Curved
18.5 cm (7 1/4")

23-311-02
Gently Curved
19 cm (7 1/2")

Operating Scissors
Chirurgische Scheren
Tijeras quirúrgicas
Ciseaux chirurgicaux
Forbici per chirurgia



Negus Haemostatic Forcep

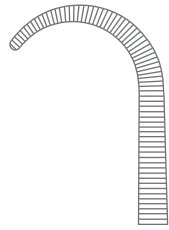

23-315-01
Fig. 1
19.5 cm (7 3/4")



23-315-02
Fig. 2
20 cm (8")

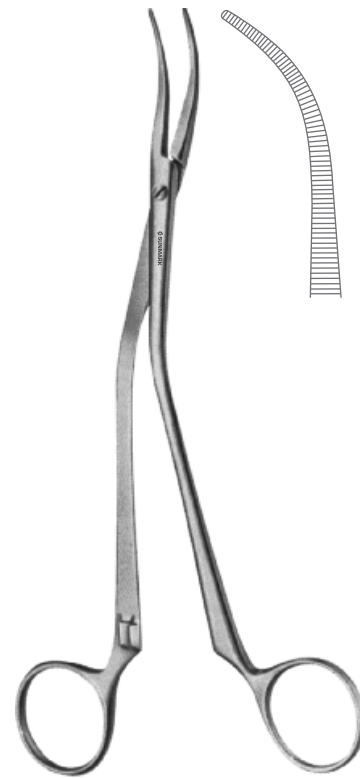

23-317-19
Wilson Haemostatic Forcep
Curved
Overall Length 19 cm (7 1/2")



Rochester-Carmalt Haemostatic Forcep

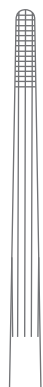

23-320-16
17 cm (6 3/4")



23-320-20
20.5 cm (8")



23-321-16
16.5 cm (6 1/2")



23-321-20
20 cm (8")

Haemostatic Forceps
Arterienklemmen
Pinzas hemostáticas
Pinces hémostatiques
Pinze emostatiche

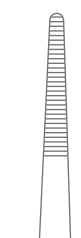

23-331-18



23-333-18
1 x 2 Teeth

Fickling Haemostatic Forcep
Overall Length 18 cm (7")

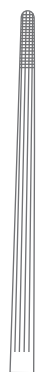

23-340-15
Straight
15 cm (6")



23-340-18
Straight
18.5 cm (7 1/4")

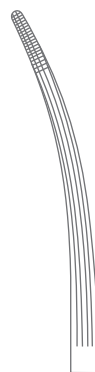

23-341-15
Curved
15 cm (6")



23-341-18
Curved
18.5 cm (7 1/4")

Bainbridge Haemostatic Forcep
Longitudinally Serrated



Haemostatic Forceps
Arterienklemmen
Pinzas hemostáticas
Pincés hémostatiques
Pinze emostatiche



Collier-Anderson Haemostatic Forcep
Curved

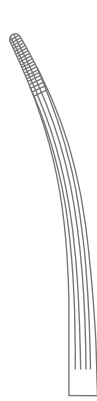

23-343-25
25.5 cm (10")

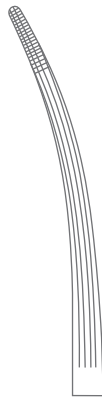

23-343-28
28 cm (11")



Birkett Haemostatic Forcep
Overall Length 18.5 cm (7 1/4")



23-346-18
Straight

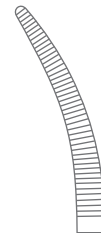

23-347-18
Curved

Haemostatic Forceps
Arterienklemmen
Pinzas hemostáticas
Pinces hémostatiques
Pinze emostatiche



Bengolea Haemostatic Forcep



23-350-20
Straight
21.5 cm (8 1/2")



23-350-26
Straight
26 cm (10 1/4")



23-351-20
Curved
21 cm (8 1/4")



23-351-26
Curved
25.5 cm (10 ")



23-352-20
Straight
1 x 2 Teeth
21.5 cm (8 1/2")



23-352-26
Straight
1 x 2 Teeth
26 cm (10 1/4")

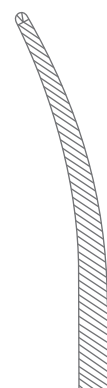

23-353-20
Curved
1 x 2 Teeth
21 cm (8 1/4")

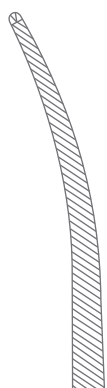

23-353-26
Curved
1 x 2 Teeth
25.5 cm (10 ")

Operating Scissors
 Chirurgische Scheren
 Tijeras quirúrgicas
 Ciseaux chirurgicaux
 Forbici per chirurgia



Roberts Haemostatic Forcep



23-360-22
 Straight
 22.5 cm (8 ¾")

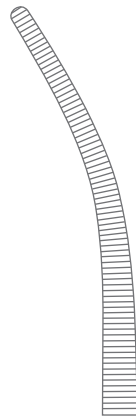

23-361-22
 Curved
 21.5 cm (8 ½")



Sarot Haemostatic Forcep



23-364-24
 Straight
 25 cm (9 ¾")

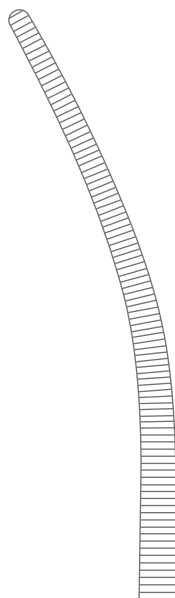

23-365-24
 Curved
 24.5 cm (9 ¾")

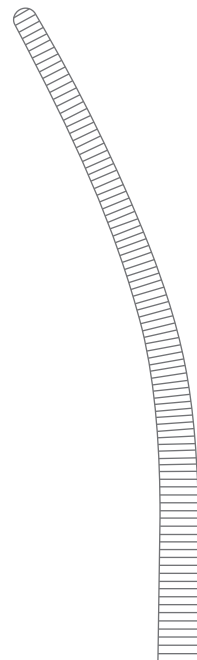

23-365-28
 Curved
 28 cm (11")

Haemostatic Forceps
Arterienklemmen
Pinzas hemostáticas
Pinces hémostatiques
Pinze emostatiche



23-371-18
18 cm (7")

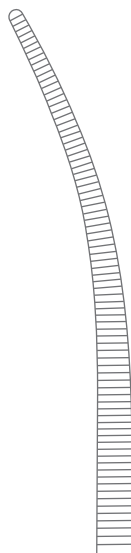

23-371-24
24.5 cm (9 3/4")

Crafoord Haemostatic Forcep
Curved



23-375-01
Fig. 1

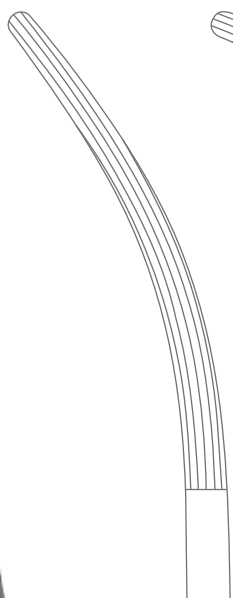

23-375-02
Fig. 2

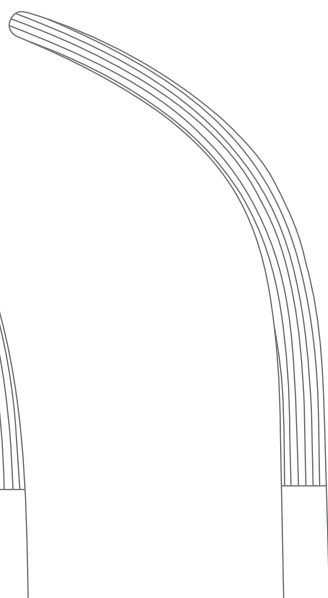

23-375-03
Fig. 3

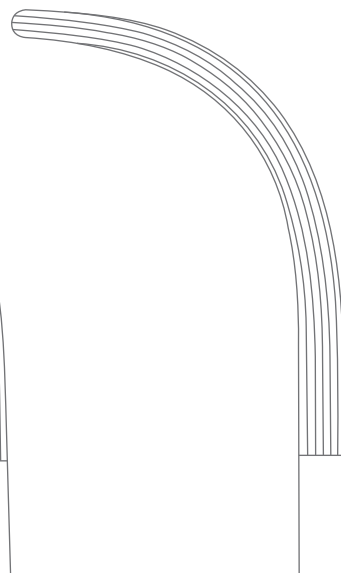

Crafoord-Sellors Haemostatic Forcep
Overall Length 24 cm (9 1/2")



Haemostatic Forceps
Arterienklemmen
Pinzas hemostáticas
Pincès hémostatiques
Pinze emostatiche



Bridge Haemostatic Forcep
Overall Length 27.5 cm (10 ¾")



23-380-27
Straight

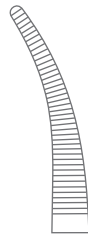

23-381-27
Curved



Heiss Haemostatic Forcep



23-386-20
21 cm (8 ¼")

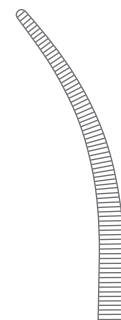

23-387-20
20.5 cm (8")

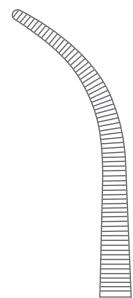

23-389-20
20 cm (8")

Haemostatic Forceps, Dissecting and Ligature Forceps
 Arterienklemmen, Präparierklemmen
 Pinzas hemostáticas, Pinzas para preparación y ligadura
 Pinces hémostatiques, Pinces à disséquer et à ligatures
 Pinze emostatiche, Pinze per preparazioni e legature



23-390-20
 Straight
 1 x 2 Teeth



23-391-20
 Curved
 1 x 2 Teeth

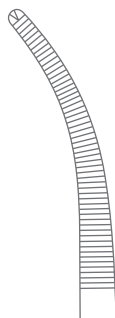

Heiss Haemostatic Forcep
 Overall Length 20 cm (8")



23-401-01
 Fig. 1
 18.5 cm (7 ¼")

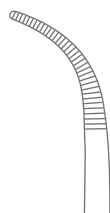

23-401-02
 Fig. 2
 20.5 cm (8")

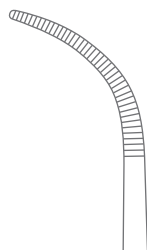

23-401-03
 Fig. 3
 21 cm (8 ¼")



23-401-04
 Fig. 4
 21.5 cm (8 ½")

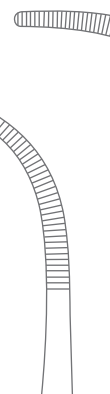

23-401-05
 Fig. 5
 24.5 cm (9 ¾")

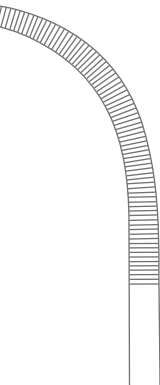

Overholt-Martin Dissecting and Ligature Forcep

Dissecting and Ligature Forceps
 Präparierklemmen
 Pinzas para preparación y ligadura
 Pincès à disséquer et à ligatures
 Pinze per preparazioni e legature



23-404-12
Dissecting and Ligature Forcep
 Smooth Jaws
 Overall Length 12.5 cm (5")



23-405-14
Guys Galabin Suture Forcep
 Angled to Side, Smooth Jaws
 Overall Length 14 cm (5 ½")



23-407-14
Parotid Spreading Forcep
 Fine Curved
 Overall Length 14 cm (5 ½")

Dissecting and Ligature Forceps
 Präparierklemmen
 Pinzas para preparación y ligadura
 Pinces à disséquer et à ligatures
 Pinze per preparazioni e legature



23-411-14
14.5 cm (5 ¾")

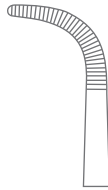

23-411-18
18 cm (7")

Adson-Baby Dissecting and Ligature Forcep
Curved

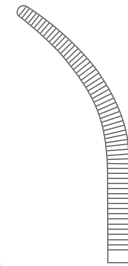

23-415-14
Overholt-Baby Dissecting and Ligature Forcep
Curved
Overall Length 14 cm (5 ½")

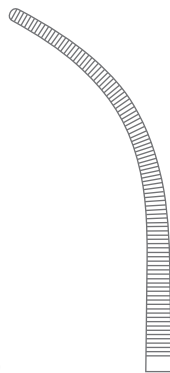

23-417-21
Overholt-Mixer Dissecting and Ligature Forcep
Curved
Overall Length 21.5 cm (8 ½")

Dissecting and Ligature Forceps
 Präparierklemmen
 Pinzas para preparación y ligadura
 Pincès à disséquer et à ligatures
 Pinze per preparazioni e legature

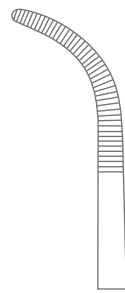

23-421-01
 Fig. 1
 20.5 cm (8")

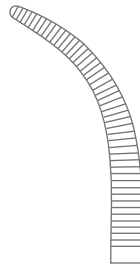

23-421-02
 Fig. 2
 20 cm (8")

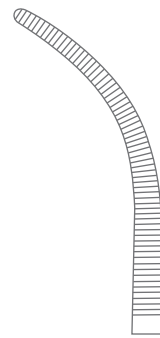

23-421-03
 Fig. 3
 21.5 cm (8 1/2")

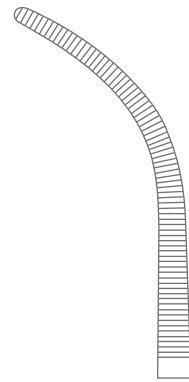

23-421-04
 Fig. 4
 22 cm (8 3/4")

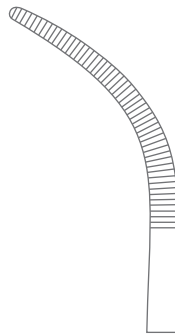

23-421-05
 Fig. 5
 21.5 cm (8 1/2")

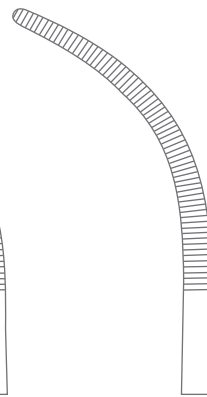

23-421-06
 Fig. 6
 22 cm (8 3/4")



23-421-07
 Fig. 7
 22 cm (8 3/4")

Overholt-Geissendoerfer Dissecting and Ligature Forcep

Dissecting and Ligature Forceps
 Präparierklemmen
 Pinzas para preparación y ligadura
 Pinces à disséquer et à ligatures
 Pinze per preparazioni e legature

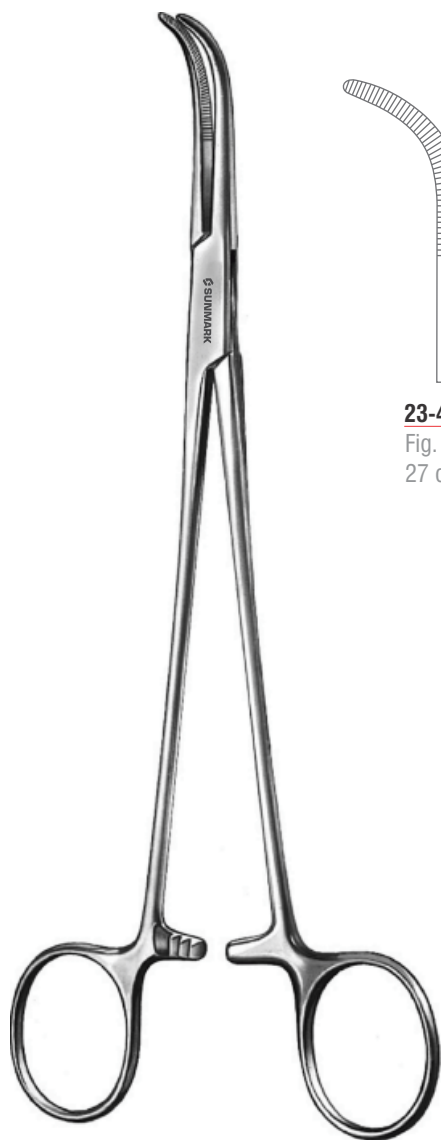

Overholt-Geissendoerfer Dissecting and Ligature Forcep

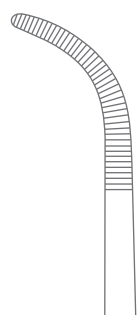

23-423-01
 Fig. 1
 27 cm (10 3/4")

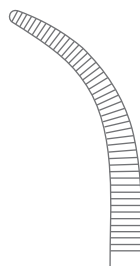

23-423-02
 Fig. 2
 26.5 cm (10 1/2")

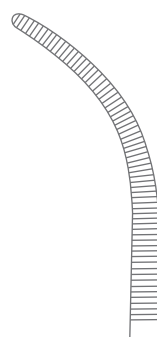

23-423-03
 Fig. 3
 27.5 cm (10 3/4")

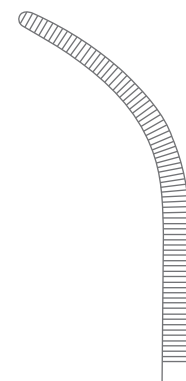

23-423-04
 Fig. 4
 28 cm (11")

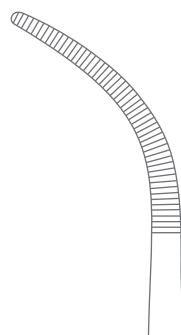

23-423-05
 Fig. 5
 27.5 cm (10 3/4")

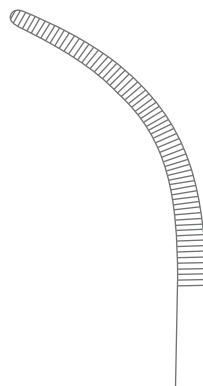

23-423-06
 Fig. 6
 28 cm (11")



23-423-07
 Fig. 7
 27.5 cm (10 3/4")

Dissecting and Ligature Forceps
 Präparierklemmen
 Pinzas para preparación y ligadura
 Pincès à disséquer et à ligatures
 Pinze per preparazioni e legature

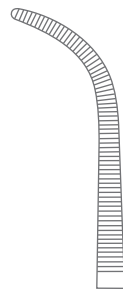
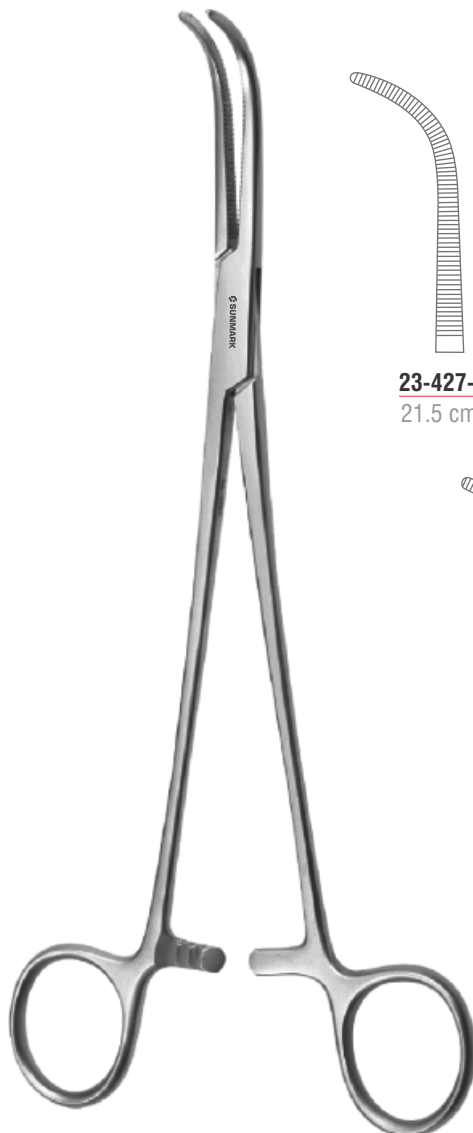

23-427-00
21.5 cm (8 1/2")

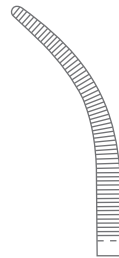

23-427-01
21 cm (8 1/4")

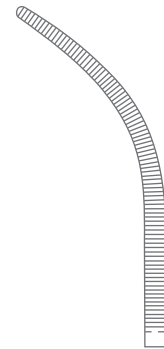

23-427-02
22 cm (8 3/4")

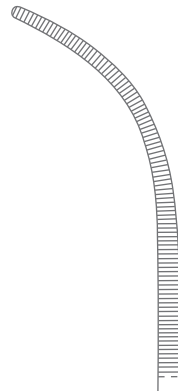

23-427-03
23 cm (9")



23-427-06
22.5 cm (8 3/4")

Overholt-Fine Dissecting and Ligature Forcep
Curved

Dissecting and Ligature Forceps
 Präparierklemmen
 Pinzas para preparación y ligadura
 Pincès à disséquer et à ligatures
 Pinze per preparazioni e legature



Overholt Dissecting and Ligature Forcep
Curved

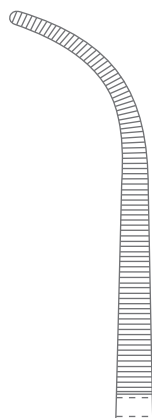

23-429-00
29 cm (11 1/2")

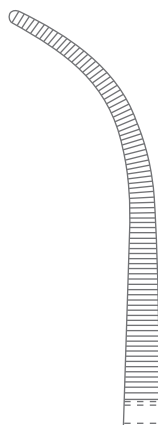

23-429-01
29 cm (11 1/2")

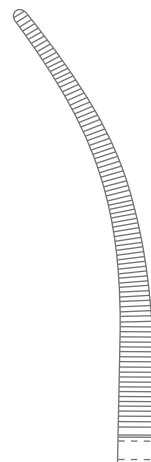

23-429-02
30 cm (11 3/4")

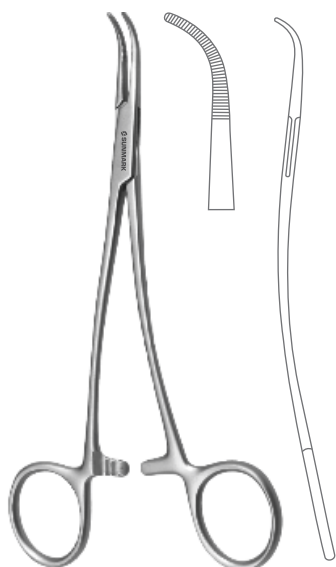

23-431-15
Overholt-Mini Dissecting and Ligature Forcep
Curved, S Shaped
Overall Length 15 cm (6")



23-433-20
Overholt-Mini Dissecting and Ligature Forcep
Curved
Overall Length 20 cm (8")

Dissecting and Ligature Forceps
 Präparierklemmen
 Pinzas para preparación y ligadura
 Pincès à disséquer et à ligatures
 Pinze per preparazioni e legature



Kelly Dissecting and Ligature Forcep

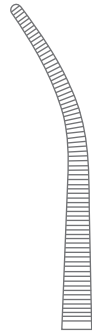

23-441-19
Fig. 1
19.5 cm (7 3/4")



23-441-22
Fig. 1
22.5 cm (8 3/4")



23-441-24
Fig. 1
24.5 cm (9 3/4")



23-443-19
Fig. 2
19 cm (7 1/2")



23-443-22
Fig. 2
22 cm (8 3/4")



23-443-24
Fig. 2
24 cm (9 1/2")



23-445-19
Fig. 3
18.5 cm (7 1/4")



23-445-22
Fig. 3
21.5 cm (8 1/2")



23-445-24
Fig. 3
23.5 cm (9 1/4")

Dissecting and Ligature Forceps
 Präparierklemmen
 Pinzas para preparación y ligadura
 Pinces à disséquer et à ligatures
 Pinze per preparazioni e legature



23-451-28
Lawrence Dissecting and Ligature Forcep
 Curved
 Overall Length 28 cm (11")



23-455-28
Meeker Dissecting and Ligature Forcep
 Right Angled
 Overall Length 28 cm (11")



Mini-Gemini Dissecting and Ligature Forcep
 Curved

23-469-18
 18 cm (7")

23-469-22
 22.5 cm (8 ¾")

23-469-25
 25 cm (9 ¾")

23-469-28
 28.5 cm (11 ¼")

Dissecting and Ligature Forceps
 Präparierklemmen
 Pinzas para preparación y ligadura
 Pincès à disséquer et à ligatures
 Pinze per preparazioni e legature



Gemini Dissecting and Ligature Forcep
 Curved

Dissecting and Ligature Forceps
 Präparierklemmen
 Pinzas para preparación y ligadura
 Pinces à disséquer et à ligatures
 Pinze per preparazioni e legature



Rumel Dissecting and Ligature Forcep
Curved

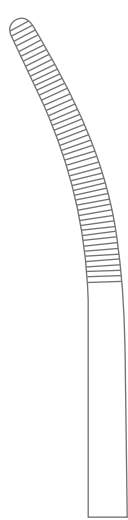

23-475-01
24 cm (9 1/2")

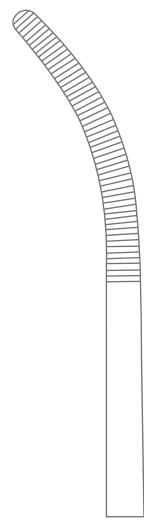

23-475-02
23.5 cm (9 1/2")

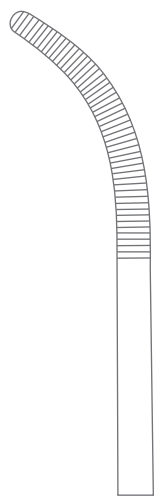

23-475-03
23 cm (9")

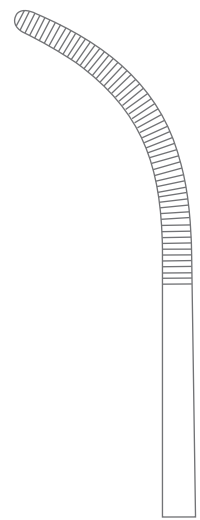

23-475-04
24 cm (9 1/2")

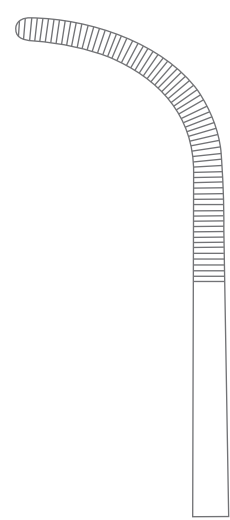

23-475-05
23.5 cm (9 1/4")

Dissecting and Ligature Forceps
 Präparierklemmen
 Pinzas para preparación y ligadura
 Pincers à disséquer et à ligatures
 Pinze per preparazioni e legature



23-479-01
29.5 cm (11 1/2")

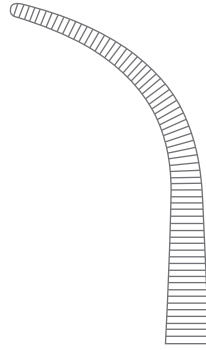
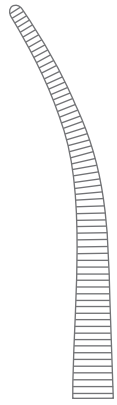

23-479-02
28.5 cm (11 1/4")

Zenker Dissecting and Ligature Forcep
Curved



23-481-23
Kieback Dissecting and Ligature Forcep
Curved
Overall Length 23.5 cm (9 1/4")

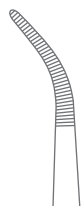
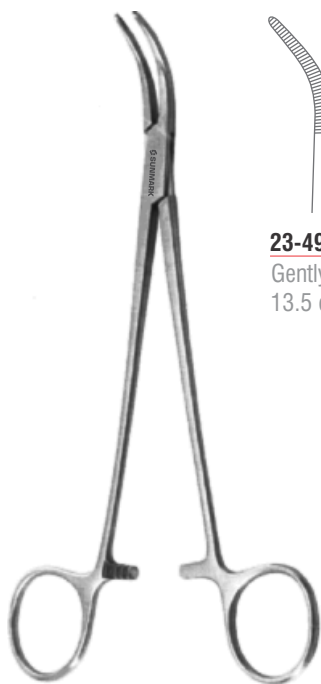

23-491-01
Gently Curved
13.5 cm (5 1/4")

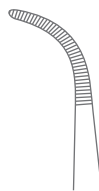

23-491-02
Strongly Curved
13 cm (5")

Mixer-Baby Dissecting and Ligature Forcep

Dissecting and Ligature Forceps
Präparierklemmen
Pinzas para preparación y ligadura
Pincès à disséquer et à ligatures
Pinze per preparazioni e legature



23-493-14
Mixer-Baby Dissecting and Ligature Forcep
Curved
Overall Length 13.5 cm (5 1/4")



23-495-18
Mixer-Baby Dissecting and Ligature Forcep
Curved
Overall Length 18.5 cm (7 1/4")



Mixer Dissecting and Ligature Forcep
Right Angled

23-497-15
16 cm (6 1/4")

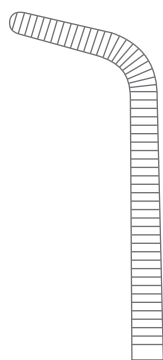

23-497-19
18 cm (7")



23-499-22
22.5 cm (8 3/4")

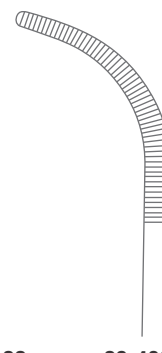

23-499-23
23 cm (9")

Mixer Dissecting and Ligature Forcep
Curved

Dissecting and Ligature Forceps
 Präparierklemmen
 Pinzas para preparación y ligadura
 Pincès à disséquer et à ligatures
 Pinze per preparazioni e legature



23-501-22
 22.5 cm (8 ¾")

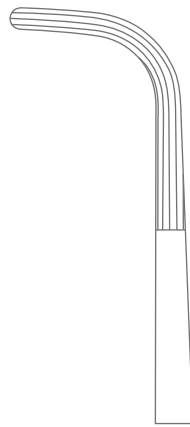

23-501-25
 26 cm (10 ¼")

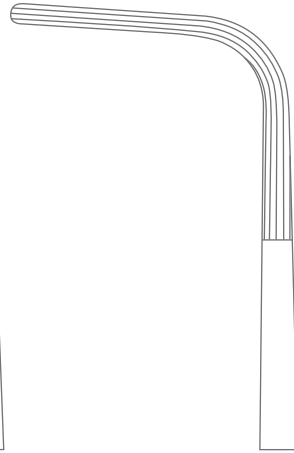

23-501-28
 28 cm (11")

Mixer Dissecting and Ligature Forcep
 Right Angled, Longitudinally Serrated



23-505-22
Mc Quigg-Mixer Dissecting and Ligature Forcep
 Right Angled, Longitudinally Serrated
 Overall Length 23.5 cm (9 ¼")



23-509-19
Mixer-O'Shaughnessy Dissecting and Ligature Forcep
 Curved
 Overall Length 18.5 cm (7")

Dissecting and Ligature Forceps
 Präparierklemmen
 Pinzas para preparación y ligadura
 Pincès à disséquer et à ligatures
 Pinze per preparazioni e legature



O'Shaughnessy Dissecting and Ligature Forcep
 Curved

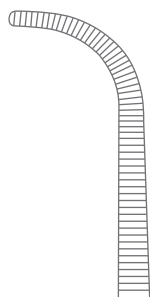

23-511-14
 15 cm (6")

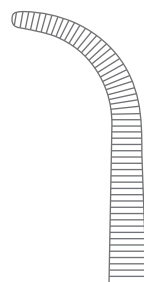

23-511-17
 18 cm (7")



23-511-20
 20 cm (8")

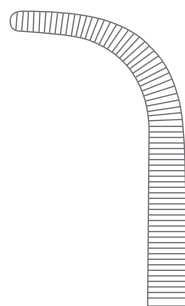

23-511-23
 23 cm (9")

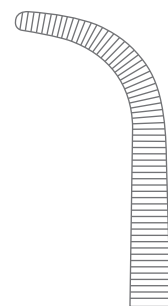

23-511-26
 26 cm (10 ¼")

Dissecting and Ligature Forceps
 Präparierklemmen
 Pinzas para preparación y ligadura
 Pincès à disséquer et à ligatures
 Pinze per preparazioni e legature



Wickstroem Dissecting and Ligature Forcep
 Right Angled

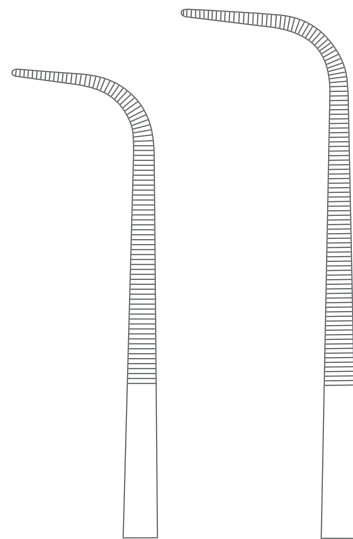

23-517-21
 21 cm (8 ¼")

23-517-24
 24.5 cm (9 ¾")



23-519-18
Lahey Dissecting and Ligature Forcep
 Curved
 Overall Length 18.5 cm (7 ¼")

Dissecting and Ligature Forceps
Präparierklemmen
Pinzas para preparación y ligadura
Pinces à disséquer et à ligatures
Pinze per preparazioni e legature



23-523-20
20 cm (8")

23-523-25
25 cm (9 3/4")

23-523-27
27.5 cm (10 3/4")

Kantrowitz Dissecting and Ligature Forcep
Right Angled

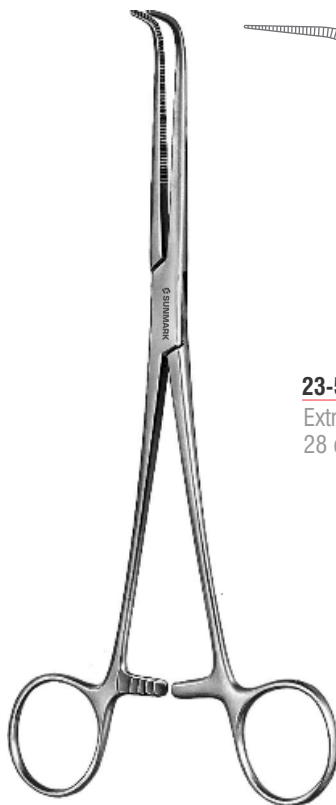

23-527-28
Extra Delicate
28 cm (11")

23-529-28
Delicate
28 cm (11")

Barre Dissecting and Ligature Forcep



Dissecting and Ligature Forceps
 Präparierklemmen
 Pinzas para preparación y ligadura
 Pincès à disséquer et à ligatures
 Pinze per preparazioni e legature

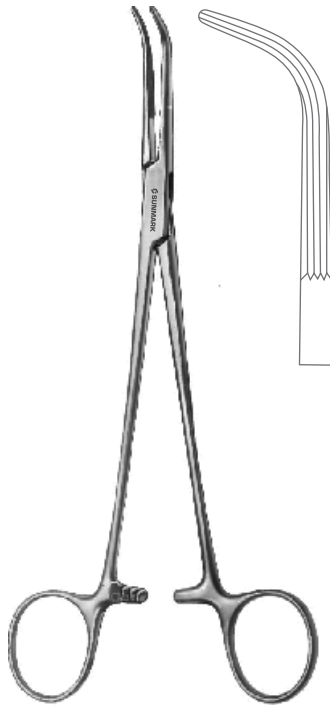

23-535-19
Lahey (Sweet) Bile Duct Clamp
 Curved
 Overall Length 19.5 cm (7 ¾")



23-537-23
Lahey Bile Duct Clamp
 Angled
 Overall Length 22.5 cm (8 ¾")



23-539-23
Lahey Bile Duct Clamp
 Curved
 Overall Length 23 cm (9")

Dissecting and Ligature Forceps, Tangential Forceps
 Präparierklemmen, Tangentialklemmen
 Pinzas para preparación y ligadura, Pinzas tangenciales
 Pinces à disséquer et à ligatures, Pinces tangentielles
 Pinze per preparazioni e legature, Pinze tangenziali



23-541-24
Finochietto Dissecting and Ligature Forcep
 Right Angled
 Overall Length 24 cm (9 1/2")



23-551-01
 Fig. 1
 25 cm (9 3/4")

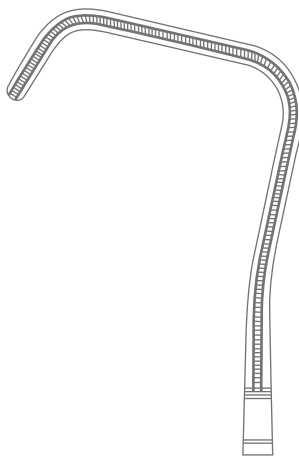

23-551-02
 Fig. 2
 27 cm (10 3/4")

URO-Tangential Atrauma Occlusion Clamp



Kidney Pedicle Clamps
Nierenstielklemmen
Pinzas para pedículo renal
Pince-clamps pour pédicules rénaux
Pinze per peduncoli renali



23-561-23
23 cm (9")

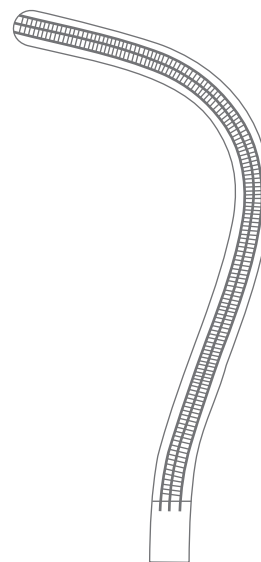
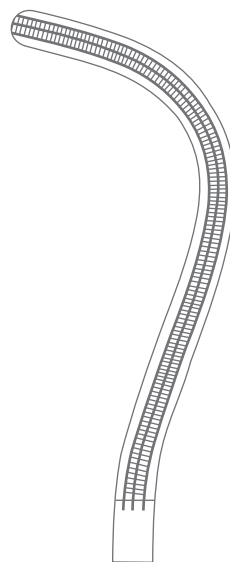

23-561-24
24 cm (9 1/2")

Guyon Atrauma Kidney Pedicle Clamp
Curved

Kidney Pedicle Clamps
Nierenstielklemmen
Pinzas para pedículo renal
Pince-clamps pour pédicules rénaux
Pinze per peduncoli renali

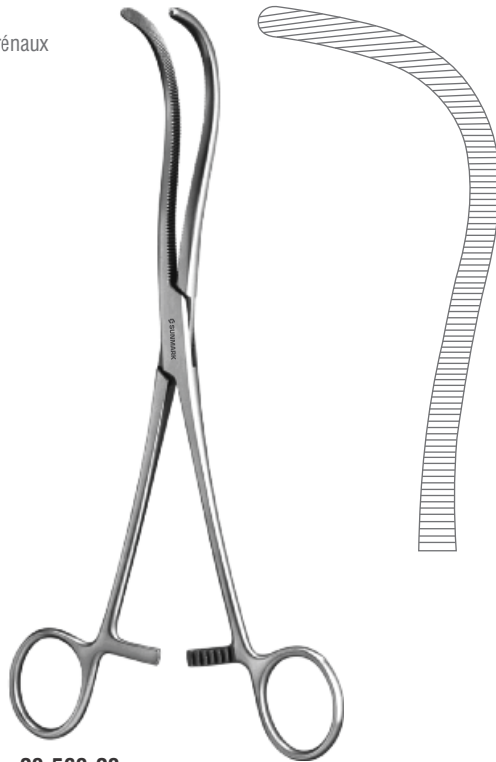

23-563-23
Guyon Kidney Pedicle Clamp
Curved
Overall Length 24 cm (9 1/2")



23-565-20
19.5 cm (7 3/4")

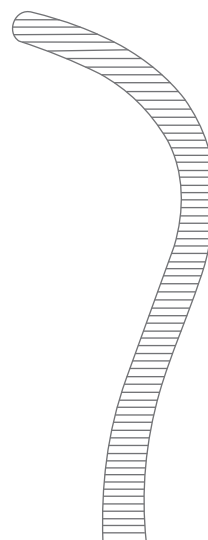

23-565-22
21.5 cm (8 1/2")

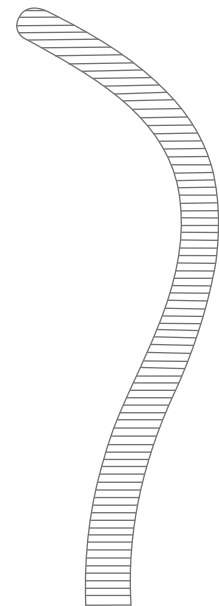

23-565-24
24 cm (9 1/2")

Guyon Kidney Pedicle Clamp
Curved



Kidney Pedicle Clamps
 Nierenstielklemmen
 Pinzas para pedículo renal
 Pince-clamps pour pédicules rénaux
 Pinze per peduncoli renali

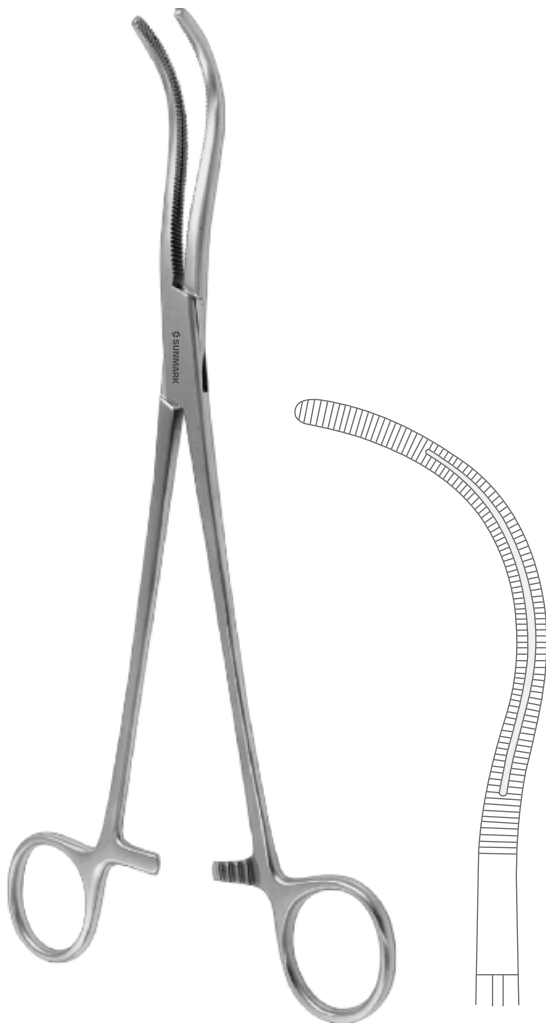

23-569-23
Stille Kidney Pedicle Clamp
 Curved, Grooved
 Overall Length 23 cm (9")



23-571-23
Herrick Kidney Pedicle Clamp
 Double Angled, Longitudinally Serrated
 Overall Length 23 cm (9")

Bile Duct Clamps, Dissecting and Ligature Forceps
 Gallenkanalklemmen, Präparierklemmen
 Pinzas para conducto biliar, Pinzas para preparación y ligadura
 Pincers pour les voies biliaires, Pincers à disséquer et à ligatures
 Pinze per vie biliari, Pinze per preparazioni e legature



23-581-21
Desjardins Bile Duct Clamp
 Curved Downwards
 Overall Length 21 cm (8 1/4")



23-583-21
Nissen Bile Duct Clamp
 Curved Downwards
 Overall Length 21.5 cm (8 1/2")



Gray Dissecting and Ligature Forcep
 Curved S Shaped

23-591-01
 22 cm (8 3/4")

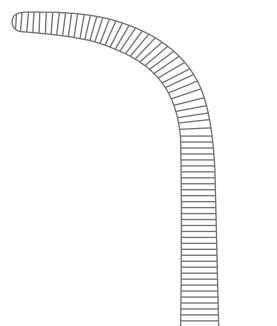

23-591-02
 22 cm (8 3/4")

Hysterectomy Forceps
Hysterektomieklennen
Pinzas para histerectomia
Pinces à hystérectomie
Pinze per isterectomia



23-594-21
Straight
20.5 cm (8")

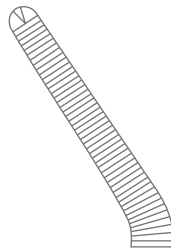

23-595-21
Curved
20 cm (8")

Phaneuf Hysterectomy Forcep
1 x 2 Teeth



23-597-20
Curved
20.5 cm (8")

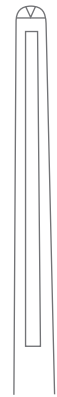

23-598-20
Straight
20 cm (8")

Maingot Hysterectomy Forcep
1 x 2 Teeth



Hysterectomy Forceps
Hysterektomieklemmen
Pinzas para histerectomía
Pinces à hystérectomie
Pinze per isterectomia



Heaney-Ballentine Hysterectomy Forcep
Overall Length 21.5 cm (8 1/2")



23-600-21
Straight



23-601-21
Straight



23-604-21
Heaney-Razek Hysterectomy Forcep
Straight
Overall Length 21 cm (8 1/4")

Hysterectomy Forceps
Hysterektomieklennen
Pinzas para histerectomia
Pinces à hystérectomie
Pinze per isterectomia



Heaney Hysterectomy Forcep

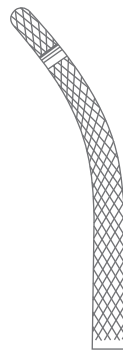

23-607-19
Curved, 1 Tooth
19.5 cm (7 ¾")

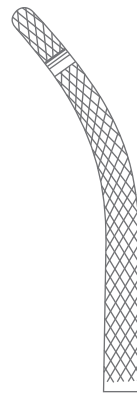

23-607-21
Curved, 1 Tooth
21.5 cm (8 ½")

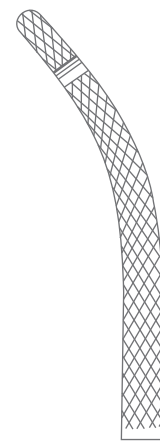

23-607-23
Curved, 1 Tooth
24 cm (9 ½")



23-609-19
Curved, 2 Tooth
19.5 cm (7 ¾")



23-609-21
Curved, 2 Tooth
21.5 cm (8 ½")



23-609-23
Curved, 2 Tooth
24 cm (9 ½")

Hysterectomy Forceps
Hysterektomieklemmen
Pinzas para histerectomía
Pinces à hystérectomie
Pinze per isterectomia



23-617-25
Parker-Kerr Anastomosis Clamp
Curved With Longitudinally Serrated Jaws
Overall Length 25 cm (10")



Dick Atrauma Vaginal Clamp
Angled

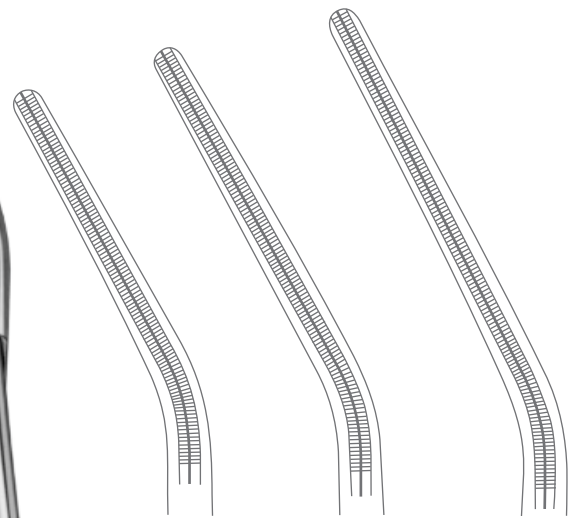

23-621-25 25.5 cm (10")
23-621-25 26.5 cm (10 1/2")
23-621-25 27.5 cm (10 3/4")

Hysterectomy Forceps
Hysterektomieklemmen
Pinzas para histerectomia
Pinces à hystérectomie
Pinze per isterectomia



23-625-25
Wertheim Atrauma Vaginal Clamp
Right Angled
Overall Length 25 cm (9 3/4")



23-629-21
Wertheim-Cullen Vaginal Clamp
Overall Length 21 cm (8 1/4")

Hysterectomy Forceps
 Hysterektomieklappen
 Pinzas para histerectomia
 Pincas à hysterectomie
 Pinze per isterectomia



Zeppelin Hysterectomy Clamp



23-630-21
 Straight
 21.5 cm (8 ½")

23-630-24
 Straight
 24 cm (9 ½")

23-630-30
 Straight
 30 cm (12")



23-631-21
 Slightly Curved
 21.5 cm (8 ½")

23-631-24
 Slightly Curved
 24 cm (9 ½")

23-631-30
 Slightly Curved
 30 cm (12")



23-632-21
 Medium Curved
 21.5 cm (8 ½")

23-632-24
 Medium Curved
 24 cm (9 ½")

23-632-30
 Medium Curved
 30 cm (12")

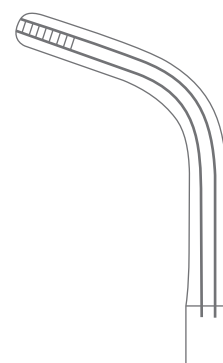

23-633-21
 Strongly Curved
 21.5 cm (8 ½")

23-633-24
 Strongly Curved
 24 cm (9 ½")

23-633-30
 Strongly Curved
 30 cm (12")



23-634-01
Zeppelin Hysterectomy Clamp
 Curved, S Shaped
 Overall Length 24 cm (8 ½")

Hysterectomy Forceps
Hysterektomieklappen
Pinzas para histerectomia
Pincas à hystérectomie
Pinze per isterectomia



23-635-10

Fig. 1
21.5 cm (8 ½")

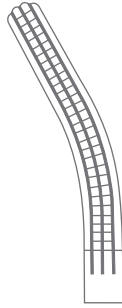

23-635-20

Fig. 2
21 cm (8 ¼")

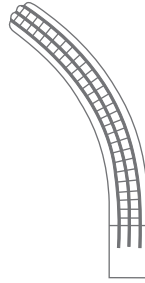

23-635-30

Fig. 3
20.5 cm (8")

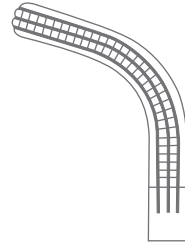

23-635-40

Fig. 4
20 cm (8")

Heaney (Rogers) Hysterectomy Forcep



23-637-10

Fig. 1
25.5 cm (10")

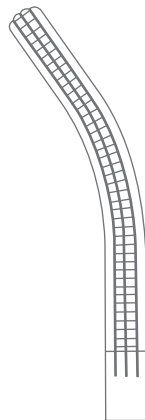

23-637-20

Fig. 2
25 cm (9 ¾")

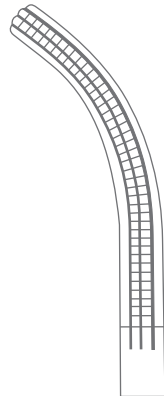

23-637-30

Fig. 3
24.5 cm (9 ¾")



23-639-22

Wertheim Hysterectomy Forcep
Angled
Overall Length 22 cm (8 ¾")

Wertheim (Rogers) Hysterectomy Forcep

Hysterectomy Forceps
Hysterektomieklemmen
Pinzas para histerectomía
Pinces à hystérectomie
Pinze per isterectomia

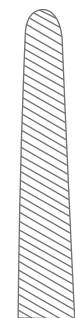

23-642-24
Straight

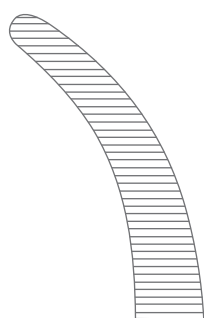

23-643-24
Curved



23-646-24
Straight
1 x 2 Teeth

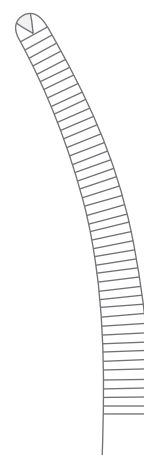

23-647-24
Curved
1 x 2 Teeth

Segond-Landau Hysterectomy Forcep
Overall Length 24 cm (9 1/2")

Holzbach Hysterectomy Forcep
Overall Length 24.5 cm (9 3/4")



Hysterectomy Forceps
Hysterektomieklennen
Pinzas para histerectomía
Pinces à hystérectomie
Pinze per isterectomia



23-648-20
Straight

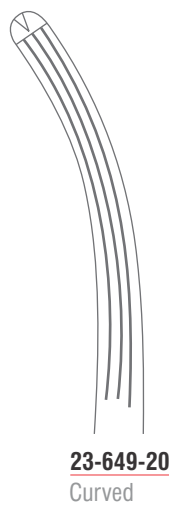

23-649-20
Curved



23-651-20
Berkeley-Bonney Hysterectomy Forcep
Curved
Overall Length 20 cm (8")



Hysterectomy Forceps
Hysterektomieklemmen
Pinzas para histerectomía
Pinces à hystérectomie
Pinze per isterectomia



Kieback Hysterectomy Forcep
Overall Length 25 cm (9 3/4")



23-654-25
Straight



23-655-25
Curved

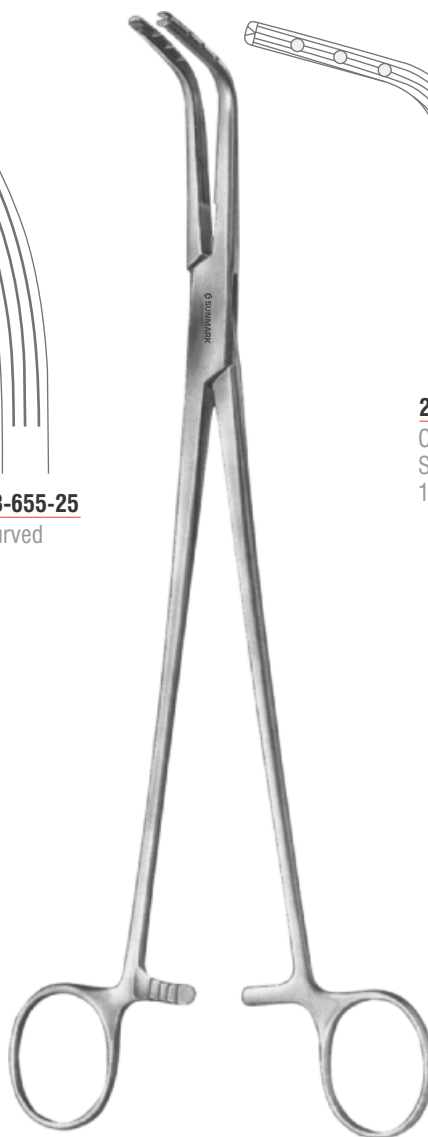

Burke Hysterectomy Forcep
Overall Length 25 cm (9 3/4")



23-657-25
Curved
Short Jaws
1 x 2 Teeth

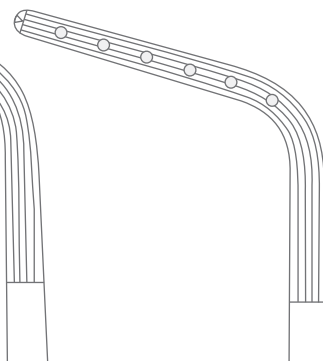

23-659-25
Curved
Long Jaws
1 x 2 Teeth



Hysterectomy Forceps
Hysterektomieklennen
Pinzas para histerectomia
Pinces à hystérectomie
Pinze per isterectomia



23-661-23
Moynihan Hysterectomy Forcep
Curved
Overall Length 23 cm (9")



23-663-24
Moynihan Hysterectomy Forcep
Curved
Overall Length 23.5 cm (9 1/4")

Hysterectomy Forceps
Hysterektomieklemmen
Pinzas para histerectomía
Pinces à hystérectomie
Pinze per isterectomia



23-667-25
Wertheim Hysterectomy Forcep
Curved
Overall Length 26 cm (10 1/4")



23-669-22
Curved
1 x 2 Teeth

23-671-23
Curved
1 x 2 Teeth



Fergusson Angiotribe
Ophthalmologie Instrumente
Oftalmología Instrumentos
Ophthalmologie Instruments
Oftalmologia Strumenti



Fergusson Angiotribe

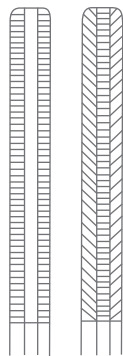

23-680-16
Straight
16 cm (6 1/4")

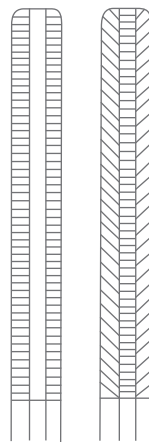

23-680-20
Straight
20 cm (8")

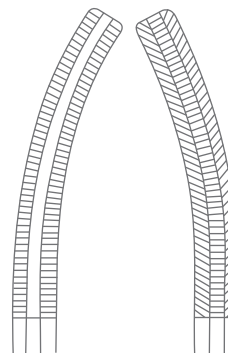

23-681-16
Curved
16 cm (6 1/4")

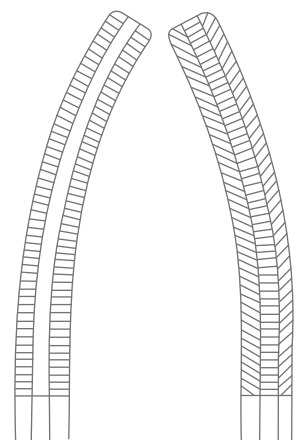

23-681-20
Curved
20 cm (8")

Peritoneum Forceps
Peritoneumklemmen
Pinzas para peritoneo
Pince pour le péritoine
Pinze per peritoneo



23-685-14
Mikulicz-Baby Peritoneum Forcep
Curved, 1 x 2 Teeth
Overall Length 14 cm (5 3/4")



23-687-18
18.5 cm (7 1/4")

23-689-20
20 cm (8")

23-691-20
20 cm (8")

Mikulicz Peritoneum Forcep
Curved, 1 x 2 Teeth



Peritoneum Forceps
Peritoneumklemmen
Pinzas para peritoneo
Pince pour le péritoine
Pinze per peritoneo



23-693-24
Mikulicz Peritoneum Forcep
Curved, Longitudinal Serrations, 1 x 2 Teeth
Overall Length 24.5 cm (9 3/4")



23-693-24
Mikulicz Peritoneum Forcep
Curved, 1 x 2 Teeth
Overall Length 20.5 cm (8")

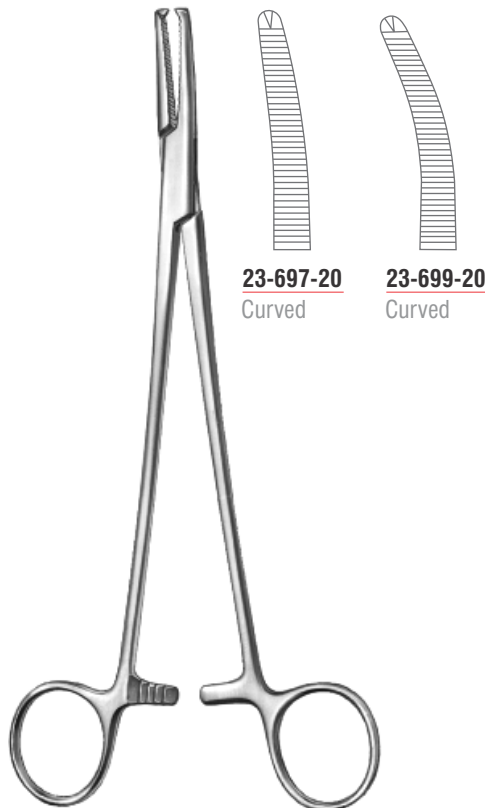

Faure Peritoneum Forcep
Overall Length 21 cm (8 1/4")

Towel Clamps
Tuchklemmen
Pinzas de campo
Pinces à champs
Pinze fissatele



23-751-18
Doyen Towel Clamp
Overall Length 18 cm (7")



23-755-09
Schaedel Towel Clamp
Sharp
Overall Length 9 cm (3 1/2")



23-761-05
Jones Towel Clamp
Sharp

23-761-09
5.5 cm (2 1/2")

23-761-09
8.5 cm (3 1/4")



23-765-09
Martin-Jones Towel Clamp
Sharp, With Cable Holder
Overall Length 8.5 cm (3 1/4")

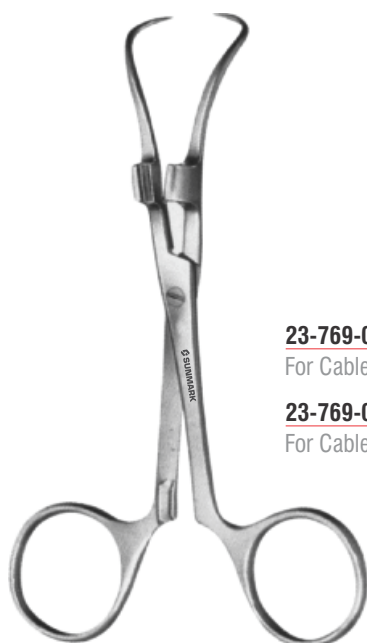

23-769-01
For Cable Up To 5 mm

23-769-02
For Cable Up To 13 mm

Robin Towel Clamp
With Cable Holder
Overall Length 13.5 cm (5 1/4")

Towel Clamps
Tuchklemmen
Pinzas de campo
Pinces à champs
Pinze fissatele



23-771-11
Backhaus Towel Clamp
With Tube Holder
Overall Length 13 cm (5")



Backhaus Towel Clamp



23-773-08
9 cm (3 1/2")

23-773-11
11.5 cm (4 1/2")

23-773-13
13 cm (5")

23-773-15
16 cm (6 1/4")



23-777-13
Roeder Towel Clamp
Overall Length 13.5 cm (5 1/4")



Lorna Towel Clamp
Fine Serrated, Wide Jaw

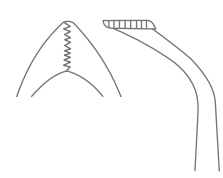

23-781-10
9.5 cm (3 3/4")

23-781-13
13 cm (5")

Towel Clamps
Tuchklemmen
Pinzas de campo
Pinces à champs
Pinze fissatele



23-785-16
Bernhard Towel Clamp
Overall Length 16.5 cm (6 1/2")



23-787-10
10.5 cm (4")
23-787-13
13.5 cm (5 1/4")



Non Perforating Towel Clamp

23-791-10
10 cm (4")
23-791-13
13.5 cm (5 1/4")

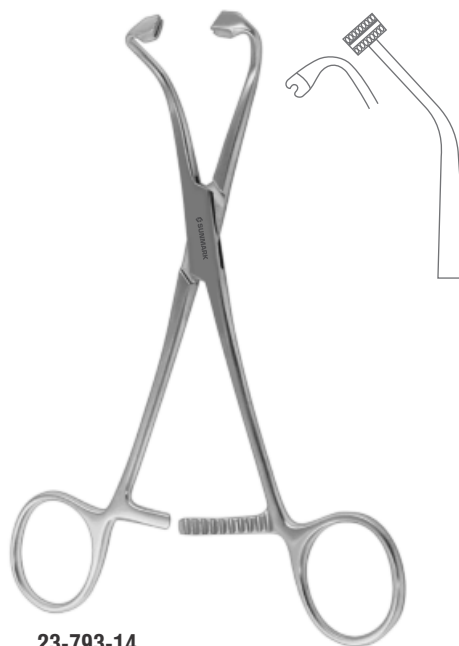

23-793-14
Peers-Bertram Towel Clamp
With Jaw for Tube Fixation
Overall Length 16.5 cm (6 1/2")

Towel Clamps, Tubing Clamps
 Tuchklemmen, Schlauchklemmen
 Pinzas de campo, Pinzas para tubos
 Pincès à champs, Pincès presse-tubes
 Pinze fissatele, Pinze serratubi



Towel Clamp
 For Paper Clothes

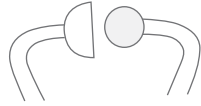

23-795-11
 11.5 cm (4 ½")

23-795-14
 14 cm (5 ½")

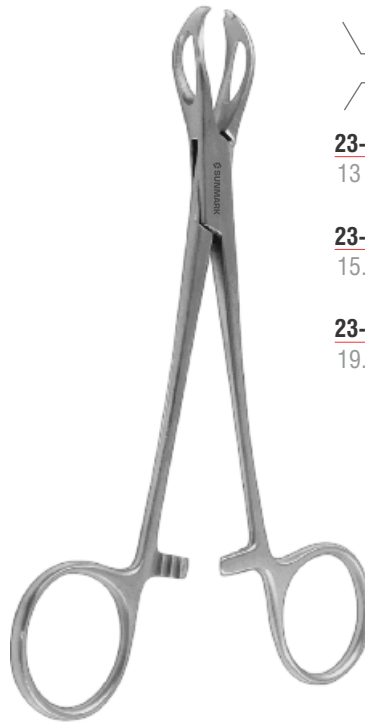

Lane Towel Clamp



23-799-13
 13 cm (5")

23-799-15
 15.5 cm (6")

23-799-20
 19.5 cm (7 ¾")



23-801-19
Moynihan Towel Clamp
 2 x 2 Teeth
 Overall Length 19 cm (7 ½")



23-850-14
Klinikum-Berlin Tubing Clamp
 Extra Long Ratchet
 Overall Length 14 cm (5 ½")



Presbyterian Tubing Clamp

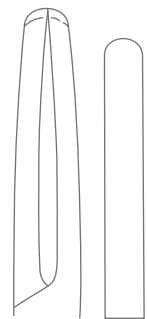

23-852-16
 16.5 cm (6 ½")

23-852-18
 18 cm (7")

Tubing Clamps
Schlauchklemmen
Pinzas para tubos
Pincas presse-tubes
Pinze serratubi



Tubing Clamp

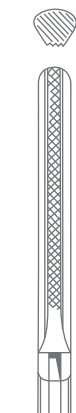

23-860-15
15.5 cm (6")

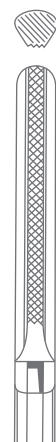

23-860-18
19 cm (7 1/2")

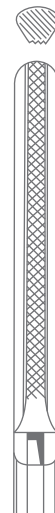

23-860-20
20.5 cm (8")



Tubing Clamp
With Safety Guard

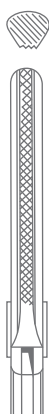

23-862-15
15.5 cm (6")

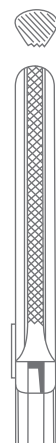

23-862-18
19 cm (7 1/2")

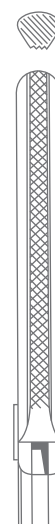

23-862-20
20.5 cm (8")

Tube Milking Rollers
Rollenklemmen
Pinzas de rodillos
Pinces à roulette
Pinze con rotelle



23-890-00
Brompton Tube Milking Roller
Standard

Dressing Forceps
Tupferzangen
Pinzas para tapones
Pinces à tampons
Pinze per tamponi



Ulrich Dressing Forceps

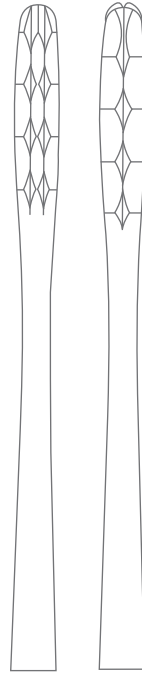

73-100-22
Straight
22.5 cm (8 3/4")

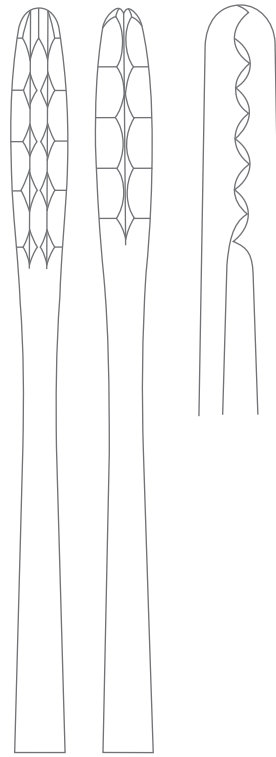

73-100-27
Straight
26.5 cm (10 1/2")



73-101-22
Curved
22.5 cm (8 3/4")

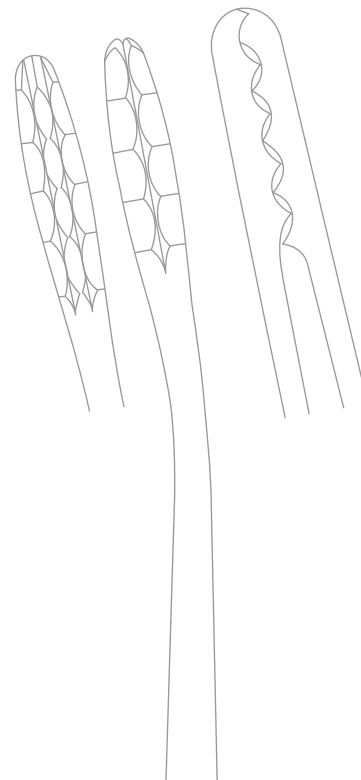

73-101-27
Curved
26.5 cm (10 1/2")

Dressing Forceps
Tupferzangen
Pinzas para tapones
Pincès à tampons
Pinze per tamponi



73-111-13
Bryant Dressing Forcep
Curved
Overall Length 13 cm (5")



Lister Sinus Forcep

73-120-13
Straight
13 cm (5")

73-120-16
Straight
16 cm (6 1/4")

73-120-18
Straight
18 cm (7")

73-121-18
Curved
18 cm (7")

COTTON SWAB AND DRESSING FORCEPS



Dressing Forceps
Tupferzangen
Pinzas para tapones
Pinces à tampons
Pinze per tamponi



Martin Dressing Forcep

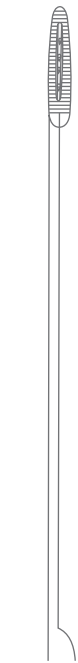

73-130-17
Straight
17.5 cm (7")



73-130-25
Straight
25.5 cm (10")

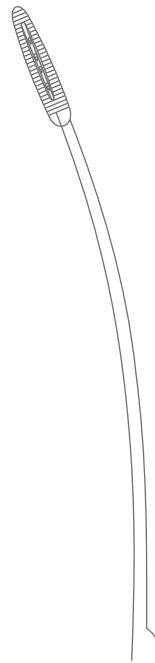

73-131-17
Curved
17 cm (6 3/4")



Dressing Forceps
 Tupferzangen
 Pinzas para tapones
 Pincès à tampons
 Pinze per tamponi

COTTON SWAB AND DRESSING FORCEPS



Gross-Maier Dressing Forcep



73-150-20
 Straight
 With Ratchet
 20.5 cm (8")

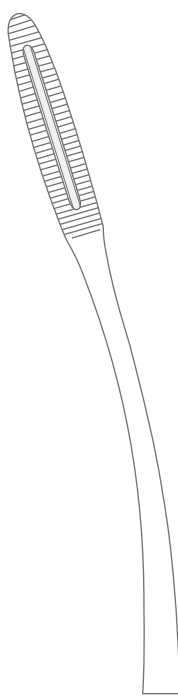

73-151-20
 Curved
 With Ratchet
 20 cm (8")



73-152-20
 Straight
 Without Ratchet
 20.5 cm (8")

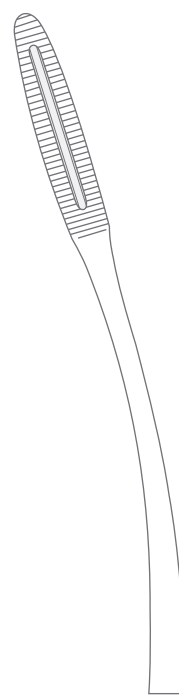

73-153-20
 Curved
 Without Ratchet
 20.5 cm (8")

73-150-22
 Straight
 With Ratchet
 22 cm (8 3/4")

73-151-22
 Curved
 With Ratchet
 21.5 cm (8 1/2")

73-152-22
 Straight
 Without Ratchet
 22 cm (8 3/4")

73-153-22
 Curved
 Without Ratchet
 22 cm (8 3/4")

73-150-27
 Straight
 With Ratchet
 26.5 cm (10 1/2")

73-151-27
 Curved
 With Ratchet
 26 cm (10 1/4")

73-152-27
 Straight
 Without Ratchet
 26.5 cm (10 1/2")

73-153-27
 Curved
 Without Ratchet
 26.5 cm (10 1/2")



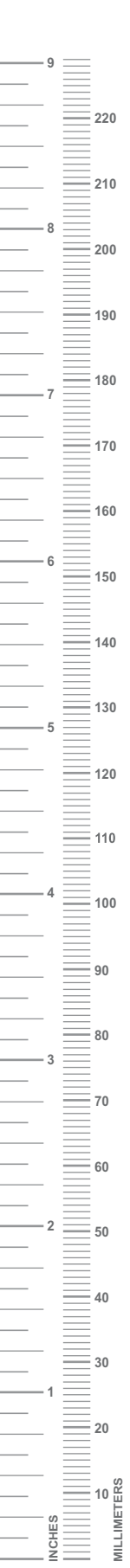

Dressing Forceps
Tupferzangen
Pinzas para tapones
Pinces à tampons
Pinze per tamponi



Pelkmann Foreign Body Forcep
Overall Length 26 cm (10 1/4")

73-160-26
Straight

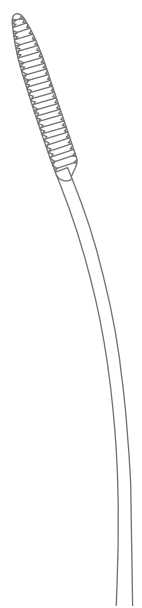

73-161-26
Curved



Duplay Sponge Holding Forcep
Overall Length 21 cm (8 1/4")

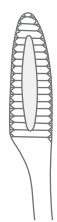

73-164-21
Straight

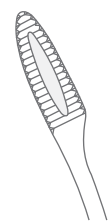

73-165-21
Curved

Dressing Forceps
Tupferzangen
Pinzas para tapones
Pincers à tampons
Pinze per tamponi

COTTON SWAB AND DRESSING FORCEPS

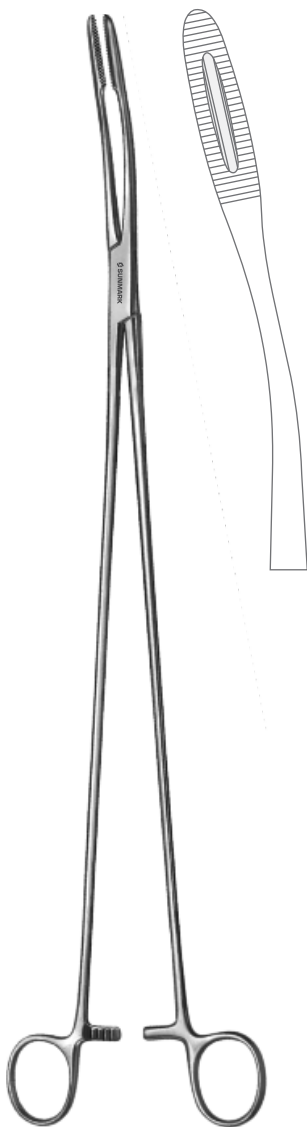

73-171-40
Tunneling Forcep
Curved
Overall Length 39.5 cm (15 ½")



73-180-25
Collin Dressing Forcep
Straight
Overall Length 25.5 cm (10")



73-191-25
Cheron Dressing Forcep
Straight
Overall Length 23.5 cm (9 ¼")

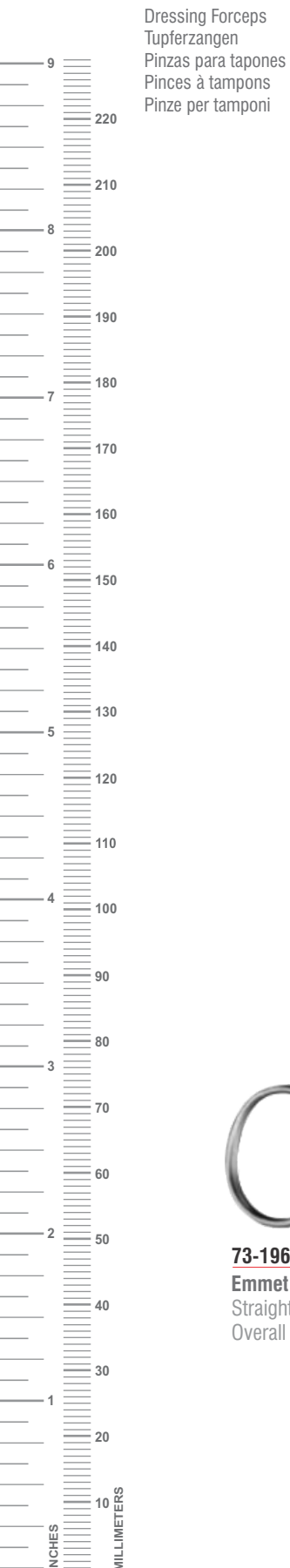

Dressing Forceps
Tupferzangen
Pinzas para tapones
Pincers à tampons
Pinze per tamponi



73-196-21
Emmet Dressing Forcep
Straight
Overall Length 21 cm (8 1/4")



73-200-26
Bozemann Sponge Holding Forcep
Straight
Overall Length 26 cm (10 1/4")

Dressing Forceps
Tupferzangen
Pinzas para tapones
Pinces à tampons
Pinze per tamponi

COTTON SWAB AND DRESSING FORCEPS



73-201-20
Curved
20.5 cm (8")



73-201-26
Curved
26.5 cm (10 ½")

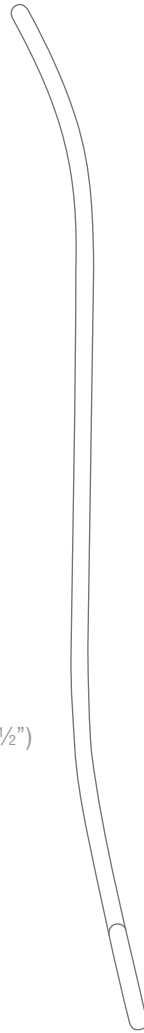

73-203-26
Bozemmann-Douglas Sponge Holding Forcep
Curved, S Shaped
Overall Length 26 cm (10 ¼")

Bozemmann Sponge Holding Forcep
Curved, S Shaped

Dressing Forceps
Tupferzangen
Pinzas para tapones
Pinces à tampons
Pinze per tamponi



73-220-20
Heywood-Smith Sponge Holding Forcep
Straight
Overall Length 20 cm (8")



73-222-21
Heywood-Smith Sponge Holding Forcep
Straight
Overall Length 21 cm (8 1/4")

Dressing Forceps
Tupferzangen
Pinzas para tapones
Pinces à tampons
Pinze per tamponi

COTTON SWAB AND DRESSING FORCEPS



73-231-24
Mcclintock Ovum Forcep
Overall Length 24 cm (9 ½")



73-250-24
Bergmann Sponge Holding Forcep
Straight
Overall Length 24 cm (9 ½")



Dressing Forceps
Tupferzangen
Pinzas para tapones
Pinces à tampons
Pinze per tamponi



Foerster Sponge Holding Forcep

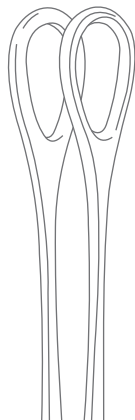

73-300-25
Straight
Smooth Jaws
25 cm (9 3/4")



73-301-25
Curved
Smooth Jaws
25 cm (9 3/4")

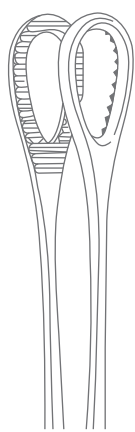

73-350-18
Straight
18 cm (7")

73-350-20
Straight
20.5 cm (8")

73-350-25
Straight
25 cm (9 3/4")

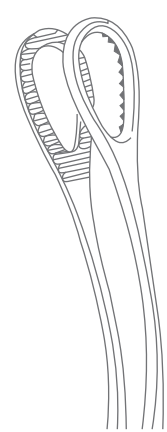

73-351-18
Curved
18 cm (7")

73-351-20
Curved
20.5 cm (8")

73-351-25
Curved
24.5 cm (9 3/4")

Dressing Forceps
Tupferzangen
Pinzas para tapones
Pincers à tampons
Pinze per tamponi

COTTON SWAB AND DRESSING FORCEPS



Foerster Sponge Holding Forcep



73-360-25
Straight
25 cm (9 3/4")

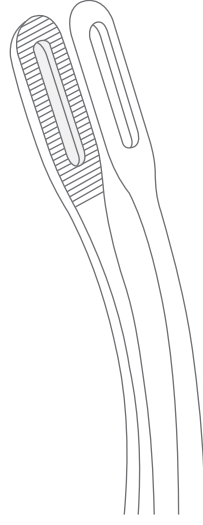

73-361-25
Curved
24.5 cm (9 3/4")

Operating Scissors
Chirurgische Scheren
Tijeras quirúrgicas
Ciseaux chirurgicaux
Forbici per chirurgia



73-380-18
18.5 cm (7 1/4")

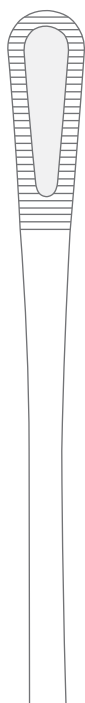

73-380-25
24.5 cm (9 3/4")



73-384-24
Bonney Sponge Holding Forcep
Straight
Overall Length 24.5 cm (9 1/2")

Micro Hooklets, Skin Hooks
 Mikrohäkchen, Hauthäkchen
 Micro Ganchitos, Ganchitos de piel
 Micro Crochetes, Crochetes pour le peau
 Micro Divaricatori, Divaricatori per pelle



78-012-01
Fig. 1



78-012-02
Fig. 2



Gillies Skin Hook
Overall Length 18 cm (7")



78-014-15
Kilner Skin Hook
Sharp
Overall Length 14.5 cm (5 3/4")



78-016-01
Sharp
13 cm (5")



78-016-02
Blunt
13 cm (5")



78-016-03
Sharp
18 cm (7")



78-016-04
Blunt
18 cm (7")

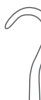

Frazier Delicate Hook



Micro Hooklets, Skin Hooks
 Mikrohäkchen, Hauthäkchen
 Micro Ganchitos, Ganchitos de piel
 Micro Crochetes, Crochetes pour le peau
 Micro Divaricatori, Divaricatori per pelle



Kleine78-Kutz Delicate Hook
 Overall Length 16 cm (6 1/4")

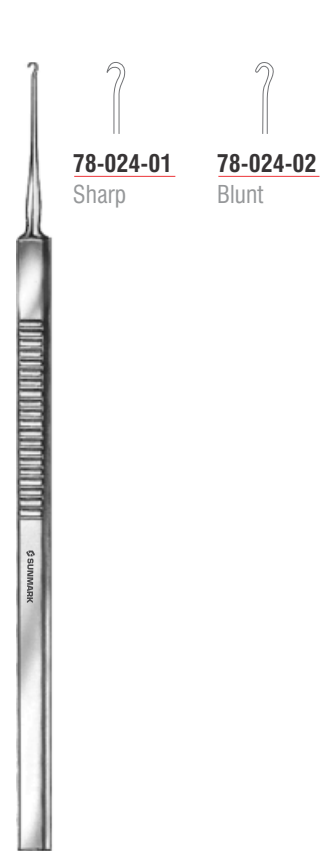

Graefe Delicate Hook
 Overall Length 15 cm (6")

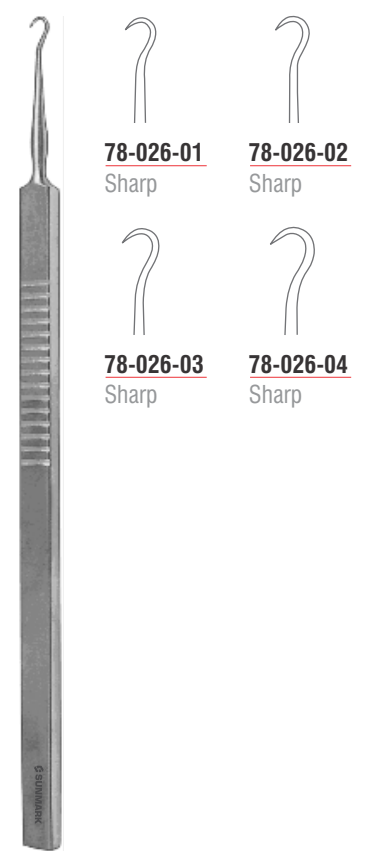

Skin Hook
 Overall Length 16 cm (6 1/4")

Skin Hooks, Hooklets
 Hauthäkchen, Wundhäkchen
 Ganchitos de piel, Ganchitos
 Crochetes pour le peau, Crochetes
 Divaricatori per pelle, Divaricatori



78-030-16
O'Connor Skin Hook
 Sharp
 Overall Length 16 cm (6 1/4")



78-034-15
Joseph Mucus Hook
 Sharp
 Overall Length 15.5 cm (6")



78-036-16
Cottle Nasal Hook
 Sharp
 Overall Length 17 cm (6 3/4")



78-038-01
 Fig. 1

78-038-02
 Fig. 2

78-038-03
 Fig. 3

Cottle Nasal Hook
 Sharp
 Overall Length 14.5 cm (5 3/4")

Nerve Hooks
Nervhaken
Ganchos para nervios
Crochets à nerfs
Uncini per nervi



Cushing Nerve Hook
Blunt

78-040-01
Fig. 1
19 cm (7 1/2")

78-042-01
Fig. 1
28 cm (11")



78-040-02
Fig. 2
19.5 cm (7 3/4")

78-042-02
Fig. 2
28.5 cm (11")



Graefe Nerve Hook
Blunt
Overall Length 14 cm (5 1/2")



78-048-01
Fig. 1



78-048-02
Fig. 2



78-048-03
Fig. 3

Nerve Hooks
Nervhaken
Ganchos para nervios
Crochets à nerfs
Uncini per nervi



Crile Nerve Hook

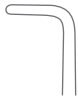

78-050-14
Angled 90°
Ø 1.4 mm
14.5 cm (5 ¾")



78-050-20
Angled 90°
Ø 1.4 mm
20 cm (8")



78-052-20
Angled 30°
Ø 1.4 mm
20.5 cm (8")



78-054-02
EIF Nerve & Vessel Hook
With Sharp Cutting Edge
Tip Size 2.0 mm
Overall Length 24 cm (9 ½")



78-056-25
Drake Nerve & Vessel Hook
Calibrated
Overall Length 25.5 cm (10")

Skin Hooks, Hooklets
 Hauthäkchen, Wundhäkchen
 Ganchitos de piel, Ganchitos
 Crochetes pour le peau, Crochetes
 Divaricatori per pelle, Divaricatori



Guthrie Skin Retractor
 Sharp
 Overall Length 15.5 cm (6")



78-060-01
 2.0 mm



78-060-02
 3.0 mm



78-062-13
Rollet Fine Wound Retractor
 2 Sharp Prongs, 4.5 mm
 Overall Length 13 cm (5")



Rollet Fine Wound Retractor
 Overall Length 13.5 cm (5 1/4")



78-064-01
 7.0 mm
 4 Sharp
 Prongs



78-064-02
 7.0 mm
 4 Blunt
 Prongs

Skin Hooks, Hooklets
 Hauthäkchen, Wundhäkchen
 Ganchitos de piel, Ganchitos
 Crochetes pour le peau, Crochetes
 Divaricatori per pelle, Divaricatori



78-066-13
4 Sharp Prongs



78-068-13
4 Blunt Prongs



78-070-01
9 mm



78-070-02
10 mm

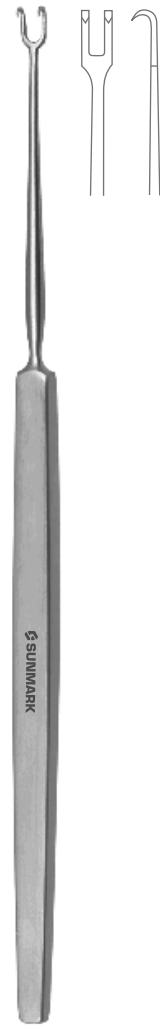

78-072-15
Freer Mucus Hook
Sharp, 3.2
Overall Length 15 cm (6")

Knapp Fine Wound Retractor
Overall Length 13.5 cm (5 1/4")

McIndoe Wound Retractor
2 Sharp Prongs

Skin Hooks, Hooklets
 Hauthäkchen, Wundhäkchen
 Ganchitos de piel, Ganchitos
 Crochetes pour le peau, Crochetes
 Divaricatori per pelle, Divaricatori



Joseph Mucus Hook
 Overall Length 16.5 cm (6 1/2")



78-074-02
 2.0 mm



78-074-05
 5.0 mm



78-074-07
 7.0 mm



78-074-10
 10.0 mm



78-076-10
Kilner Alar Hook
 Sharp
 Overall Length 8 cm (3 1/4")



78-078-12
Converse Alar Hook
 Sharp
 Overall Length 11.5 cm (4 1/2")

Hooklets
Wundhäkchen
Ganchitos
Crochetes
Divaricatori



78-080-14
Cottle Alar Hook
4 Semi Sharp Prongs
Overall Length 14 cm (5 ½")



78-082-05
Anderson Claw Retractor
5 Sharp Prongs
Overall Length 12 cm (4 ¾")



78-084-18
Tissue Picker
2 Twisted Sharp Prongs, Ø 1.8 mm
Overall Length 18.5 cm (7 ¼")

Hooklets
Wundhäkchen
Ganchitos
Crochetes
Divaricatori



Wound Retractor
Small Curved
Overall Length 16.5 cm (6 1/2")



Sharp Prongs

78-100-01

78-100-02

78-100-03

78-100-04

Blunt Prongs

78-101-01

78-101-02

78-101-03

78-101-04

Hooklets
Wundhäkchen
Ganchitos
Crochetes
Divaricatori



Wound Retractor
Flexible Prongs
Overall Length 16 cm (6 1/4")



78-104-02
Sharp



78-104-03
Sharp



78-104-04
Sharp



78-105-02
Blunt



78-105-03
Blunt



78-105-04
Blunt



Wound Retractor
Overall Length 16.5 cm (6 1/2")



78-108-01
Sharp



78-108-02
Blunt

Hooklets
Wundhäkchen
Ganchitos
Crochetes
Divaricatori



78-110-12
Moldestad Vessel Hook
Overall Length 12 cm (4 3/4")

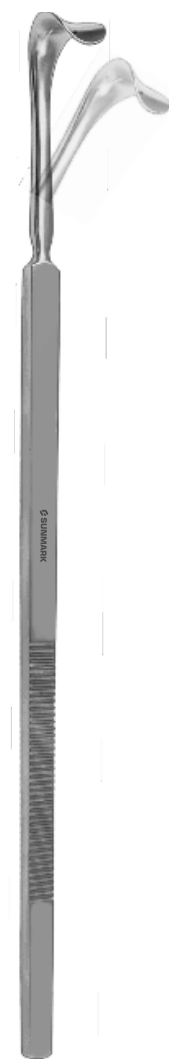

Kirclin Lid Retractor
Malleable
Overall Length 13 cm (5 1/4")



78-118-05
8 x 5 mm



78-118-07
9 x 7 mm



78-118-10
9 x 10 mm



78-118-12
9 x 12 mm



78-118-15
10 x 15 mm

Hooklets
Wundhäkchen
Ganchitos
Crochetes
Divaricatori

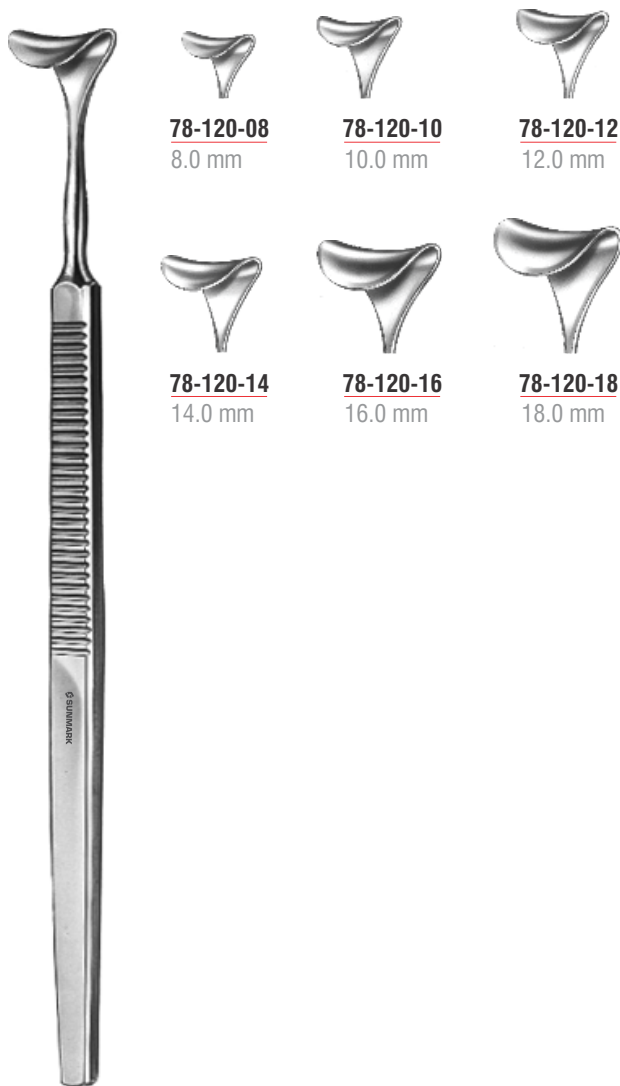

Desmarres Lid Retractor
Overall Length 16 cm (6 ¼")

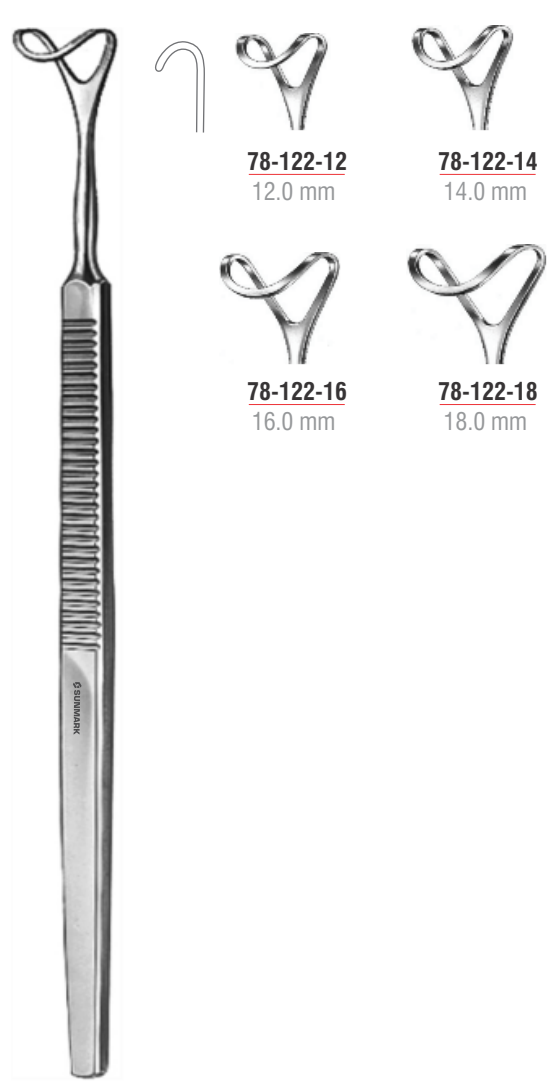

Lid Retractor
Hollow Blade
Overall Length 16 cm (6 ¼")

Hooklets
Wundhäkchen
Ganchitos
Crochetes
Divaricatori



78-124-14
Masing Lid Retractor
12.0 mm
Overall Length 14 cm (5 1/2")



Mini-Langenbeck Retractor
Overall Length 16 cm (6 1/4")



78-130-10
10 x 6 mm



78-130-17
17 x 5 mm



78-130-20
20 x 6 mm



78-130-22
22 x 8 mm

Hooklets
Wundhäkchen
Ganchitos
Crochetes
Divaricatori



78-132-16
16 x 6 mm

78-132-24
24 x 6 mm

Langenbeck-Green Retractor
Overall Length 16 cm (6 1/4")



78-134-16
Mannerfelt Modified Tendon Hook
Overall Length 16 cm (6 1/4")



78-136-16
Wound Retractor
Two Blunt Prongs
14 x 8 mm
Overall Length 16 cm (6 1/4")

Hooklets
Wundhäkchen
Ganchitos
Crochetes
Divaricatori



Wound Retractor
Large Curved
Overall Length 16.5 cm (6 1/2")



78-140-01
Sharp Prong



78-140-02
Sharp Prongs
7.5 mm



78-140-03
Sharp Prongs
10.0 mm

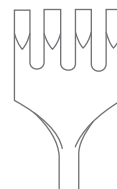

78-140-04
Sharp Prongs
14.0 mm



78-141-01
Sharp Blunt



78-141-02
Blunt Prongs
7.5 mm



78-141-03
Blunt Prongs
10.0 mm

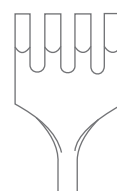

78-141-04
Blunt Prongs
14.0 mm

Hooklets
Wundhäkchen
Ganchitos
Crochetes
Divaricatori



Meyerding Retractor
Overall Length 17.5 cm (7")



78-150-01
Blunt
18 x 7 mm



78-150-02
Toothed
16 x 5 mm



78-150-03
Toothed
17 x 4 mm

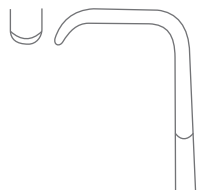

78-150-04
Blunt
10 x 3 mm

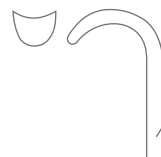

78-150-05
Saddle Shaped
7 x 4 mm

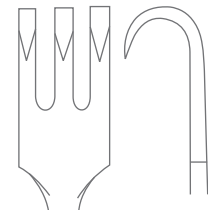

78-150-06
3 Sharp Prongs
10 x 4 mm

Hooklets
Wundhäkchen
Ganchitos
Crochetes
Divaricatori



Senn-Green Retractor
Overall Length 15 cm (6")



78-156-01
Fig. 1
20 x 6 mm



78-156-02
Fig. 2
10 x 6 mm



78-158-14
Ragnell-Davis Retractor
8 x 4 mm - 15 x 5.5 mm
Overall Length 14 cm (5 1/2")

Hooklets
Wundhäkchen
Ganchitos
Crochetes
Divaricatori



78-160-16
Kilner Retractor
Sharp, 13 x 5 mm
Overall Length 16 cm (6 1/2")



Senn-Miller Retractor
Overall Length 16 cm (6 1/2")

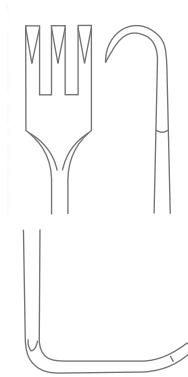

78-162-16
Sharp
20 x 7 mm

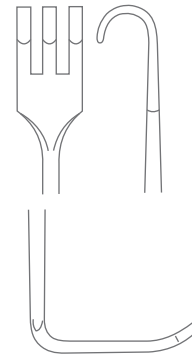

78-163-16
Blunt
20 x 7 mm

Hooklets
Wundhäkchen
Ganchitos
Crochetes
Divaricatori



78-170-20
Cushing Retractor/Saddle Hook
Overall Length 20.5 cm (8")

Saddle Hooks
 Sattelhäkchen
 Ganchos en forma de silla
 Ecarteurs sous forme de selle
 Divaricatori a forma di sella



78-172-08
8.0 mm



78-172-10
10.0 mm



78-172-12
12.0 mm



78-172-14
14 mm



78-172-16
16 mm



78-172-18
18 mm

Cushing Retractor/Saddle Hook
Overall Length 20.5 cm (8")



78-174-08
8.0 mm



78-174-10
10.0 mm



78-174-12
12.0 mm



78-174-14
14 mm



78-174-16
16 mm



78-174-18
18 mm

Cushing Retractor/Saddle Hook
Overall Length 24 cm (9 1/2")

Saddle Hooks, Vein Hooks
 Sattelhäkchen, Venenhäkchen, Wundhäkchen
 Ganchos en forma de silla, Ganchitos para venas
 Ecarteurs sous forme de selle, Ecarteurs pour veines
 Divaricatori a forma di sella, Divaricatori per venia



Gil-Vernet Retractor/Saddle Hook
 Overall Length 24 cm (9 1/2")



78-176-08
 8.0 mm



78-176-11
 11.0 mm



78-176-15
 15.0 mm



78-176-17
 17.0 mm



78-176-20
 20.0 mm



78-176-23
 23.0 mm



Brom Vein Hook
 Overall Length 19.5 cm (7 3/4")



78-178-01



78-178-02

Vein Hooks
Wundhäkchen
Ganchitos para venas
Ecarteurs pour veines
Divaricatori per venia



Strandell-Stille Retractor
Overall Length 19 cm (7 3/4")



78-184-08
Kaye-Millard Retractor
Sharp
Overall Length 8 cm (3")



Klapp Retractor
Blunt
Overall Length 17.5 cm (7")

Retractors
Wundhaken, Wundhäkchen
Separadores
Ecarteurs
Divaricatori



Volkmann Retractor
Hollow Handle
Overall Length 21.5 cm (8 1/2")

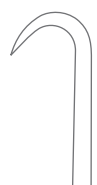

78-200-01
Sharp
1 Prong



78-200-02
Sharp
2 Prongs



78-200-03
Sharp
3 Prongs



78-200-04
Sharp
4 Prongs

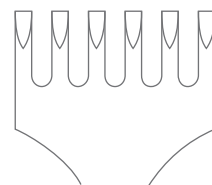

78-200-06
Sharp
6 Prongs

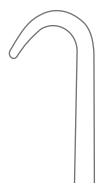

78-201-01
Blunt
1 Prong



78-201-02
Blunt
2 Prongs



78-201-03
Blunt
3 Prongs

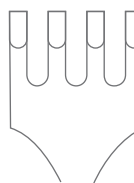

78-201-04
Blunt
4 Prongs

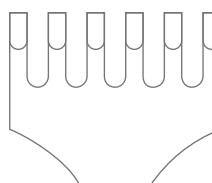













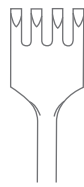
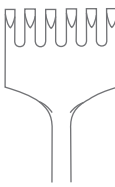

78-201-06
Blunt
6 Prongs

Retractors
Wundhaken, Wundhäkchen
Separadores
Ecarteurs
Divaricatori

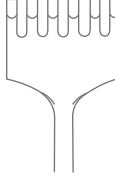
RETRACTORS

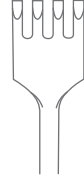
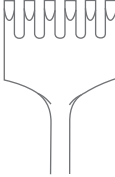

					
Sharp	78-210-01 1 Prong	78-210-02 2 Prongs	78-210-03 3 Prongs	78-210-04 4 Prongs	78-210-06 6 Prongs
					
Blunt	78-211-01 1 Prong	78-211-02 2 Prongs	78-211-03 3 Prongs	78-211-04 4 Prongs	78-211-06 6 Prongs
					
Semi Sharp	78-212-01 1 Prong	78-212-02 2 Prongs	78-212-03 3 Prongs	78-212-04 4 Prongs	78-212-06 6 Prongs

Volkman Retractor
Overall Length 22 cm (8 3/4")

Retractors
Wundhaken, Wundhäkchen
Separadores
Ecarteurs
Divaricatori



78-214-01
Volkman Retractor
Sharp, 1 Prong
Overall Length 21.5 cm (8 1/2")



78-215-01
Volkman Retractor
Blunt, 1 Prong
Overall Length 21.5 cm (8 1/2")



78-218-01
Volkman Retractor
Sharp, 1 Prong
Overall Length 21.5 cm (8 1/2")

Retractors
Wundhaken, Wundhäkchen
Separadores
Ecarteurs
Divaricatori

RETRACTORS



Kocher Retractor
Overall Length 22 cm (8 3/4")

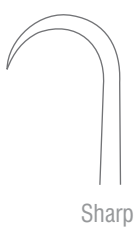

78-220-01
1 Prong

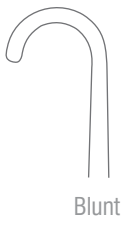
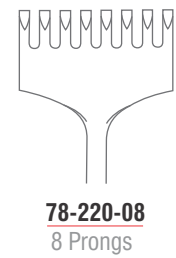
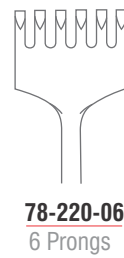
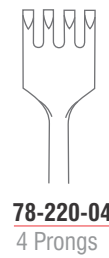
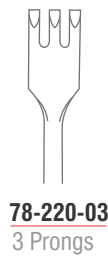

78-221-01
1 Prong

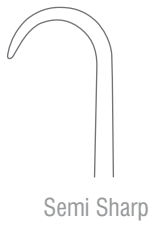
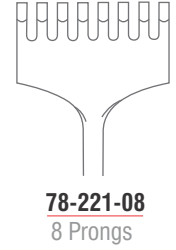
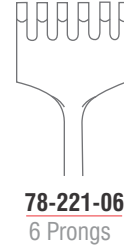
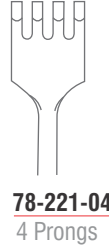
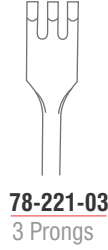
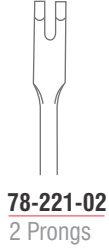

78-222-01
1 Prong

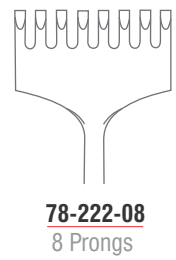
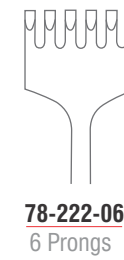
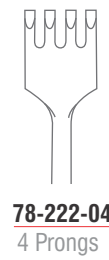
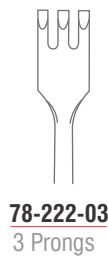

Retractors
Wundhaken, Wundhäkchen
Separadores
Ecarteurs
Divaricatori



Murphy Retractor
Overall Length 19.5 cm (7 ¾")



78-224-03
Sharp
3 Prongs



78-224-04
Sharp
4 Prongs



78-225-03
Blunt
3 Prongs



78-225-04
Blunt
4 Prongs



78-226-27
Lambotte Bone Hook
Overall Length 27 cm (10 ½")

Retractors
Wundhaken, Wundhäkchen
Separadores
Ecarteurs
Divaricatori

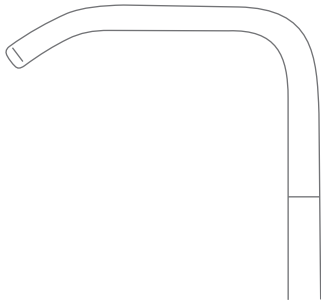

78-231-03
Blunt
36 x 30 mm
3 Prongs

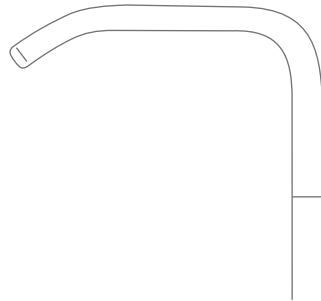

78-231-04
Blunt
36 x 60 mm
4 Prongs

Ollier Retractor
Overall Length 23 cm (9")

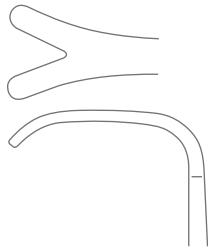

78-235-02
Wassmund Retractor
33 x 21 mm
Overall Length 20.5 cm (8")

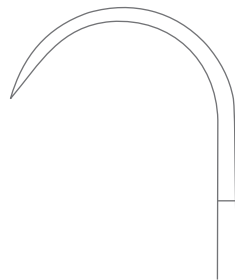

78-238-08
Sharp, 8 Prongs
40 x 30 mm

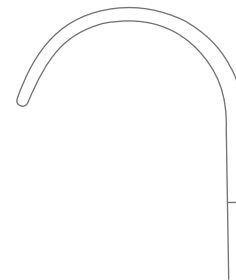

78-239-08
Blunt, 8 Prongs
40 x 30 mm

Koerte Retractor
Overall Length 24.5 cm (9 3/4")

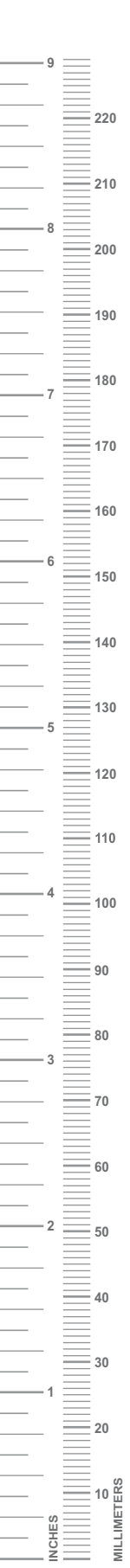

Retractors
Wundhaken, Wundhäkchen
Separadores
Ecarteurs
Divaricatori



Israel Retractor
Overall Length 25.5 cm (10")



78-241-04
Blunt, 4 Prongs
40 x 40 mm

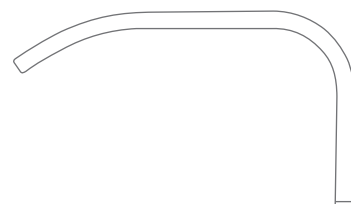

78-243-05
Blunt, 5 Prongs
45 x 50 mm

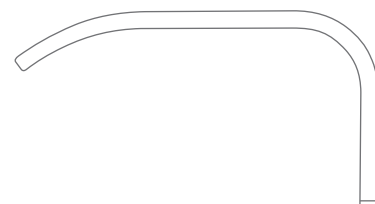

78-245-06
Blunt, 6 Prongs
50 x 60 mm

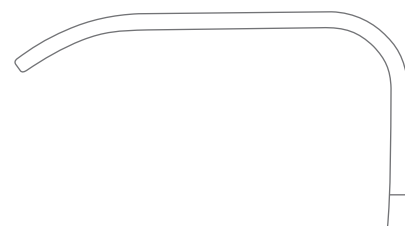

78-247-07
Blunt, 7 Prongs
70 x 70 mm

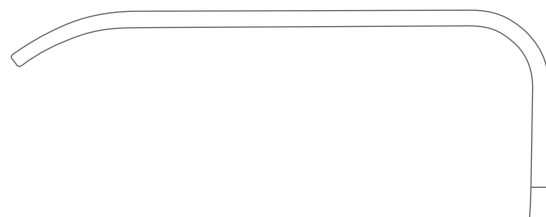

Retractors
Wundhaken, Wundhäkchen
Separadores
Ecarteurs
Divaricatori



Langenbeck Retractor
Overall Length 22.5 cm (8 3/4")

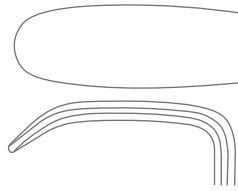

78-251-01
30 x 11

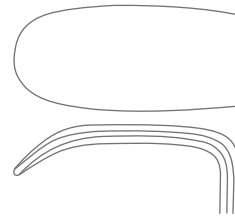

78-251-02
30 x 14

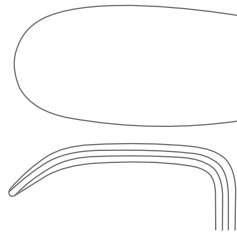

78-251-03
30 x 16

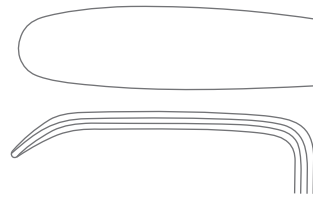

78-251-04
40 x 11

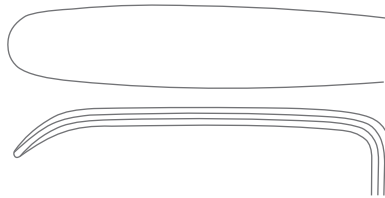

78-251-05
50 x 11

Retractors
Wundhaken, Wundhäkchen
Separadores
Ecarteurs
Divaricatori



Langenbeck Retractor
Hollow Handle
Overall Length 22.5 cm (8 ¾")

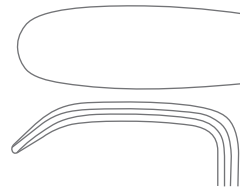

78-253-01
30 x 11

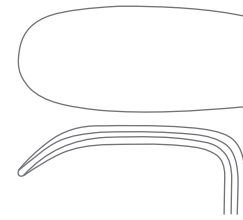

78-253-02
30 x 14

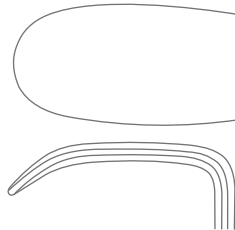

78-253-03
30 x 16

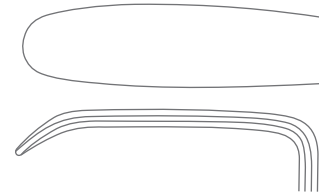

78-253-04
40 x 11

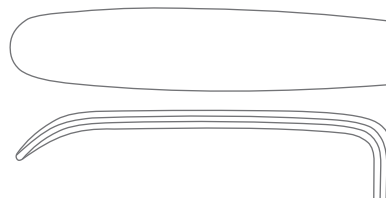

78-253-05
50 x 11

Retractors
Wundhaken, Wundhäkchen
Separadores
Ecarteurs
Divaricatori

78

RETRACTORS



78-255-00
Langenbeck Retractor
33 x 14
Overall Length 22.5 cm (8 ¾")



Langenbeck Retractor
Overall Length 21 cm (8 ¼")



78-257-01
55 x 20 mm

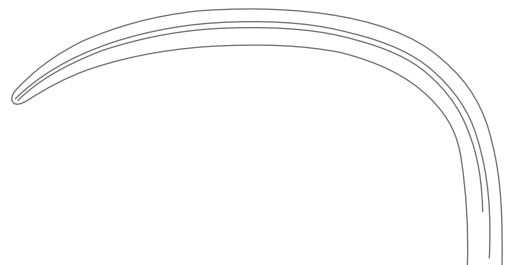

78-257-02
60 x 20 mm



78-257-03
63 x 20 mm

Retractors
Wundhaken, Wundhäkchen
Separadores
Ecarteurs
Divaricatori

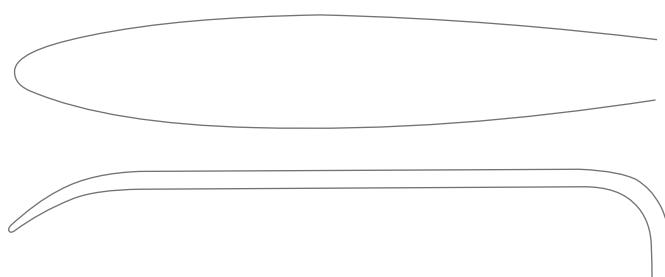

78-259-22
Langenbeck Retractor
85 x 15 mm
Overall Length 22.5 cm (8 ¾")

Retractors
Wundhaken, Wundhäkchen
Separadores
Ecarteurs
Divaricatori

78

RETRACTORS



78-271-19
Lahey Retractor
31 x 6 mm
Overall Length 19.5 cm (7 ¾")



78-275-20
Little Retractor
13 x 15 mm
Overall Length 20 cm (8")

Retractors
Wundhaken, Wundhäkchen
Separadores
Ecarteurs
Divaricatori



Kocher Retractor
Overall Length 23 cm (9")

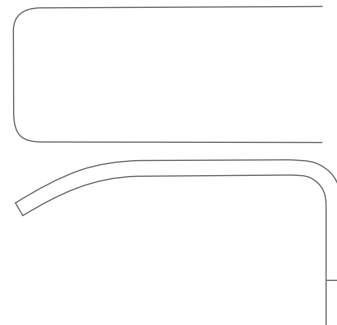

78-281-18
41 x 18 mm



78-281-20
61 x 20 mm

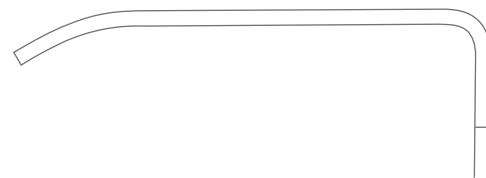

78-281-25
61 x 25 mm

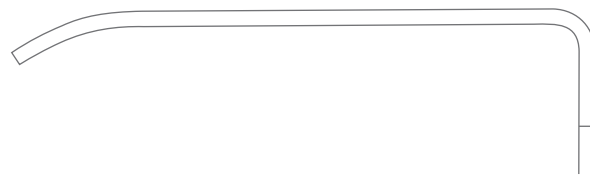

78-281-30
75 x 30 mm

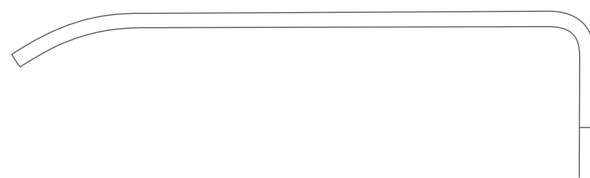

78-281-40
75 x 40 mm



Retractors
Wundhaken, Wundhäkchen
Separadores
Ecarteurs
Divaricatori

78

RETRACTORS



Kocher-Langenbeck Retractor
Overall Length 21.5 cm (8 1/2")

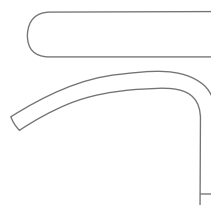

78-291-01
25 x 6 mm

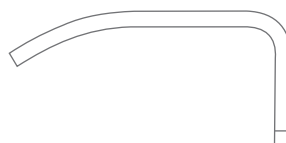

78-291-02
35 x 8 mm

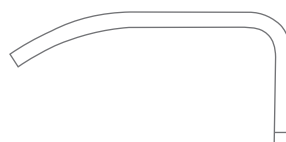

78-291-03
35 x 11 mm

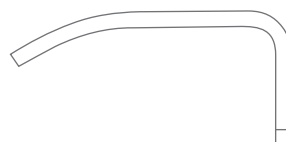

78-291-04
35 x 15 mm

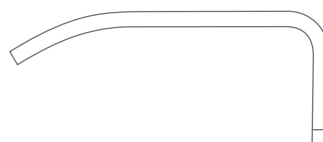

78-291-05
40 x 11 mm



78-291-06
55 x 11 mm



78-291-07
70 x 14 mm

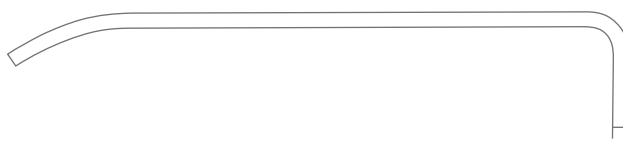

78-291-08
80 x 12 mm



78-291-09
80 x 16 mm



Retractors
Wundhaken, Wundhäkchen
Separadores
Ecarteurs
Divaricatori



Kocher-Langenbeck Retractor
Overall Length 21.5 cm (8 1/2")

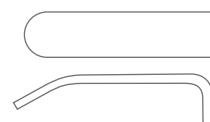

78-293-01
25 x 10 mm



78-293-02
40 x 13 mm



78-293-03
60 x 13 mm



78-293-04
40 x 18 mm

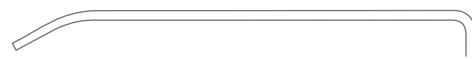

78-293-05
60 x 18 mm



78-293-06
85 x 18 mm



78-293-07
60 x 25 mm



78-293-08
85 x 25 mm

Retractors
Wundhaken, Wundhäkchen
Separadores
Ecarteurs
Divaricatori

78

RETRACTORS



78-295-01
45 x 15 mm



78-295-02
60 x 23 mm

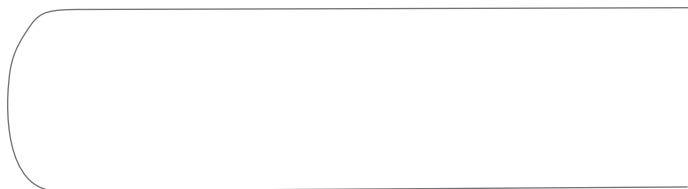

78-295-02
72 x 20 mm

Sauerbruch Retractor
Overall Length 22.5 cm (8 3/4")





Retractors
Wundhaken, Wundhäkchen
Separadores
Ecarteurs
Divaricatori



Kirsch Retractor
Overall Length 21 cm (8 1/4")

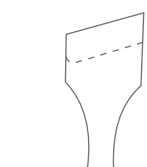

78-297-01
Left
60 x 11 mm



78-297-02
Right
60 x 11 mm

Retractors
Wundhaken, Wundhäkchen
Separadores
Ecarteurs
Divaricatori

78

RETRACTORS



Zenker Retractor

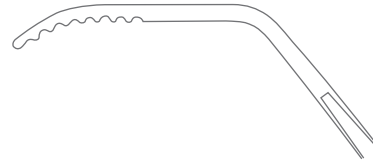

78-301-01
35 x 8 mm
25 cm (9 3/4")

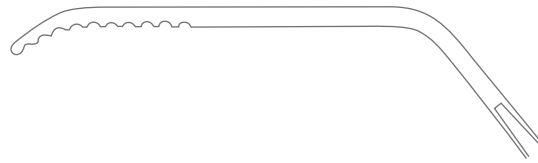

78-301-02
60 x 12 mm
26.5 cm (10 1/2")

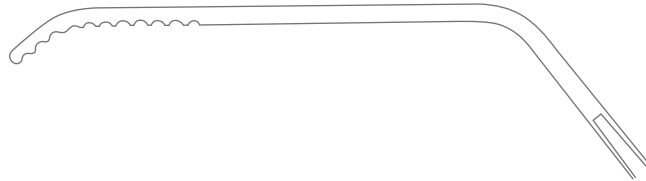

78-301-03
75 x 12 mm
27.5 cm (10 3/4")

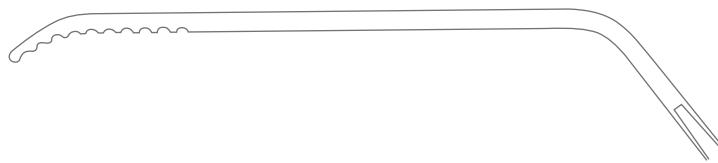

78-301-04
85 x 20 mm
28.5 cm (11 1/4")

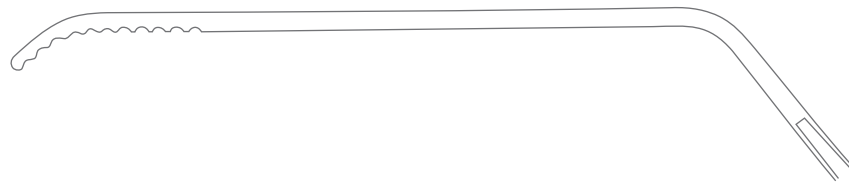

78-301-05
100 x 25 mm
30.5 cm (12")



Retractors
Wundhaken, Wundhäkchen
Separadores
Ecarteurs
Divaricatori



Cloward Retractor
Overall Length 18.5 cm (7 1/4")

78-303-18
18 mm

78-303-20
20 mm

78-303-23
23 mm



Koenig Retractor
Overall Length 18 cm (7")



78-305-01
13 x 13 mm



78-305-02
12 x 16 mm

Retractors
Wundhaken, Wundhäkchen
Separadores
Ecarteurs
Divaricatori

RETRACTORS



78-305-17
Cushing-Kocher Retractor
10 x 10 mm
Overall Length 17.5 cm (7")



Kocher Retractor
Overall Length 21.5 cm (8 1/2")

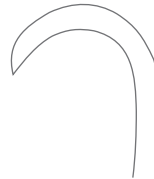

78-321-01
22 x 12 mm



78-321-02
24 x 14 mm

Retractors
Wundhaken, Wundhäkchen
Separadores
Ecarteurs
Divaricatori



Kocher Retractor
Overall Length 22 cm (8 1/2")

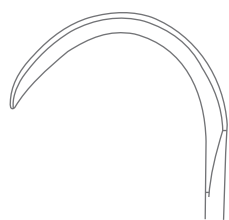

78-331-01
42 x 10 mm



78-331-02
42 x 15 mm

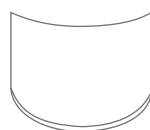

78-331-03
43 x 20 mm



78-335-20
Schoenborn Retractor
13 x 6 mm
Overall Length 20 cm (8")



78-337-20
Wound Retractor
Double Ended, 20 x 19 mm
Overall Length 20.5 cm (8")

Retractors
Wundhaken, Wundhäkchen
Separadores
Ecarteurs
Divaricatori

78

RETRACTORS



78-341-23
Dissecting Hook
For Longitudinal
Dissection of Vessels
Overall Length 23.5 cm (9 1/2")



78-351-21
Durham Retractor
16 x 25 mm
Overall Length 21.5 cm (8 1/2")



Middeldorf Retractor

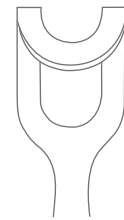
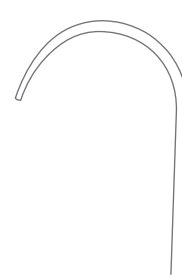

78-353-01
15 x 17 mm
21.5 cm (8 1/2")

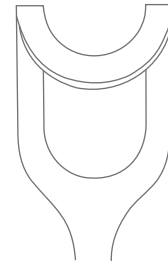

78-353-02
22 x 22 mm
23 cm (9")

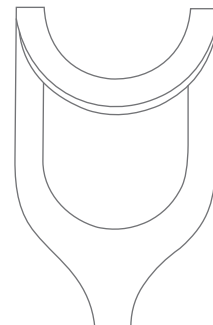

78-353-03
26 x 31 mm
24.5 cm (9 3/4")

Retractors
Wundhaken, Wundhäkchen
Separadores
Ecarteurs
Divaricatori



Mideeldorf Retractor

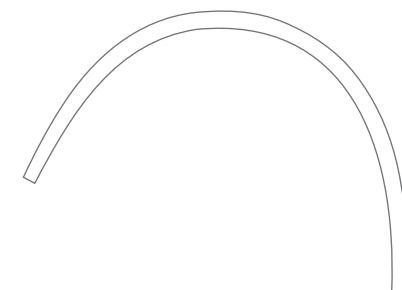

78-355-01
48 x 45 mm
27 cm (10 3/4")

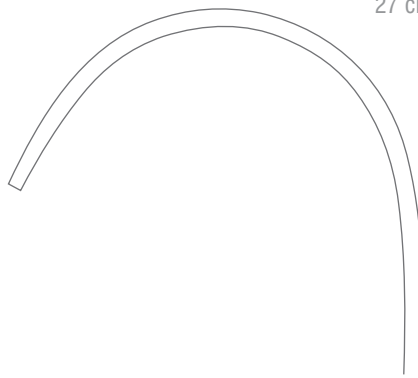

78-355-02
52 x 50 mm
27 cm (10 3/4")

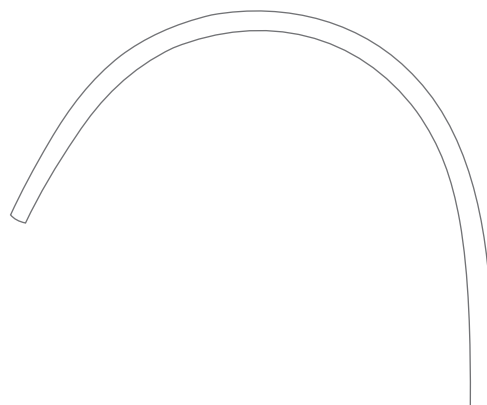

78-355-03
60 x 70 mm
28 cm (11")

Retractors
Wundhaken, Wundhäkchen
Separadores
Ecarteurs
Divaricatori

78

RETRACTORS

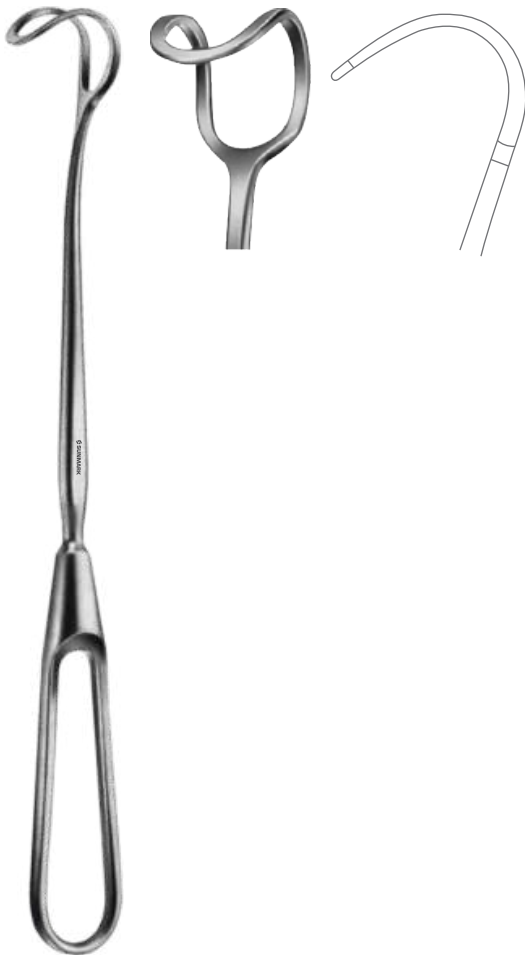

78-357-22
Greene Retractor
22 x 22 mm
Overall Length 22.5 cm (8 3/4")



78-361-20
Buchs Retractor
38 x 18 mm
Overall Length 20.5 cm (8")

Retractors
Wundhaken, Wundhäkchen
Separadores
Ecarteurs
Divaricatori



78-363-21
Kraemer Retractor
66 x 10 mm
Overall Length 21 cm (8 1/4")



78-365-21
Caspar Retractor
67 x 17 mm
Overall Length 21 cm (8 1/4")



Dockhorn Retractor
Overall Length 21 cm (8 1/4")



78-367-01
40 x 12 mm



78-367-02
55 x 14 mm

Retractors
Wundhaken, Wundhäkchen
Separadores
Ecarteurs
Divaricatori

RETRACTORS



78-369-18
Cloward Old Style Retractor
18 mm
Overall Length 18 cm (7")

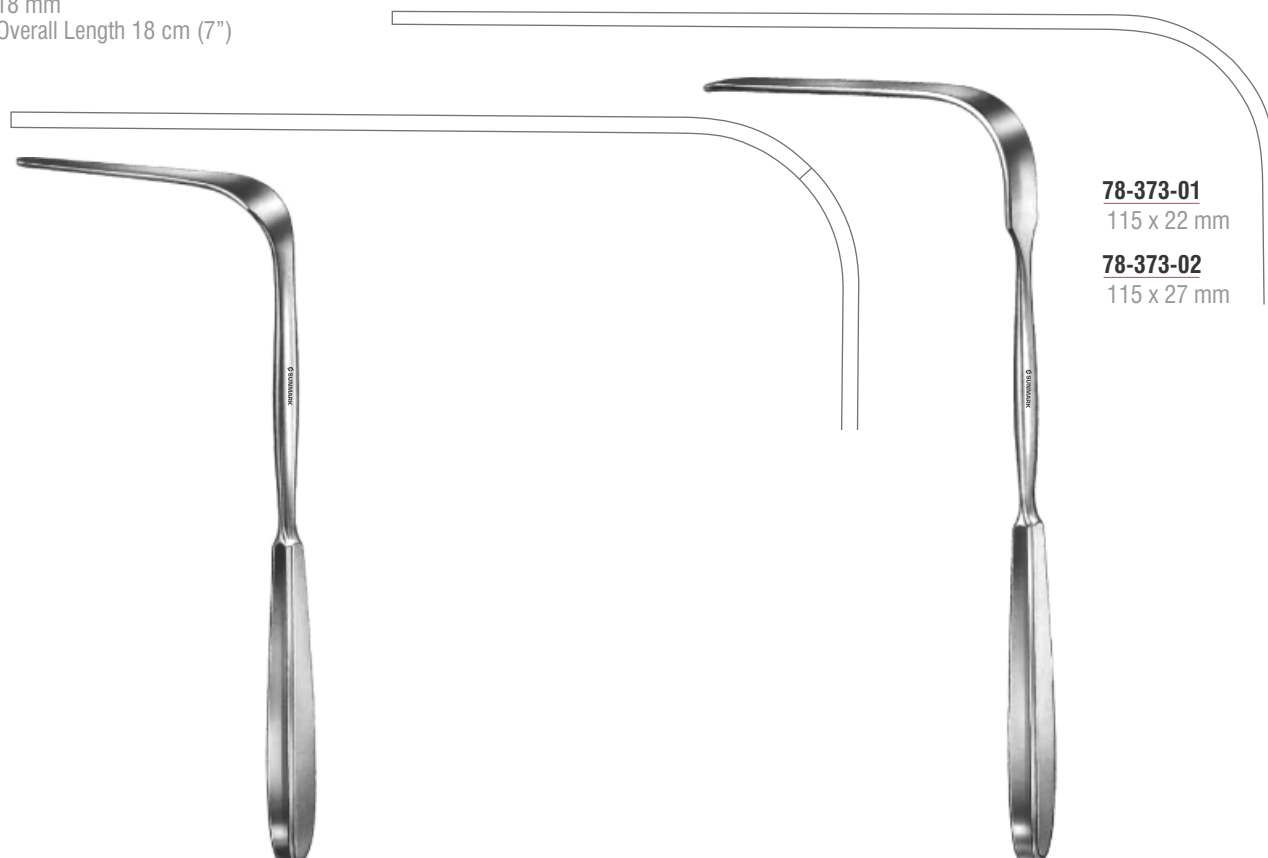

78-371-25
Martin Retractor
110 x 27 mm
Overall Length 26 cm (10 1/4")

Simon Retractor
Overall Length 28 cm (11")

78-373-01
115 x 22 mm
78-373-02
115 x 27 mm



Retractors
Wundhaken, Wundhäkchen
Separadores
Ecarteurs
Divaricatori



78-375-18
164 x 30 mm



78-375-16
160 x 30 mm



78-375-14
144 x 30 mm



78-375-13
130 x 30 mm



78-375-12
124 x 30 mm



78-375-10
104 x 25 mm

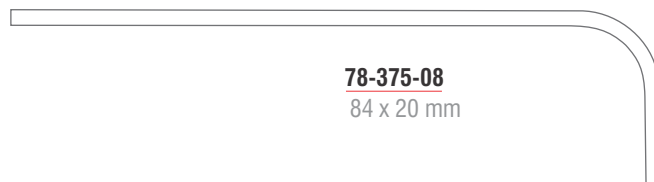

78-375-08
84 x 20 mm



Brunner Retractor
Overall Length 25.5 cm (10")

Retractors
 Wundhaken, Wundhäkchen
 Separadores
 Ecarteurs
 Divaricatori

RETRACTORS



78-377-18
 182 x 30 mm

78-377-16
 162 x 30 mm

78-377-14
 140 x 25 mm

78-377-12
 122 x 30 mm

78-377-10
 102 x 20 mm

78-377-08
 82 x 20 mm

Brunner Retractor
 Overall Length 25.5 cm (10")



Retractors
Wundhaken, Wundhäkchen
Separadores
Ecarteurs
Divaricatori



Coryllos Retractor
Overall Length 24 cm (9 1/2")



78-381-03
119 x 65 mm

78-381-02
108 x 43 mm

78-381-01
85 x 22 mm

Retractors
Wundhaken, Wundhäkchen
Separadores
Ecarteurs
Divaricatori

78

RETRACTORS



Davidson Scapula Retractor

78-385-01
80 x 45 mm
19 cm (7 ½")

78-385-02
80 x 95 mm
18.5 cm (7 ¼")



78-387-25
Sauerbruch Retractor
127 x 38 mm
Overall Length 25.5 cm (10")



Richardson-Eastman Retractor

78-400-00
Set of Fig. 1 & Fig. 2

78-400-01
Fig. 1
28 x 20 mm-36 x 28 mm

78-400-02
Fig. 2
49 x 38 mm-63 x 49 mm



Retractors
Wundhaken, Wundhäkchen
Separadores
Ecarteurs
Divaricatori



Richardson Retractor

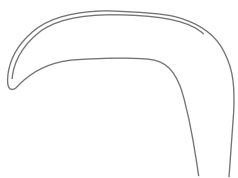

78-403-01
25 x 21 mm
23.5 cm (9 1/4")

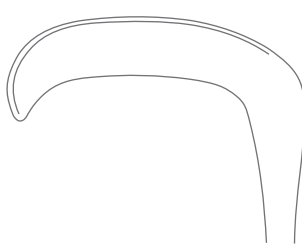

78-403-02
30 x 29 mm
24 cm (9 1/2")

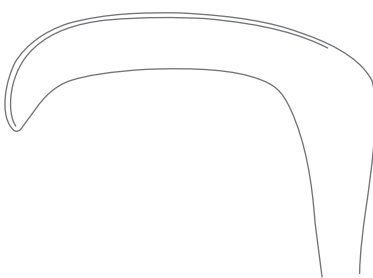

78-403-03
30 x 29 mm
24 cm (9 1/2")



78-405-24
Richardson Retractor
48 x 22 mm
Overall Length 24 cm (9 1/2")

Retractors
Wundhaken, Wundhäkchen
Separadores
Ecarteurs
Divaricatori

78

RETRACTORS



Kelly Retractor
Overall Length 26 cm (10 1/4")

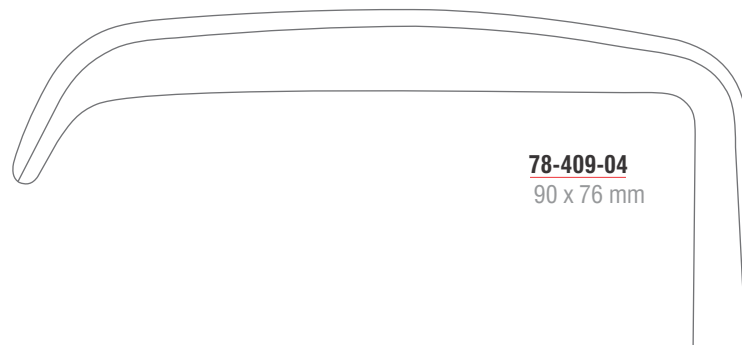
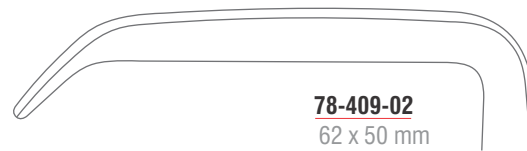
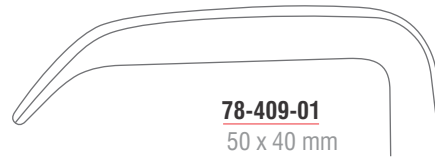

Retractors
Wundhaken, Wundhäkchen
Separadores
Ecarteurs
Divaricatori

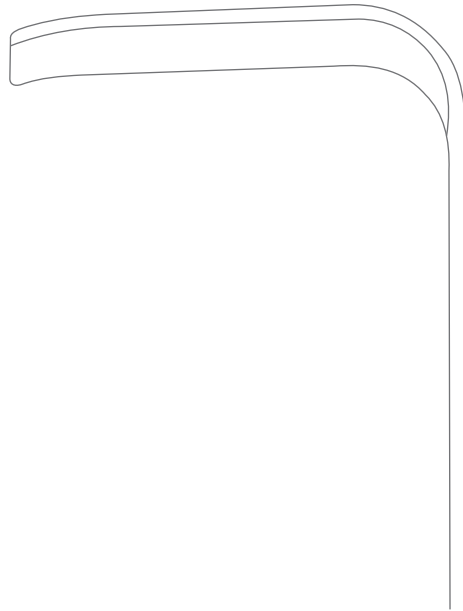

78-413-21
Tuffier Retractor
58 x 64 mm
Overall Length 21.5 cm (8 ½")



Morris Retractor
Overall Length 24.5 cm (9 ¾")

78-415-01
70 x 40 mm

78-415-02
70 x 50 mm

78-415-03
70 x 65 mm

Retractors
Wundhaken, Wundhäkchen
Separadores
Ecarteurs
Divaricatori

78

RETRACTORS



78-416-01
32 x 51 mm, 38 x 51 mm

78-416-02
44 x 51 mm, 51 x 51 mm

78-416-03
64 x 51 mm, 38 x 51 mm

Morris Retractor
Double Ended
Overall Length 21.5 cm (8 1/2")

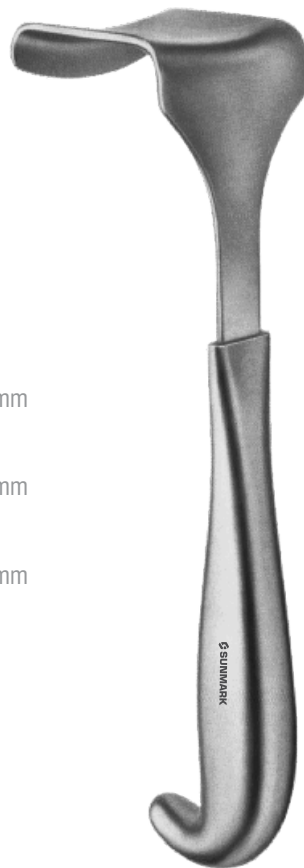

78-417-20
Tudor-Edwards Retractor
55 x 47 mm
Overall Length 20.5 cm (8")

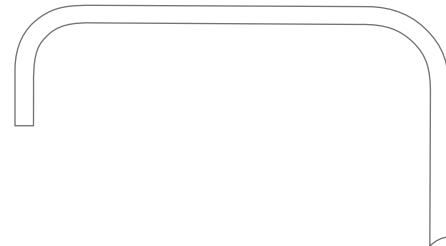

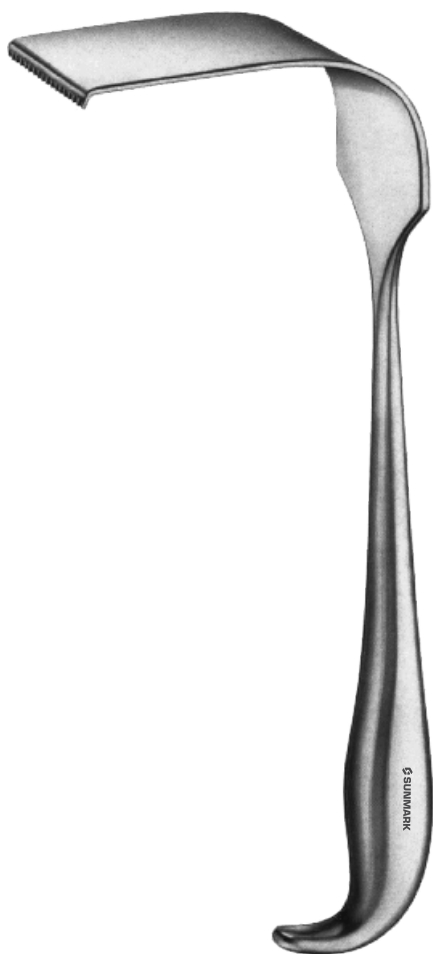
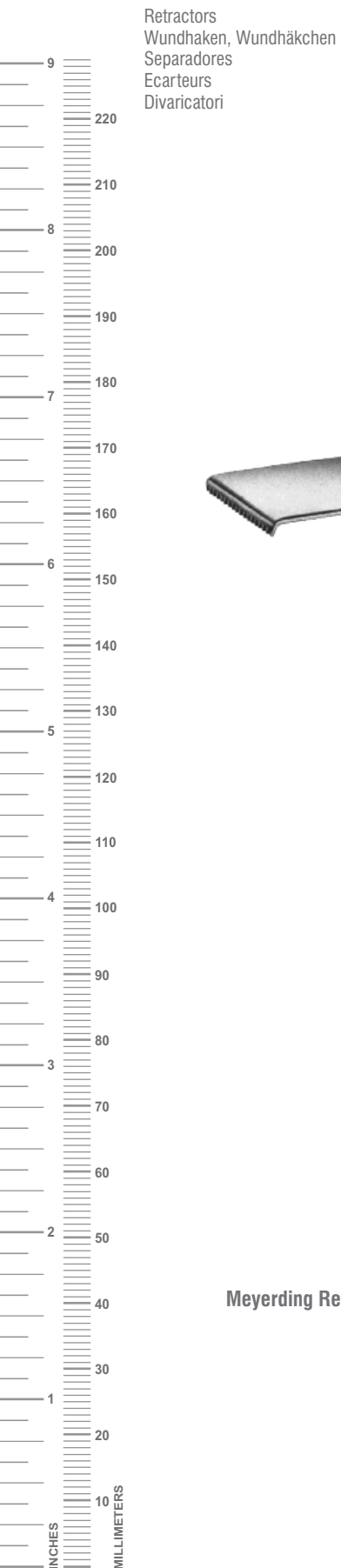

Meyerding Retractor



78-419-01
52 x 16 mm
23 cm (9")



78-419-02
76 x 25 mm
23 cm (9")

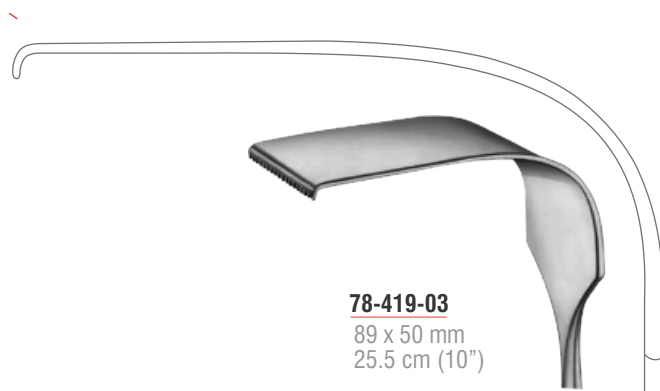

78-419-03
89 x 50 mm
25.5 cm (10")

Retractors
Wundhaken, Wundhäkchen
Separadores
Ecarteurs
Divaricatori

78

RETRACTORS

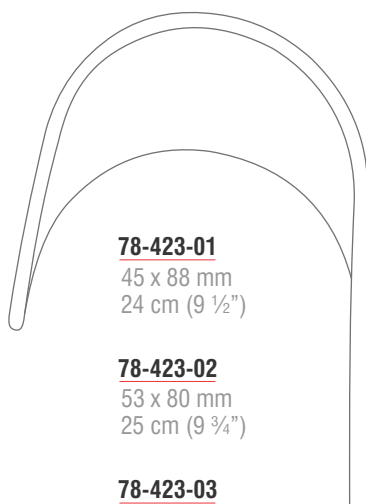

78-423-01
45 x 88 mm
24 cm (9 1/2")

78-423-02
53 x 80 mm
25 cm (9 3/4")

78-423-03
78 x 82 mm
25 cm (9 3/4")

Doyen Retractor



78-431-01
48 x 90 mm

78-431-02
48 x 105 mm

78-431-03
48 x 120 mm

78-431-04
48 x 135 mm

Doyen Retractor
Overall Length 28 cm (11")



645 Grams

78-431-10
Chain With Weight
For use with 78-431-01 to 78-431-04
Overall Length 79 cm (31")





Retractors
Wundhaken, Wundhäkchen
Separadores
Ecarteurs
Divaricatori



78-435-22
Kocher Retractor
73 x 25 mm
Overall Length 24 cm (9 1/2")



78-437-01
80 x 45 mm

78-437-02
80 x 55 mm

78-437-03
80 x 65 mm

Kocher Retractor
Overall Length 25 cm (9 3/4")

Retractors
Wundhaken, Wundhäkchen
Separadores
Ecarteurs
Divaricatori

78

RETRACTORS



Doyen-Stille Retractor
Overall Length 26 cm (10 1/4")



78-441-01
87 x 28 mm

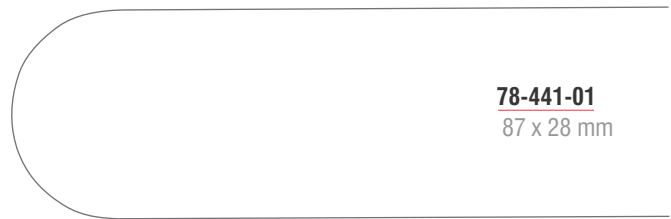

78-441-02
97 x 31 mm

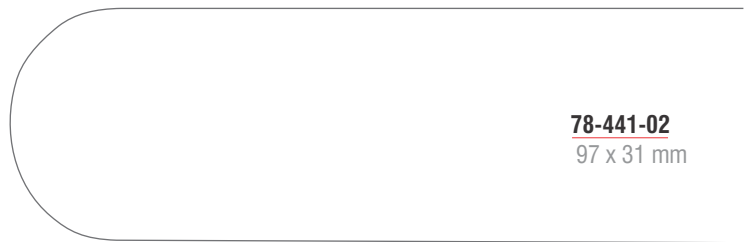

78-441-03
117 x 52 mm

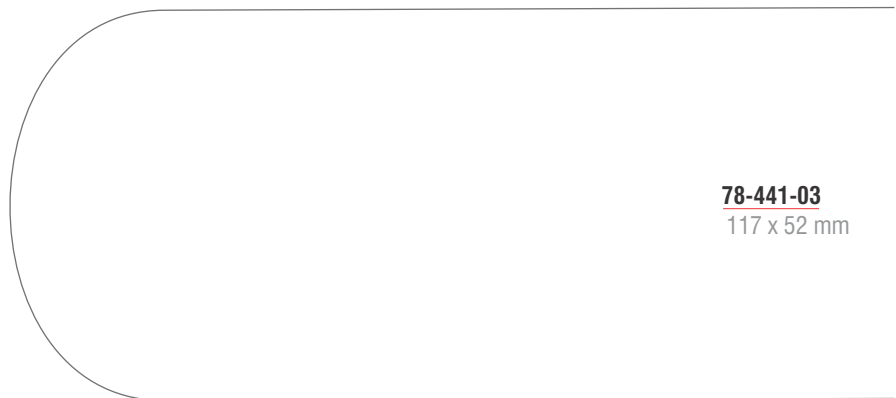

Retractors
Wundhaken, Wundhäkchen
Separadores
Ecarteurs
Divaricatori



Fritsch Retractor

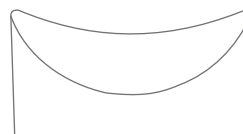

78-445-01
37 x 31 mm
23.5 cm (9 1/4")



78-445-02
38 x 40 mm
24 cm (9 1/2")



78-445-03
43 x 51 mm
25 cm (9 3/4")

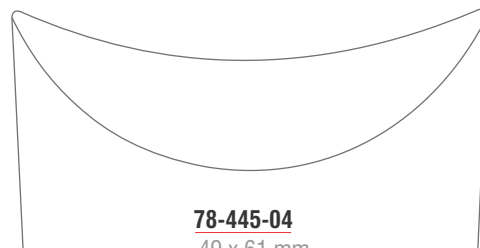

78-445-04
49 x 61 mm
25 cm (9 3/4")

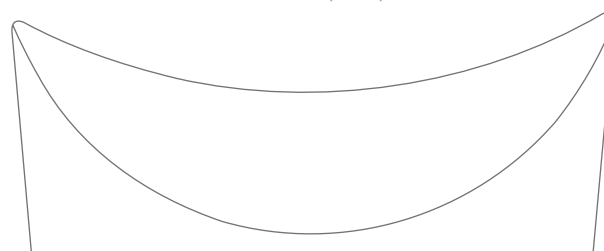

78-445-05
48 x 75 mm
25.5 cm (10")

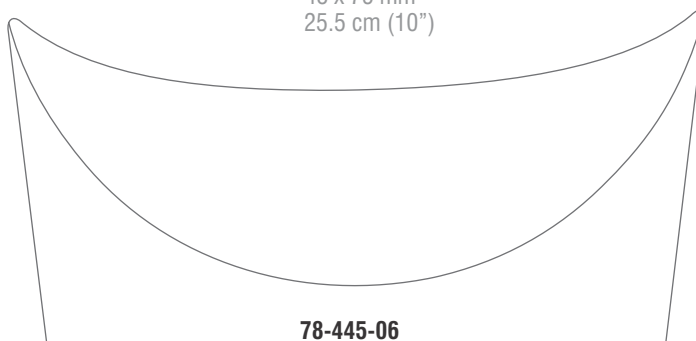

78-445-06
65 x 85 mm
26.5 cm (10 1/2")

Retractors
Wundhaken, Wundhäkchen
Separadores
Ecarteurs
Divaricatori

78

RETRACTORS



Hoesel Retractor
Overall Length 26 cm (10 1/4")

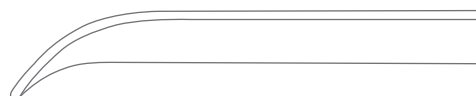

78-449-01
63 x 21 mm



78-449-02
83 x 30 mm

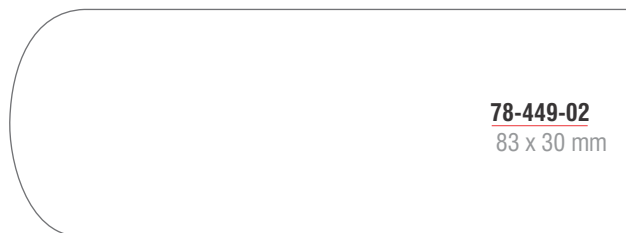

78-449-03
103 x 30 mm



78-449-04
120 x 30 mm



78-449-05
140 x 30 mm



78-449-06
140 x 40 mm

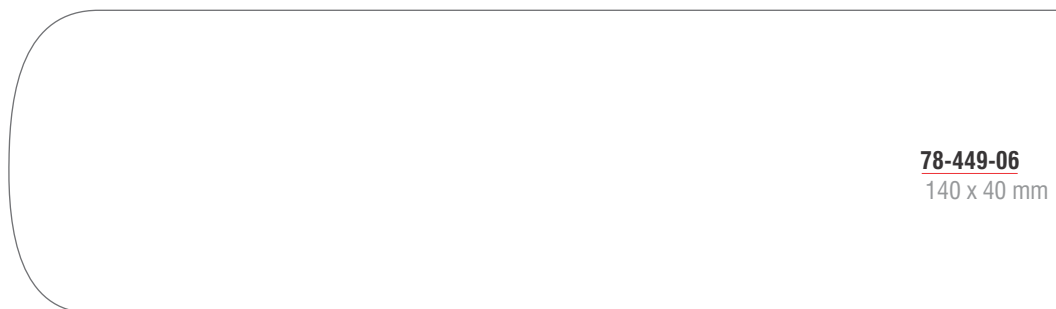

Retractors
Wundhaken, Wundhäkchen
Separadores
Ecarteurs
Divaricatori

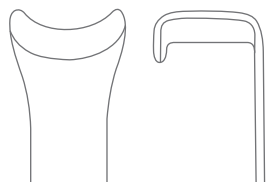

78-455-01
Fig. 1
16 x 15 mm



78-455-02
Fig. 2
23 x 13 mm



78-455-03
Fig. 3
24 x 16 mm

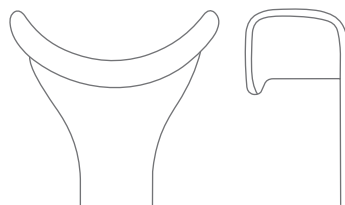

78-455-04
Fig. 4
27 x 13 mm

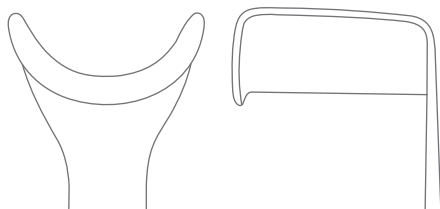

78-455-05
Fig. 5
27 x 27 mm

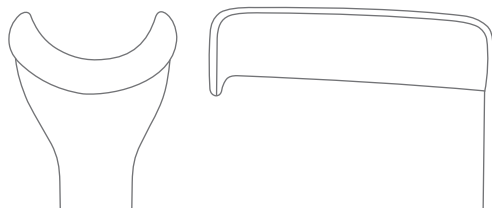

78-455-06
Fig. 6
25 x 39 mm



Ross Aorta Retractor
Flexible Shaft
Overall Length 25.5 cm (10")



78-457-06
6.0 mm
78-457-08
8.0 mm
78-457-11
11.0 mm
Cleland Valve Leaflet Retractor
Overall Length 26 cm (10 1/4")

Retractors
Wundhaken, Wundhäkchen
Separadores
Ecarteurs
Divaricatori

78

RETRACTORS

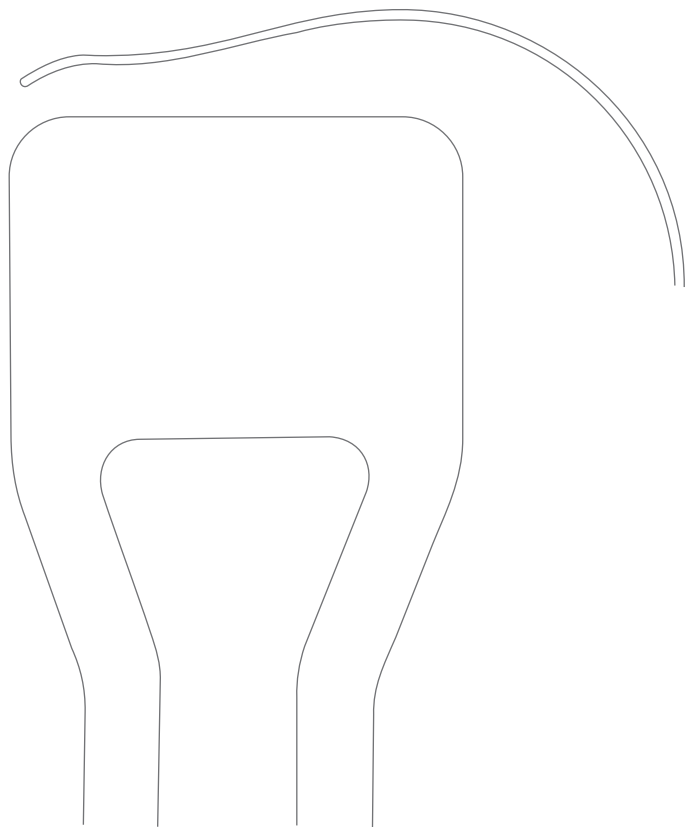

78-461-27
Polloson Retractor
Overall Length 25.5 cm (10")

Retractors
Wundhaken, Wundhäkchen
Separadores
Ecarteurs
Divaricatori



78-463-24
Harrington-Baby Retractor
70 x 24 mm
Overall Length 25.5 cm (10")



Retractors
Wundhaken, Wundhäkchen
Separadores
Ecarteurs
Divaricatori

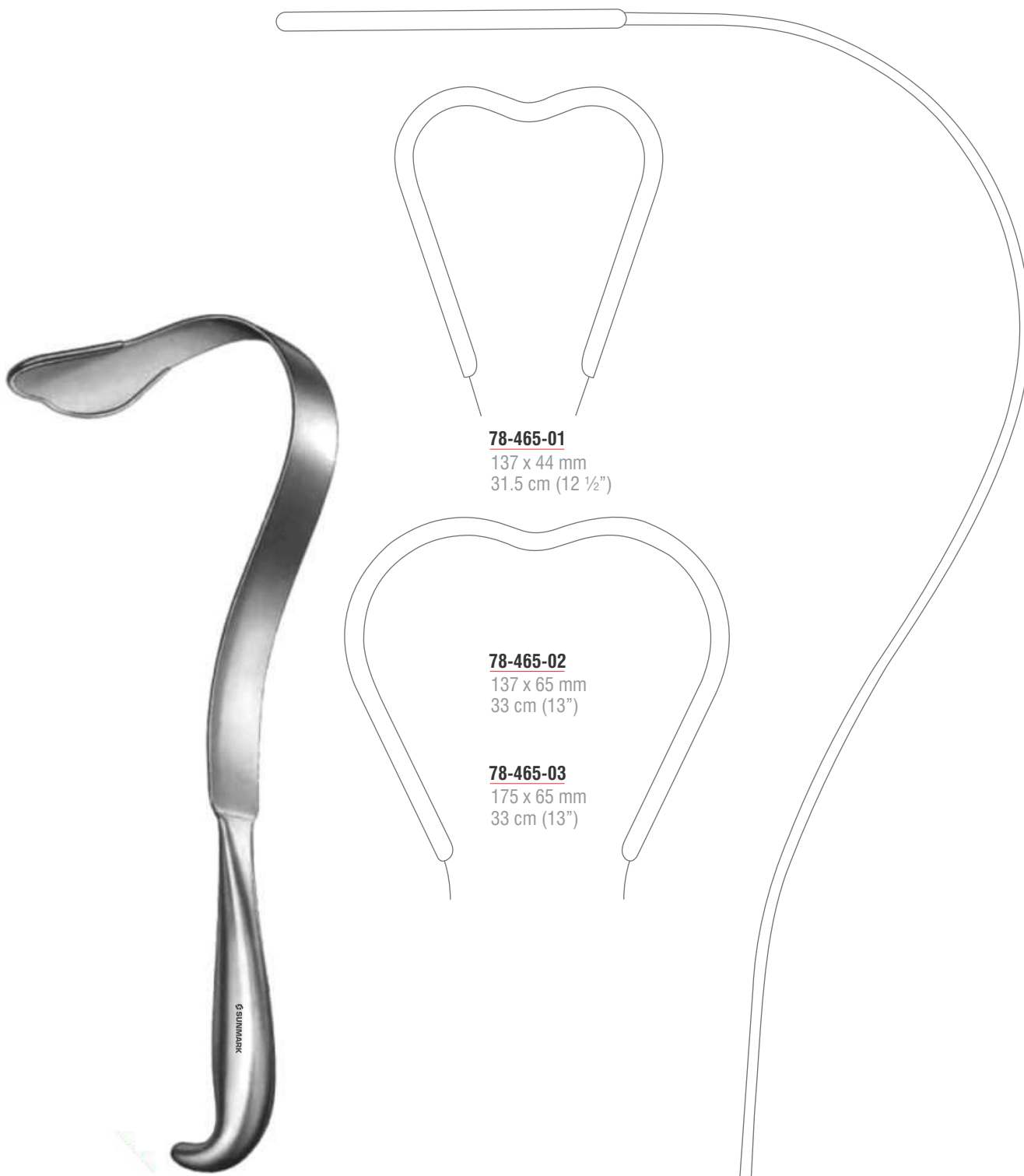

78-465-01
137 x 44 mm
31.5 cm (12 1/2")

78-465-02
137 x 65 mm
33 cm (13")

78-465-03
175 x 65 mm
33 cm (13")

Harrington Retractor

Retractors
Wundhaken, Wundhäkchen
Separadores
Ecarteurs
Divaricatori



78-467-44
Foss Gall Bladder Retractor
44 mm
Overall Length 25.5 cm (10")



78-471-01
Deaver Retractor
Fig. 1, 19 mm
Overall Length 18 cm (7")



78-471-02
Deaver Retractor
Fig. 2, 22 mm
Overall Length 21.5 cm (8 1/2")



78-471-03
Deaver Retractor
Fig. 3, 25 mm
Overall Length 25 cm (9 3/4")



78-471-04
Deaver Retractor
Fig. 4, 25 mm
Overall Length 31 cm (12 1/4")

Retractors
Wundhaken, Wundhäkchen
Separadores
Ecarteurs
Divaricatori

78

RETRACTORS



78-471-05
Deaver Retractor
Fig. 5, 25 mm
Overall Length 33 cm (13")

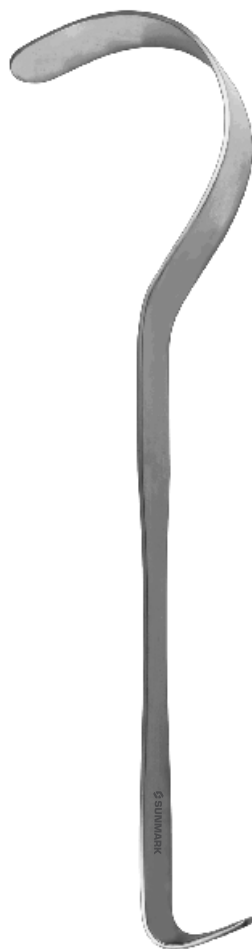

78-471-06
Deaver Retractor
Fig. 6, 25 mm
Overall Length 36 cm (14 1/4")



78-471-07
Deaver Retractor
Fig. 7, 25 mm
Overall Length 30 cm (11 3/4")



78-471-08
Deaver Retractor
Fig. 8, 50 mm
Overall Length 31 cm (12 1/4")

Retractors
Wundhaken, Wundhäkchen
Separadores
Ecarteurs
Divaricatori



78-471-09
Deaver Retractor
Fig. 9, 75 mm
Overall Length 31.5 cm (12 1/4")



Deaver Baby Retractor
Overall Length 17 cm (12 1/4")

78-473-08
8.0 mm

78-473-10
10.0 mm

78-473-12
12.0 mm

Retractors
Wundhaken, Wundhäkchen
Separadores
Ecarteurs
Divaricatori

78

RETRACTORS



Deaver Retractor
With Hollow Handle
Overall Length 31.5 cm (12 1/2")



78-475-04
Fig. 4, 25 mm

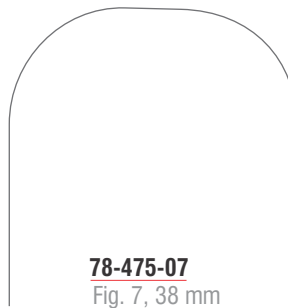

78-475-07
Fig. 7, 38 mm

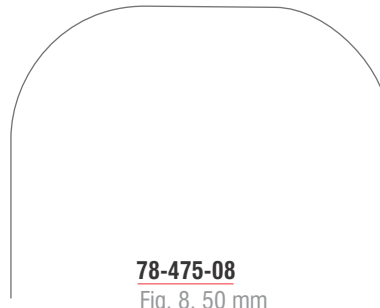

78-475-08
Fig. 8, 50 mm



78-475-10
Fig. 10, 100 mm

Retractors
 Wundhaken, Wundhäkchen
 Separadores
 Ecarteurs
 Divaricatori



Leriche Retractor

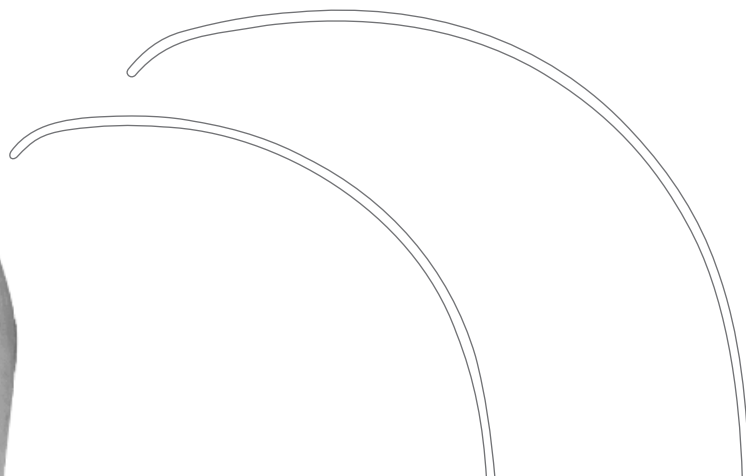

78-479-01
 45 mm
 25.5 cm (10")

78-479-02
 60 mm
 27.5 cm (10 3/4")

Retractors
Wundhaken, Wundhäkchen
Separadores
Ecarteurs
Divaricatori

78

RETRACTORS



78-479-03
Kummel Retractor
46 mm
Overall Length 28.5 cm (11 1/4")



78-481-30
Koerte Retractor
46 mm
Overall Length 30 cm (11 3/4")



Retractors
Wundhaken, Wundhäkchen
Separadores
Ecarteurs
Divaricatori



78-483-01
25 x 44 mm

78-483-02
28 x 73 mm

78-483-03
28 x 83 mm

Heaney Retractor

Overall Length 26.5 cm (10 1/2")



78-485-01
Right
45 x 48 mm

78-485-02
Right, Serrated
45 x 48 mm

Cooley Mitral Valve Retractor
Overall Length 25 cm (9 3/4")



78-485-03
Left
25 x 46 mm

Cooley Mitral Valve Retractor
Overall Length 27 cm (10 3/4")



78-485-04
Right
45 x 30 mm

78-485-05
Right
45 x 35 mm

Cooley Mitral Valve Retractor
Overall Length 25 cm (9 3/4")

Retractors
Wundhaken, Wundhäkchen
Separadores
Ecarteurs
Divaricatori



78-487-01
Right Small, 22 mm
18.5 cm (7 ¼")

78-487-02
Right Medium, 34 mm
19 cm (7 ½")

78-487-03
Right Large, 47 mm
19 cm (7 ½")

Cooley Mitral Valve Retractor

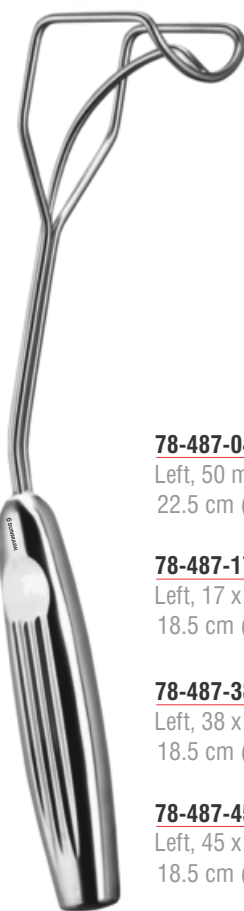

78-487-04
Left, 50 mm
22.5 cm (8 ¾")

78-487-17
Left, 17 x 19 mm
18.5 cm (7 ¼")

78-487-38
Left, 38 x 19 mm
18.5 cm (7 ¼")

78-487-45
Left, 45 x 22 mm
18.5 cm (7 ¼")

Cooley Mitral Valve Retractor



78-488-01
17 x 21 mm

78-488-02
16 x 23 mm

Borowski Aortic Valve Retractor
Overall Length 27 cm (10 ¾")

Retractors
Wundhaken, Wundhäkchen
Separadores
Ecarteurs
Divaricatori

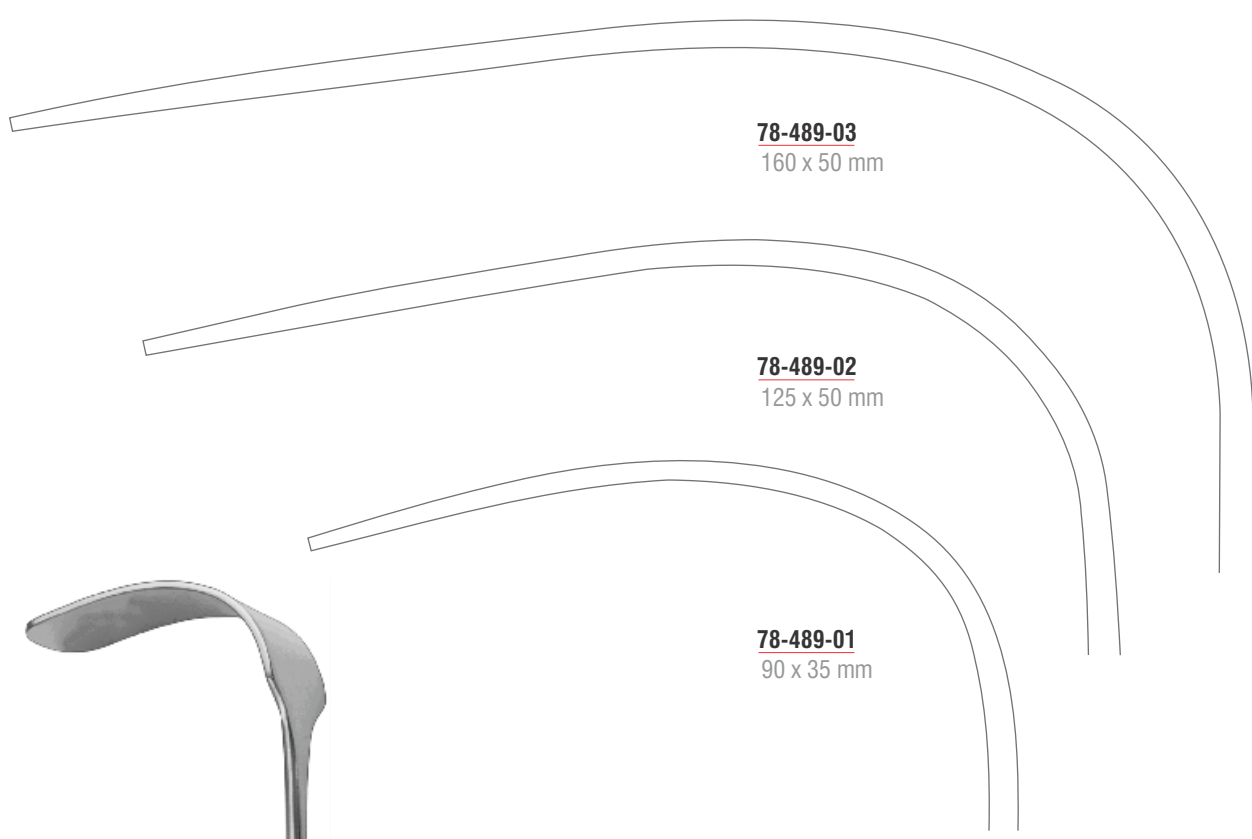

78-489-03
160 x 50 mm

78-489-02
125 x 50 mm

78-489-01
90 x 35 mm



Mikulicz Liver Retractor
Overall Length 25 cm (9 3/4")

Retractors
Wundhaken, Wundhäkchen
Separadores
Ecarteurs
Divaricatori

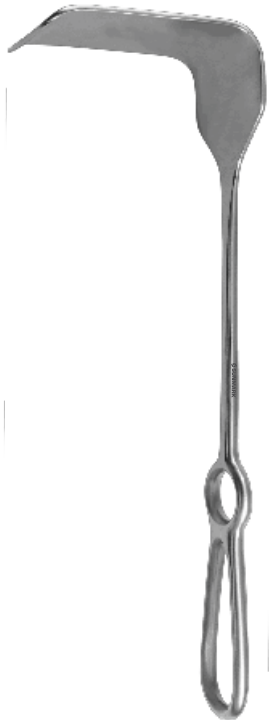

78-491-26
Mikulicz Retractor
90 x 55 mm
Overall Length 26 cm (10 1/4")



78-495-01
205 x 38



78-495-02
205 x 57

Kelly Retractor
Overall Length 27.5 cm (10 3/4")

Pelvis Retractors
Pelvishaken
Separadores para pelvis
Ecarteurs pour pelvis
Divaricatori per pelvis



St. Marks Pelvis Retractor

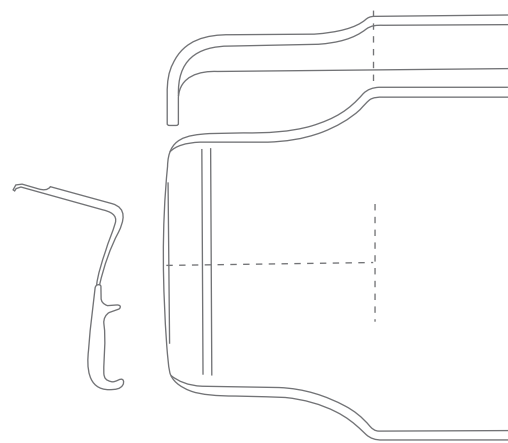

78-501-01
142 x 60 mm - 35 x 45 mm
29 cm (11 1/2")

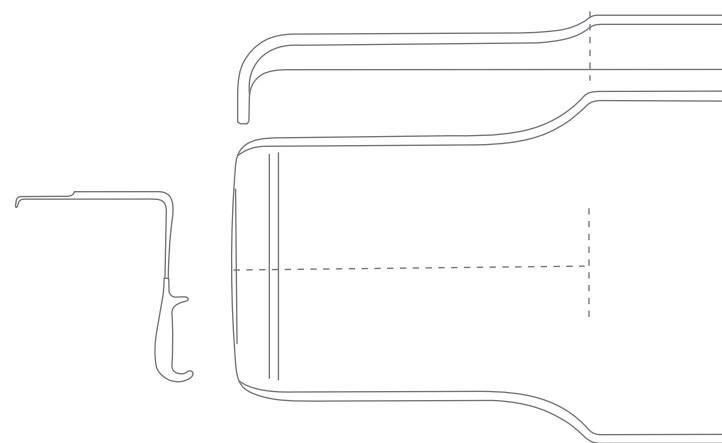

78-501-02
193 x 60 mm - 60 x 45 mm
29 cm (11 1/2")

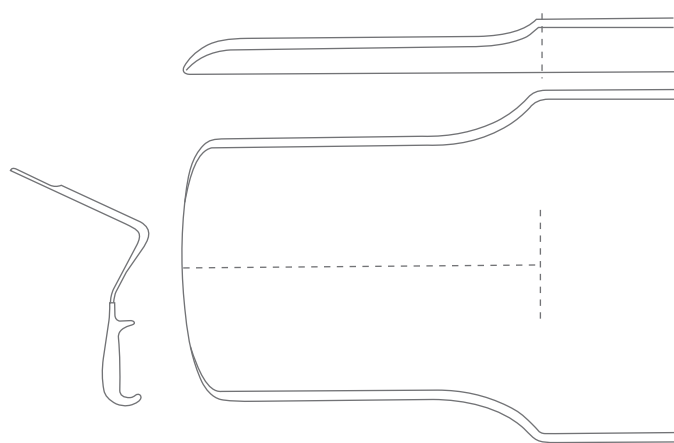

78-501-03
195 x 60 mm - 60 x 45 mm
33 cm (13")

Abdominal Spatulas
Bauchspatel
Espátulas abdominales
Spatules abdominales
Spatole addominali



78-511-28
Kummel Abdominal Spatula
45 mm
Overall Length 31 cm (12 1/4")



Kader Abdominal Spatula
Overall Length 28 cm (11")

78-515-20
20 mm

78-515-30
30 mm

78-515-40
40 mm



78-520-30
30 mm

78-520-40
40 mm

78-520-50
50 mm

78-520-60
60 mm

78-520-70
70 mm

Abdominal Spatula
Overall Length 41 cm (16")

Abdominal Spatulas
Bauchspatel
Espátulas abdominales
Spatules abdominales
Spatole addominali

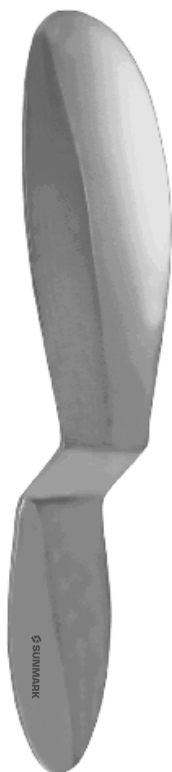

78-523-28
Reverdin Abdominal Spatula
63 x 45 mm
Overall Length 28.5 cm (11 1/4")



Abdominal Spatula
Overall Length 33 cm (13")

78-530-20
20 mm

78-5530-25
25 mm

78-530-30
30 mm

78-530-40
40 mm

78-530-50
50 mm



78-534-20
Tuffier Abdominal Spatula
Tapered, 16 x 25 mm
Overall Length 20 cm (8")



Haberer Abdominal Spatula
Tapered

78-536-01
25 x 30 mm
28 cm (11")

78-536-02
37 x 45 mm
30 cm (11 3/4")

78-536-03
40 x 50 mm
30.5 cm (12")

Abdominal Spatulas
Bauchspatel
Espátulas abdominales
Spatules abdominales
Spatole addominali



78-540-06
6.5 mm

78-540-09
9.5 mm

78-540-13
13 mm

78-540-16
16 mm

78-540-19
19 mm

78-540-25
25 mm

Martin Abdominal Spatula
Malleable, Very Soft
Overall Length 20 cm (8")



78-549-15
Kilner Cheek Retractor
Overall Length 15 cm (6")

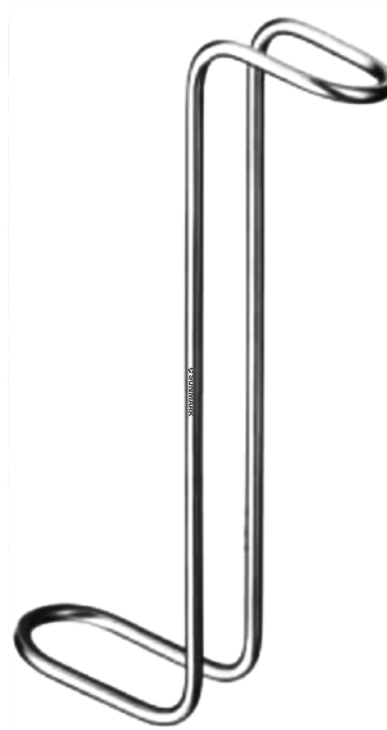

78-551-01
Collin-Hartmann Retractor
Overall Length 15 cm (6")



Sternberg Retractor

78-553-01
12 cm (4 3/4")

78-553-01
13 cm (5")

78-553-01
13.5 cm (5 1/4")



Retractors
Wundhaken, Wundhäkchen
Separadores
Ecarteurs
Divaricatori



78-555-02
Hasson "S Shaped" Retractor
Pair
Blade Width 10 mm
Overall Length 16 cm (6 1/4")

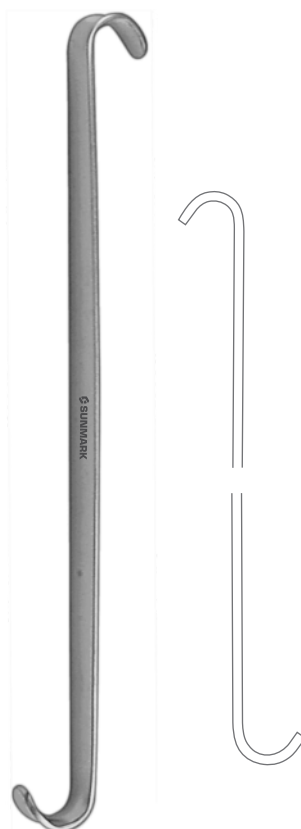

78-557-14
Roux-Mini Retractor
6 x 7 mm - 7 x 8 mm
Overall Length 14.5 cm (5 3/4")

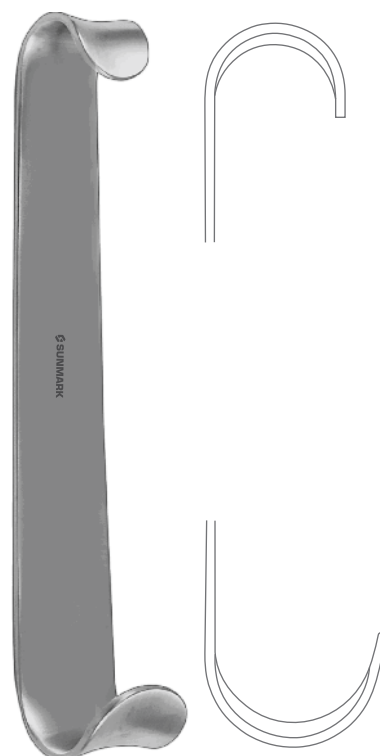

78-559-12
Roux-Baby Retractor
17 x 17 mm - 24 x 21 mm
Overall Length 12.5 cm (5")

Retractors
Wundhaken, Wundhäkchen
Separadores
Ecarteurs
Divaricatori

RETRACTORS

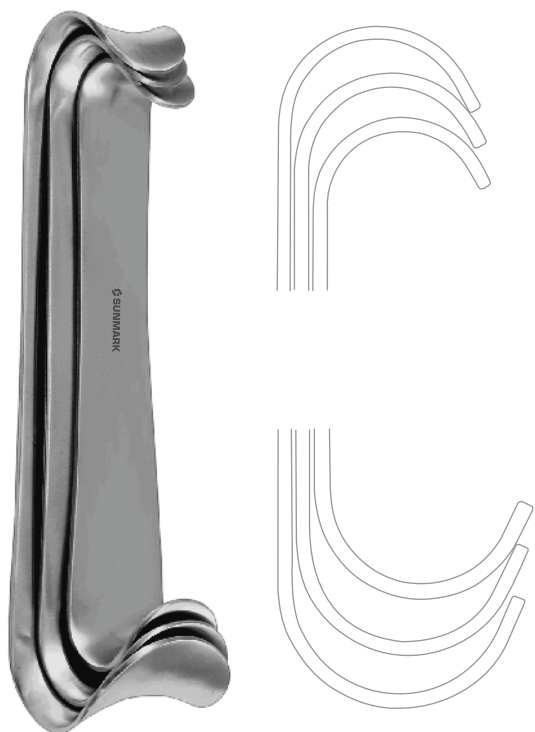

78-561-00
Roux Retractor
Set (Fig. 1,2,3)

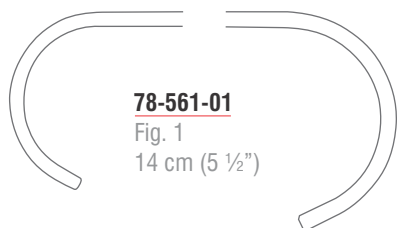

78-561-01
Fig. 1
14 cm (5 1/2")

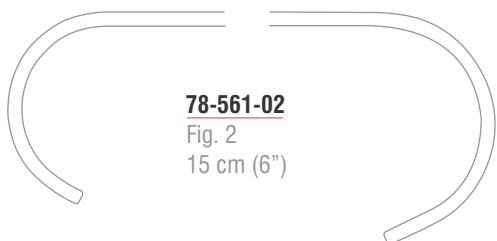

78-561-02
Fig. 2
15 cm (6")

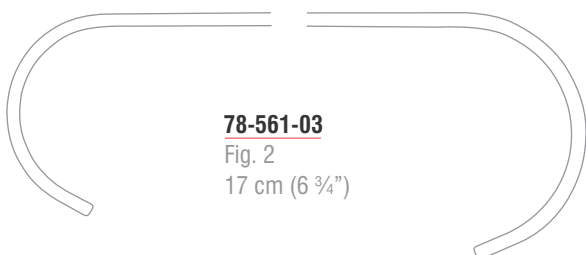

78-561-03
Fig. 2
17 cm (6 3/4")



78-563-00
Collin Retractor Set
Fig. 1
17 x 14 mm - 28 x 16 mm
Fig. 2
21 x 14 mm - 32 x 16 mm
Overall Length 15 cm (6")

Retractors
Wundhaken, Wundhäkchen
Separadores
Ecarteurs
Divaricatori

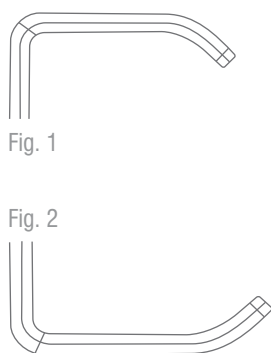

78-565-00
Farabeuf Retractor Set
Fig. 1
26 x 10 mm - 30 x 13 mm
Fig. 2
30 x 10 mm - 34 x 13 mm
Overall Length 12 cm (4 ¾")

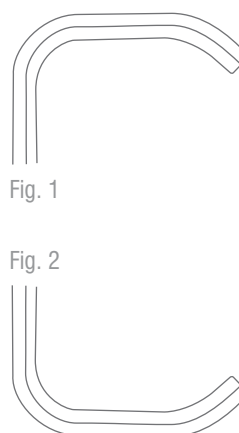

78-567-00
Farabeuf Retractor Set
Fig. 1
23 x 16 mm - 26 x 16 mm
Fig. 2
27 x 16 mm - 30 x 16 mm
Overall Length 15 cm (6")

Retractors
Wundhaken, Wundhäkchen
Separadores
Ecarteurs
Divaricatori

78

RETRACTORS



78-571-01

Fig. 1

19 x 15 mm - 19 x 15 mm,
22 x 15 mm - 22 x 15 mm
13.5 cm (5 1/4")

78-571-02

Fig. 1

26 x 25 mm - 27 x 25 mm,
29 x 25 mm - 27 x 25 mm
17.5 cm (7")

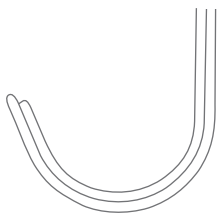

Parker Retractor Set

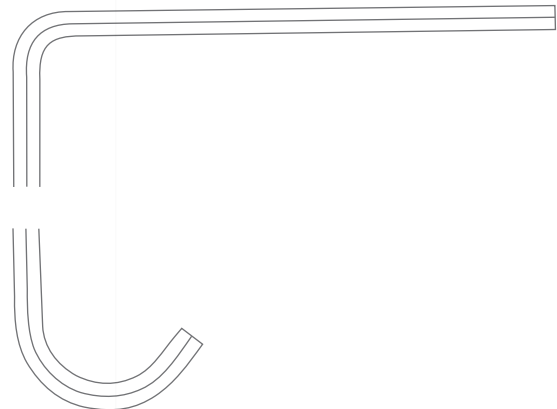

78-573-16

Parker-Mott Retractor Set

21 x 24 mm - 68 x 24 mm, 25 x 24 mm - 72 x 24 mm
Overall Length 16 cm (6 1/4")



Retractors
 Wundhaken, Wundhäkchen
 Separadores
 Ecarteurs
 Divaricatori

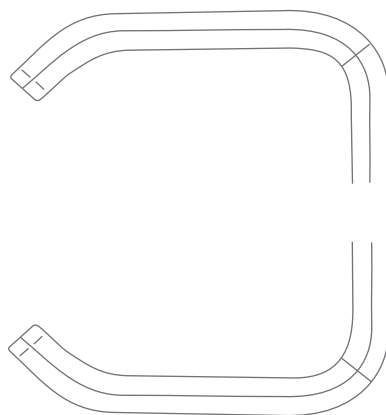

78-577-20
Mathieu Retractor Set
 Fig. 1
 42 x 13 mm - 42 x 26 mm
 Fig. 2
 47 x 13 mm - 46 x 26 mm
 Overall Length 20 cm (8")

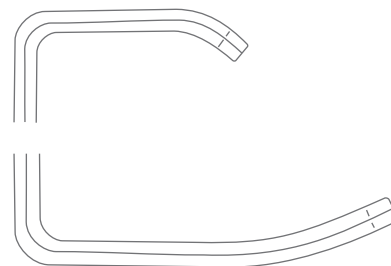

78-579-21
Parker-Langenbeck (US Army) Retractor
 Fig. 1
 21 x 15 mm - 40 x 15 mm
 Fig. 2
 25 x 15 mm - 45 x 15 mm
 Overall Length 21.5 cm (8 1/2")

Retractors
Wundhaken, Wundhäkchen
Separadores
Ecarteurs
Divaricatori

78

RETRACTORS



78-581-16
Hajek Retractor
30 x 18 mm - 25 x 10 mm
Overall Length 16.5 cm (6 1/2")



78-583-01
30 x 13 mm
35 x 19 mm

78-583-02
30 x 25 mm
35 x 32 mm

Lane Retractor
Overall Length 23 cm (9")



78-591-17
Czerny Retractor
38 x 22 mm - 38 x 22 mm
Overall Length 17.5 cm (7")

Retractors
Wundhaken, Wundhäkchen
Separadores
Ecarteurs
Divaricatori



78-593-19
Goelet Retractor
40 x 40 mm - 30 x 30 mm
Overall Length 19 cm (7 ½")



78-595-01
16 mm
19 cm (7 ½")

78-595-02
20 mm
19 cm (7 ½")

78-595-03
25 mm
20 cm (8")

Canny-Ryall Retractor



78-597-11
Crile Retractor
3 x 11 mm - 6 x 20 mm
Overall Length 11.5 cm (4 ½")

Wound Spreaders, Self-Retaining
Wundspreizer
Separadores autoestáticos
Ecarteurs autostatiques
Divaricatori autostatici

RETRACTORS



78-650-05
2 x 3
Sharp Prongs

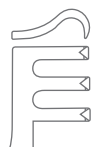

78-651-05
2 x 3
Blunt Prongs

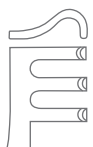

Finsen Wound Spreader
Overall Length 5 cm (2")



78-652-07
3 x 4
Sharp Prongs

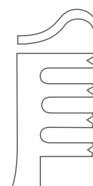

78-653-07
3 x 4
Blunt Prongs



Finsen Wound Spreader
Overall Length 7 cm (2 3/4")



78-654-07
3 x 4
Sharp Prongs

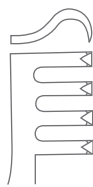

78-655-07
3 x 4
Blunt Prongs

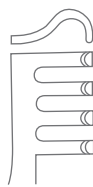

Finsen-Martin Wound Spreader
With Adjustment Screw
Overall Length 7 cm (2 3/4")

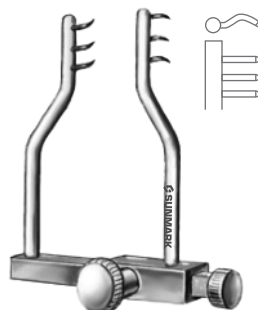

78-658-04
Logan Wound Spreader
3 x 3 Sharp - With Adjustment Screw
Overall Length 4 cm (1 1/2")



Wound Spreaders, Self-Retaining
Wundspreizer
Separadores autoestáticos
Ecarteurs autostatiques
Divaricatori autostatici



78-661-30
Bose Fat Spreader for Coronary Surgery
Overall Length 3 cm (1 1/4")



78-663-40
4 cm (1 1/2")

78-663-55
5.5 cm (2 1/4")

Fat Spreader for Coronary Surgery



Spring Wire Retractor

78-665-03
3 Toothed Blades
8.5 cm (3 1/2")

78-665-04
4 Toothed Blades
11.5 cm (4 1/2")

Wound Spreaders, Self-Retaining
Wundspreizer
Separadores autoestáticos
Ecarteurs autostatiques
Divaricatori autostatici



78-666-06
Buckley Wound Spreader
3 x 3 Sharp Prongs
Overall Length 6 cm (2 1/4")



Alm Wound Spreader



78-668-07
4 x 4 Sharp Prongs
7 cm (2 3/4")

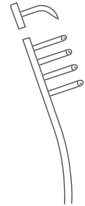

78-668-10
4 x 4 Sharp Prongs
10 cm (4")



78-669-07
4 x 4 Blunt Prongs
7 cm (2 3/4")



78-669-10
4 x 4 Blunt Prongs
10 cm (4")



78-672-10
Allport Wound Spreader
4 x 4 Sharp Prongs
Overall Length 9.5 cm (3 3/4")



78-674-10
4 x 4 Sharp Prongs
78-674-10
4 x 4 Blunt Prongs

Wound Spreader
Overall Length 10 cm (4")

Wound Spreaders, Self-Retaining
Wundspreizer
Separadores autoestáticos
Ecarteurs autostatiques
Divaricatori autostatici



78-677-10
Jansen Self Retaining Retractor
3 x 3 Blunt Prongs
With Adjustment Screw
Overall Length 10 cm (4")

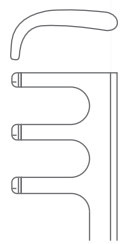

Scalp-Contour Self Retaining Retractor
Overall Length 13.5 cm (5 1/4")

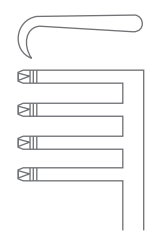

78-680-13
3 x 4 Sharp Prongs

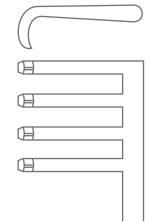

78-681-13
3 x 4 Blunt Prongs

Wound Spreaders, Self-Retaining
Wundspreizer
Separadores autoestáticos
Ecarteurs autostatiques
Divaricatori autostatici



78-684-20
7 x 7 Sharp Prongs

78-685-20
7 x 7 Blunt Prongs

Miskimon Self Retaining Retractor
Overall Length 20.5 cm (8")

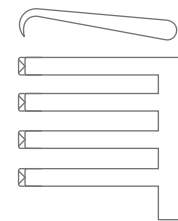

78-686-20
4 x 4 Sharp Prongs

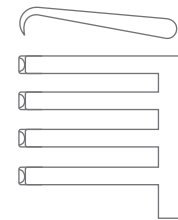

78-687-20
4 x 4 Blunt Prongs

Anderson-Adson Self Retaining Retractor
Overall Length 20 cm (8")

Wound Spreaders, Self-Retaining
Wundspreizer
Separadores autoestáticos
Ecarteurs autostatiques
Divaricatori autostatici



78-689-21
Traverse Self Retaining Retractor
4 x 5 Blunt Prongs
Overall Length 21.5 cm (8 1/2")



78-691-22
Norfolk-Norwich Self Retaining Retractor
4 x 5 Blunt Prongs
Overall Length 22 cm (8 3/4")

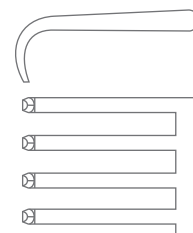

Wound Spreaders, Self-Retaining
Wundspreizer
Separadores autoestáticos
Ecarteurs autostatiques
Divaricatori autostatici

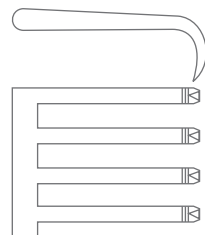

78-696-20
3 x 4 Sharp Prongs

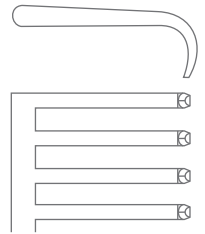

78-697-20
3 x 4 Blunt Prongs

Weitlaner Self Retaining Retractor
Overall Length 20 cm (8")

Wound Spreaders, Self-Retaining
Wundspreizer
Separadores autoestáticos
Ecarteurs autostatiques
Divaricatori autostatici



Adson Self Retaining Retractor

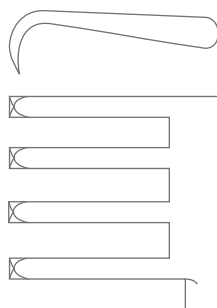

78-700-26
3 x 4 Sharp Prongs
26 cm (10 1/4")

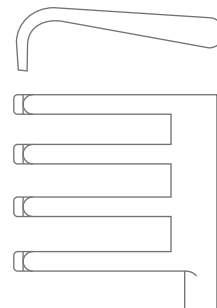

78-701-26
3 x 4 Blunt Prongs
26 cm (10 1/4")

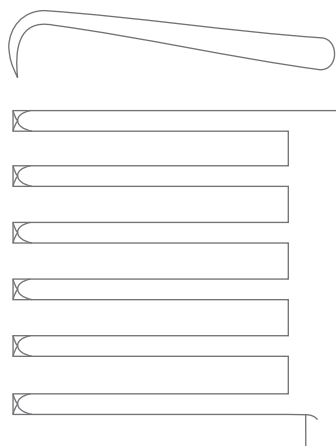

78-702-26
6 x 6 Sharp Prongs
29 cm (11 1/2")

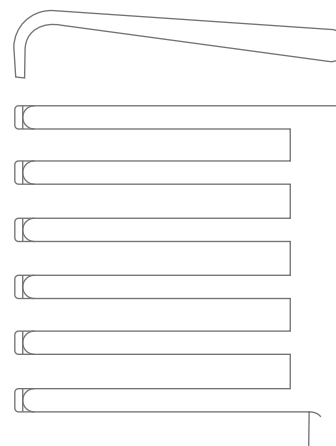

78-703-26
6 x 6 Blunt Prongs
29 cm (11 1/2")

Wound Spreaders, Self-Retaining
Wundspreizer
Separadores autoestáticos
Ecarteurs autostatiques
Divaricatori autostatici

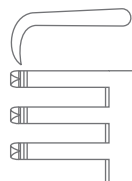

78-710-11
2 x 3 Sharp Prongs

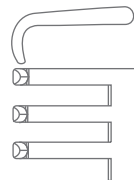

78-711-11
2 x 3 Blunt Prongs

Weitlaner Self Retaining Retractor
Overall Length 11 cm (4 1/4")

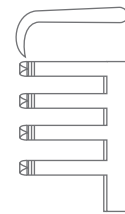

78-712-13
3 x 4 Sharp Prongs
13.5 cm (5 1/4")

78-712-16
3 x 4 Sharp Prongs
16 cm (6 1/4")

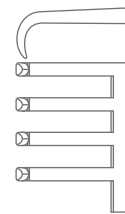

78-713-13
3 x 4 Blunt Prongs
13.5 cm (5 1/4")

78-713-16
3 x 4 Blunt Prongs
16 cm (6 1/4")

Weitlaner Self Retaining Retractor

Wound Spreaders, Self-Retaining
Wundspreizer
Separadores autoestáticos
Ecarteurs autostatiques
Divaricatori autostatici



Weitlaner-Wullstein Self Retaining Retractor
Overall Length 13 cm (5")

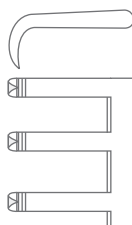

78-716-13
3 x 3 Sharp Prongs

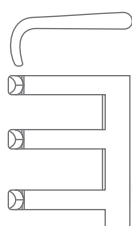

78-717-13
3 x 3 Blunt Prongs



Perkins Self Retaining Retractor
Overall Length 13 cm (5")

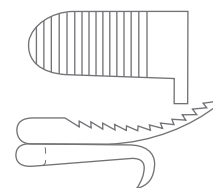

78-721-01
Right

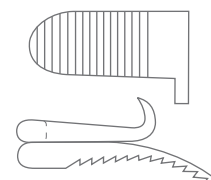

78-721-02
Left

Wound Spreaders, Self-Retaining
Wundspreizer
Separadores autoestáticos
Ecarteurs autostatiques
Divaricatori autostatici

78

RETRACTORS



78-725-14
Jefferson Self Retaining Retractor
2 x 3 Blunt Prongs
Overall Length 14 cm (5 1/2")



78-726-16

78-726-16 WC
With Central Blade

Mayo-Adams Self Retaining Retractor
2 x 2 Blunt Prongs
Overall Length 16.5 cm (6 1/2")

Wound Spreaders, Self-Retaining
Wundspreizer
Separadores autoestáticos
Ecarteurs autostatiques
Divaricatori autostatici



78-728-14
Mollison Self Retaining Retractor
2 x 2 Sharp Prongs
Overall Length 14 cm (5 1/2")

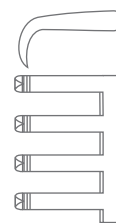

78-730-15
Mollison Self Retaining Retractor
4 x 4 Blunt Prongs
Overall Length 15.5 cm (6")

Wound Spreaders, Self-Retaining
Wundspreizer
Separadores autoestáticos
Ecarteurs autostatiques
Divaricatori autostatici



Plester Self Retaining Retractor
Overall Length 13 cm (5")

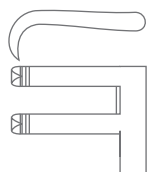

78-732-13
2 x 2 Sharp Prongs

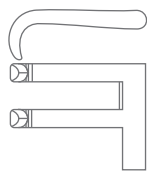

78-733-13
2 x 2 Blunt Prongs

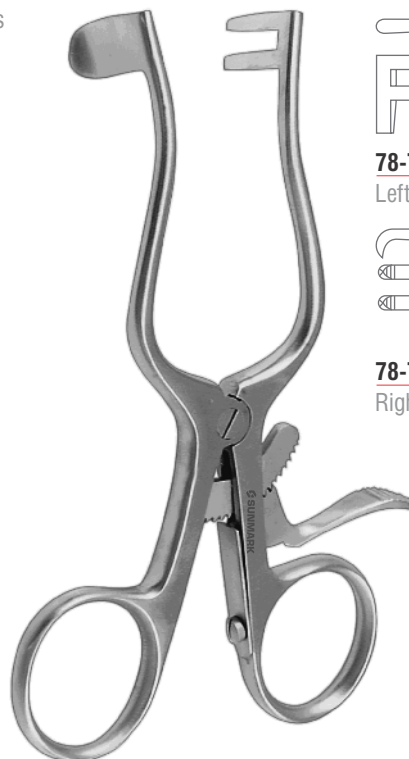

Plester Self Retaining Retractor
Overall Length 10.5 cm (4")

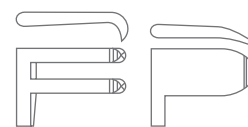

78-735-01
Left

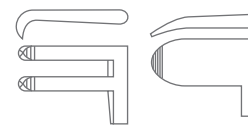

78-735-02
Right



Wound Spreaders, Self-Retaining
Wundspreizer
Separadores autoestáticos
Ecarteurs autostatiques
Divaricatori autostatici



78-737-13
Milligan Self Retaining Retractor
3 x 3 Blunt Prongs
Overall Length 13.5 cm (5 1/4")

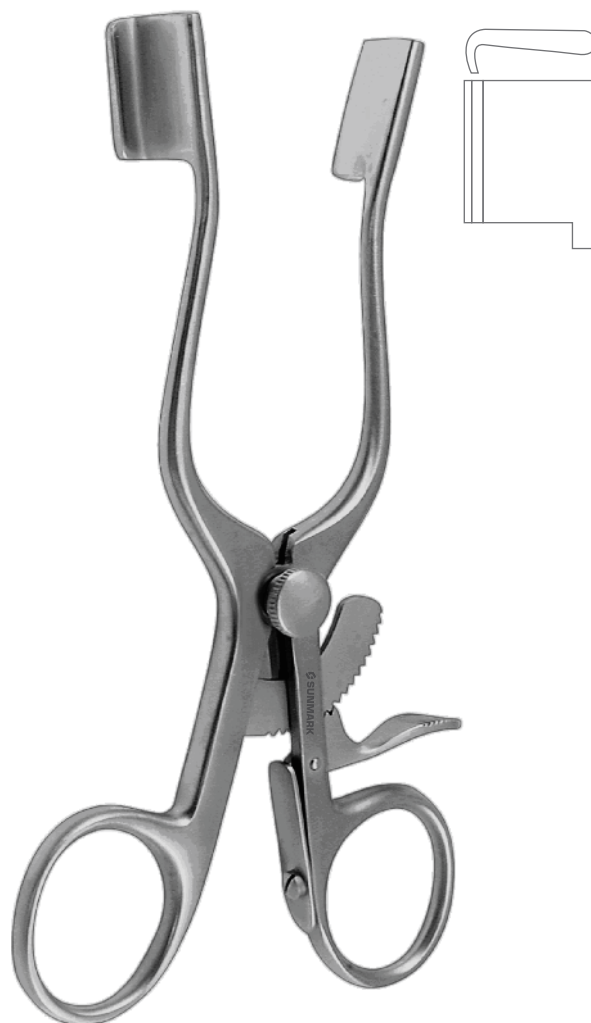

78-739-13
Weitlaner-Baby Self Retaining Retractor
Blunt
Overall Length 13.5 cm (5 1/4")

Wound Spreaders, Self-Retaining
Wundspreizer
Separadores autoestáticos
Ecarteurs autostatiques
Divaricatori autostatici

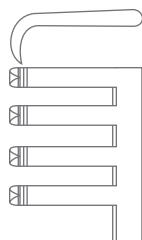

78-742-13
3 x 4 Sharp Prongs
14 cm (5 1/2")

78-742-16
3 x 4 Sharp Prongs
16.5 cm (6 1/2")

78-742-21
3 x 4 Sharp Prongs
21 cm (8 1/4")

78-742-13
3 x 4 Sharp Prongs
24.5 cm (9 3/4")

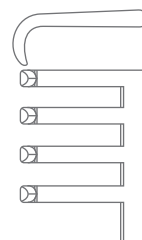

78-743-13
3 x 4 Blunt Prongs
14 cm (5 1/2")

78-743-16
3 x 4 Blunt Prongs
16.5 cm (6 1/2")

78-743-21
3 x 4 Blunt Prongs
21 cm (8 1/4")

78-743-13
3 x 4 Blunt Prongs
24.5 cm (9 3/4")

Adson Self Retaining Retractor

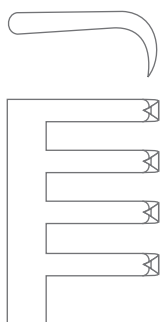

78-750-32
4 x 4 Sharp Prongs
32 cm (12 1/2")

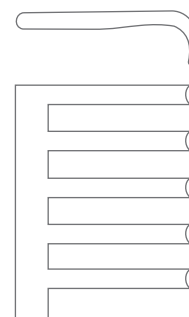

78-753-33
4 x 5 Blunt Prongs
33 cm (13")

Beckmann Self Retaining Retractor

Adson Self Retaining Retractor

Wound Spreaders, Self-Retaining
Wundspreizer
Separadores autoestáticos
Ecarteurs autostatiques
Divaricatori autostatici



78-758-28
Harvey-Jackson Self Retaining Retractor
3 x 3 Sharp Prongs
Overall Length 28 cm (11")



78-760-30
Beckmann-Adson Self Retaining Retractor
4 x 4 Short Sharp Prongs
Overall Length 30.5 cm (12")

Wound Spreaders, Self-Retaining
Wundspreizer
Separadores autoestáticos
Ecarteurs autostatiques
Divaricatori autostatici



Beckmann-Adson Self Retaining Retractor
Overall Length 30.5 cm (12")

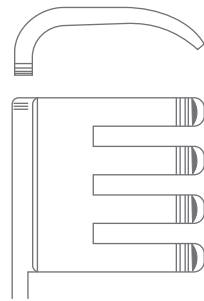

78-761-30
4 x 4 Short
Blunt Prongs

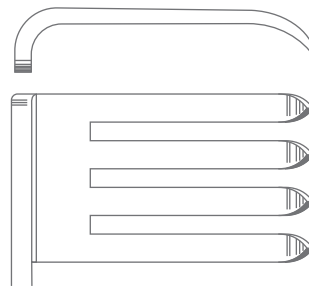

78-762-30
4 x 4 Long
Sharp Prongs

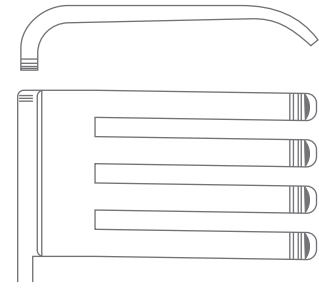

78-763-30
4 x 4 Long
Blunt Prongs

Wound Spreaders, Self-Retaining
Wundspreizer
Separadores autoestáticos
Ecarteurs autostatiques
Divaricatori autostatici



78-766-32
Beckmann-Eaton Self Retaining Retractor
7 x 7 Sharp Prongs
Overall Length 32 cm (12 1/2")

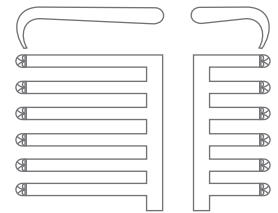

78-770-01
6 x 6 Sharp Long Prongs
Teeth on Left Side

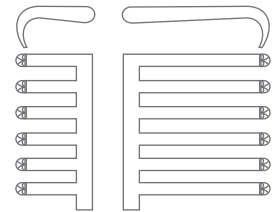

78-770-02
6 x 6 Sharp Long Prongs
Teeth on Right Side

Beckmann-Eaton Self Retaining Retractor
Overall Length 28.5 cm (11 1/4")

Wound Spreaders, Self-Retaining
Wundspreizer
Separadores autoestáticos
Ecarteurs autostatiques
Divaricatori autostatici



78-801-15
Joll (Friedman) Self Retaining Retractor
Thyroid and Vaginal Retractor
Overall Length 15.5 cm (6")



78-805-13
13 cm (5")

78-805-15
15 cm (6")

78-805-18
18.5 cm (7 1/4")

Gelpi Self Retaining Retractor

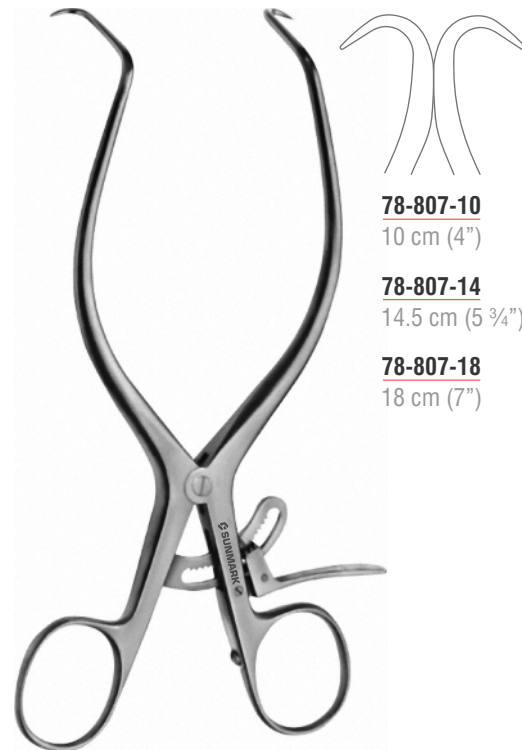

78-807-10
10 cm (4")

78-807-14
14.5 cm (5 3/4")

78-807-18
18 cm (7")

Gelpi Self Retaining Retractor

Wound Spreaders, Self-Retaining
Wundspreizer
Separadores autoestáticos
Ecarteurs autostatiques
Divaricatori autostatici



78-811-18
Gelpi Self Retaining Retractor
Overall Length 18.5 cm (7 1/4")



78-813-18
Jackson-Burrows Self Retaining Retractor
Overall Length 18.5 cm (7 1/4")



78-820-00
Collin-Baby Retractor Complete
Overall Length 20 cm (8")



78-822-00
Collin Retractor Complete
With 1 Pair of Lateral Blades



78-822-01
Collin Retractor Only
Without Blade
Overall Length 24 cm (9 1/2")

Abdominal Retractors
Bauchdeckenhalter
Separadores abdominales
Ecarteurs abdominaux
Divaricatori addominali



78-823-00
Collin Retractor Complete
With Central Blades Ref: 78-823-90
and 1 Pair of Lateral Blades Ref: 78-835-38



78-823-01
Collin Retractor Only
Without Blades
Overall Length 13 cm (5")

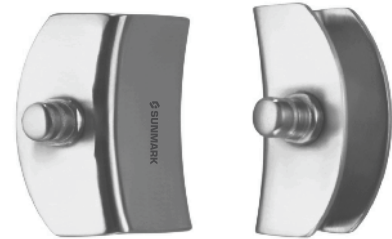

78-823-90
Collin Central Blade
38 x 55 mm



78-824-00
Collin Retractor Complete
With Central Blades Ref: 78-824-90
and 1 Pair of Lateral Blades Ref: 78-835-45
Overall Length 22.5 cm (8 3/4")



78-824-90
Collin Central Blade
50 x 75 mm

Abdominal Retractors
Bauchdeckenhalter
Separadores abdominales
Ecarteurs abdominaux
Divaricatori addominali



78-826-00
Collin Retractor Complete
With Central Blade Ref:- 78-826-90
and 1 Pair of Lateral Blades Ref:- 78-835-60



78-826-01
Collin Retractor Only
Without Blade
Overall Length 31 cm (12 1/4")

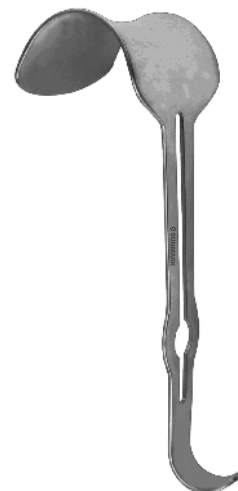

78-826-90
Collin Retractor Only
60 x 75 mm

Abdominal Retractors
Bauchdeckenhalter
Separadores abdominales
Ecarteurs abdominaux
Divaricatori addominali

78

RETRACTORS



78-830-00
Ricard Retractor Complete
With Central Blade Ref:- 78-830-02
and 1 Pair of Lateral Blades Ref:- 78-835-90

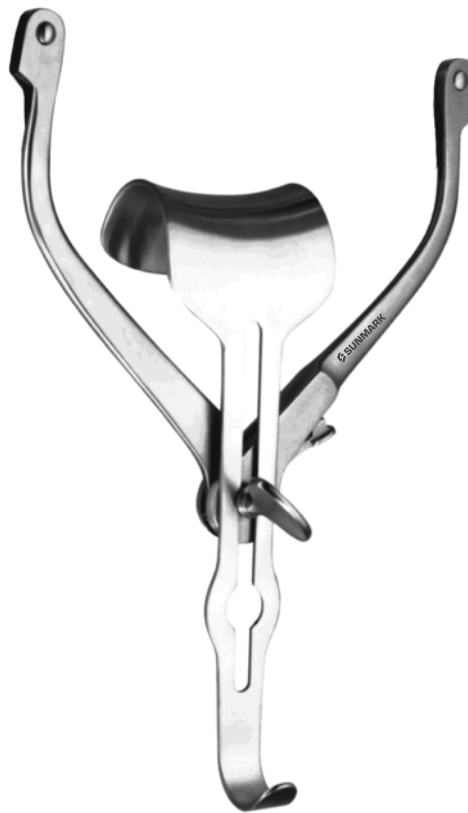

78-830-01
Ricard Retractor Only



78-830-02
Ricard Retractor Only
55 x 70 mm

Abdominal Retractors
Bauchdeckenhalter
Separadores abdominales
Ecarteurs abdominaux
Divaricatori addominali



78-832-00

Ricard Retractor Complete

With Central Blade Ref:- 78-832-02
and 1 Pair of Lateral Blades Ref:- 78-835-92



78-832-02

Ricard Retractor Only

80 x 90 mm



Ricard Central Blade

78-835-18
18 x 40 mm

78-835-27
27 x 40 mm

78-835-38
38 x 60 mm

78-835-40
40 x 80 mm

78-835-45
45 x 80 mm

78-835-50
50 x 70 mm

78-835-52
52 x 70 mm

78-835-60
60 x 80 mm



78-835-70
70 x 55 mm

78-835-80
75 x 90 mm

78-835-90
50 x 58 mm

78-835-92
60 x 80 mm

78-835-94
72 x 85 mm



Abdominal Retractors
Bauchdeckenhalter
Separadores abdominales
Ecarteurs abdominaux
Divaricatori addominali

RETRACTORS

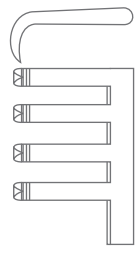

78-840-01
3 x 4 Sharp Prongs
With 3 Central Blades
Ref:- 78-840-19, 78-840-25
and 78-840-32

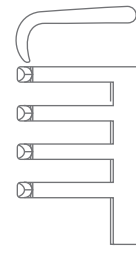

78-840-02
3 x 4 Blunt Prongs
With 3 Central Blades
Ref:- 78-840-19, 78-840-25
and 78-840-32

Henley Retractor Complete
Overall Length 16 cm (6 1/4")

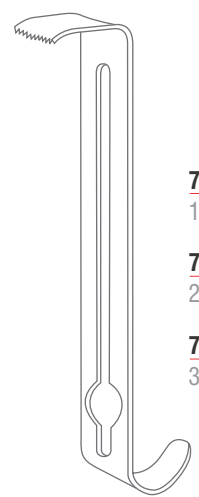

78-840-19
19 x 17 mm

78-840-25
25 x 17 mm

78-840-32
32 x 17 mm

Henley Central Blade

Abdominal Retractors
Bauchdeckenhalter
Separadores abdominales
Ecarteurs abdominaux
Divaricatori addominali



78-850-00
Millin Retractor Complete
With Central Blade Ref:- 78-850-90, 1 Pair Each of
Lateral Blades Ref:- 78-851-57 and Ref:- 78-851-82



78-850-01
Millin Retractor Only

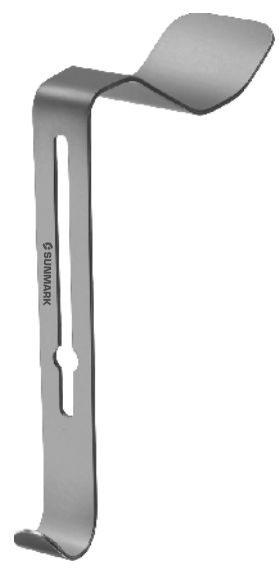

78-850-90
Millin Central Blade Only
105 x 45 mm



78-851-57
57 x 25 mm

78-851-82
82 x 25 mm

Millin Lateral Blade

Abdominal Retractors
Bauchdeckenhalter
Separadores abdominales
Ecarteurs abdominaux
Divaricatori addominali

78

RETRACTORS



78-853-26
Lagueu Retractor
90 x 35 mm
Overall Length 26 cm (10 1/4")



78-855-28
Millin Retractor
70 mm
Overall Length 28 cm (11")

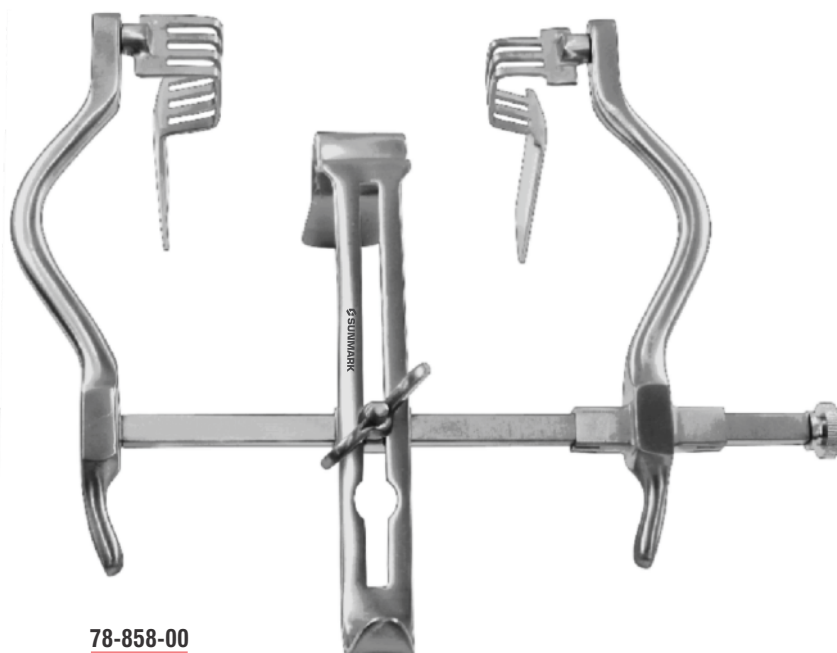

78-858-00
Judd-Masson Retractor
Spread 120 mm

Abdominal Retractors
Bauchdeckenhalter
Separadores abdominales
Ecarteurs abdominaux
Divaricatori addominali



78-861-00
Vickers Low-Profile Retractor Complete
2 x 2 Blunt Prongs, With Central Blade
Ref:- 78-801-01
Overall Length 7.5 cm (3")

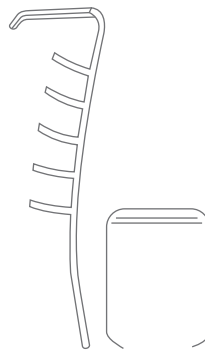

78-861-01
10 x 18 mm

78-861-02
12 x 10 mm

Vickers Low-Profile Central Blade



78-863-00
Vickers Low-Profile Retractor Complete
3 x 3 Blunt Prongs, With Central Blade
Ref:- 78-861-01
Overall Length 9 cm (3 1/2")



78-865-00
Vickers Low-Profile Retractor Complete
With Central Blade Ref:- 78-861-01
Overall Length 7.5 cm (3")



Abdominal Retractors
Bauchdeckenhalter
Separadores abdominales
Ecarteurs abdominaux
Divaricatori addominali



78-869-00
Vickers Self Retaining Retractor
Blunt Ring Model For Thumb And Fingers
Overall Length 5 cm (2")

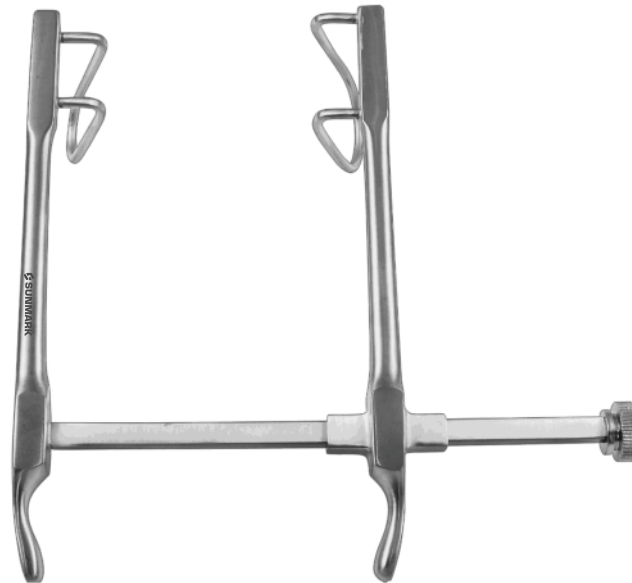

78-880-00
Gosset-Baby Retractor
120 mm, 40 x 30 mm
Overall Length 12.5 cm (5")

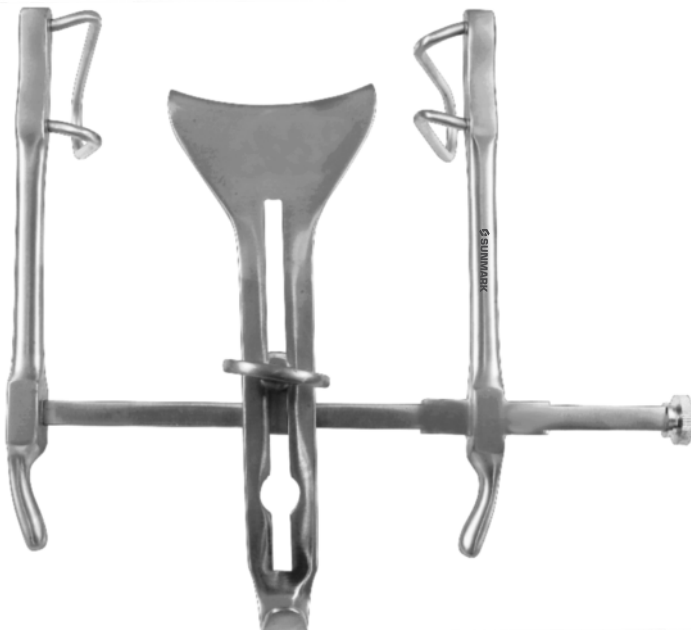

78-884-00
Gosset Retractor Complete
With Central Blade Ref:- 78-884-90
160 mm, 63 x 35 mm
Overall Length 16.5 cm (6 1/2")



78-844-90
Gosset Central Blade
60 x 56 mm

Abdominal Retractors
Bauchdeckenhalter
Separadores abdominales
Ecarteurs abdominaux
Divaricatori addominali

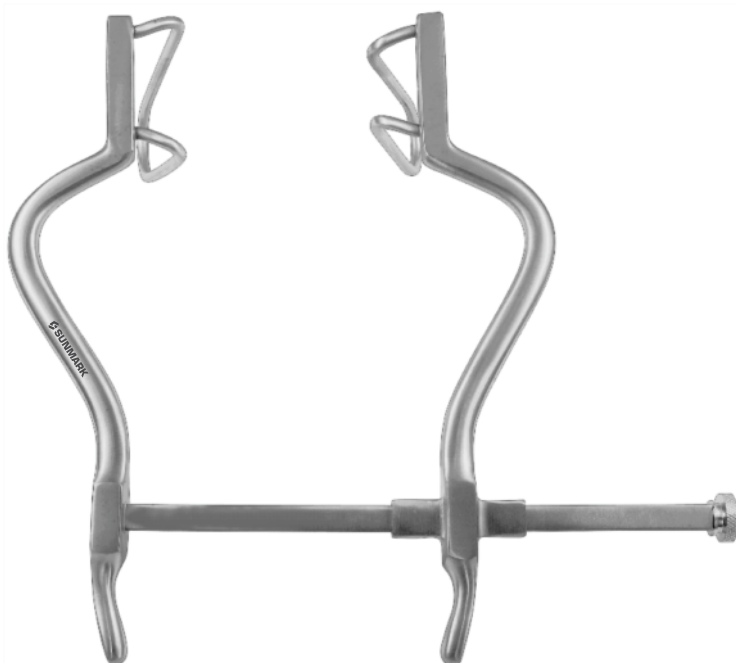

78-886-00
Gosset Retractor
Overall Length 18.5 cm (7 1/4")

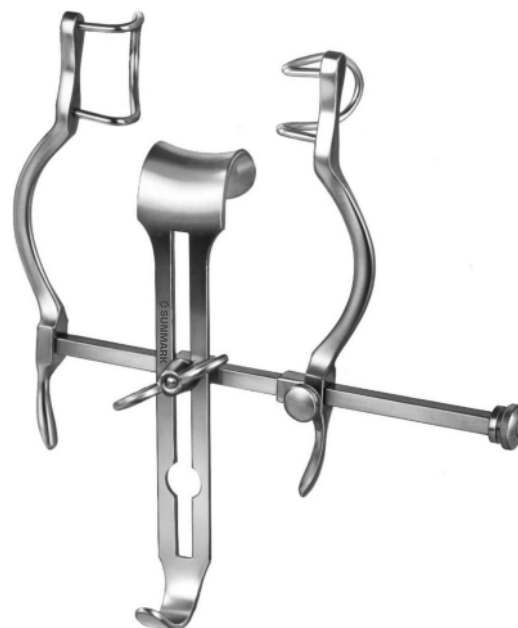

78-890-00
Balfour-Baby Retractor Complete
With Central Blade Ref:- 78-890-90
95 mm
Overall Length 12.5 cm (5")

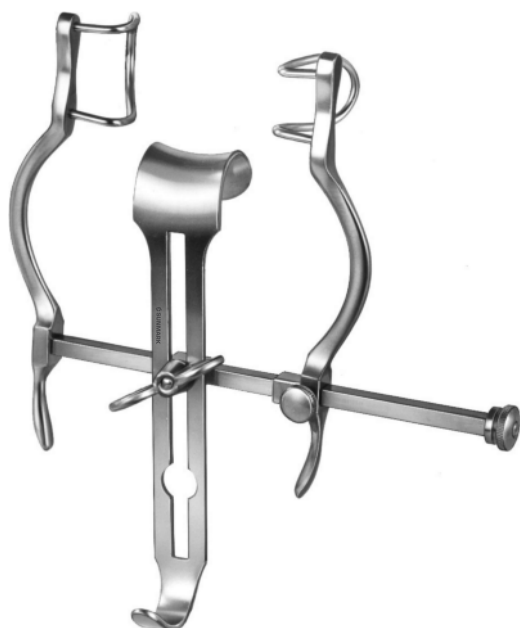

78-890-90
Balfour-Baby Central Blade
24 x 20 mm



Abdominal Retractors
Bauchdeckenhalter
Separadores abdominales
Ecarteurs abdominaux
Divaricatori addominali

78

RETRACTORS

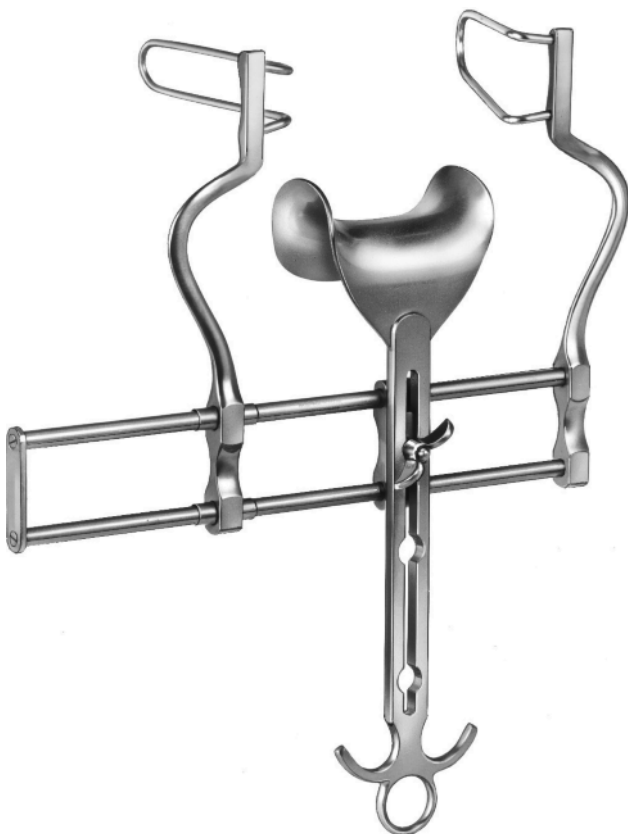

78-892-00

Systunk Nail Splitting Scissor

With Central Blade Ref:- 78-903-01

180 mm, 70 x 35 mm

Overall Length 20 cm (8")

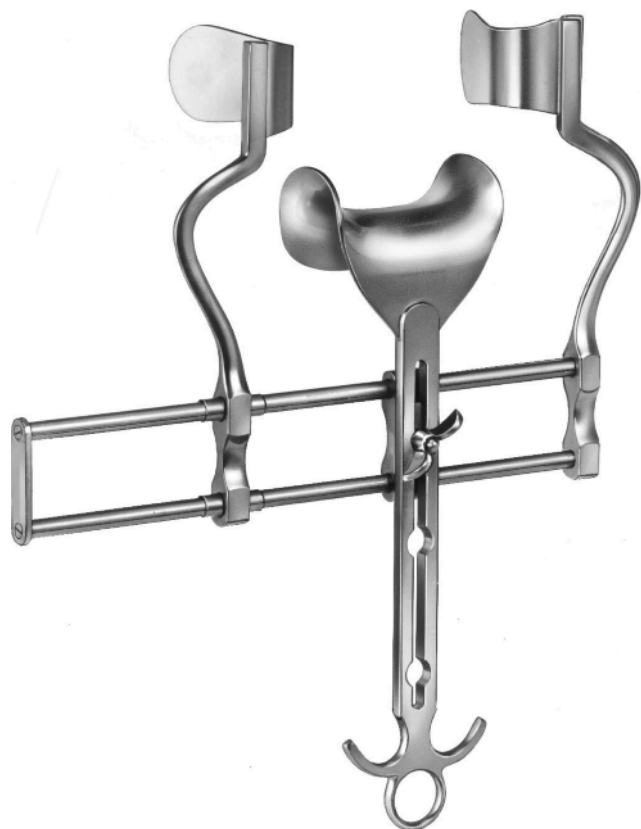

78-894-00

Balfour Retractor Complete

With Central Blade Ref:- 78-903-01

180 mm, 70 x 35 mm

Overall Length 20 cm (8")

Abdominal Retractors
Bauchdeckenhalter
Separadores abdominales
Ecarteurs abdominaux
Divaricatori addominali

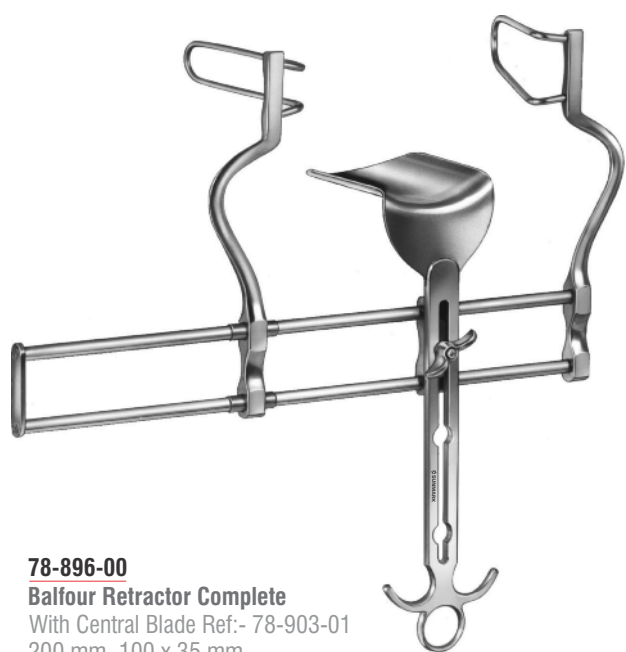

78-896-00
Balfour Retractor Complete
With Central Blade Ref:- 78-903-01
200 mm, 100 x 35 mm
Overall Length 20 cm (8")

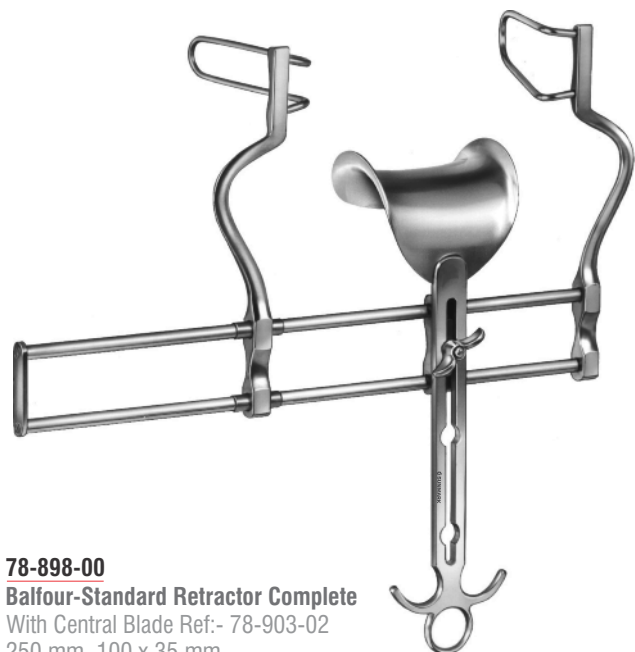

78-898-00
Balfour-Standard Retractor Complete
With Central Blade Ref:- 78-903-02
250 mm, 100 x 35 mm
Overall Length 20 cm (8")



78-901-90
100 x 70 mm

78-901-91
100 x 60 mm

Balfour Central Blade



78-903-01
40 x 80 mm

78-903-02
68 x 85 mm

78-903-03
40 x 68 mm

Balfour Central Blade

Abdominal Retractors
Bauchdeckenhalter
Separadores abdominales
Ecarteurs abdominaux
Divaricatori addominali

RETRACTORS

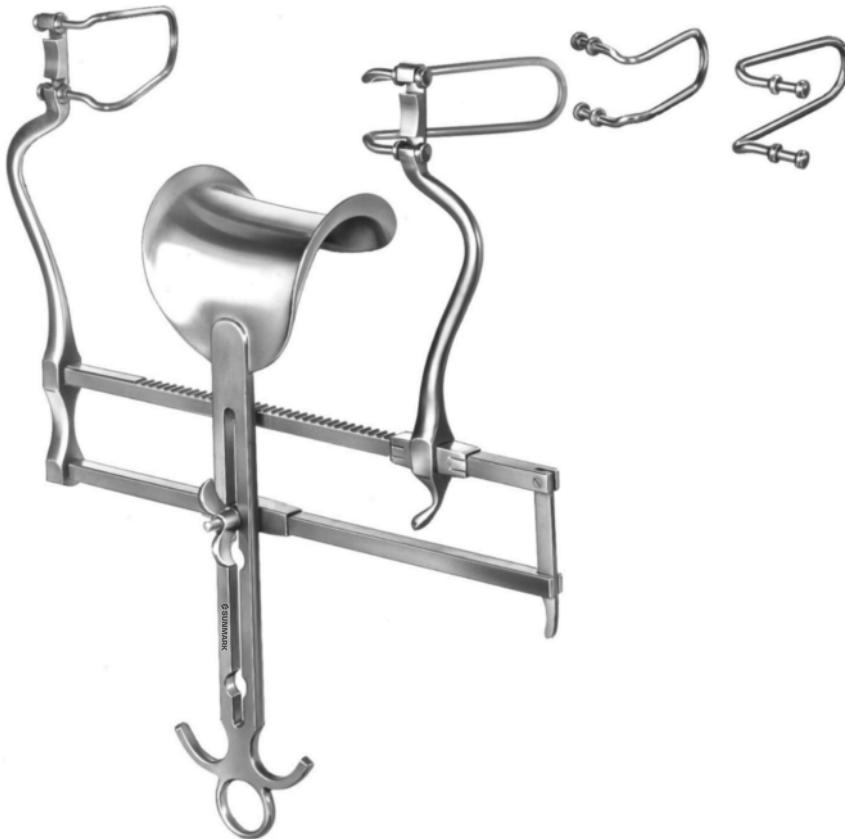

78-906-00

Balfour-Modell USA Retractor Complete

With 1 Pair Each of Lateral Blades Ref:- 78-906-06 and
78-906-08 and Central Blade 78-903-02

Spread 190 mm



78-906-06

60 mm Deep

78-906-08

80 mm Deep

Balfour-Modell USA Lateral Blade

Abdominal Retractors
 Bauchdeckenhalter
 Separadores abdominales
 Ecarteurs abdominaux
 Divaricatori addominali



78-910-00
Goligher Retractor Complete
 With Central Blades Ref:- 78-910-90
 and 78-910-91
 Spread 185 mm



78-910-05
 51 mm Deep
78-910-10
 102 mm Deep

Goligher Lateral Blade



78-910-90
 51 mm Deep
78-910-91
 102 mm Deep

Goligher Central Blade

Abdominal Retractors
Bauchdeckenhalter
Separadores abdominales
Ecarteurs abdominaux
Divaricatori addominali



78-914-00
Charnley Retractor Complete



78-914-90
Weight & Chain Charnley Retractor
Total 950 Grams



78-920-00
O'Sullivan-O'Connor Retractor Complete
With 2 Fixed Blades, 1 Blade Ref:- 78-910-91 and
2 Blades Ref:- 78-910-90



O'Sullivan-O'Connor Blade

78-920-90
80 x 45 mm

78-920-91
110 x 70 mm

Abdominal Retractors
Bauchdeckenhalter
Separadores abdominales
Ecarteurs abdominaux
Divaricatori addominali

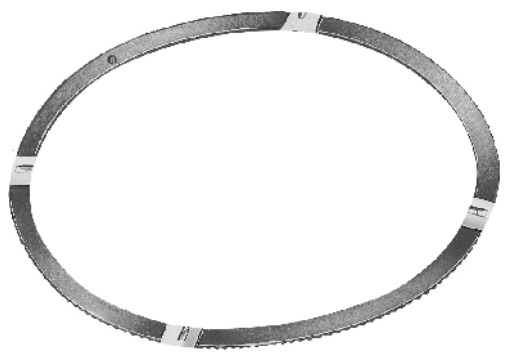
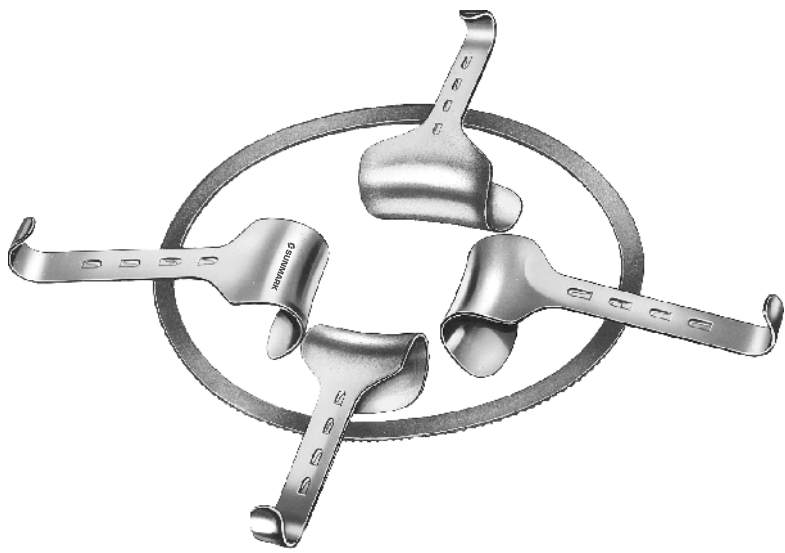

78-922-00
Kirschner Retractor Complete
With Frame 78-920-30, 3 Blades Ref:- 78-923-50 and
1 Blade Each of 78-923-80, 78-923-98 and 78-923-99

78-922-30
Kirschner Frame Only
340 x 240 mm



- 78-923-40**
40 x 55 mm
- 78-923-50**
50 x 65 mm
- 78-923-60**
60 x 85 mm
- 78-923-78**
78 x 65 mm
- 78-923-80**
80 x 90 mm

Kirschner Blade



- 78-923-98**
98 x 50 mm
- 78-923-99**
105 x 35 mm

Kirschner Blade



Abdominal Retractors
Bauchdeckenhalter
Separadores abdominales
Ecarteurs abdominaux
Divaricatori addominali

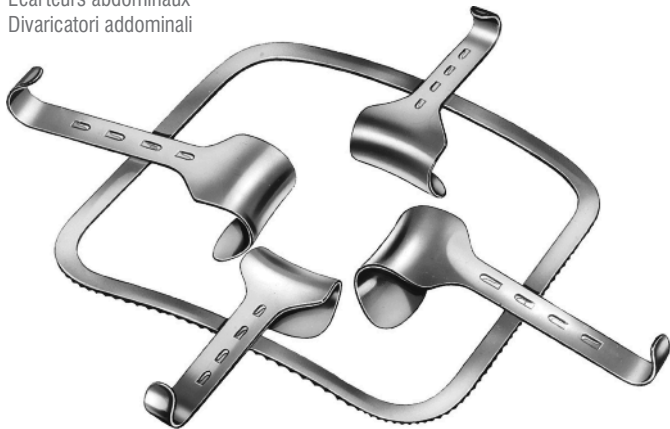

78-924-00
Kirshner Retractor Complete
With Frame 78-924-24, 2 Blades Ref:- 78-923-40
and 2 Blades Ref:- 78-923-50

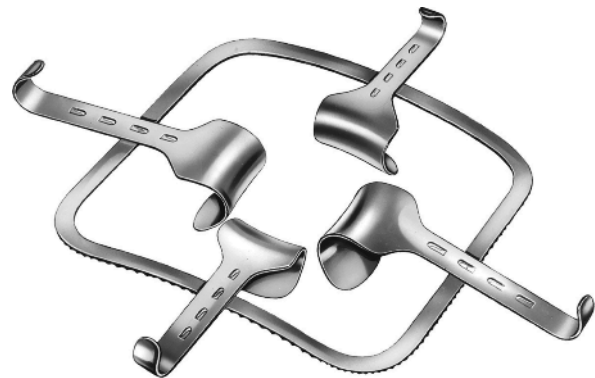

78-924-24
Kirshner Frame Only
240 x 240 mm

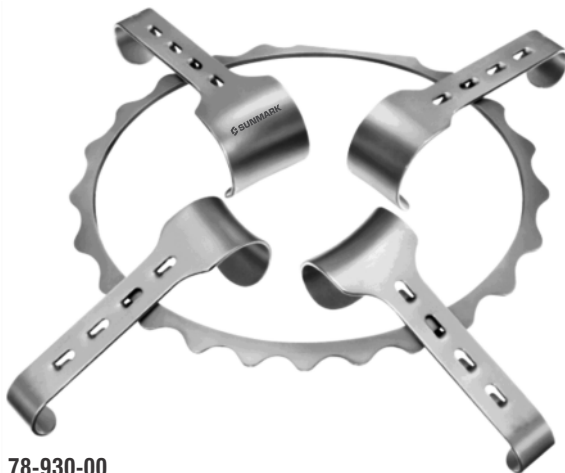

78-930-00
Dennis-Browne Retractor Complete
With Frame 78-930-15 & 2 Blades Each
Ref:- 78-930-30 and 78-930-40

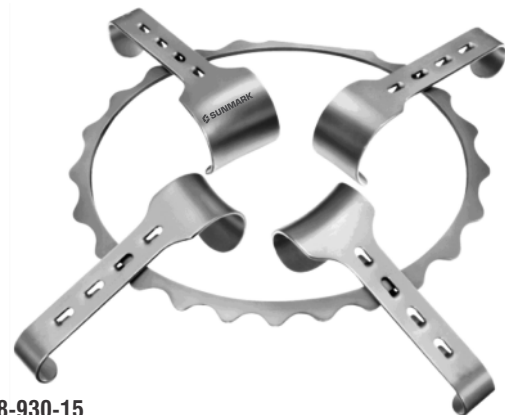

78-930-15
Dennis-Browne Retractor Frame Only
175 mm x 150 mm



78-930-30
40 mm x 30 mm

78-930-40
40 mm x 40 mm

Dennis-Browne Retractor Blade Only

Wound Spreaders, self-retaining
 Wundspreizer
 Separadores autoestáticos
 Ecarteurs autostatiques
 Divaricatori autostatici



78-940-00
Cloward Retractor Complete
 With 2 Each Lateral Blades Ref:- 78-941-40
 and 78-941-60



78-940-01
Cloward Retractor Only
 Overall Length 25 cm (9 3/4")



Cloward Lateral Blade
 Toothed

- | | |
|---------------------------|---------------------------|
| 78-941-40
40 mm | 78-941-55
55 mm |
| 78-941-45
45 mm | 78-941-60
60 mm |
| 78-941-50
50 mm | |

Wound Spreaders, self-retaining
 Wundspreizer
 Separadores autoestáticos
 Ecarteurs autostatiques
 Divaricatori autostatici



78-944-00
Cloward Retractor Complete
 Complete with 2 Lateral Blades 78-945-40
 and 78-945-60



78-944-01
Cloward Retractor Frame Only
 Overall Length 15 cm (6")



- | | |
|---------------------------|---------------------------|
| 78-945-40
40 mm | 78-945-55
55 mm |
| 78-945-45
45 mm | 78-945-60
60 mm |
| 78-945-50
50 mm | |

Cloward Lateral Blade

Laminectomy Retractors
Laminektomiesperrer
Separadores para laminectomia
Ecarteurs pour laminectomie
Divaricatori per laminectomia



78-950-00
Scoville Retractor Complete
With Lateral Blades Ref:- 78-953-06 and 78-953-11



78-950-01
Scoville Retractor Complete
Spread 150 mm



78-952-00
Scoville-Haverfield Retractor Complete
With Lateral Blades Ref:- 78-953-06
and 78-953-11



78-952-01
Scoville-Haverfield Retractor Frame Only
Hinged
Spread 150 mm

Laminectomy Retractors
 Laminektomiesperrer
 Separadores para laminectomía
 Ecarteurs pour laminectomie
 Divaricatori per laminectomia

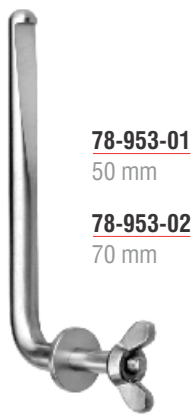

78-953-01
50 mm

78-953-02
70 mm

Scoville Lateral Blade
Blunt



78-953-01
50 mm

78-953-02
70 mm

Scoville Lateral Blade
Sharp



78-953-11
60 x 25 mm

78-953-12
64 x 50 mm

78-953-13
88 x 25 mm

Scoville Lateral Blade
Toothed



78-953-41
48 x 50 mm

78-953-42
60 x 50 mm

78-953-43
64 x 64 mm

78-953-44
80 x 57 mm

Taylor Lateral Blade
Sharp



78-953-46
41 x 38 mm

78-953-47
80 x 57 mm

Scoville Lateral Blade
Sharp



78-956-00
Scoville-Richter Retractor Complete
With Lateral Blades Pair Ref:- 78-957-01



78-956-01
Scoville-Richter Frame Only
Spread 155 mm

Laminectomy Retractors
Laminektomiesperr
Separadores para laminectomia
Ecarteurs pour laminectomie
Divaricatori per laminectomia



78-957-01
Lateral Blade Pair
62 x 52 mm, 62 x 37 mm



78-957-02
Lateral Blade
47 x 51 mm



78-957-03
Lateral Blade
30 x 40 mm



78-957-04
Lateral Blade
37 x 62 mm



78-960-00
Caspar Retractor Complete



78-960-01
Caspar Retractor Complete
With Key Ref: 78-960-02

Laminectomy Retractors
 Laminektomiesperrer
 Separadores para laminectomía
 Ecarteurs pour laminectomie
 Divaricatori per laminectomia



78-960-02
 Key For Caspar Retractor



78-961-01
 38 mm

78-961-02
 58 mm



78-961-03
 32 x 22 mm

78-961-07
 52 x 22 mm

78-961-04
 37 x 22 mm

78-961-08
 57 x 22 mm

78-961-05
 42 x 22 mm

78-961-09
 62 x 22 mm

78-961-06
 47 x 22 mm

78-961-10
 67 x 22 mm

Caspar Lateral Blade
 Blade With 2 Prongs



78-961-11
 32 x 37 mm

78-961-15
 52 x 37 mm

78-961-12
 37 x 37 mm

78-961-16
 57 x 37 mm

78-961-13
 42 x 37 mm

78-961-17
 62 x 37 mm

78-961-14
 47 x 37 mm

78-961-18
 67 x 37 mm

Caspar Lateral Blade
 Blade With 3 Prongs



78-961-19
 38 x 37 mm

78-961-23
 52 x 37 mm

78-961-20
 37 x 37 mm

78-961-24
 57 x 37 mm

78-961-21
 42 x 37 mm

78-961-25
 62 x 37 mm

78-961-22
 47 x 37 mm

78-961-26
 67 x 37 mm

Caspar Lateral Blade
 Blade With 4 Prongs

Laminectomy Retractors
Laminektomiesperrer
Separadores para laminectomia
Ecarteurs pour laminectomie
Divaricatori per laminectomia



78-973-16
Cloward Lamina Spreader
Overall Length 16 cm (6 1/4")



78-975-13
Cloward Lamina Spreader
Overall Length 13.5 cm (5 1/4")



78-977-17
16 cm (6 1/4")

78-979-27
25.5 cm (10")

Inge Lamina Spreader

Probes
 Knopfsonden
 Sondas abotonadas
 Sondes boutonnées
 Sonde a bottone



Overall Length	Ø 1.0 mm	Ø 1.5 mm	Ø 2.0 mm
11.5 cm (4 ½")	<u>77-010-11</u>	<u>77-015-11</u>	<u>77-020-11</u>
13 cm (5")	<u>77-010-13</u>	<u>77-015-13</u>	<u>77-020-13</u>
14.5 cm (5 ¾")	<u>77-010-14</u>	<u>77-015-14</u>	<u>77-020-14</u>
16 cm (6 ¼")	<u>77-010-16</u>	<u>77-015-16</u>	<u>77-020-16</u>
18 cm (7")	<u>77-010-18</u>	<u>77-015-18</u>	<u>77-020-18</u>
20 cm (8")	<u>77-010-20</u>	<u>77-015-20</u>	<u>77-020-20</u>
25 cm (9 ¾")		<u>77-015-25</u>	<u>77-020-25</u>
30 cm (11 ¾")			<u>77-020-30</u>

Probe



**Probe
 With Eye**

77-030-13

Ø 2 mm
 13 cm (5")

77-030-13

Ø 2 mm
 14.5 cm (5 ¾")

77-030-13

Ø 2 mm
 16 cm (6 ¼")



**77-040-10
 Stacke (Silver) Probe**
 Ø 1 mm
 Overall Length 10 cm (4")



**77-050-10
 Cawthron Probe**
 Flattened End
 Overall Length 14 cm (5 ½")



Myrtle Leaf Probe

77-070-13

Ø 2 mm
 13 cm (5")

77-070-14

Ø 2 mm
 14.5 cm (5 ¾")

77-070-16

Ø 2 mm
 16 cm (6 ¼")

77-070-18

Ø 2 mm
 18 cm (7")

77-070-20

Ø 2 mm
 20 cm (8")

Probes
Knopfsonden
Sondas abotonadas
Sondes boutonnées
Sonde a bottone



77-081-16
Killian Probe
Overall Length
16.5 cm (6 1/2")



77-083-16
Probe
Overall Length
16 cm (6 1/4")



77-086-35
Ochsner Gall Stone Probe
Overall Length 35 cm (13 3/4")



77-088-05
5.0 mm
77-088-06
6.0 mm
Mayo Common Duct Probe
Malleable
Overall Length 25.5 cm (10")



77-091-19
Seiffert Probe
Overall Length
19.5 cm (7 3/4")

Probes, Grooved Directors
Knopfsonden, Hohlsonden
Sondas abotonadas, Sondas acanaladas
Sondes boutonnées, Sondes cannelées
Sonde a bottone, Sonde cannellate



77-100-13
13 cm (5")

77-100-14
14 cm (5 1/2")

77-100-16
16 cm (6 1/4")

Butterfly Probe/Grooved Director



77-120-13
13 cm (5")

77-120-14
14.5 cm (5 3/4")

77-120-16
16 cm (6 1/4")

**Butterfly Probe/Grooved Director
With Tip**



77-131-14
Doyen Butterfly Probe/Grooved Director
Overall Length 14.5 cm (5 3/4")



77-141-16
Nelaton Butterfly Probe/Grooved Director
Overall Length 16 cm (6 1/4")



77-150-20
Brodie Butterfly Probe/Grooved Director
Ø 3.5 mm
Overall Length 20 cm (8")

Probes
 Knopfsonden
 Sondas abotonadas
 Sondes boutonées
 Sonde a bottone



77-200-00
Bowman Probes Complete
 Set of 6 Probes
 Overall Length 13 cm (5")



77-202-00
 Fig. 0000/000
 Tip Diameter
 0.4 mm - 0.5 mm

77-204-00
 Fig. 00/0
 Tip Diameter
 0.7 mm - 0.8 mm

77-204-12
 Fig. 1/2
 Tip Diameter
 0.9 mm - 1.1 mm

77-204-34
 Fig. 3/4
 Tip Diameter
 1.3 mm - 1.4 mm

77-204-56
 Fig. 5/6
 Tip Diameter
 1.5 mm - 1.6 mm

77-204-78
 Fig. 7/8
 Tip Diameter
 1.8 mm - 1.9 mm

Bowman Probes
 Overall Length 13 cm (5")

Varix Instruments
Varizeninstrumente
Instrumentos para varices
Instruments pour varices
Strumenti per varici



77-251-01
Lockha78-Mummery
Fistula Probe
Fig. 1
Overall Length 16.5 cm (6 1/2")



77-251-02
Lockha78-Mummery
Fistula Probe
Fig. 2
Overall Length 16.5 cm (6 1/2")



77-251-03
Lockha78-Mummery
Fistula Probe
Fig. 3
Overall Length 16.5 cm (6 1/2")



77-251-04
Lockha78-Mummery
Fistula Probe
Fig. 4
Overall Length 16.5 cm (6 1/2")

Varix Instruments
Varizeninstrumente
Instrumentos para varices
Instruments pour varices
Strumenti per varici



Pratt Fistula Probe
Overall Length 21 cm (8 1/4")

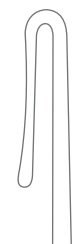

77-261-01
Fig. 1

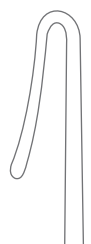

77-261-02
Fig. 2



77-261-03
Fig. 3



77-300-00
Nabatoff Varicose Vein Probes Complete Set



77-300-02



77-300-03
Ø 3 mm
Olive Shaped



77-300-06
Ø 6 mm
Olive Shaped



77-300-09
Ø 9 mm
Olive Shaped



77-300-12
Ø 12 mm
Olive Shaped



77-300-15
Ø 15 mm
Olive Shaped

Nabatoff Vein Probe

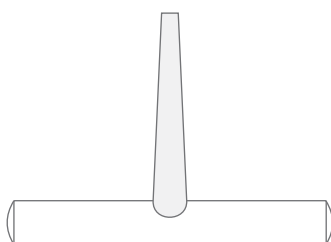

77-300-80
Nabatoff T Shaped Handle

Ring Strippers
 Ringstripper
 Fleboextractores
 Strippers à anneau
 Stripper anello

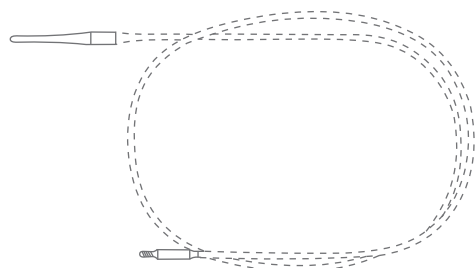

77-300-90
Nabatoff Traction Cable



77-400-11
Vollmar Handle
 Overall Length 11.5 cm (4 1/2")

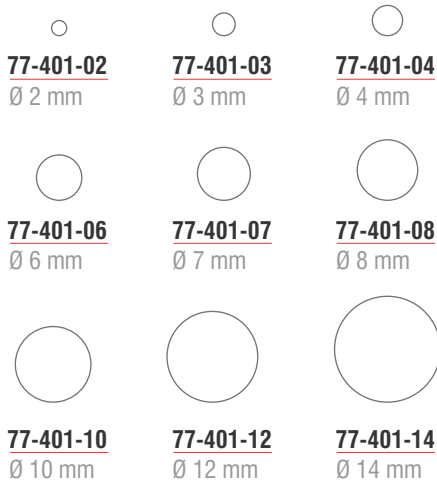

Vollmar Ring Stripper
 Overall Length 50 cm (19 3/4")



Farrell Cotton Applicator
 Round Spiral End

Probes
Knopfsonden
Sondas abotonadas
Sondes boutonnées
Sonde a bottone



Farrell Cotton Applicator
Triangular Shaped End

77-520-12

Ø 0.9 mm
12 cm (4 ¾")

77-520-14

Ø 0.9 mm
14 cm (5 ½")

77-520-16

Ø 1.1 mm
16 cm (6 ¼")

77-520-18

Ø 1.2 mm
18 cm (7")



Cotton Application
Round Spiral End
Overall Length 18 cm (7")

77-540-15

Ø 1.5 mm

77-520-14

Ø 1.8 mm



77-551-22
Hartmann Cotton Application
Round Spiral End, Ø 2.3 mm
Overall Length 22 cm (8 ½")



77-561-15
Jobson-Horne Ear Probe
Double Ended
Overall Length 15 cm (6")

Varix Instruments
Varizeninstrumente
Instrumentos para varices
Instruments pour varices
Strumenti per varici

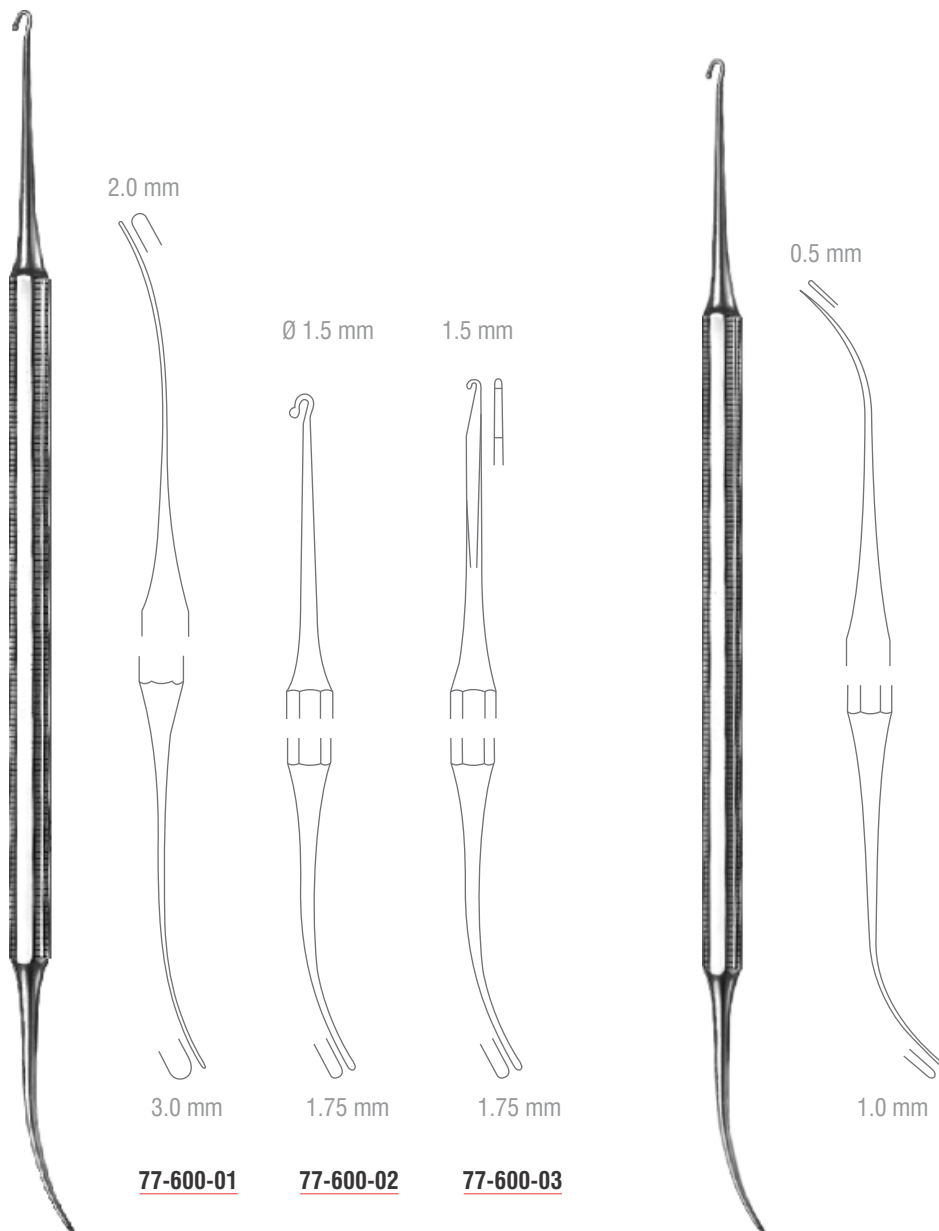

Varady Varix Instrument
Phlebodissector
Overall Length 18 cm (7")

77-600-04
Varady Varix Instrument
Micro Spatula
Overall Length 17.5 cm (7")

Varix Instruments
 Varizeninstrumente
 Instrumentos para varices
 Instruments pour varices
 Strumenti per varici

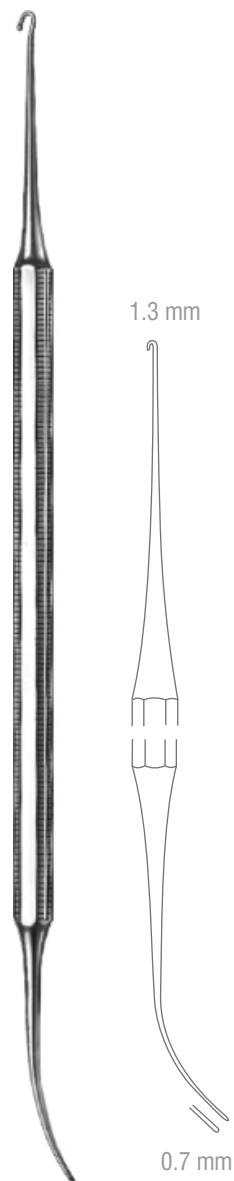

77-600-05
Varady Varix Instrument
 Micro Phleboextractor
 Overall Length 18 cm (7")

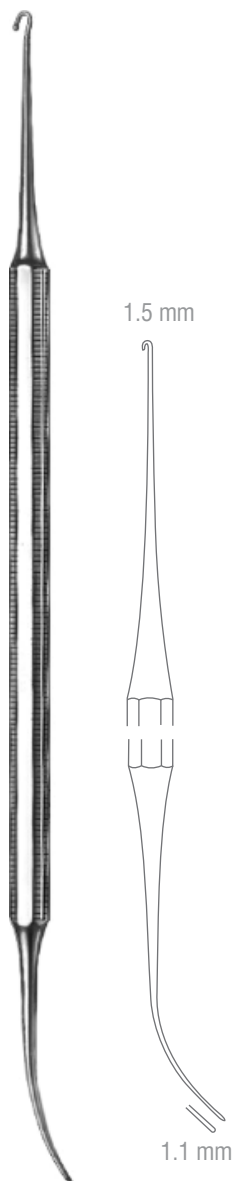

77-600-06
Varady Varix Instrument
 Mini Phleboextractor
 Overall Length 18 cm (7")

Percussion Hammers
 Perkussionshämmer
 Martillos para reflejos
 Marteaux-percuteurs
 Martelli percussori



34-100-18
Buck Percussion Hammer
 With Needle and Brush
 Overall Length 18.5 cm (7 ¼")



34-110-20
Dejerine Percussion Hammer
 Overall Length 20 cm (8")



34-112-21
Dejerine Percussion Hammer
 Overall Length 21 cm (8 ¼")

Percussion Hammers
Perkussionshämmer
Martillos para reflejos
Marteaux-percuteurs
Martelli percussori



34-120-20
Taylor Mod. USA Percussion Hammer
Overall Length 20 cm (8")



34-130-22
Babinsky Percussion Hammer
With Needle
Overall Length 22 cm (8 ¾")



34-132-23
Rabiner Percussion Hammer
Overall Length 23 cm (9")



Stethoscopes, Head Lamps
Stethoskope, Stirnlampen
Estetoscopios, Lámparas frontales
Stéthoscopes, Eclaireurs frontaux
Stetoscopi, Lampada frontale



34-210-19
Wartenberg Sensibility Instrument
Overall Length 19 cm (7 ½")



34-300-18
Pinard Stethoscope
Wood
Overall Length 18 cm (7")



34-310-15
Pinard Stethoscope
Aluminium
Overall Length 15 cm (6")



34-600-09
Ziegler Head Mirror
Without Protection Cap
Ø 90 mm



34-601-09
Ziegler Head Mirror
With Protection Cap
Ø 90 mm

Head Lamps
Stirnlampen
Lámparas frontales
Eclaireurs frontaux
Lampada frontale



34-611-06
Clar Head Light Complete
With Transformer
Ø 55 mm, 6 Volts



34-615-06
Clar Head Light Complete
With Transformer
Ø 100 mm, 6 Volts



34-651-06
Head Light
Xenon Light



Diagnostic Set
 Diagnostikbesteck
 Juego para Diagnóstico
 Jeu pour diagnostic
 Set per diagnostica



34-730-00
 Corona™ Premium EENT Diagnostic Set



34-732-00
 Corona™ Premium Otoscope



34-734-00
 Corona™ Premium Ophthalmoscope



34-740-00
 Apollo™ Standard Universal EENT Diagnostic Set



Diagnostic Set, Calipers
 Diagnostikbesteck, Meßzirkel
 Juego para Diagnóstico, Compases
 Jeu pour diagnostic, Compas
 Set per diagnostica, Compassi



34-742-00
 Apollo™ Standard Otoscope



34-744-00
 Apollo™ Standard Ophthalmoscope



34-750-00
 Apollo™ Standard Dermatoscope



34-801-00
 Jameson Caliper



34-805-11
 Townley Caliper
 Graduated in mm and inches
 Overall Length 11.5 cm (4 1/2")



34-831-03
 Vernier Caliper
 Graduated in mm and inches, 150 mm
 Overall Length 23.5 cm (9 1/4")

Calipers
Schieblehren
Calibres
Pieds à coulisse
Calibro



34-833-22
Vernier Caliper
Graduated in mm and inches, 145 mm
Overall Length 22.5 cm (8 ¾")



34-841-00
Boley Caliper
100 mm

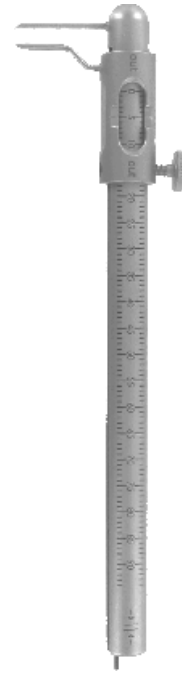

34-845-00
Measuring Caliper
100 mm



34-850-15
15 mm
8 cm (3")

34-850-20
20 mm
8 cm (3")

Castroviejo Caliper
Straight

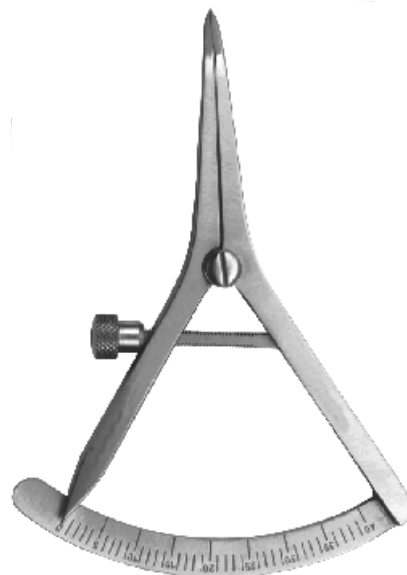

34-851-20
Castroviejo-Epker Caliper
20 mm
Overall Length 8 cm (3")

Calipers, Rulers
 Schieblehren, Maßstäbe
 Calibres, Reglas
 Pieds à coulisse, Règles à mesurer
 Calibro, Misuratori



Castroviejo Caliper
Curved

34-852-09
40 mm
9 cm (3 1/2")

34-852-18
40 mm
18 cm (7")



34-860-10
Iwanson Caliper
Straight
Overall Length 10 cm (4")



34-880-15
150 mm
10 cm (4")

34-852-18
300 mm
31.5 cm (12 1/2")

Ruler
Graduated in mm and inches

Trocars
Trokare
Trócares
Trocart
Trequarti



87-010-00
Universal Trocar
With 4 Trocar Tips Diameter 1.7 mm,
3.0 mm, 4.5 mm and 6.0 mm
Overall Length 14.5 cm (5 ¾")



87-020-07
Fig. 1
Ø 7.5 mm
22 Charr.

87-020-09
Fig. 2
Ø 9.5 mm
28 Charr.

87-020-11
Fig. 1
Ø 11.0 mm
33 Charr.

Nelson Trocar
22 FG
Overall Length 20 cm (8")



87-030-01
Ø 4 mm

87-030-02
Ø 4.6 mm

87-030-03
Ø 5.3 mm

87-030-04
Ø 6.0 mm

87-030-05
Ø 6.6 mm

87-030-06
Ø 7.3 mm

87-030-07
Ø 8.0 mm

87-030-08
Ø 8.6 mm

Ochsner Trocar
Overall Length 14 cm (5 ½")

Suction Tubes
Sauger
Tubos de aspiración
Tubes d'aspiration
Tubi d'aspirazione



Suction Tube



87-051-14
Ø 1.5 mm
14 cm (5 1/2")



87-053-14
Ø 2.5 mm
14 cm (5 1/2")



87-055-14
Ø 3.0 mm
14 cm (5 1/2")



87-057-14
Ø 4.0 mm
14 cm (5 1/2")



87-059-14
Ø 6.0 mm
14 cm (5 1/2")

87-051-18
Ø 1.5 mm
18 cm (7")

87-053-18
Ø 2.5 mm
18 cm (7")

87-055-18
Ø 3.0 mm
18 cm (7")

87-057-18
Ø 4.0 mm
18 cm (7")

87-059-18
Ø 6.0 mm
18 cm (7")



87-091-20
Adson Suction Tube
12 Charr. Ø 4.0 mm
Overall Length 20 cm (8")



87-094-24
Frazier Suction Tube
10 Charr. Ø 3.3 mm
Overall Length 24 cm (9 1/2")



Suction Tubes
 Sauger
 Tubos de aspiración
 Tubes d'aspiration
 Tubi d'aspirazione



87-101-06
 Ø 2.0 mm
 6 Charr.

87-101-07
 Ø 2.3 mm
 7 Charr.

87-101-08
 Ø 2.7 mm
 8 Charr.

87-101-09
 Ø 3.0 mm
 9 Charr.

87-101-10
 Ø 3.3 mm
 10 Charr.

87-101-11
 Ø 3.6 mm
 11 Charr.

87-101-12
 Ø 4.0 mm
 12 Charr.

87-101-15
 Ø 5.0 mm
 15 Charr.

Frazier Suction Tube
 Overall Length 19.5 cm (7 ¾")



87-111-05
 Ø 1.7 mm
 5 Charr.

87-111-06
 Ø 2.0 mm
 6 Charr.

87-111-08
 Ø 2.5 mm
 8 Charr.

87-111-09
 Ø 3.0 mm
 9 Charr.

87-111-12
 Ø 4.0 mm
 12 Charr.

87-111-15
 Ø 5.0 mm
 15 Charr.

Fergusson Suction Tube
 Overall Length 18 cm (7")

Suction Tubes
 Sauger
 Tubos de aspiración
 Tubes d'aspiration
 Tubi d'aspirazione



Working End Size	Overall Length							
	16.5 cm (6 1/2")	18 cm (7")	20.5 cm (8")	21 cm (8 1/4")	22 cm (8 3/4")	23 cm (9")	24 cm (9 1/2")	26.5 cm (10 1/2")
Ø 0.6 mm 2 Fr.	<u>87-113-02</u>	<u>87-115-02</u>	<u>87-117-02</u>	<u>87-120-02</u>	<u>87-122-02</u>	<u>87-119-02</u>	<u>87-124-02</u>	<u>87-126-02</u>
Ø 1.0 mm 3 Fr.	<u>87-113-03</u>	<u>87-115-03</u>	<u>87-117-03</u>	<u>87-120-03</u>	<u>87-122-03</u>	<u>87-119-03</u>	<u>87-124-03</u>	<u>87-126-03</u>
Ø 1.3 mm 4 Fr.	<u>87-113-04</u>	<u>87-115-04</u>	<u>87-117-04</u>	<u>87-120-04</u>	<u>87-122-04</u>	<u>87-119-04</u>	<u>87-124-04</u>	<u>87-126-04</u>
Ø 1.6 mm 5 Fr.	<u>87-113-05</u>	<u>87-115-05</u>	<u>87-117-05</u>	<u>87-120-05</u>	<u>87-122-05</u>	<u>87-119-05</u>	<u>87-124-05</u>	<u>87-126-05</u>
Ø 2.0 mm 6 Fr.	<u>87-113-06</u>	<u>87-115-06</u>	<u>87-117-06</u>	<u>87-120-06</u>	<u>87-122-06</u>	<u>87-119-06</u>	<u>87-124-06</u>	<u>87-126-06</u>
Ø 2.3 mm 7 Fr.	<u>87-113-07</u>	<u>87-115-07</u>	<u>87-117-07</u>	<u>87-120-07</u>	<u>87-122-07</u>	<u>87-119-07</u>	<u>87-124-07</u>	<u>87-126-07</u>
Ø 2.6 mm 8 Fr.	<u>87-113-08</u>	<u>87-115-08</u>	<u>87-117-08</u>	<u>87-120-08</u>	<u>87-122-08</u>	<u>87-119-08</u>	<u>87-124-08</u>	<u>87-126-08</u>
Ø 3.0 mm 9 Fr.	<u>87-113-09</u>	<u>87-115-09</u>	<u>87-117-09</u>	<u>87-120-09</u>	<u>87-122-09</u>	<u>87-119-09</u>	<u>87-124-09</u>	<u>87-126-09</u>
Ø 3.3 mm 10 Fr.	<u>87-113-10</u>	<u>87-115-10</u>	<u>87-117-10</u>	<u>87-120-10</u>	<u>87-122-10</u>	<u>87-119-10</u>	<u>87-124-10</u>	<u>87-126-10</u>
Ø 3.6 mm 11 Fr.	<u>87-113-11</u>	<u>87-115-11</u>	<u>87-117-11</u>	<u>87-120-11</u>	<u>87-122-11</u>	<u>87-119-11</u>	<u>87-124-11</u>	<u>87-126-11</u>
Ø 4.0 mm 12 Fr.	<u>87-113-12</u>	<u>87-115-12</u>	<u>87-117-12</u>	<u>87-120-12</u>	<u>87-122-12</u>	<u>87-119-12</u>	<u>87-124-12</u>	<u>87-126-12</u>

Fukushima Tear Drop Suction Tube
 Straight, Malleable

Suction Tubes
 Sauger
 Tubos de aspiración
 Tubes d'aspiration
 Tubi d'aspirazione



Fukushima Tear Drop Suction Tube
 Angled, Semi Rigid

Working End Size	Overall Length		
	21 cm (8 ¼")	23.5 cm (9 ¼")	26 cm (10 ¼")
Ø 0.6 mm 2 Fr.	<u>87-121-02</u>	<u>87-123-02</u>	<u>87-125-02</u>
Ø 1.0 mm 3 Fr.	<u>87-121-03</u>	<u>87-123-03</u>	<u>87-125-03</u>
Ø 1.3 mm 4 Fr.	<u>87-121-04</u>	<u>87-123-04</u>	<u>87-125-04</u>
Ø 1.6 mm 5 Fr.	<u>87-121-05</u>	<u>87-123-05</u>	<u>87-125-05</u>
Ø 2.0 mm 6 Fr.	<u>87-121-06</u>	<u>87-123-06</u>	<u>87-125-06</u>
Ø 2.3 mm 7 Fr.	<u>87-121-07</u>	<u>87-123-07</u>	<u>87-125-07</u>
Ø 2.6 mm 8 Fr.	<u>87-121-08</u>	<u>87-123-08</u>	<u>87-125-08</u>
Ø 3.0 mm 9 Fr.	<u>87-121-09</u>	<u>87-123-09</u>	<u>87-125-09</u>
Ø 3.3 mm 10 Fr.	<u>87-121-10</u>	<u>87-123-10</u>	<u>87-125-10</u>
Ø 3.6 mm 11 Fr.	<u>87-121-11</u>	<u>87-123-11</u>	<u>87-125-11</u>
Ø 4.0 mm 12 Fr.	<u>87-121-12</u>	<u>87-123-12</u>	<u>87-125-12</u>

Suction Tubes
 Sauger
 Tubos de aspiración
 Tubes d'aspiration
 Tubi d'aspirazione

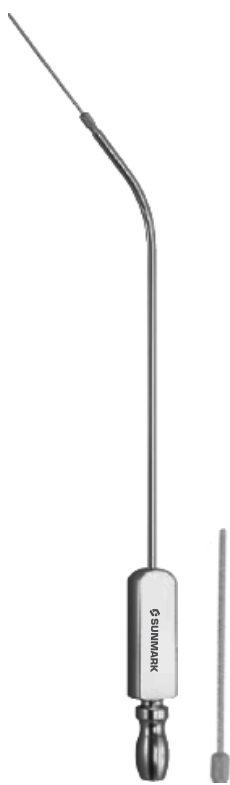

Zoellner Suction Tube Complete

87-131-00

Complete With Suction Tips

87-131-01

Suction Handle Only

87-132-05

Ø 0.5 mm

87-132-07

Ø 0.7 mm

87-132-09

Ø 0.9 mm

87-132-12

Ø 1.2 mm



Plester Suction Tube

With Grip Plate, Cut off Hole and Stylet
 Overall Length 20 cm (8")

87-135-05

Ø 1.7 mm
 5 Charr.

87-135-06

Ø 2.0 mm
 6 Charr.

87-135-07

Ø 2.3 mm
 7 Charr.

87-135-08

Ø 2.6 mm
 8 Charr.

87-135-09

Ø 3.0 mm
 9 Charr.



87-141-00

Wullstein Suction Tube Complete
 With Suction Handle and Micro
 Suction Tube Ref: 87-142-04,
 87-142-06, 87-142-08
 Overall Length 14 cm (5 1/2")



87-141-01

Wullstein Suction Tube Only
 Overall Length 14 cm (5 1/2")



87-142-04

Ø 0.4 mm

87-142-06

Ø 0.6 mm

87-142-08

Ø 0.8 mm

Wullstein Micro Suction Handle

Overall Length 4.5 cm (1 3/4")

Suction Tubes
Sauger
Tubos de aspiración
Tubes d'aspiration
Tubi d'aspirazione



- 87-151-10**
Ø 75 mm, 1.0 mm
- 87-151-10**
Ø 75 mm, 1.5 mm
- 87-151-10**
Ø 75 mm, 2.0 mm

Baron-Schuknecht Suction Handle
With Finger Cut Off



87-180-00
House Suction Adapter
With Finger Cut Off



- 87-185-05**
Ø 0.5 mm
- 87-185-07**
Ø 0.5 mm
- 87-185-10**
Ø 0.5 mm
- 87-185-12**
Ø 0.5 mm
- 87-185-15**
Ø 1.5 mm

Verhoeven Suction Cannula
With Luer Cone



- 87-191-09**
Ø 0.9 mm, 0.7 mm
- 87-191-12**
Ø 1.2 mm, 0.9 mm
- 87-191-15**
Ø 1.5 mm, 1.2 mm

House Suction Tube
With Finger Cutt Off

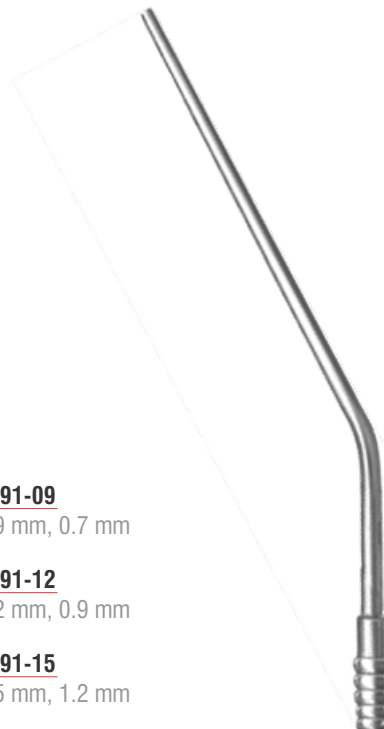

- 87-201-30**
Ø 110 mm, 3.0 mm
- 87-201-35**
Ø 110 mm, 3.5 mm
- 87-201-45**
Ø 110 mm, 4.5 mm

Luer Suction Tube

Suction Tubes
 Sauger
 Tubos de aspiración
 Tubes d'aspiration
 Tubi d'aspirazione

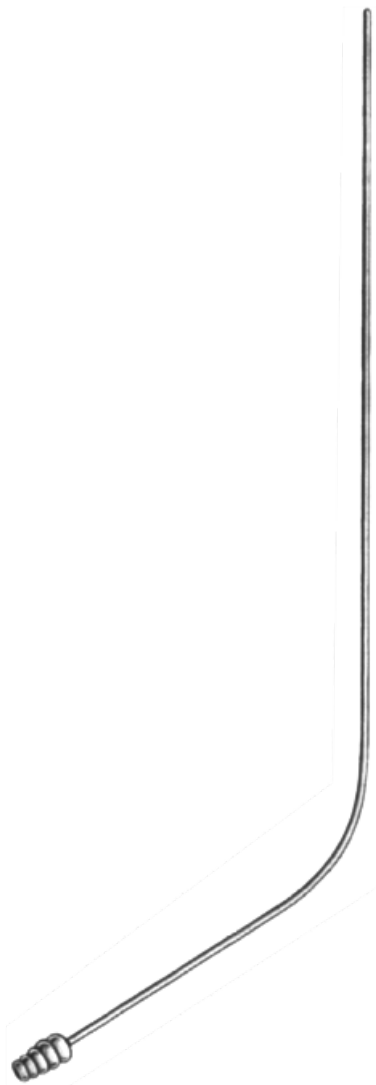

Yasargil Suction Tube
 With Luer Hub

<u>87-221-15</u> Ø 130 mm, 1.5 mm	<u>87-221-20</u> Ø 130 mm, 2.0 mm	<u>87-221-25</u> Ø 130 mm, 2.5 mm	<u>87-221-35</u> Ø 130 mm, 3.5 mm
<u>87-223-15</u> Ø 150 mm, 1.5 mm	<u>87-223-20</u> Ø 150 mm, 2.0 mm	<u>87-223-25</u> Ø 150 mm, 2.5 mm	<u>87-223-35</u> Ø 150 mm, 3.5 mm
<u>87-225-15</u> Ø 180 mm, 1.5 mm	<u>87-225-20</u> Ø 180 mm, 2.0 mm	<u>87-225-25</u> Ø 180 mm, 2.5 mm	<u>87-225-35</u> Ø 180 mm, 3.5 mm
<u>87-227-15</u> Ø 220 mm, 1.5 mm	<u>87-227-20</u> Ø 220 mm, 2.0 mm	<u>87-227-25</u> Ø 220 mm, 2.5 mm	<u>87-227-35</u> Ø 220 mm, 3.5 mm

Suction Tubes
 Sauger
 Tubos de aspiración
 Tubes d'aspiration
 Tubi d'aspirazione



87-241-04
 4.0 mm

87-241-05
 5.0 mm

Suction Raspatory
 Sharp, Bayonet Shaped
 Overall Length 20 cm (8")



87-243-32
Landolt Dissecting Suction Tube
 Sharp, 3.2 mm
 Overall Length 20 cm (8")



87-245-23
Andrews-Pynchon Suction Tube (Complete)
 Ø 2.0 mm
 Overall Length 23 cm (9")



87-247-01
 Ø 3.0 mm
 21 cm (8 1/4")

87-247-02
 Ø 4.0 mm
 22.5 cm (8 3/4")

87-247-03
 Ø 4.0 mm
 24.5 cm (9 1/2")

Morse-Andrews Suction Tube

Suction Tubes
Sauger
Tubos de aspiración
Tubes d'aspiration
Tubi d'aspirazione



87-251-27
Yankauer Suction Tube (Complete)
Central Bore, 2.0 mm
Overall Length 31 cm (12 1/4")



87-251-27 FO
Yankauer Suction Tube (With Fiber Optic Carrier Complete)
Central Bore, 2.0 mm
Overall Length 31 cm (12 1/4")



87-253-27
Yankauer Suction Tube (Complete)
Central Bore, 4.8 mm
Overall Length 31 cm (12 1/4")

Suction Tubes
 Sauger
 Tubos de aspiración
 Tubes d'aspiration
 Tubi d'aspirazione



87-255-00
Yankauer Suction Tube Complete (Detachable)
 With Handle, 4 Tube, Suction Tip and Tube Connector
 Overall Length 31 cm (21 1/4")



87-255-01
Yankauer Suction Handle Only
 Overall Length 15 cm (6")



87-255-02
Yankauer Suction Connector Only
 Oval Shaped
 Overall Length 2.5 cm (1")



87-255-10
Yankauer Suction Tube
 Fig. 0
 Overall Length 10 cm (4")



87-255-11
Yankauer Suction Tube
 Fig. 1
 Overall Length 10 cm (4")



87-255-12
Yankauer Suction Tube
 Fig. 2
 Overall Length 10 cm (4")

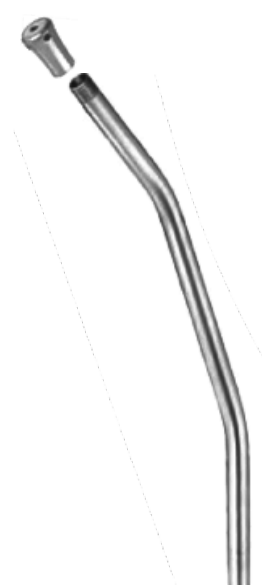

87-255-13
Yankauer Suction Tube
 Fig. 3
 Overall Length 13.5 cm (5 1/4")



87-255-15
Yankauer Suction Tip

Suction Tubes
 Sauger
 Tubos de aspiración
 Tubes d'aspiration
 Tubi d'aspirazione



87-270-22
Poole Suction Tube
 Ø 10.0 mm
 Overall Length 22 cm (8 ¾")



87-271-22
Poole Suction Tube
 Ø 8.0 mm
 Overall Length 22.5 cm (8 ¾")



87-273-20
Poole-Baby Suction Tube
 Ø 5.5 mm
 Overall Length 22 cm (8")



87-281-35
Cooley Suction Tube
 Ø 8.0 mm
 Overall Length 36 cm (14 ¼")

Suction Tubes
 Sauger
 Tubos de aspiración
 Tubes d'aspiration
 Tubi d'aspirazione



87-283-31
Cooley Suction Tube
 Ø 10.0 mm
 With Perforated Screw Tip
 Overall Length 31 cm (12 ¼")



87-285-30
Cooley Suction Tube
 Ø 7.0 mm
 With Perforated Screw Tip
 Overall Length 31 cm (12 ¼")



87-287-33
Cooley Suction Tube
 Ø 8.0 mm
 With Perforated Screw Tip
 Overall Length 36 cm (12 ¼")



87-291-27
DeBakey Suction Tube
 Ø 9.0 mm
 Overall Length 27.5 cm (12 ¼")



87-293-16
 Ø 5.0 mm, Ø 9.0 mm
 16 cm (6 ¼")

DeBakey Suction Tube

87-293-27
 Ø 5.0 mm, Ø 9.0 mm
 27 cm (10 ¾")



87-301-32
Finsterer Suction Tube
 Ø 15.0 mm
 Overall Length 32 cm (12 ¾")

Suction Tubes
Sauger
Tubos de aspiración
Tubes d'aspiration
Tubi d'aspirazione



87-311-21
Nuboer Suction Tube
Round Opening, Ø 6.0 mm
Overall Length 21 cm (8 1/4")



87-313-21
Nuboer Suction Tube
Oval Opening, Ø 6.0 mm
Overall Length 21 cm (8 1/4")



87-321-00
Coupland Suction Tube Complete
With Suction Tips Ref: 87-323-05 to
87-323-08



87-322-24
Nuboer Suction Tube
With Tube Connector
Overall Length 17 cm (6 3/4")



87-323-05
Ø 1.5 mm

87-323-06
Ø 2.0 mm

87-323-07
Ø 2.5 mm

87-323-08
Ø 3.5 mm

Coupland Suction Tip
Laterally Perforated
Overall Length 9 cm (3 1/2")

Suction Tubes, Special Needles
 Sauger, Spezialkanülen
 Tubos de aspiración, Agujas especiales
 Tubes d'aspiration, Aiguilles spéciales
 Tubi d'aspirazione, Aghi speciali



Byrd Suction Tube
 Overall Length 21.5 cm (8 1/2")

87-341-30
 Ø 3.0 mm

87-341-38
 Ø 2.5 mm

87-341-43
 Ø 3.5 mm



87-345-23
Cogswell Suction Tube
 With Finger Cutt Off
 Overall Length 24.5 cm (9 3/4")



87-400-00
Hypodermic Needle
 Set of 7 Ref: 87-602-01 Up
 to 87-602-20
 Overall Length 24.5 cm (9 3/4")



Hypodermic Needle

87-400-01

Fig. 1
 0.85 x 40 mm

87-400-02

Fig. 2
 0.80 x 35 mm

87-400-12

Fig. 12
 0.70 x 32 mm

87-400-14

Fig. 14
 0.65 x 30 mm

87-400-16

Fig. 16
 0.60 x 25 mm

87-400-18

Fig. 18
 0.50 x 23 mm

87-400-20

Fig. 20
 0.45 x 18 mm

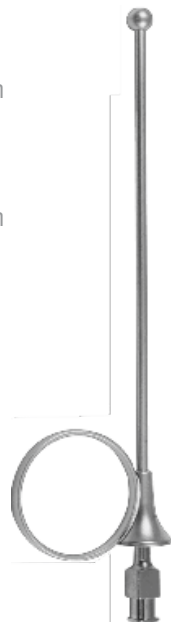

87-410-00
Pudendus Anaesthesia Needle
 Ø 1.0 x 185 mm
 Complete With Cannula
 Overall Length 18 cm (7")



87-420-12
 Ø 1.2 x 80 mm

87-420-15
 Ø 1.5 x 80 mm

Vein Cannula
 Button End, With Tube Connector

Special Needles
Spezialkanülen
Agujas especiales
Aiguilles spéciales
Aghi speciali

Special Needles
Spezialkanülen
Agujas especiales
Aiguilles spéciales
Aghi speciali

87-450-10
Ø 1.2 x 76 mm

87-450-12
Ø 1.2 x 89 mm

87-450-14
Ø 1.0 x 76 mm

87-450-16
Ø 1.0 x 89 mm

87-450-18
Ø 0.7 x 76 mm

87-450-19
Ø 0.7 x 50 mm

87-450-20
Ø 0.7 x 89 mm



Quinke Lumbar Puncture Needle
18 G, 19 G, 22 G, With Luer Lock Connection



Tuohy Lumbar Puncture Needle
18 G, 17 G, 16 G, With Luer Lock Connection, Special Tip

87-460-12
Ø 1.2 x 76 mm

87-460-14
Ø 1.4 x 76 mm

87-460-16
Ø 1.4 x 35 mm



87-464-13
Abrams Pleural Biopsy Needle Set
Ø 4.0 mm
Overall Length 13.5 cm (5 1/2")



Menghini Liver Puncture Needle
Blind Lever Puncture, With Stopping Needle

87-470-10
Ø 1.0 x 35 mm

87-470-25
Ø 1.2 x 100 mm

87-470-40
Ø 1.6 x 70 mm

87-470-15
Ø 1.0 x 70 mm

87-470-30
Ø 1.4 x 70 mm

87-470-50
Ø 1.8 x 100 mm

87-470-20
Ø 1.2 x 70 mm

87-470-35
Ø 1.4 x 100 mm



Special Needles
Spezialkanülen
Agujas especiales
Aiguilles spéciales
Aghi speciali



87-472-14
Ø 1.0 x 35 mm

87-472-18
Ø 1.8 x 168 mm

Menghini Liver Puncture Needle
For Controlled Blind Liver Puncture



87-480-15
Ø 1.5 x 90 mm

87-480-18
Ø 1.8 x 90 mm

87-480-20
Ø 2.0 x 90 mm

Lichtwitz Antrum Puncture Needle



87-490-10
Tonsil Needle
Ø 0.65 mm
Tapered Tip With Luer Lock Connection



87-491-15
Tonsil Needle
Ø 0.65 mm
Tapered Tip With Luer Lock Connection



87-493-20
Tonsil Needle
Ø 0.65 mm
Tapered Tip With Luer Lock Connection

Vessel Irrigation Cannulas
Gefäß-Spülkanülen
Cánulas para irrigación vascular
Canules pour irrigation vasculaire
Cannule per irrigazione vascolare



87-500-20
Verres Insufflation Cannula
With Luer Lock Connection
Ø 2.0 x 100 mm



87-502-20
Verres Insufflation Cannula
With Luer Lock Connection
Ø 2.0 x 120 mm



87-520-15 **87-520-20**
Ø 1.5 mm Ø 2.0 mm

87-520-25 **87-520-30**
Ø 2.5 mm Ø 3.0 mm

87-520-40
Ø 4.0 mm

Vollmar Vessel Irrigation Cannula
With Luer Lock Connection
Overall Length 6 cm (2 ¼")



Schmid Vessel Irrigation Cannula
Malleable, With Luer Lock Connection
Overall Length 15 cm (6")



87-530-03
Ø 3.0 mm

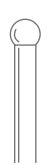

87-530-04
Ø 4.0 mm



87-530-05
Ø 5.0 mm



87-530-06
Ø 6.0 mm



87-536-30
Abraham Laryngeal Cannula
Malleable, With Luer Lock Connection
Ø 3.0 mm
Overall Length 15 cm (6")

Special Needles, Suction Cannulas
Spezialkanülen, Saugrohre
Agujas especiales, Tubos de aspiración
Aiguilles spéciales, Tubes d'aspiration
Aghi speciali, Tubi d'aspirazione



87-548-05
DeBakey Heparin Cannula
With Luer Lock Connection
Ø 5.0 mm
Overall Length 16 cm (6 ¼")



87-550-08
Ø 2.9 mm x
0.8 mm

87-550-10
Ø 2.9 mm x
0.8 mm

Mock Heparin Flushing Needle
Button End With Luer Lock
Connection
Overall Length 6.5 cm (2 ½")



87-552-09
Frazier Ventricular Cannula
Graduated in centimeters
Ø 2.6 mm
Overall Length 9 cm (3 ½")



87-554-12
With 1 Hole
Ø 1.2 mm

87-554-16
With 1 Hole
Ø 1.6 mm

87-554-12
With 2 Hole
Ø 1.2 mm

87-554-16
With 2 Hole
Ø 1.6 mm

Frazier Ventricular Cannula
Overall Length 9 cm (3 ½")

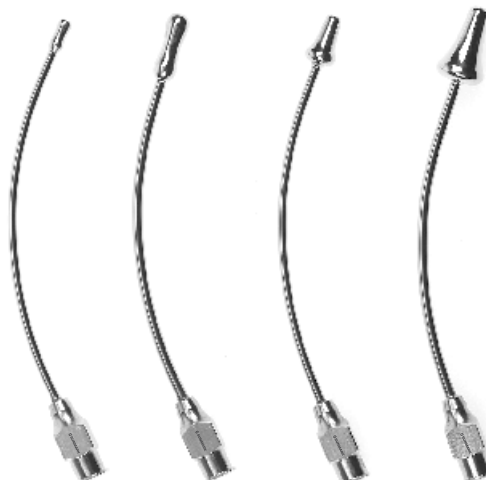

87-560-00
Tibbs Arterial Cannula Set



Hypodermic Syringe
 Gefäßclips, Approximatoren
 Clips vasculares, Aproximadores
 Clips vasculaires, Approximateurs
 Clip vascolari, Approssimatori



87-600-02
2.0 ml

87-600-05
5.0 ml

87-600-10
10.0 ml

3 Ring Hypodermic Syringe
 Glass Barrel, With Luer Lock
 Connection, Moveable Rings



87-610-05
50 ml

87-610-10
100 ml

87-610-05
150 ml

87-610-05
200 ml

Janet Wound and Bladder Syringe
 Glass Barrel, With 2 Exchangeable Tips

Guide Needles
 Führungsadeln
 Agujas de guía
 Aiguilles d'introduction
 Aghi conduttori

87-701-08

2.7 mm - 8 Charr.

87-701-12

4.0 mm - 12 Charr.

87-701-16

5.3 mm - 16 Charr.

87-701-10

3.3 mm - 10 Charr.

87-701-14

4.7 mm - 14 Charr.

87-701-18

6 mm - 18 Charr.

Redon Guide Needle

Knife Tip

Overall Length 19.5 cm (7 ¾")

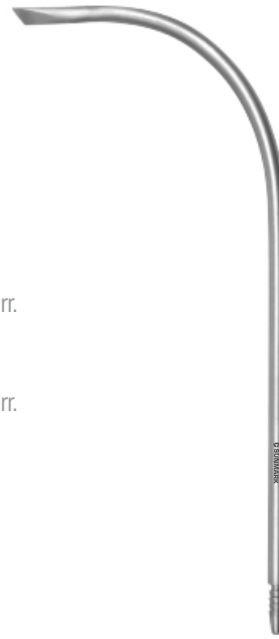
87-703-08

2.7 mm - 8 Charr.

87-703-12

4.0 mm - 12 Charr.

87-703-16

5.3 mm - 16 Charr.

87-703-10

3.3 mm - 10 Charr.

87-703-14

4.7 mm - 14 Charr.

87-703-18

6 mm - 18 Charr.

Redon Guide Needle

Knife Tip

Overall Length 19.5 cm (7 ¾")

87-705-08

2.7 mm - 8 Charr.

87-705-12

4.0 mm - 12 Charr.

87-705-16

5.3 mm - 16 Charr.

87-705-10

3.3 mm - 10 Charr.

87-705-14

4.7 mm - 14 Charr.

87-705-18

6 mm - 18 Charr.

Redon Guide Needle

Lancet Tip

Overall Length 19.5 cm (7 ¾")

87-707-08

2.7 mm - 8 Charr.

87-707-12

4.0 mm - 12 Charr.

87-707-16

5.3 mm - 16 Charr.

87-707-10

3.3 mm - 10 Charr.

87-707-14

4.7 mm - 14 Charr.

87-707-18

6 mm - 18 Charr.

Redon Guide Needle

Trocar Tip

Overall Length 19.5 cm (7 ¾")

Catheter Introducing Forceps
 Kathetereinführzangen
 Pinzas para catéteres
 Pincas pour introduire les sondes
 Pinze per introdurre le sonde

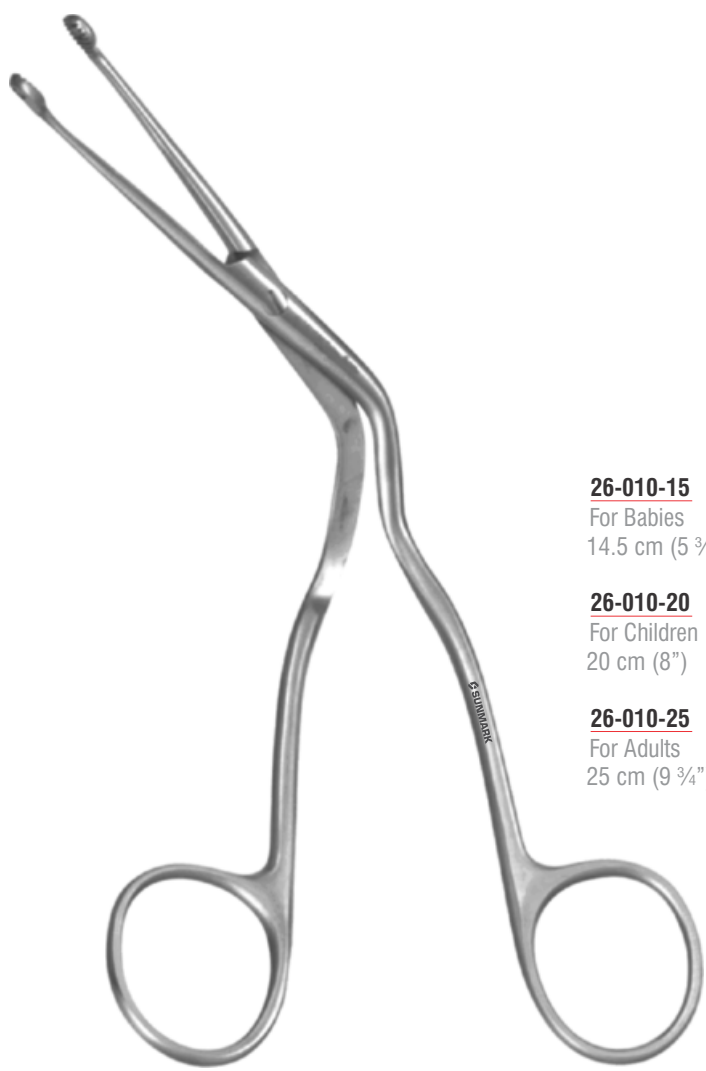

- 26-010-15**
For Babies
14.5 cm (5 ¾")
- 26-010-20**
For Children
20 cm (8")
- 26-010-25**
For Adults
25 cm (9 ¾")

Magill Catheter Introducing Forcep

Laryngoscopes and Accessories
Laryngoskope und Zubehör
Laringoscopios y accesorios
Laryngoscopes et accessoires
Laringoscopi ed accessori



Apollo™ Standard Miller-Baby Laryngoscope Set

26-100-00

With Battery Handle
Ref: 26-290-01 and
2 Blades Ref: 26-110-00
to 26-110-01

26-101-00

With Battery Handle
Ref: 26-290-01 and
3 Blades Ref: 26-110-01
to 26-110-03

26-102-00

With Battery Handle
Ref: 26-290-01 and
4 Blades Ref: 26-110-01
to 26-110-04

26-103-00

With Battery Handle
Ref: 26-290-01 and
5 Blades Ref: 26-110-00
to 26-110-04



26-110-00

Fig. 0
55 mm, For Babies

26-110-01

Fig. 1
80 mm, For Children

26-110-02

Fig. 2
130 mm, Adolescents

26-110-03

Fig. 3
170 mm, For Women

26-110-04

Fig. 4
180 mm, For Men

Apollo™ Standard Miller Laryngoscope Blade

Laryngoscopes and Accessories
Laryngoskope und Zubehör
Laringoscopios y accesorios
Laryngoscopes et accessoires
Laringoscopi ed accessori



Apollo™ Standard McIntosh-Baby Laryngoscope Set



26-210-00
Fig. 0
55 mm, For Babies

26-210-01
Fig. 1
75 mm, For Children

26-210-02
Fig. 2
90 mm, Adolescents

26-210-03
Fig. 3
110 mm, For Women

26-210-04
Fig. 4
135 mm, For Men

Apollo™ Standard Miller Laryngoscope Blade



26-290-01
Apollo™ Standard Battery Handle
Chrome Plated



26-294-01
For Blades Fig. 2 to 4
26-294-02
For Blades Fig. 0 to 1

Apollo™ Standard Spare Bulb Large



Laryngoscopes and Accessories
 Laryngoskope und Zubehör
 Laringoscopios y accesorios
 Laryngoscopes et accessoires
 Laringoscopi ed accessori

26-400-00

With Battery Handle
 Ref: 26-590-01 and
 2 Blades Ref: 26-410-00
 to 26-410-01

26-402-00

With Battery Handle
 Ref: 26-590-01 and
 4 Blades Ref: 26-410-01
 to 26-410-04

26-401-00

With Battery Handle
 Ref: 26-590-01 and
 3 Blades Ref: 26-410-01
 to 26-410-03

26-403-00

With Battery Handle
 Ref: 26-590-01 and
 5 Blades Ref: 26-410-00
 to 26-410-04

Corona™ Premium Fibre Optic McIntosh-Baby Laryngoscope Set

26-410-00

Fig. 0
 55 mm, For Babies

26-410-01

Fig. 1
 70 mm, For Children

26-410-02

Fig. 2
 80 mm, Adolescents

26-410-03

Fig. 3
 105 mm, For Women

26-410-04

Fig. 4
 130 mm, For Men

Corona™ Premium Fibre Optic McIntosh Laryngoscope Blade

Laryngoscopes and Accessories
Laryngoskope und Zubehör
Laringoscopios y accesorios
Laryngoscopes et accessoires
Laringoscopi ed accessori



Corona™ Premium Fibre Optic Miller-Baby Laryngoscope Set



26-510-00

Fig. 0
55 mm, For Babies

26-510-01

Fig. 1
80 mm, For Children

26-510-02

Fig. 2
130 mm, Adolescents

26-510-03

Fig. 3
170 mm, For Women

26-510-04

Fig. 4
180 mm, For Men

Corona™ Premium Fibre Optic McIntosh Laryngoscope Blade



26-500-00

With Battery Handle
Ref: 26-590-01 and
2 Blades Ref: 26-510-00
to 26-510-01

26-501-00

With Battery Handle
Ref: 26-590-01 and
3 Blades Ref: 26-510-01
to 26-510-03

26-502-00

With Battery Handle
Ref: 26-590-01 and
4 Blades Ref: 26-410-01
to 26-410-04

26-503-00

With Battery Handle
Ref: 26-590-01 and
5 Blades Ref: 26-510-00
to 26-510-04

Laryngoscopes and Accessories
 Laryngoskope und Zubehör
 Laringoscopios y accesorios
 Laryngoscopes et accessoires
 Laringoscopi ed accessori



26-590-01
Corona™ Premium Fibre Optic Battery Handle
 With 2.5 Volts Xenon Bulb



26-592-02
Corona™ Premium Fibre Optic Battery Handle
 Slim Profile, With 2.5 Volts Xenon Bulb



26-594-01
Corona™ Premium Fibre Optic Spare Bulb
 Xenon, 2.5 V



Laryngoscopes and Accessories
 Laryngoskope und Zubehör
 Laringoscopios y accesorios
 Laryngoscopes et accessoires
 Laringoscopi ed accessori



26-700-00

With Battery Handle
 Ref: 26-890-01 and
 2 Blades Ref: 26-710-00
 to 26-710-01

26-702-00

With Battery Handle
 Ref: 26-890-01 and
 4 Blades Ref: 26-710-01
 to 26-710-04

26-701-00

With Battery Handle
 Ref: 26-890-01 and
 3 Blades Ref: 26-710-01
 to 26-710-03

26-703-00

With Battery Handle
 Ref: 26-890-01 and
 5 Blades Ref: 26-710-00
 to 26-710-04

MaxBright™ LED Fibre Optic McIntosh-Baby Laryngoscope Set



26-710-00

Fig. 0
 55 mm, For Babies

26-710-01

Fig. 1
 70 mm, For Children

26-710-02

Fig. 2
 80 mm, Adolescents

26-710-03

Fig. 3
 105 mm, For Women

26-710-04

Fig. 4
 130 mm, For Men

MaxBright™ LED Fibre Optic McIntosh Laryngoscope Blade



Laryngoscopes and Accessories
 Laryngoskope und Zubehör
 Laringoscopios y accesorios
 Laryngoscopes et accessoires
 Laringoscopi ed accessori



MaxBright™ Fibre Optic Miller-Baby Laryngoscope Set

26-800-00

With Battery Handle
 Ref: 26-890-01 and
 2 Blades Ref: 26-810-00
 to 26-810-01

26-802-00

With Battery Handle
 Ref: 26-890-01 and
 4 Blades Ref: 26-810-01
 to 26-810-04

26-801-00

With Battery Handle
 Ref: 26-890-01 and
 3 Blades Ref: 26-810-01
 to 26-810-03

26-803-00

With Battery Handle
 Ref: 26-890-01 and
 5 Blades Ref: 26-810-00
 to 26-810-04



26-810-00

Fig. 0
 55 mm, For Babies

26-810-01

Fig. 1
 80 mm, For Children

26-810-02

Fig. 2
 130 mm, Adolescents

26-810-03

Fig. 3
 170 mm, For Women

26-810-04

Fig. 4
 180 mm, For Men

MaxBright™ LED Fibre Optic McIntosh Laryngoscope Blade



Laryngoscopes and Accessories
Laryngoskope und Zubehör
Laringoscopios y accesorios
Laryngoscopes et accessoires
Laringoscopi ed accessori



26-890-01
MaxBright™ Fibre Optic Battery Handle
With 2.5 Volts LED Bulb



26-892-02
MaxBright™ Fibre Optic Battery Handle
Slim Profile, With 2.5 Volts LED Bulb



26-894-01
MaxBright™ LED Fibre Optic Spare Bulb
Xenon, 2.5 V



Needle Holders
Nadelhalter
Porta-agujas
Porte-aiguilles
Portaghi



78-010-12
Derf Needle Holder
One Fenestrated Jaw
Overall Length 12 cm (4 3/4")



78-012-12
Converse Needle Holder
Jaw With Longitudinal Serrations
Overall Length 13 cm (5")



78-016-12
Collier Needle Holder
One Grooved Jaws
Overall Length 12.5 cm (5")



78-020-13
Webster Needle Holder
Smooth Jaws
Overall Length 13 cm (5")

Needle Holders
Nadelhalter
Porta-agujas
Porte-aiguilles
Portaghi



78-024-13
Smooth Jaws

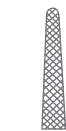

78-026-13
Serrated Jaws



78-029-13
Kilner Needle Holder
Overall Length 13.5 cm (5 1/4")



78-032-13
Nevert Needle Holder
Smooth Jaws With Special Groove
Overall Length 12.5 cm (5")



78-034-13
Doyen Needle Holder
Overall Length 12.5 cm (5")

Needle Holders
Nadelhalter
Porta-agujas
Porte-aiguilles
Portaghi



78-038-14
Hegar-Baumgartner Needle Holder
Overall Length 14.5 cm (5 ¾")



78-040-13
13 cm (5")

78-040-18
18 cm (7")

Brown Needle Holder
Heavy Pattern



78-042-15
Lawrence Needle Holder
Overall Length 14.5 cm (5 ¾")



78-046-15
Crile-Murray Needle Holder
Slender Pattern
Overall Length 15 cm (6")

Needle Holders
Nadelhalter
Porta-agujas
Porte-aiguilles
Portaghi



Crile-Wood Needle Holder

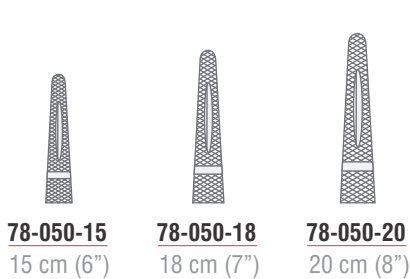

78-050-15
15 cm (6")

78-050-18
18 cm (7")

78-050-20
20 cm (8")



78-052-18
Adson Needle Holder
One Fenestrated Jaw
Overall Length 18 cm (7")

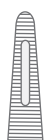

78-054-18
Metzenbaum Needle Holder
One Grooved and Fenestrated Jaws
Overall Length 18.5 cm (7 1/4")

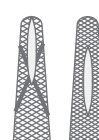

Needle Holders
 Nadelhalter
 Porta-agujas
 Porte-aiguilles
 Portaghi



78-056-17
M.G. Hospital Needle Holder
 Heavy Pattern
 Overall Length 17.5 cm (7")

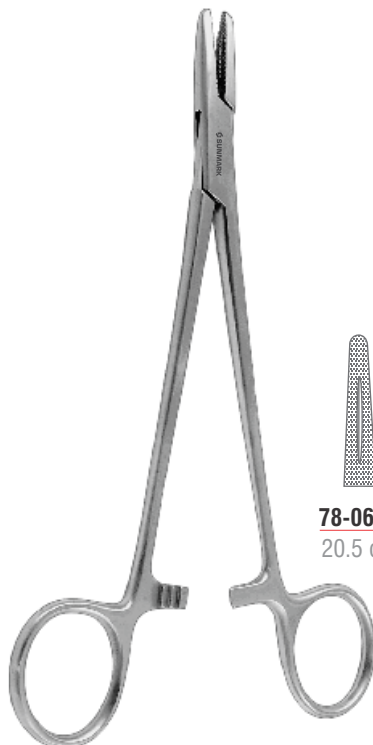

78-060-14
 14.5 cm (5 3/4")



78-060-16
 16 cm (6 1/4")



78-060-18
 18.5 cm (7 1/4")



78-060-20
 20.5 cm (8")



78-060-24
 24 cm (9 1/2")



78-060-26
 26.5 cm (10 1/2")



78-060-30
 30.5 cm (12")

Mayo-Hegar Needle Holder

Needle Holders
Nadelhalter
Porta-agujas
Porte-aiguilles
Portaghi



Mayo-Hegar (Delicate) Needle Holder
Slender Pattern

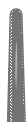

78-062-16
16 cm (6 1/4")



78-062-18
18.5 cm (7 1/4")



78-062-20
20.5 cm (8")



Sarot Needle Holder



78-068-18
18 cm (7")



78-068-26
25.5 cm (10")

Needle Holders
Nadelhalter
Porta-agujas
Porte-aiguilles
Portaghi



78-070-21
Heaney Needle Holder
Overall Length 20.5 cm (8")



78-072-23
Jameson Needle Holder
Overall Length 23.5 cm (9 1/4")

Needle Holders
Nadelhalter
Porta-agujas
Porte-aiguilles
Portaghi



78-074-27
Masson Needle Holder
Overall Length 26.5 cm (10 1/2")



78-077-26
Masson-Luethy Needle Holder
Overall Length 25.5 cm (10")

Needle Holders
Nadelhalter
Porta-agujas
Porte-aiguilles
Portaghi



78-079-27
Finochietto Needle Holder
Overall Length 26.5 cm (10 1/2")



78-082-27
Wangensteen Needle Holder
Overall Length 26.5 cm (10 1/2")



78-085-27
Johnson Needle Holder
Overall Length 27 cm (10 3/4")

Needle Holders
Nadelhalter
Porta-agujas
Porte-aiguilles
Portaghi



Stratte Needle Holder

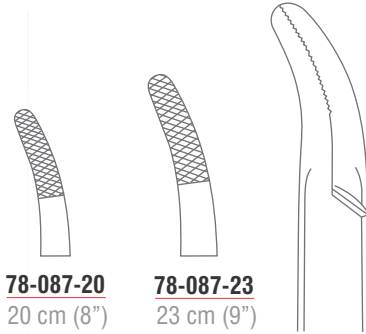

78-087-20
20 cm (8")

78-087-23
23 cm (9")



Olsen-Hegar Needle Holder

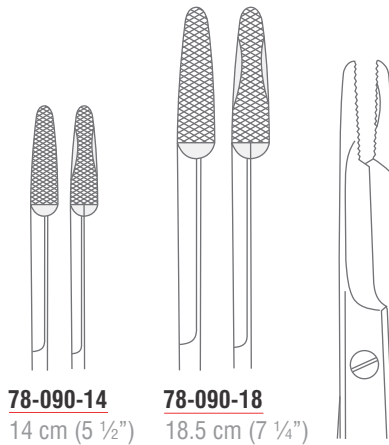

78-090-14
14 cm (5 1/2")

78-090-18
18.5 cm (7 1/4")



78-094-16
Gillies Needle Holder
Overall Length 16 cm (6 1/4")

Needle Holders
Nadelhalter
Porta-agujas
Porte-aiguilles
Portaghi



78-100-14
14 cm (5 1/2")
78-100-17
17 cm (6 3/4")
78-100-20
20 cm (8")

Mathieu Needle Holder



78-102-14
14 cm (5 1/2")
78-102-17
16.5 cm (6 1/2")

Mathieu (Delicate) Needle Holder



78-110-20
14 cm (5 1/2")
78-110-25
16.5 cm (6 1/2")

Lichtenberg Needle Holder



78-120-20
20 cm (8")
78-120-23
23 cm (9")

Zweifel Needle Holder

Needle Holders
 Nadelhalter
 Porta-agujas
 Porte-aiguilles
 Portaghi



78-124-25
Hoesel Needle Holder
 Overall Length 25 cm (9 3/4")



78-130-15
Crile Needle Holder
 Overall Length 15 cm (6")



78-134-18
Toennis Needle Holder
 Overall Length 18.5 cm (7 1/4")



Langenbeck Needle Holder

78-140-16
 16 cm (6 1/4")

78-140-18
 18 cm (7")

78-140-20
 20 cm (8")

Micro Needle Holders
 Mikro-Nadelhalter
 Micro Porta-agujas
 Micro porte-aiguilles
 Micro Portaghi



78-200-10
 Straight

78-201-10
 Curved

78-202-10
 Straight

78-203-10
 Curved

McPherson Micro Needle Holder
 Very Delicate, Without Lock
 Overall Length 10 cm (4")

McPherson Micro Needle Holder
 Very Delicate, With Lock
 Overall Length 10 cm (4")



78-210-14
 Straight

78-211-14
 Curved

78-212-14
 Straight

78-213-14
 Curved

Castroviejo Micro Needle Holder
 Delicate 1.0 x 12 mm Tips, Without Lock
 Overall Length 14 cm (5 1/2")

Castroviejo Micro Needle Holder
 Delicate 1.0 x 12 mm Tips, With Lock
 Overall Length 14 cm (5 1/2")

Micro Needle Holders
Mikro-Nadelhalter
Micro Porta-agujas
Micro porte-aiguilles
Micro Portaghi



Castroviejo Micro Needle Holder
Standard 1.5 x 12 mm Tips, Without Lock
Overall Length 14 cm (5 1/2")



Castroviejo Micro Needle Holder
Standard 1.5 x 12 mm Tips, With Lock
Overall Length 14 cm (5 1/2")

Micro Needle Holders
Mikro-Nadelhalter
Micro Porta-agujas
Micro porte-aiguilles
Micro Portaghi

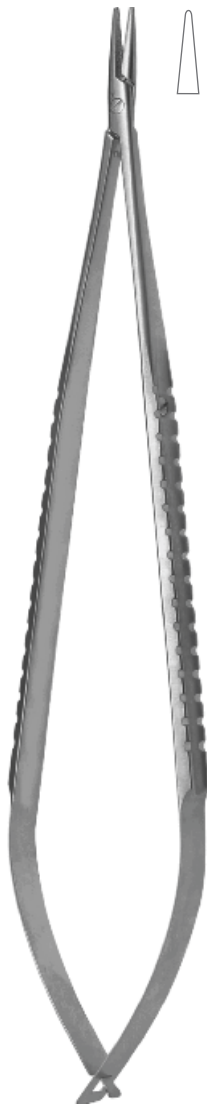

78-230-18
Jacobson Micro Needle Holder
Straight, Without Lock
Overall Length 18.5 cm (7 1/4")



78-231-18
Jacobson Micro Needle Holder
Straight, With Lock
Overall Length 18.5 cm (7 1/4")



78-234-21
Micro Needle Holder
Straight, With Lock
Overall Length 21 cm (8 1/4")

Micro Needle Holders
Mikro-Nadelhalter
Micro Porta-agujas
Micro porte-aiguilles
Micro Portaghi



78-238-16
Straight



78-239-16
Curved

Yasargil Micro Needle Holder
Bayonet Shaped
Overall Length 16 cm (6 1/4")

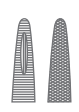

78-246-14
Kalt Micro Needle Holder
Straight, With Lock
Overall Length 13.5 cm (5 1/4")

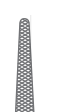
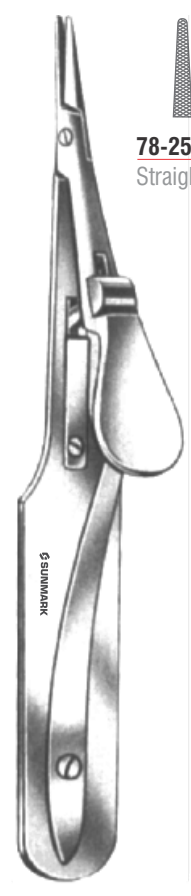

78-250-14
Straight

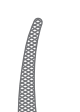

78-251-14
Curved

Arruga Micro Needle Holder
With Lock
Overall Length 13.5 cm (5 1/4")

Micro Needle Holders
Mikro-Nadelhalter
Micro Porta-agujas
Micro porte-aiguilles
Micro Portaghi



78-254-14
Silcock Micro Needle Holder
With Lock
Overall Length 14.5 cm (5 ¾")



78-260-13
Straight

78-261-13
Curved



78-266-16
Curved

78-267-16
Curved

Arruga Needle Holder
With Ratchet
Overall Length 16 cm (6 ¼")

Micro Needle Holders
Mikro-Nadelhalter
Micro Porta-agujas
Micro porte-aiguilles
Micro Portaghi



78-271-16
Micro Needle Holder
Curved, Smooth Jaws, Bayonet Shaped
Overall Length 16 cm (6 1/4")



78-274-23
Straight

Micro Needle Holder
Smooth Jaws, Bayonet Shaped



78-275-23
Curved



78-277-19
Micro Needle Holder
Curved, Smooth Jaws, Bayonet Shaped,
Overall Length 19 cm (7 1/2")

Micro Needle Holders
Mikro-Nadelhalter
Micro Porta-agujas
Micro porte-aiguilles
Micro Portaghi



78-280-20
Straight
20 cm (8")



78-280-23
Straight
23 cm (8")



78-281-20
Curved
20 cm (8")



78-281-23
Curved
23 cm (8")



78-300-10
Straight



78-301-10
Curved

Yasargil Micro Needle Holder
Smooth Jaws, Bayonet Shaped

Barraquer-Troutman Micro Needle Holder
Extra Delicate, Round Handle
Overall Length 10 cm (4")



78-310-10
Straight
10.5 cm (4")



78-310-11
Straight
11.5 cm (4 1/2")



78-311-10
Curved
10.5 cm (4")



78-311-11
Curved
11.5 cm (4 1/2")

Barraquer-Troutman Micro Needle Holder
Very Delicate, Round Handle, With Lock



78-313-11
Barraquer Micro Needle Holder
Curved, Delicate, Round Handle
Overall Length 11.5 cm (4 1/2")

Micro Needle Holders
 Mikro-Nadelhalter
 Micro Porta-agujas
 Micro porte-aiguilles
 Micro Portaghi



78-315-11
Barraquer Micro Needle Holder
 Curved, Delicate, Round Handle, With Lock
 Overall Length 11.5 cm (4 1/2")

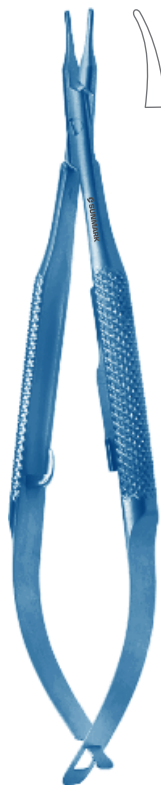

78-315-11 T
Barraquer Micro Needle Holder
 Curved, Delicate, Round Handle, With Lock
 Overall Length 11.5 cm (4 1/2")



78-320-13
 Straight

78-321-13
 Curved

Barraquer Micro Needle Holder
 Very Delicate, Round Handle, Without Lock
 Overall Length 13 cm (5")



78-322-13
 Straight

78-323-13
 Curved

Barraquer Micro Needle Holder
 Very Delicate, Round Handle, With Lock
 Overall Length 13 cm (5")

Micro Needle Holders
Mikro-Nadelhalter
Micro Porta-agujas
Micro porte-aiguilles
Micro Portaghi



78-331-14
Curved

78-332-14
Straight

Barraquer Micro Needle Holder
Very Delicate, Round Handle
Overall Length 14 cm (5 ½")



78-331-14 T
Barraquer Micro Needle Holder
Curved, Very Delicate, Round Handle
Overall Length 14 cm (5 ½")



78-333-14
Barraquer Micro Needle Holder
Curved, Very Delicate, Round Handle, With Lock
Overall Length 14 cm (5 ½")



78-333-14 T
Barraquer Micro Needle Holder
Curved, Very Delicate, Round Handle, With Lock
Overall Length 14 cm (5 ½")





Micro Needle Holders
Mikro-Nadelhalter
Micro Porta-agujas
Micro porte-aiguilles
Micro Portaghi



78-341-12
Without Lock
78-343-12
With Lock



Troutman Micro Needle Holder
Strongly Curved, Delicate, Round Handle
Overall Length 12 cm (4 3/4")



78-350-15
Straight

78-351-15
Curved

Reill Micro Needle Holder
Without Lock
Overall Length 15 cm (6")



78-352-15
Straight

78-353-15
Curved

Reill Micro Needle Holder
With Lock
Overall Length 15 cm (6")

Micro Needle Holders
Mikro-Nadelhalter
Micro Porta-agujas
Micro porte-aiguilles
Micro Portaghi



78-354-18
Straight

78-355-18
Curved



78-356-18
Straight

78-357-18
Curved



78-360-20
Straight
With Lock
20 cm (8")

78-362-23
Straight, Delicate
With Lock
23 cm (9")

Micro Needle Holder
Without Lock
Overall Length 18.5 cm (7 1/4")

Micro Needle Holder
With Lock
Overall Length 18.5 cm (7 1/4")

Micro Needle Holder

Micro Needle Holders
 Mikro-Nadelhalter
 Micro Porta-agujas
 Micro porte-aiguilles
 Micro Portaghi



78-416-17

78-418-17

Diam-n-Dust™ Micro Needle Holder
 Straight, Without Lock
 Overall Length 17 cm (6 3/4")

 **Diam-n-GRIP**



78-420-14

14 cm (5 1/2")

78-420-18

18 cm (7")

78-420-21

21 cm (8 1/4")

78-420-23

23 cm (9")

Diam-n-Dust™ Micro Needle Holder
 Straight, Without Lock

 **Diam-n-GRIP**



78-422-14

14 cm (5 1/2")

78-422-18

18 cm (7")

78-422-21

21 cm (8 1/4")

78-422-23

23 cm (9")

Diam-n-Dust™ Micro Needle Holder
 Straight, With Lock

 **Diam-n-GRIP**



Micro Needle Holders
 Mikro-Nadelhalter
 Micro Porta-agujas
 Micro porte-aiguilles
 Micro Portaghi

Without Lock

Overall Length	Suture Size 7/0 Straight	Suture Size 5/0 Straight	Suture Size 5/0 Curved	Suture Size 4/0 Straight	Suture Size 4/0 Curved
12 cm - 4 3/4"	78-426-12	78-430-12			
14 cm - 5 1/2"		78-430-14	78-431-14		
		78-430-14 T	78-431-14 T		
16 cm - 6 1/4"	78-426-16	78-430-16			
		78-430-16 T			
18 cm - 7"	78-426-18	78-430-18	78-431-18		
	78-426-18 T	78-430-18 T	78-431-18 T		
21 cm - 8 1/4"	78-426-21	78-430-21	78-431-21		
	78-426-21 T	78-430-21 T	78-431-21 T		
23 cm - 9"	78-426-23	78-430-23	78-431-23		
	78-426-23 T	78-430-23 T	78-431-23 T		
25 cm - 9 3/4"	78-426-25	78-430-25			

With Lock

Overall Length	Suture Size 7/0 Straight	Suture Size 5/0 Straight	Suture Size 5/0 Curved	Suture Size 4/0 Straight	Suture Size 4/0 Curved
12 cm - 4 3/4"	78-428-12	78-432-12			
14 cm - 5 1/2"		78-432-14	78-433-14		
		78-432-14 T	78-433-14 T		
16 cm - 6 1/4"	78-428-16	78-432-16			
		78-432-16 T			
18 cm - 7"	78-428-18	78-432-18	78-433-18	78-434-18	78-435-18
	78-428-18 T	78-432-18 T	78-433-18 T		
21 cm - 8 1/4"	78-428-21	78-432-21	78-433-21	78-434-21	78-435-21
	78-428-21 T	78-432-21 T	78-433-21 T		
23 cm - 9"	78-428-23	78-432-23	78-433-23	78-434-23	78-435-23
	78-428-23 T	78-432-23 T	78-433-23 T		
25 cm - 9 3/4"	78-428-25	78-432-25			



Diam-n-Dust™
Micro Needle Holder
 Round Handle



Diam-n-Dust™
Micro Needle Holder
 Round Handle



Micro Needle Holders
Mikro-Nadelhalter
Micro Porta-agujas
Micro porte-aiguilles
Micro Portaghi



78-440-19
19 cm (7 1/2")

78-440-23
23 cm (9")

78-440-25
25 cm (9 3/4")

Diam-n-Dust™ Micro Needle Holder
Straight, Without Lock, Heavy Pattern, Round Handle

 **Diam-n-GRIP**

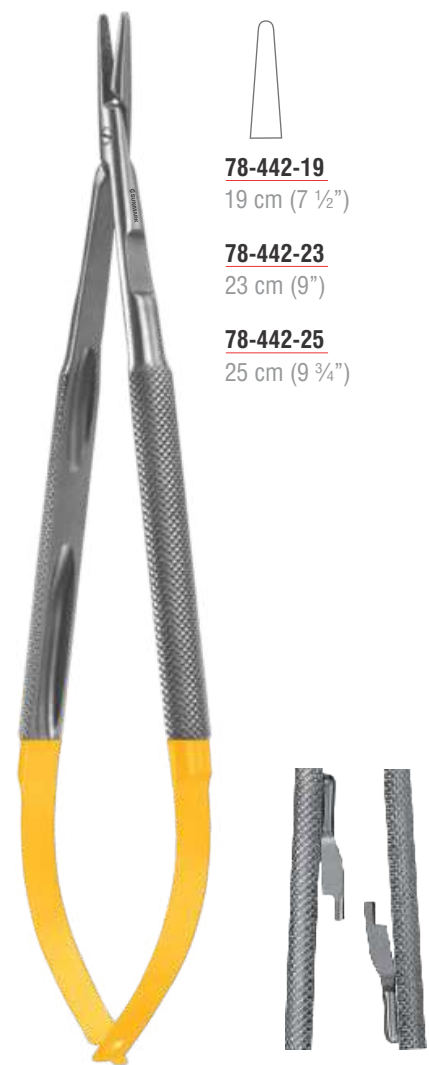

78-442-19
19 cm (7 1/2")

78-442-23
23 cm (9")

78-442-25
25 cm (9 3/4")

Diam-n-Dust™ Micro Needle Holder
Straight, With Lock, Heavy Pattern, Round Handle

 **Diam-n-GRIP**



Micro Needle Holders
Mikro-Nadelhalter
Micro Porta-agujas
Micro porte-aiguilles
Micro Portaghi



78-450-12
Diam-n-Dust™ Castroviejo Micro Needle Holder
Straight, With Lock
Overall Length 12.5 cm (5")

 **Diam-n-GRIP**



78-452-18
Diam-n-Dust™ Hepp-Scheidel Micro Needle Holder
Straight, With Lock
Overall Length 18.5 cm (7 1/4")

 **Diam-n-GRIP**



Needle Holders
Nadelhalter
Porta-agujas
Porte-aiguilles
Portaghi



Diam-n-Dust™ DeBakey Needle Holder



78-460-15
15 cm (6")



78-460-18
18 cm (7")



78-460-20
20 cm (8")



78-460-23
23 cm (9")



Diam-n-Dust™ Ryder Vascular Needle Holder

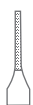

78-470-13
13 cm (5")



78-470-15
15 cm (6")



78-470-18
18 cm (7")

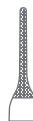

78-470-22
22 cm (8 ¾")

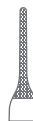

78-470-25
25 cm (9 ¾")



Micro Needle Holders
Mikro-Nadelhalter
Micro Porta-agujas
Micro porte-aiguilles
Micro Portaghi



78-500-13

UltraGrip™ TC Barraquer Micro Needle Holder
Curved, Smooth Jaws, Without Lock, Round Handle
Overall Length 13 cm (5")

ULTRA GRIP X



78-502-13

UltraGrip™ TC Barraquer Micro Needle Holder
Curved, Smooth Jaws, With Lock, Round Handle
Overall Length 13 cm (5")

ULTRA GRIP X

Micro Needle Holders
Mikro-Nadelhalter
Micro Porta-agujas
Micro porte-aiguilles
Micro Portaghi



UltraGrip™ TC Castroviejo Micro Needle Holder
With Lock
Overall Length 14.5 (5 3/4")

ULTRA GRIP X™

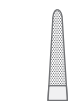

78-510-14
Straight
With Lock



78-512-14
Straight
With Lock
Smooth Jaws

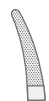

78-511-14
Curved
With Lock



78-513-14
Curved
With Lock
Smooth Jaws



UltraGrip™ TC Micro Needle Holder
With Lock
Overall Length 18 (7")

ULTRA GRIP X™



78-520-18
Straight
With Lock
18 cm (7")



78-521-18
Curved
With Lock
18 cm (7")

Micro Needle Holders
Mikro-Nadelhalter
Micro Porta-agujas
Micro porte-aiguilles
Micro Portaghi



78-530-21
Straight
With Lock



78-531-21
Curved
With Lock



78-536-18



78-536-20

UltraGrip™ TC Jacobson Micro Needle Holder
With Lock
Overall Length 21.5 cm (8 ½")

UltraGrip™ TC Micro Needle Holder
Straight, With Lock
Overall Length 18 cm (7")

ULTRA GRIP 

ULTRA GRIP 



5.0 - 8.0



6.0 & Smaller

Micro Needle Holders
Mikro-Nadelhalter
Micro Porta-agujas
Micro porte-aiguilles
Micro Portaghi



78-540-13
UltraGrip™ TC Castroviejo Micro Needle Holder
Smooth Jaws, With Lock
Overall Length 12.5 cm (5")





78-544-18
UltraGrip™ TC Hepp-Scheidel Micro Needle Holder
Smooth Jaws, With Lock
Overall Length 18.5 cm (7 1/4")



Micro Needle Holders
 Mikro-Nadelhalter
 Micro Porta-agujas
 Micro porte-aiguilles
 Micro Portaghi

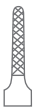
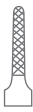

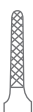

-  **78-550-16**
16 cm (6 ¼")
-  **78-550-18**
18 cm (7")
-  **78-550-20**
20 cm (8")
-  **78-550-23**
23 cm (9")
-  **78-550-26**
26 cm (10 ½")

UltraGrip™ TC Diethrich Micro Needle Holder

ULTRA GRIP[®]



-  **78-560-16**
Straight
-  **78-561-16**
Curved

UltraGrip™ TC Arruga Needle Holder
 Overall Length 16 cm (6 ¼")

ULTRA GRIP[®]



Needle Holders
Nadelhalter
Porta-agujas
Porte-aiguilles
Portaghi



78-564-13
UltraGrip™ TC Webster Needle Holder
With Automatic Release Ratchet
Overall Length 13 cm (5")



78-566-15
UltraGrip™ TC Crile-Wood Needle Holder
With Automatic Release Ratchet
Overall Length 15 cm (6")



78-570-13
UltraGrip™ TC Webster Needle Holder
Smooth Jaws
Overall Length 13 cm (5")



Needle Holders
Nadelhalter
Porta-agujas
Porte-aiguilles
Portaghi



78-573-13
UltraGrip™ TC Kilner Needle Holder
S Shaped
Overall Length 13 cm (5")

ULTRA GRIP X™



78-576-12
UltraGrip™ TC Derf Needle Holder
Overall Length 12 cm (4 ¾")

ULTRA GRIP X™



Needle Holders
Nadelhalter
Porta-agujas
Porte-aiguilles
Portaghi



78-580-13
13 cm (5")



78-580-14
14.5 cm (5")

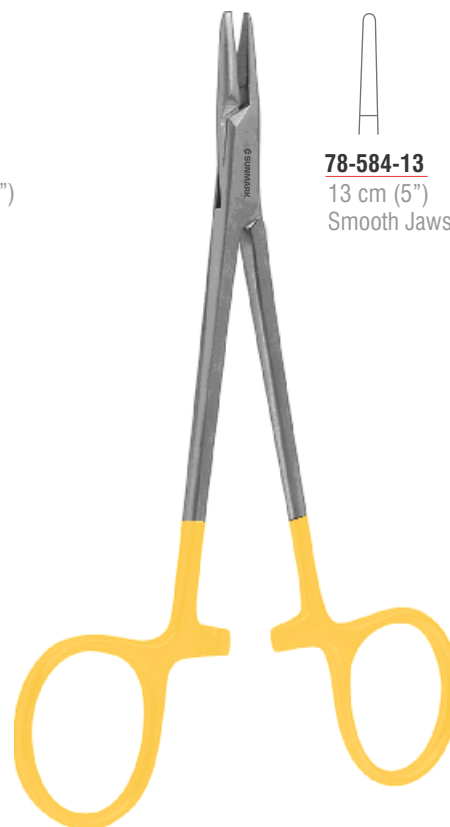

78-584-13
13 cm (5")
Smooth Jaws



78-586-13
13 cm (5")



UltraGrip™ TC Hegar-Baumgartner Needle Holder

UltraGrip™ TC Halsey Needle Holder



Needle Holders
Nadelhalter
Porta-agujas
Porte-aiguilles
Portaghi



78-588-12
UltraGrip™ TC Webster Needle Holder
Smooth Jaw
Overall Length 12 cm (4 ¾")

ULTRA GRIP[™]



78-590-12
UltraGrip™ TC Converse Needle Holder
Overall Length 12.5 cm (5")

ULTRA GRIP[™]



Needle Holders
Nadelhalter
Porta-agujas
Porte-aiguilles
Portaghi



78-594-15
15 cm (6")

78-594-18
18 cm (7")

78-594-20
20 cm (8")

UltraGrip™ TC Crile-Wood Needle Holder

ULTRA GRIP X

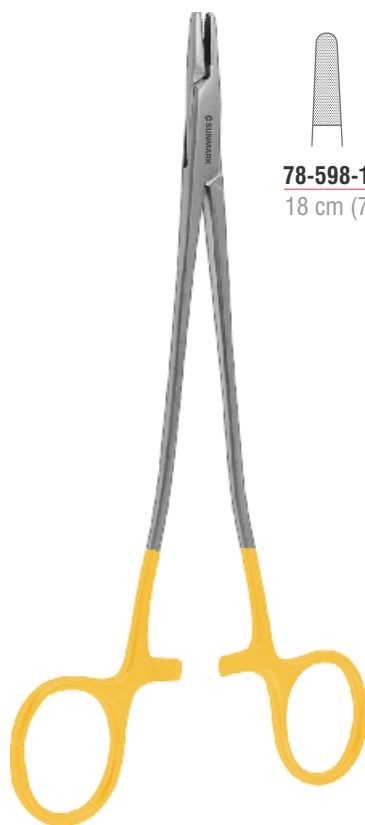

78-598-18
18 cm (7")

78-598-20
20 cm (8")

78-598-26
26 cm (10 1/4")

UltraGrip™ TC Sarot Needle Holder

ULTRA GRIP X



Needle Holders
Nadelhalter
Porta-agujas
Porte-aiguilles
Portaghi



UltraGrip™ TC Mayo-Hegar Needle Holder



78-600-14
14.5 cm (5 ¾")



78-600-16
16 cm (6 ¼")



78-600-18
18 cm (7")



78-600-20
20 cm (8")



78-600-24
24 cm (9 ½")



78-600-26
26 cm (10 ¼")



78-600-30
30 cm (11 ¾")

ULTRA GRIP X



UltraGrip™ TC Hegar Needle Holder



78-602-20
20 cm (8")



78-602-24
23.5 cm (9 ¼")

ULTRA GRIP X



Needle Holders
Nadelhalter
Porta-agujas
Porte-aiguilles
Portaghi



UltraGrip™ TC Heaney Needle Holder

ULTRA GRIP X™

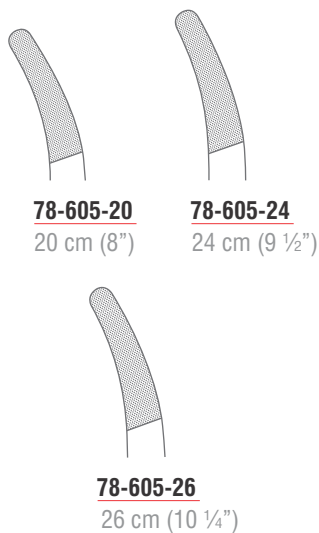

UltraGrip™ TC Bozemann Needle Holder

ULTRA GRIP X™

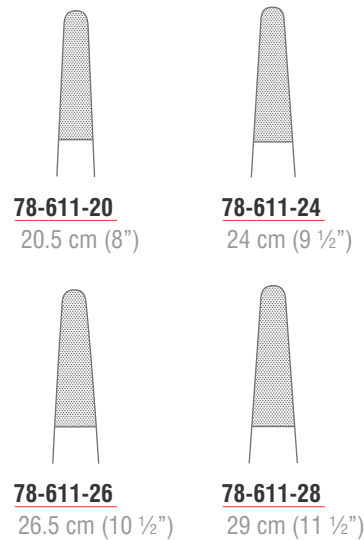

Needle Holders
Nadelhalter
Porta-agujas
Porte-aiguilles
Portaghi



78-615-21
21 cm (8 ¼")

78-615-23
23 cm (9")

UltraGrip™ TC Stratte Needle Holder

78-620-27
UltraGrip™ TC Masson Needle Holder
Overall Length 26.5 cm (10 ½")

ULTRA GRIP X™



ULTRA GRIP X™



Needle Holders
Nadelhalter
Porta-agujas
Porte-aiguilles
Portaghi



78-624-27
UltraGrip™ TC Wangensteen Needle Holder
Overall Length 27 cm (10 3/4")

ULTRA GRIP X



78-625-27
UltraGrip™ TC Needle Holder
Overall Length 27 cm (10 3/4")

ULTRA GRIP X



78-627-27
UltraGrip™ TC Finochietto Needle Holder
Overall Length 26.5 cm (10 1/2")

ULTRA GRIP X



Needle Holders
Nadelhalter
Porta-agujas
Porte-aiguilles
Portaghi



78-630-26

UltraGrip™ TC Naunton-Morgan Needle Holder
Compound Action
Overall Length 26 cm (10 1/4")

ULTRA GRIP X



78-650-18
18 cm (7")



78-650-20
20 cm (8")



78-650-23
23 cm (9")



78-650-26
26 cm (10 1/4")



78-650-31
31 cm (12 1/4")

UltraGrip™ TC DeBakey Needle Holder

ULTRA GRIP X



Needle Holders
 Nadelhalter
 Porta-agujas
 Porte-aiguilles
 Portaghi

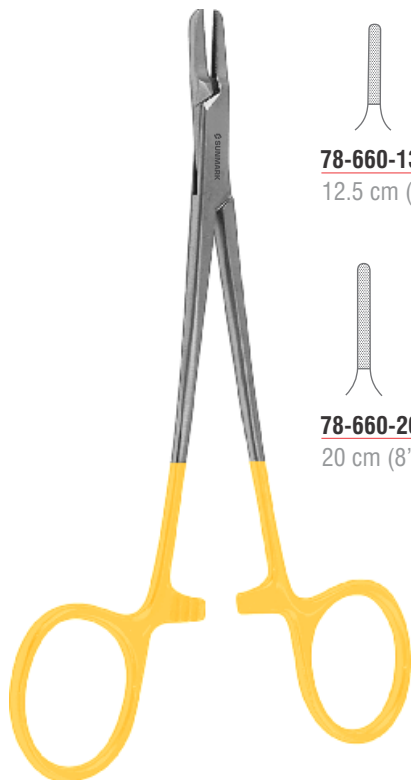

UltraGrip™ TC Ryder Needle Holder

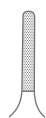

78-660-13
 12.5 cm (5")

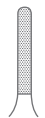

78-660-15
 15 cm (6")

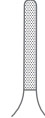

78-660-18
 18 cm (7")

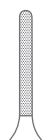

78-660-20
 20 cm (8")

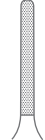

78-660-23
 23 cm (9")

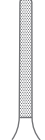

78-660-26
 26 cm (10 1/4")

ULTRA GRIP X



UltraGrip™ TC Ryder-Vascular Needle Holder

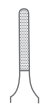

78-664-13
 12.5 cm (5")

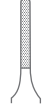

78-664-15
 15 cm (6")

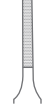

78-664-18
 18 cm (7")

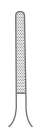

78-664-20
 20 cm (8")

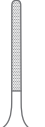

78-664-23
 22.5 cm (8 3/4")

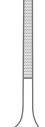

78-664-26
 26 cm (10 1/4")

ULTRA GRIP X



Needle Holders
Nadelhalter
Porta-agujas
Porte-aiguilles
Portaghi







UltraGrip™ TC Martin Needle Holder

ULTRA GRIP X



Needle Holders
Nadelhalter
Porta-agujas
Porte-aiguilles
Portaghi







- | | | | |
|---|---|---|---|
|  |  |  |  |
| 78-674-14
14 cm (5 1/2") | 78-674-18
18.5 cm (7 1/4") | 78-674-20
20.5 cm (8") | 78-674-23
23 cm (9") |

ULTRA GRIP[®]



UltraGrip™ TC Hegar-Vascular Needle Holder



- | | | | |
|---|---|---|---|
|  |  |  |  |
| 78-678-14
14 cm (5 1/2") | 78-678-18
18 cm (7") | 78-678-20
20 cm (8") | 78-678-23
23 cm (9") |

ULTRA GRIP[®]



UltraGrip™ TC Micro Vascular Needle Holder

Needle Holders
 Nadelhalter
 Porta-agujas
 Porte-aiguilles
 Portaghi



78-680-14
 Smooth Jaws
 14 cm (5 ½")



78-680-16
 Smooth Jaws
 16 cm (6 ¼")



78-680-18
 Smooth Jaws
 18 cm (7")



78-680-20
 Smooth Jaws
 20 cm (8")



78-682-14
 14 cm (5 ½")



78-682-16
 16 cm (6 ¼")



78-682-18
 18 cm (7")



78-682-20
 20 cm (8")

UltraGrip™ TC Martini Needle Holder

ULTRA GRIP X



Needle Holders
Nadelhalter
Porta-agujas
Porte-aiguilles
Portaghi



78-690-14
14.5 cm (5 ¾")



78-690-17
17 cm (6 ¾")



78-690-18
19 cm (7 ½")



ULTRA GRIP[®]



UltraGrip™ TC Olsen-Hegar Needle Holder



78-693-11
UltraGrip™ TC Foster-Gillies Needle Holder
Smooth Jaws
Overall Length 11 cm (4 ¼")

ULTRA GRIP[®]

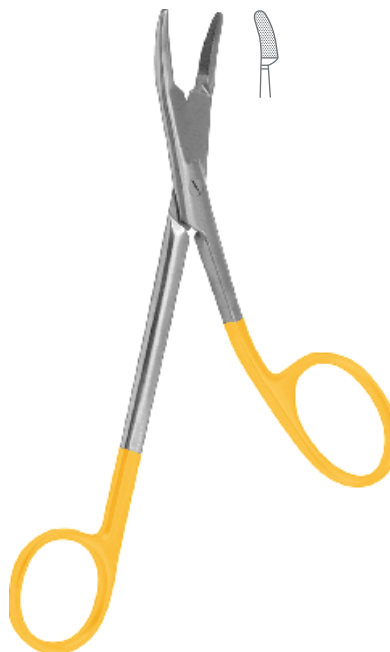

78-695-15
UltraGrip™ TC Gillies-Mini Needle Holder
Overall Length 15 cm (6")

ULTRA GRIP[®]



78-697-16
UltraGrip™ TC Gillies Needle Holder
Overall Length 16 cm (6 ¼")

ULTRA GRIP[®]



Needle Holders
Nadelhalter
Porta-agujas
Porte-aiguilles
Portaghi



78-700-14
14 cm (5 1/2")

78-700-17
17 cm (6 3/4")

78-700-20
20 cm (8")

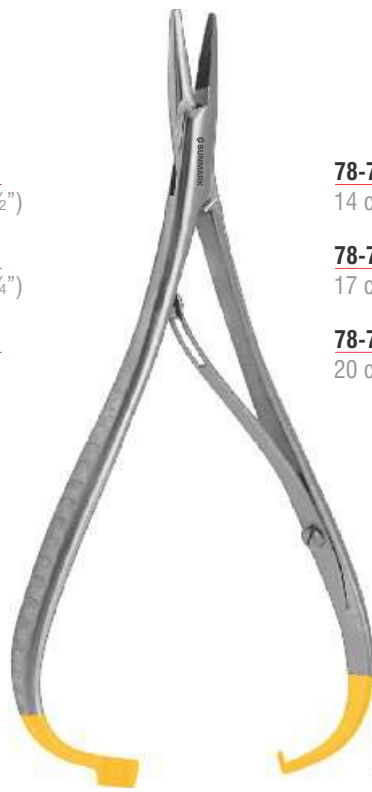

78-702-14
14 cm (5 1/2")

78-702-17
17 cm (6 3/4")

78-702-20
20 cm (8")

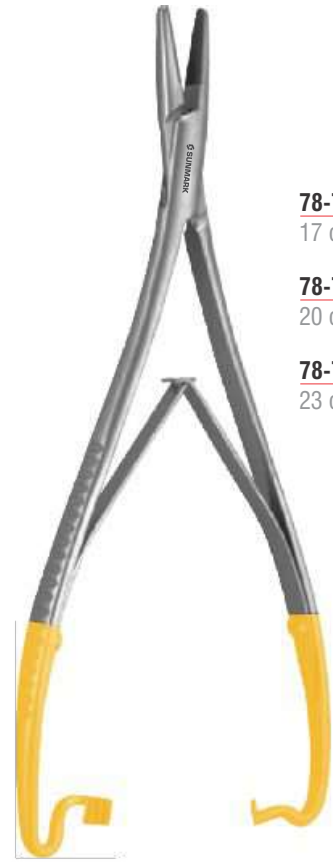

78-706-17
17 cm (6 3/4")

78-706-20
20 cm (8")

78-706-23
23 cm (9")

UltraGrip™ TC Mathieu Needle Holder

UltraGrip™ TC Mathieu Needle Holder

UltraGrip™ TC Mathieu Needle Holder

ULTRA GRIP X

ULTRA GRIP X

ULTRA GRIP X



Needle Holders
Nadelhalter
Porta-agujas
Porte-aiguilles
Portaghi



78-710-20
UltraGrip™ TC Lichtenberg Needle Holder
Overall Length 20 cm (8")



78-720-20
20.5 cm (8")

78-720-23
23 cm (9")

UltraGrip™ TC Zweifel Needle Holder
With Hinged Ratchet



78-730-18
UltraGrip™ TC Toennis Needle Holder
Overall Length 18.5 cm (7 1/4")



78-740-18
18 cm (7")

78-740-18
20.5 cm (8")

78-740-18
23 cm (9")

UltraGrip™ TC Langenbeck Needle Holder

Ligature Clip Applier
 Ligatur Clip Anlegezangen
 Aplicador de clips para ligadura
 Appicateur de pince à ligature
 Applicatore di clip per legature



Ligature Clip Applier



78-751-25
 Angled 25°
 15 cm (6")



78-753-25
 Angled 25°
 20 cm (8")



78-753-65
 Angled 65°
 20 cm (8")



78-755-25
 Angled 25°
 28 cm (11")



78-755-65
 Angled 65°
 28 cm (11")

For Small Clips



78-761-25
 Angled 25°
 15 cm (6")



78-763-25
 Angled 25°
 20 cm (8")



78-763-65
 Angled 65°
 20 cm (8")



78-765-25
 Angled 25°
 28 cm (11")



78-765-65
 Angled 65°
 28 cm (11")

For Medium Clips

Ligature Clip Applier
Ligatur Clip Anlegezangen
Aplicador de clips para ligadura
Applicateur de pince à ligature
Applicatore di clip per legature



Ligature Clip Applier



78-773-25
Angled 25°
20 cm (8")



78-773-65
Angled 65°
20 cm (8")



78-773-90
Angled 90°
20 cm (8")



78-775-25
Angled 25°
28 cm (11")



78-775-65
Angled 65°
28 cm (11")



78-775-90
Angled 90°
28 cm (11")

For Medium/Large Clips

Ligature Clip Applier
 Ligatur Clip Anlegezangen
 Aplicador de clips para ligadura
 Applicateur de pince à ligature
 Applicatore di clip per legature



Ligature Clip Applier



78-783-25
 Angled 25°
 20 cm (8")



78-783-65
 Angled 65°
 20 cm (8")



78-783-90
 Angled 90°
 20 cm (8")



78-785-25
 Angled 25°
 28 cm (11")



78-785-65
 Angled 65°
 28 cm (11")



78-785-90
 Angled 90°
 28 cm (11")

For Large Clips



Ligature Needles
 Unterbindungsnadeln
 Aguja para ligaduras
 Aiguilles à ligatures
 Aghi per legatura



78-801-15



78-803-15



78-805-15

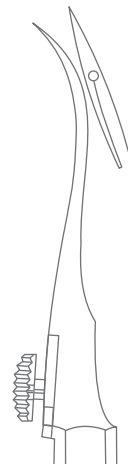

78-807-15

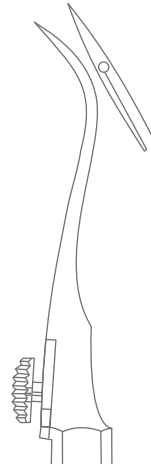

Reverdin Ligature Needle
 Short
 Overall Length 14.5 cm (5 3/4")

Ligature Needles
Unterbindungsnadeln
Agujas para ligaduras
Aiguilles à ligatures
Aghi per legatura

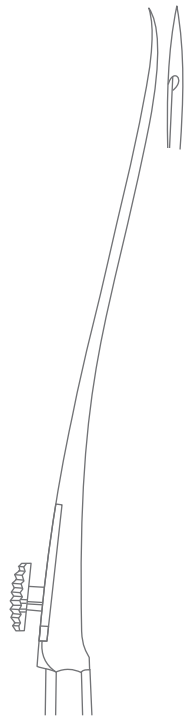

78-811-19

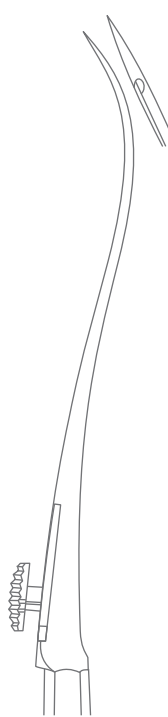

78-813-19

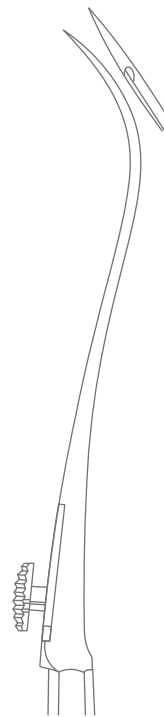

78-815-19

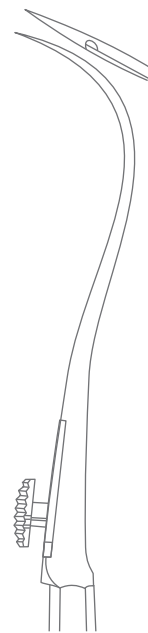

78-817-19

Reverdin Ligature Needle
Medium
Overall Length 19.5 cm (7 3/4")

Ligature Needles
Unterbindungsnadeln
Agujas para ligaduras
Aiguilles à ligatures
Aghi per legatura

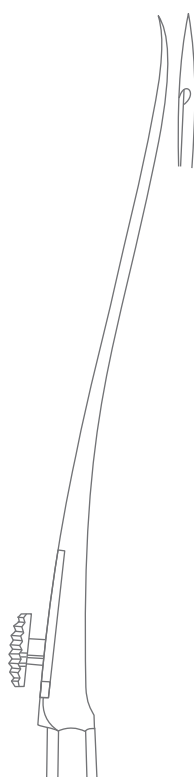

78-821-23

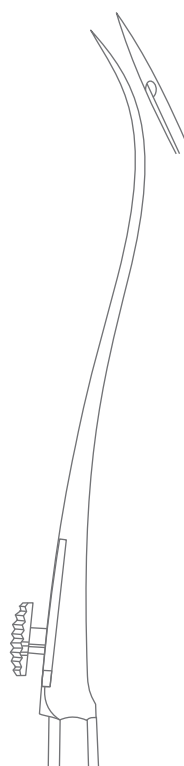

78-823-23

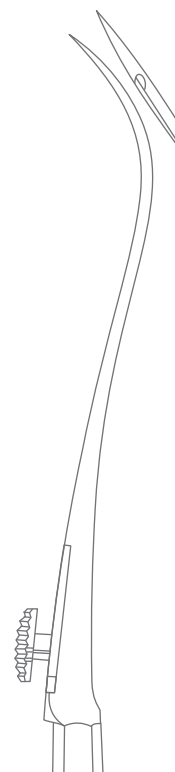

78-825-23

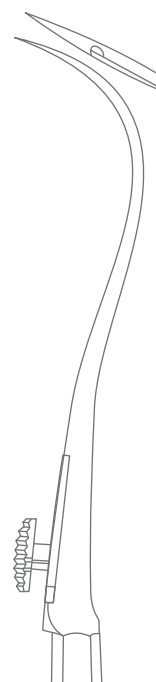

78-827-23

Reverdin Ligature Needle
Large
Overall Length 23 cm (9")

Ligature Needles
Unterbindungsnadeln
Agujas para ligaduras
Aiguilles à ligatures
Aghi per legatura



78-831-00
Young Ligature Needle Holder Complete
With Needle Ref: 78-831-01
Overall Length 24.5 cm (9 3/4")



78-835-32
Schmieden-Dick Ligature Needle
Malleable
Overall Length 29 cm (11 1/2")



78-837-21
Schmieden Ligature Needle
Overall Length 24 cm (9 1/2")

Ligature Needles
 Unterbindungsnadeln
 Agujas para ligaduras
 Aiguilles à ligatures
 Aghi per legatura



78-841-20
Ligature Needle
 Malleable
 Overall Length 20.5 cm (8")



78-843-18
Jonesco Ligature Needle
 Overall Length 18.5 cm (7 1/4")



78-845-25
Claus Van Eicken Ligature Needle
 Overall Length 25 cm (9 3/4")



78-849-15
Ligature Needle
 Overall Length 15 cm (6")

Ligature Needles
 Unterbindungsnadeln
 Agujas para ligaduras
 Aiguilles à ligatures
 Aghi per legatura

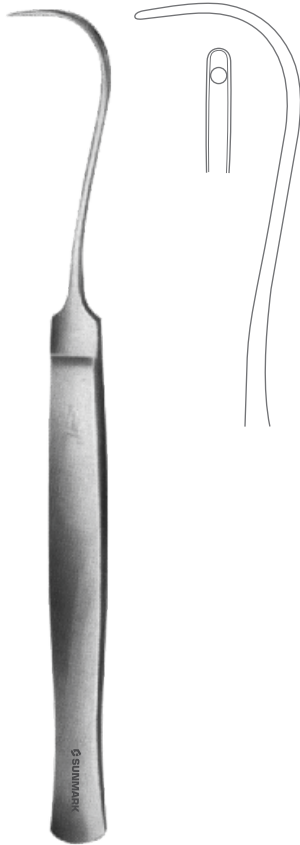

78-851-17
Syme Ligature Needle
 Overall Length 17 cm (6 ¾")



78-853-19
Cooper Ligature Needle
 Overall Length 18.5 cm (7 ¼")

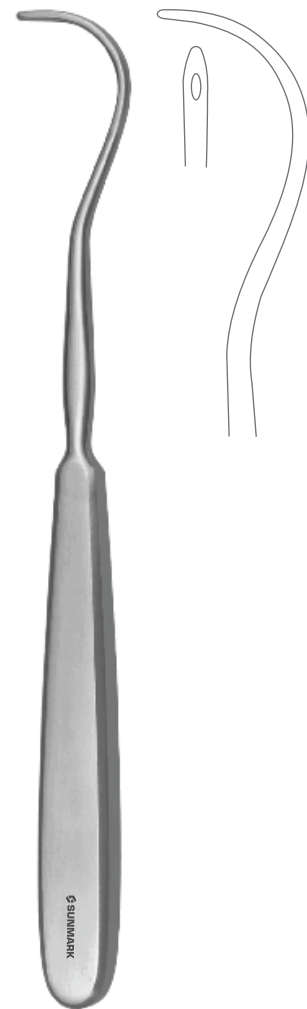

78-855-20
Kocher Ligature Needle
 Overall Length 20.5 cm (8")

Ligature Needles
 Unterbindungsnadeln
 Aguja para ligaduras
 Aiguilles à ligatures
 Aghi per legatura



78-861-13
Right Hand



78-863-13
Left Hand

Kronecker Ligature Needle
Delicate
Overall Length 12.5 cm (5")

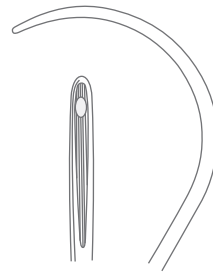

78-871-24
Right Hand

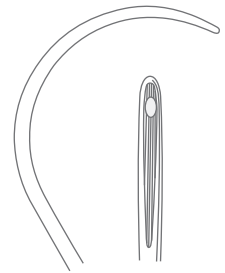

78-873-24
Left Hand

Deschamps Ligature Needle
Blunt
Overall Length 24 cm (9 1/2")

Ligature Needles
 Unterbindungsnadeln
 Agujas para ligaduras
 Aiguilles à ligatures
 Aghi per legatura



78-875-20
Right Hand

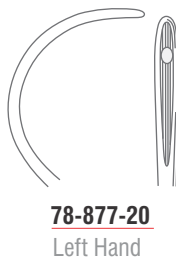

78-877-20
Left Hand



78-879-20
Left Hand

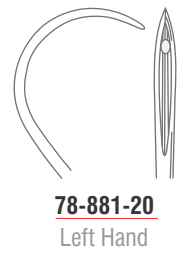

78-881-20
Left Hand

Deschamps Ligature Needle
Blunt
Overall Length 20 cm (8")

Deschamps Ligature Needle
Sharp
Overall Length 20 cm (8")

Ligature Needles
Unterbindungsnadeln
Agujas para ligaduras
Aiguilles à ligatures
Aghi per legatura

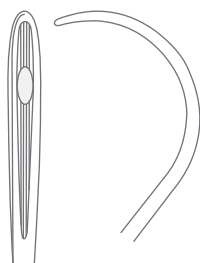

78-883-21
Right Hand

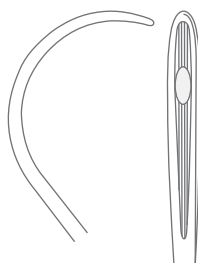

78-885-21
Left Hand

Deschamps Ligature Needle
Blunt
Overall Length 20 cm (8")



78-887-20
Right Hand



78-889-20
Left Hand

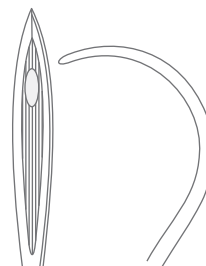

78-891-21
Right Hand

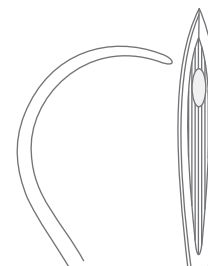

78-893-21
Left Hand

Deschamps Ligature Needle
Sharp
Overall Length 20 cm (8")

Deschamps Ligature Needle
Sharp
Overall Length 20 cm (8")

Ligature Needles
 Unterbindungsnadeln
 Agujas para ligaduras
 Aiguilles à ligatures
 Aghi per legatura

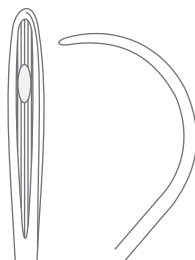

78-895-27
Blunt, Right Hand

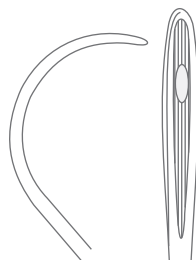

78-897-27
Blunt, Left Hand

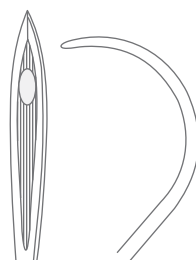

78-901-27
Sharp, Right Hand

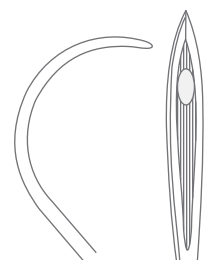

78-903-27
Sharp, Left Hand

Deschamps Ligature Needle
 Overall Length 27 cm (10 3/4")

Ligature Needles
 Unterbindungsnadeln
 Aguja para ligaduras
 Aiguilles à ligatures
 Aghi per legatura

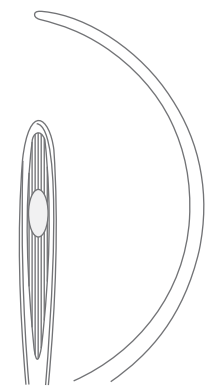

78-905-28
Right Hand

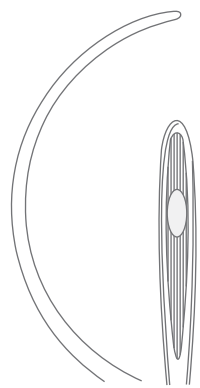

78-907-28
Left Hand

Deschamps Ligature Needle
 Blunt
 Overall Length 28 cm (11")

Ligature Needles
 Unterbindungsnadeln
 Agujas para ligaduras
 Aiguilles à ligatures
 Aghi per legatura



Deschamps Ligature Needle
 Sharp
 Overall Length 20 cm (8")



78-911-20
 Right Hand



78-913-20
 Left Hand



Deschamps Ligature Needle
 Blunt
 Overall Length 20 cm (8")



78-915-20
 Right Hand

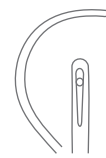

78-917-20
 Left Hand

Ligature Needles
 Unterbindungsnadeln
 Aguja para ligaduras
 Aiguilles à ligatures
 Aghi per legatura

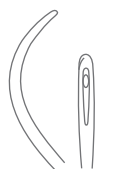

78-921-20
Right Hand



78-923-20
Left Hand

Deschamps Ligature Needle
Blunt
Overall Length 21 cm (8 1/4")



78-927-21
Right Hand

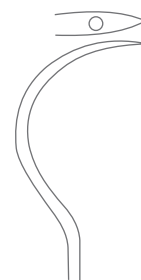

78-929-21
Left Hand

Hurd Ligature Needle
Sharp
Overall Length 20.5 cm (8")

Ligature Needles
 Unterbindungsnadeln
 Agujas para ligaduras
 Aiguilles à ligatures
 Aghi per legatura



78-931-01
Fig. 1



78-931-02
Fig. 2



78-931-03
Fig. 3



78-931-04
Fig. 4

Brunner Ligature Needle
 Overall Length 30 cm (11 3/4")

Ligature Needles
 Unterbindungsnadeln
 Agujas para ligaduras
 Aiguilles à ligatures
 Aghi per legatura



78-935-25
Kirschner Ligature Needle
 Overall Length 25.5 cm (10")

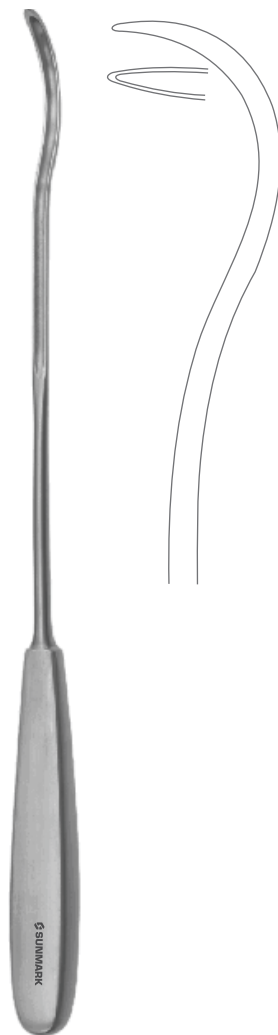

78-937-28
Ligature Needle
 Overall Length 28 cm (11")

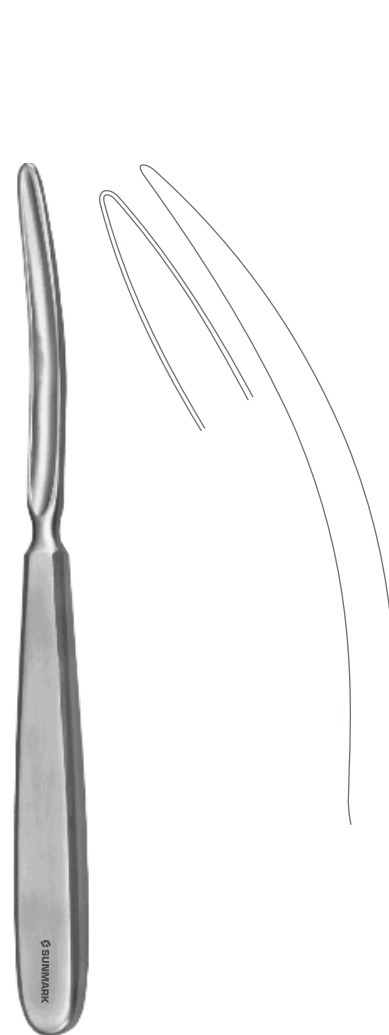

78-939-25
Martin Ligature Needle
 Overall Length 19.5 cm (7 3/4")

Ligature Needles
Unterbindungsnadeln
Agujas para ligaduras
Aiguilles à ligatures
Aghi per legatura



78-941-18
Brunner Ligature Conductor
Ferrozell
Overall Length 18 cm (7")



78-943-27
Kirschner Ligature Conductor
Ferrozell
Overall Length 27 cm (10 3/4")



78-945-19
Ligature Conductor
Ferrozell
Overall Length 19 cm (7 1/2")



78-949-24
Ligature Conductor
Ferrozell
Overall Length 24 cm (9 1/2")

Ligature Needles
 Unterbindungsnadeln
 Agujas para ligaduras
 Aiguilles à ligatures
 Aghi per legatura



Schmieden Ligature Needle
 Overall Length 18 cm (8")

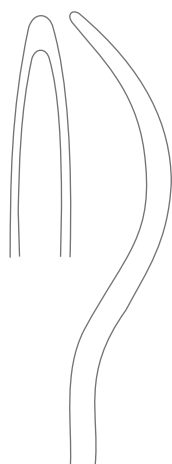

78-951-19
 Without Eye

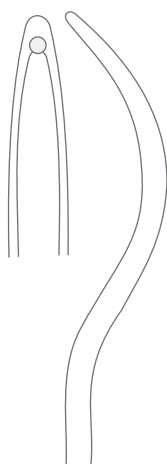

78-953-19
 With Eye



Schmieden Ligature Needle
 Overall Length 19.5 cm (7 3/4")



78-955-03



78-955-05



78-955-07

Ligature Needles
 Unterbindungsnadeln
 Agujas para ligaduras
 Aiguilles à ligatures
 Aghi per legatura



Payr Ligature Needle
 Overall Length 22 cm (8 3/4")

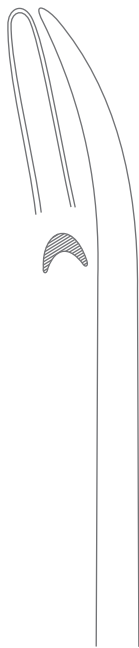

78-957-22



78-959-22



78-961-23
Modell Wien Ligature Catcher
 Overall Length 23.5 cm (9 1/4")



78-963-21
Bozemann Knot Tier
 Overall Length 21 cm (8 1/4")

Ligature Conductors
Führungshohlsonden
Sondas conductoras
Sondes conductrices
Sonde conduttrici



78-965-23
Ligature Adjuster
Overall Length 23 cm (9")



78-967-23
Caspar Ligature Adjuster
Bayonet Shaped
Overall Length 23 cm (9")



78-969-24
Millin Ligature Holding Forcep
Overall Length 24 cm (9 1/2")

Clip Applying Forceps
Wundklammerpinzetten, Wundklammerzängchen
Pinzas aplicadoras para agrafes
Pinces à poser les agrafes
Pinze per applicare le agrafe



78-980-18
Childe Approximation Forcep
Heavy Pattern With Clip Holder
Overall Length 17.5 cm (7")



78-984-12
Michel Clip Applying Forcep
Overall Length 12 cm (4 3/4")



78-986-12
Hegenbarth Clip Applying Forcep
Overall Length 12 cm (4 3/4")

Clip Applying Forceps
Wundklammerpinzetten, Wundklammerzängchen
Pinzas aplicadoras para agrafes
Pincers à poser les agrafes
Pinze per applicare le agrafe



78-988-12
Wachenfeldt Clip Applying Forcep
Overall Length 12 cm (4 ¾")



78-990-12
Michel Clip Applying & Removing Forcep
For Applying and Removal of Clips
Overall Length 12.5 cm (5")



78-992-12
Michel Clip Applying & Removing Forcep
Long Jaws For Applying and Removal of Clips
Overall Length 13 cm (5")

Clip Applying Forceps
Wundklammerpinzetten, Wundklammerzängchen
Pinzas aplicadoras para agrafes
Pincas à poser les agrafes
Pinze per applicare le agrafe



78-994-13
Collin Clip Applying Forcep
With Screw Lock
Overall Length 13 cm (5")



78-995-14
Clip Applying Forcep
Overall Length 14 cm (5 1/2")

Clip Applying Forceps
Wundklammerpinzetten, Wundklammerzängchen
Pinzas aplicadoras para agrafes
Pincers à poser les agrafes
Pinze per applicare le agrafe



78-997-14
Richter Clip Applying Forcep
With Screw Lock
Overall Length 13.5 cm (5 1/4")



Surgical Needle
Pack of 12



78-999-01
7.5 x 1.75 mm



78-999-02
11 x 2.0 mm



78-999-03
12 x 3.0 mm



78-999-04
14 x 3.0 mm



78-999-05
16 x 3.0 mm



78-999-06
18 x 3.0 mm



78-999-07
20 x 3.0 mm



78-999-08
22 x 3.0 mm



78-999-09
22 x 3.0 mm

78-998-04
Fig. 4

78-998-08
Fig. 8

78-998-20
Fig. 00, 1/2 Circle

Michel Suture Clips
Pack of 1000

Plaster Shears, Plaster Knives
 Gipsscheren, Gipsmesser
 Tijeras para yeso, Cuchillos para yeso
 Ciseaux pour plâtre, Couteaux pour plâtre
 Forbici per gesso, Coltelli per gesso

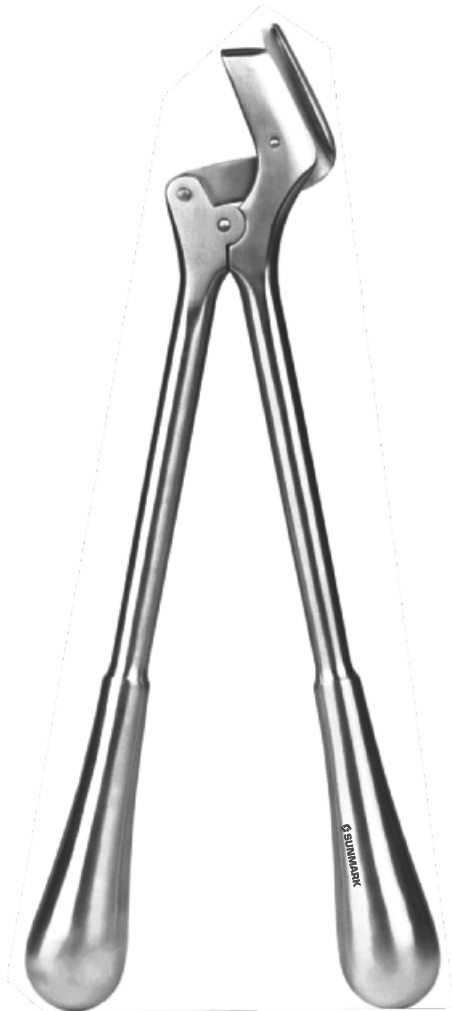

Stille Plaster of Paris Shear

37-100-23
23 cm (9")

37-100-26
27 cm (10 3/4")

37-100-37
38 cm (15")



37-150-20
Hopkins Plaster Knife
Overall Length 20 cm (8")



37-156-18
Esmarch Plaster Knife
Overall Length 18 cm (8")

Plaster Knives, Plaster Spreaders
 Gipsmesser, Gipsspreizer
 Cuchillos para yeso, Separadores para yeso
 Couteaux pour plâtre, Pinces pour plâtre
 Coltelli per gesso, Pinze per gesso



37-160-18
Reiner Plaster Knife
 Overall Length 18 cm (7")



37-164-21
Martin Plaster Knife
 Overall Length 21 cm (8 1/4")



37-171-15
Engel Plaster Knife
 Overall Length 15.5 cm (6")



37-200-48
Beeson Plaster Knife
 Overall Length 30 cm (12")

Plaster Spreaders
Gipsspreizer
Separadores para yeso
Pinces pour plâtre
Pinze per gesso



37-220-28
Hennig Plaster Spreader
Overall Length 28 cm (11")



37-228-23
Quattro (Mod. USA) Plaster Spreader
Overall Length 23 cm (9")



37-251-18
18 cm (7")

37-251-26
26.5 cm (10 ½")

Wolf Plaster Breaker

Plaster Shears
Gipsscheren
Tijeras para yeso
Ciseaux pour plâtre
Forbici per gesso



Surtex Oscipower™ Plaster Saw

37-300-00
220 V

37-300-01
110 V



37-320-01
Wrench
Pair

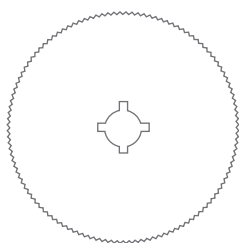

Round Saw Blade

37-310-44
Ø 44 mm

37-310-50
Ø 50 mm

37-310-65
Ø 65 mm

37-310-80
Ø 80 mm

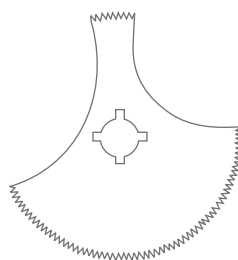

37-314-65
Segment Saw Blade
Ø 65 mm

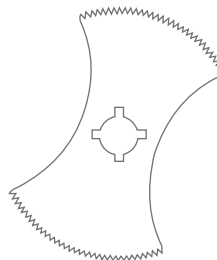

37-318-65
Waisted Saw Blade
Ø 65 mm

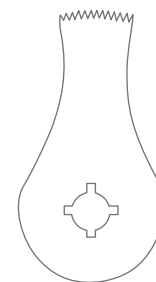

37-320-70
Deep Saw Blade
Ø 70 mm

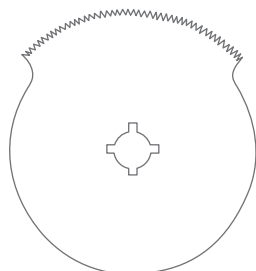

37-322-80
Deep Saw Blade For Aspiration
Ø 80 mm



Vacuum Cleaner
Knopfsonden, Hohlsonden
Sondas abotonadas, Sondas acanaladas
Sondes boutonnées, Sondes cannelées
Sonde a bottone, Sonde cannellate



37-400-00
Vacuum Cleaner

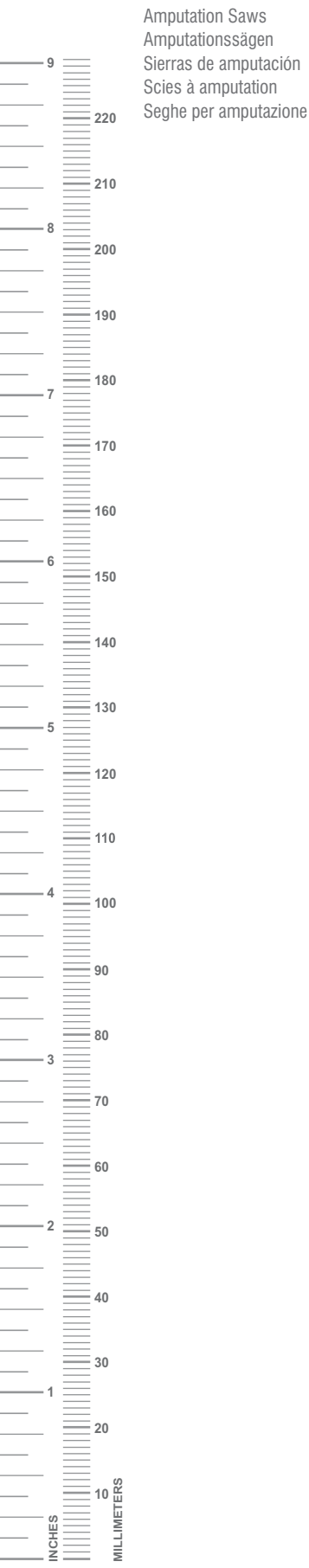

Amputation Saws
Amputationssägen
Sierras de amputación
Scies à amputation
Seghe per amputazione



78-010-35
Charriere Amputation Saw Complete
With Saw Blade Ref: 67-010-92
Overall Length 35 cm (13 3/4")



- 67-010-91**
12 mm
- 67-010-92**
15 mm
- 67-010-93**
18 mm

Charriere Saw Blade



78-012-40
Bier Amputation Saw Complete
With Saw Blade Ref: 67-012-92
Overall Length 40.5 cm (16")



- 67-012-91**
4 mm
- 67-012-92**
6 mm
- 67-012-93**
8 mm

Bier Saw Blade

Amputation Saws
Amputationssägen
Sierras de amputación
Scies à amputation
Seghe per amputazione

67

BONE SURGERY



67-014-24
Langenbeck Amputation Saw
Overall Length 24.5 cm (9 ¾")



67-016-27
Charriere Amputation Saw Complete
With Saw Blade Ref: 67-016-90
Overall Length 26.5 cm (10 ½")

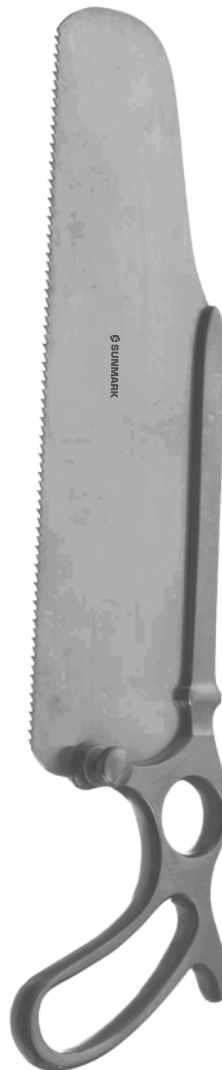

67-018-29
Satterlee Amputation Saw Complete
With Saw Blade Ref: 67-018-90
Overall Length 29 cm (11 ½")



67-018-90
Satterlee Saw Blade

Reamer
Reibahlen
Escariadores
Pointes-carrées
Punteruoli



67-020-00
Handheld Bone Mill



67-022-00
Champy Bone Biopsy (Instruments Set Consisting of Trocar)
Toothed Trepine And A Plunger Reamer
Overall Length 22 cm (8 1/2")

Reamer, Hand Drills
Reibahlen
Escariadores, Perforadores de mano
Pointes-carrées, Perforateurs à main
Punteruoli, Perforatori a mano



67-024-13
Bone Reamer
Overall Length 13.5 cm (5 1/4")



67-026-18
Perthes Bone Reamer
Overall Length 18 cm (7")



67-028-21
Perthes Bone Reamer
Overall Length 21.5 cm (8 1/2")



67-030-14
Bone Reamer
Overall Length 14 cm (5 1/2")



67-034-00
Drill Handle with Chuck
T-Form, With Key Ref: 67-034-90



67-034-90
Key

Hand Drills
 Handbohrapparate
 Perforadores de mano
 Perforateurs à main
 Perforatori a mano



67-036-00
Drill Handle With Chuck
 Longitudinally Bored
 With Key Ref: 67-036-90



67-036-90
Key



67-040-00
Stille-Sherman Drill Handle Complete
 With Twist Drill Ref: 67-044-01 to 67-044-03
 Overall Length 25 cm (9 3/4")



67-042-00
Stille Drill Handle Complete
 With Twist Drill Ref: 67-044-01 to 67-044-03
 Overall Length 20.5 cm (8")

Hand Drills
Handbohrapparate
Perforadores de mano
Perforateurs à main
Perforatori a mano



Twist Drill

67-044-01
Ø 2.5 mm
Fig. 1

67-044-02
Ø 3.0 mm
Fig. 2

67-044-03
Ø 3.5 mm
Fig. 3

67-044-04
Ø 4.0 mm
Fig. 4



67-044-05
Trephine
Fig. 5, Ø 10.0 mm



67-050-00
Hudson Hand Drill Complete
Complete With 4 Burrs Ref:- 67-050-01 up to 67-050-04
& Extension Piece 67-050-09



Conical Burr

67-050-01
Fig. 1
Ø 9.0 mm

67-050-02
Fig. 1
Ø 14.0 mm



Spherical Burr

67-050-03
Fig. 3
Ø 16.0 mm

67-050-04
Fig. 4
Ø 22.0 mm



67-050-05
Cushing Flat Trephine
Fig. 5, Ø 14.0 mm



67-050-07
McKenzie Burr
Fig. 7, Ø 13.0 mm



67-050-09
Extension Piece

Hand Drills
Handbohrapparate
Perforadores de mano
Perforateurs à main
Perforatori a mano

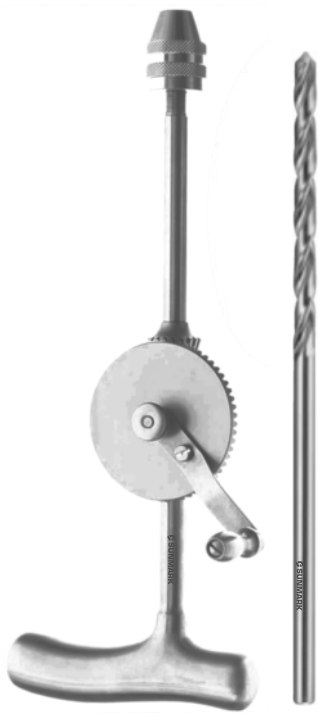

67-054-00
Moore Handle Drill (Complete)
With A Set of Twist Drill Ref: 67-053-03



67-053-03
Twist Drill
Set of 3
(2 Pcs (Ø 3.2 x 70 mm and
1 Pcs Ø 3.2 mm x 90 mm)



67-058-00
Martin Handle Drill (Complete)
With Jacobs With Ref: 67-588-91 and 67-058-92

Twist Drill, Hand Drills
 Spiralbohrer, Handbohrapparate
 Broca espiral, Perforadores de mano
 Mèche hélicoïdale, Perforateurs à main
 Punte a spirale, Perforatori a mano



67-070-10 Ø 1.0 mm	67-070-32 Ø 3.2 mm
67-070-15 Ø 1.5 mm	67-070-35 Ø 3.5 mm
67-070-20 Ø 2.0 mm	67-070-40 Ø 4.0 mm
67-070-25 Ø 2.5 mm	67-070-45 Ø 4.5 mm
67-070-28 Ø 2.8 mm	67-070-50 Ø 5.0 mm
67-070-30 Ø 3.0 mm	67-070-60 Ø 6.0 mm

Twist Drill
Smooth Shaft



67-094-00
Bunnell Hand Drill
Longitudinally Bored With 3 Jaws Chuck and Key,
Light Metal Housing Opening up to Ø 4.0 mm

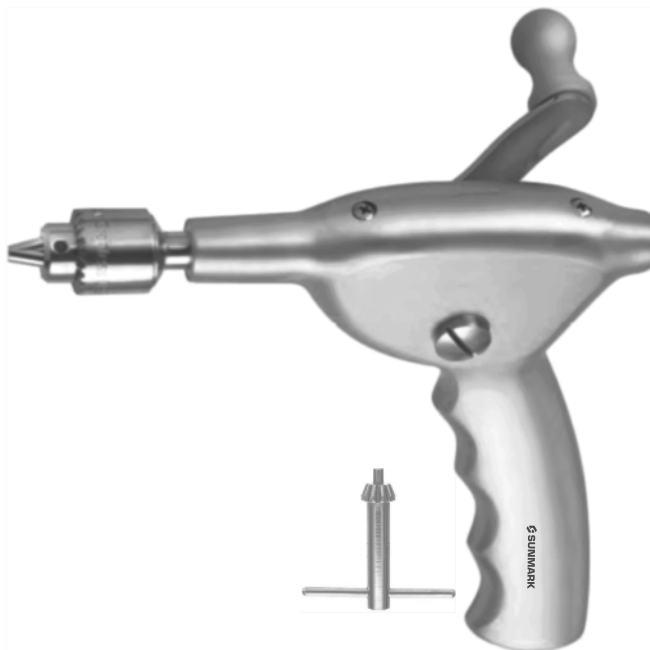

67-096-00
Ralk Hand Drill
Longitudinally Bored With 3 Jaws Chuck and Key,
Light Metal Housing Opening up to Ø 4.0 mm

Screw Driver, Wire Guides
 Handbohrapparate, Drahtumführungsadeln
 Perforadores de mano, Agujas pasa-hilo
 Perforateurs à main, Aiguilles passe-fils
 Perforatori a mano, Aghi passafili



FiberGrip™ Screw Driver
 Overall Length 25 cm (10")

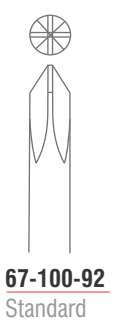
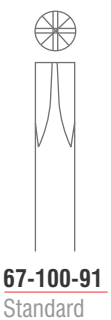
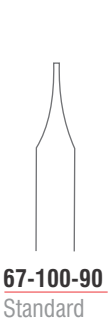
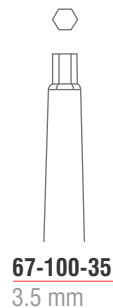
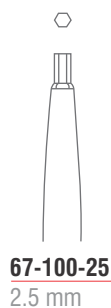
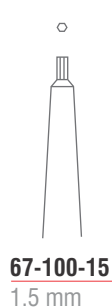

Demel Wire Guide

67-101-01
Fig. 1
31 cm (12 1/4")

67-101-02
Fig. 2
29 cm (11 1/2")

67-101-03
Fig. 3
28 cm (11")



67-103-18
FiberGrip™ Suture Passer
Overall Length 18.5 cm (7")



Wire Tightener, Extension Bows
 Drahtspanner, Extensionsbügel
 Tensor cierra-hilo, Estribos para extensión
 Tendeur serre-fil, Etriers à extension
 Strumento tendifili, Archi per estensione



67-104-21
Loute Wire Tightener
 Overall Length 21 cm (8 1/4")



67-106-27
Demel Wire Tightener and Twister
 Overall Length 27 cm (10 3/4")



Bohler Extension Bows

67-110-15
 210 x 150 mm
 For Femur and Knee

67-110-16
 160 x 90 mm
 For Arm

67-110-21
 210 x 110 mm
 For Femur and Knee

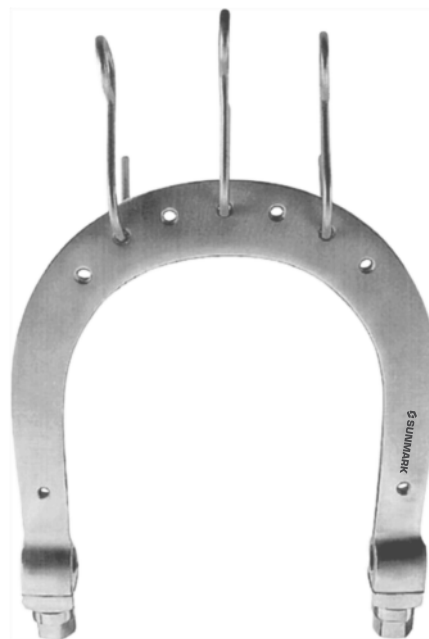

Kirschner Extension Bows
 With 3 Traction Hooks

67-114-01
 90 x 70 mm
 For Children

67-114-02
 105 x 105 mm
 For Wrist and Ankle

67-114-03
 120 x 120 mm
 For Elbow

67-114-04
 155 x 155 mm
 For Knee

67-114-05
 200 x 155 mm
 For Femur

Extension Bows
 Extensionsbügel
 Estribos para extensión
 Etriers à extension
 Archi per estensione



67-116-01
 Small Pattern
 18.5 cm (7 1/4")

67-116-02
 Large Pattern
 26.5 cm (10 1/2")

Kirschner Extension Bows
 With 3 Traction Hooks



67-122-18
 180 x 100 mm (7" x 4")

67-122-27
 270 x 160 mm (10 1/2" x 6 1/4")

Extension Bows



67-118-18
Wire Strainer
 For Ref: 67-581-01 up to 67-581-05
 Overall Length 18.5 cm (7 1/4")



67-120-20
Wrench
 Overall Length 20 cm (8")

Wire Twisting Forceps
Drahtwirbelzangen
Pinzas para torcer alambre
Pinces à torsader le fil
Pinze per ritorcere fili

67

BONE SURGERY



Bone Holding Clamp
 Drahtwirbelzangen
 Pinzas para torcer alambre
 Pincas à torsader le fil
 Pinze per ritorcere fili



67-160-12
 12 cm (4 3/4")

67-160-18
 18 cm (7")

67-160-20
 20 cm (8")

67-160-22
 22 cm (8 3/4")

Gerster-Lowman Bone Holding Clamp



67-162-15
Gerster Traction Bar



67-164-18
 18.5 cm (7 1/4")

67-164-20
 20 cm (8")

Lowm26-Hoglund Bone Holding Clamp



67-166-18
 18.5 cm (7 1/4")

67-166-20
 20 cm (8")

Lowm26-Lambert Bone Holding Clamp

Wire Twisting Forceps
Drahtzwirbelzangen
Pinzas para torcer alambre
Pinces à torsader le fil
Pinze per ritorcere fili



67-170-15
15.5 cm (6")



67-170-18
18 cm (7")



67-172-15
15.5 cm (6")



67-172-18
18 cm (7")



67-174-15
15.5 cm (6")



67-174-18
18 cm (7")

UltraGrip™ TC Wire Twisting Forcecp

ULTRA GRIP X



67-176-20
UltraGrip™ TC Baumgartner Wire Twisting Forcecp
Overall Length 20 cm (8")

ULTRA GRIP X



67-177-15
UltraGrip™ TC Wire Twisting Forcecp
Overall Length 14.5 cm (5 3/4")

ULTRA GRIP X

Wire Twisting Forceps
 Drahtwirbelzangen
 Pinzas para torcer alambre
 Pinces à torsader le fil
 Pinze per ritorcere fili



67-180-16
UltraGrip™ TC Corwin Wire Twisting Forcep
 Overall Length 16 cm (6 ¼")



67-182-18
UltraGrip™ TC Combi Wire Twisting Forcep
 Overall Length 18.5 cm (7 ¼")



Wire Twisting Forceps, Flat Nose Pliers
 Drahtzwirbelzangen, Flachzangen
 Pinzas para torcer alambre, Alicates de pico plano
 Pincès à torsader le fil, Pincès plates
 Pinze per ritorcere fili, Tenaglie piatte



67-184-19
UltraGrip™ TC Berry Wire Twisting Forcep
 Heavy Pattern, With Tungsten Carbide Inserts
 Overall Length 19 cm (7 ½")

ULTRA GRIP X



67-186-01

67-186-02

67-186-03

UltraGrip™ Combi-Flat Nose Plier
 Parallel Grip, Compound Action
 Overall Length 18 cm (8")

ULTRA GRIP X

Flat Nose Pliers
Flachzangen
Alicates de pico plano
Pinces plates
Tenaglie piate



67-190-14
Flat Nose Plier
Overall Length 13.5 cm (5 1/4")



67-192-14
Flat Nose Plier
Overall Length 14 cm (5 1/4")



67-194-14
Flat Nose Plier
Overall Length 14 cm (5 1/4")

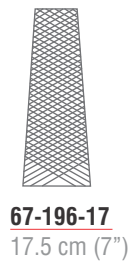

67-196-17
17.5 cm (7")

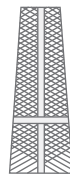

67-198-17
With Crosswise Groove
17 cm (6 3/4")



67-200-19
Flat Nose Plier
Pointed
Overall Length 19.5 cm (7 3/4")

Flat Nose Plier

Flat Nose Pliers
Flachzangen
Alicates de pico plano
Pinces plates
Tenaglie piatte



67-202-16
Flat Nose Plier
With Longitudinal Groove
Overall Length 16 cm (6 1/4")



67-204-15
Combi-Flat Nose Plier
For Bending and Cutting
Overall Length 15 cm (6")



67-210-17
Flat Nose Plier
Parallel Grip
Overall Length 18.5 cm (7 1/4")



67-212-18
Vise Grip Plier
Overall Length 20.5 cm (8")

Flat Nose Pliers
Flachzangen
Alicates de pico plano
Pinces plates
Tenaglie piatte



Combi-Flat Nose Plier
Parallel Grip, Compound Action
Overall Length 18 cm (7")



67-214-01



67-214-02

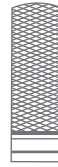

67-214-03



67-214-04
Flat Nose Plier
Overall Length 18 cm (7")

Wire Cutting Pliers
Drahtkneifzangen
Alicates para cortar alambre
Pinces à couper le fil
Tenaglie tagliafili



67-220-18
Wire Cutting Plier
For Soft Wires Up to \varnothing 2.4 mm
For Hard Wires Up to \varnothing 1.8 mm
Overall Length 18.5 cm (7 1/4")



67-222-16
Wire Cutting Plier
For Soft Wires Up to \varnothing 2.2 mm
For Hard Wires Up to \varnothing 2.0 mm
Overall Length 16 cm (6 1/4")

Wire Cutting Pliers
Drahtkneifzangen
Alicates para cortar alambre
Pinces à couper le fil
Tenaglie tagliafilii



67-230-13
UltraCut™ TC Wire Cutting Plier
For Soft Wires Up to Ø 1.5 mm
For Hard Wires Up to Ø 1.0 mm
Overall Length 13 cm (5 ¼")

ULTRACut™

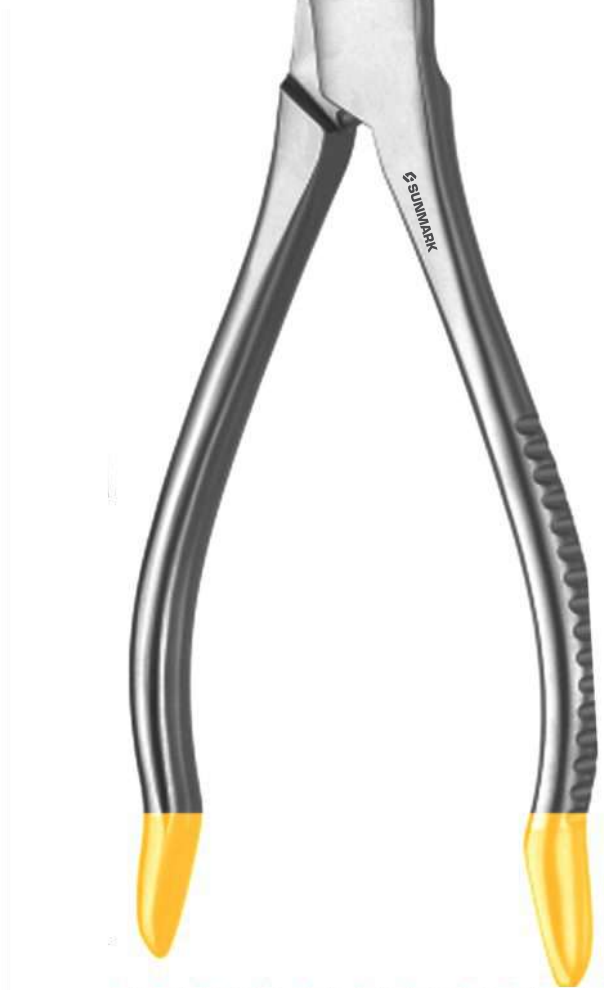

67-232-16
UltraCut™ TC Wire Cutting Plier
For Soft Wires Up to Ø 3.5 mm
For Hard Wires Up to Ø 2.5 mm
Overall Length 16.5 cm (6 ½")

ULTRACut™

Wire Cutting Pliers
Drahtkneifzangen
Alicates para cortar alambre
Pinces à couper le fil
Tenaglie tagliafili



67-234-18
For Soft Wires Up to \varnothing 2.0 mm
For Hard Wires Up to \varnothing 1.7 mm
17.5 cm (7")

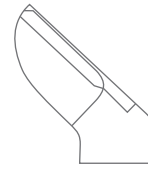

67-234-22
For Soft Wires Up to \varnothing 2.8 mm
For Hard Wires Up to \varnothing 2.2 mm
22.5 cm (8 3/4")

UltraCut™ TC Wire Cutting Plier

ULTRA.Cut™



67-236-23
UltraCut™ TC Wire Cutting Plier
For Soft Wires Up to \varnothing 3.0 mm, For Hard Wires Up to \varnothing 2.2 mm
Overall Length 23 cm (9")

ULTRA.Cut™



67-238-15
UltraCut™ TC Wire Cutting Plier
For Soft Wires Up to \varnothing 2.0 mm
For Hard Wires Up to \varnothing 1.2 mm
Overall Length 15 cm (6")

ULTRA.Cut™

Wire Cutting Pliers
Drahtkneifzangen
Alicates para cortar alambre
Pinces à couper le fil
Tenaglie tagliafilii



67-238-22
UltraCut™ TC Wire Cutting Plier
For Soft Wires Up to Ø 3.0 mm
For Hard Wires Up to Ø 2.0 mm
Overall Length 22 cm (8 ¾")

ULTRA.Cut™



67-240-47
UltraCut™ TC Wire Cutting Plier/Plate Cutter
For Wires Up to Ø 6 mm
Overall Length 47 cm (18 ½")

ULTRA.Cut™

Autopsy Instruments
Autopsie Instrumente
Instrumentos para la autopsia
Instruments pour la autopsie
Strumenti per autopsia



67-250-00
Virchow Skull Breaker
15 mm



67-252-14
Skull Breaker
Overall Length 14 cm (5 1/2")



67-254-22
Rachietome
Overall Length 22 cm (8 3/4")



67-255-18
Councilman's Chisel
Overall Length 18 cm (7")



67-256-20
20 mm

67-256-23
23 mm

Post Mortem Chisel
Overall Length 13 cm (5 1/4")



67-258-01
Left

67-258-02
Right

Brunetti Post Mortem Chisel
Overall Length 28.5 cm (11 1/4")

Bone Chisels, Gouges
Knochenmeißel, Hohlmeißel
Cinceles, Gubias
Ciseaux-burins, Gouges
Scalpelli, Sgorbie



67-260-24
Post Mortem Hammer
With Hook Handle
Overall Length 24 cm (9 1/2")



67-280-04
Bone Chisel
4.0 mm
Overall Length 17 cm (6 3/4")



67-282-04
Bone Osteotome
4.0 mm
Overall Length 17 cm (6 3/4")

Bone Chisels, Gouges
Knochenmeißel, Hohlmeißel
Cinceles, Gubias
Ciseaux-burins, Gouges
Scalpelli, Sgorbie



Gardner Bone Chisel
Triangular Shape
Overall Length 17 cm (6 3/4")

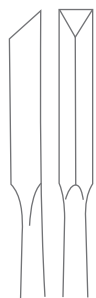

67-284-01
Straight
4.0 mm



67-284-02
Curved Right
4.0 mm



67-284-02
Curved Left
4.0 mm



Snyder-O.S.U Bone Gouge
Overall Length 16.5 cm (6 1/2")



















67-286-03
3.0 mm



67-286-05
5.0 mm







Bone Chisels, Gouges
 Knochenmeißel, Hohlmeißel
 Cinceles, Gubias
 Ciseaux-burins, Gouges
 Scalpelli, Sgorbie



					
	67-300-08 8.0 mm		67-301-08 8.0 mm		67-302-08 8.0 mm
					
	67-300-10 10.0 mm		67-301-10 10.0 mm		67-302-10 10.0 mm
					
	67-300-12 12.0 mm		67-301-12 12.0 mm		67-302-12 12.0 mm
					
	67-300-14 14.0 mm		67-301-14 14.0 mm		67-302-14 14.0 mm
					
	67-300-16 16.0 mm		67-301-16 16.0 mm		67-302-16 16.0 mm
Bone Osteotome Overall Length 13.5 cm (5 1/4")		Bone Chisel Overall Length 13.5 cm (5 1/4")		Bone Gouge Overall Length 13.5 cm (5 1/4")	







Bone Chisels, Gouges
 Knochenmeißel, Hohlmeißel
 Cinceles, Gubias
 Ciseaux-burins, Gouges
 Scalpelli, Sgorbie



-  **67-305-02**
2.0 mm
-  **67-305-03**
3.0 mm
-  **67-305-04**
4.0 mm
-  **67-305-05**
5.0 mm
-  **67-305-06**
6.0 mm
-  **67-305-07**
7.0 mm
-  **67-305-08**
8.0 mm





Partsch Bone Chisel
 Overall Length 13.5 cm (5 1/4")



-  **67-306-02**
2.0 mm
-  **67-306-03**
3.0 mm
-  **67-306-04**
4.0 mm
-  **67-306-05**
5.0 mm
-  **67-306-06**
6.0 mm
-  **67-306-07**
7.0 mm
-  **67-306-08**
8.0 mm







Partsch Bone Chisel
 Overall Length 17 cm (6 3/4")



-  **67-309-02**
2.0 mm
-  **67-309-03**
3.0 mm
-  **67-309-04**
4.0 mm
-  **67-309-05**
5.0 mm
-  **67-309-06**
6.0 mm
-  **67-309-07**
7.0 mm
-  **67-309-08**
8.0 mm

Partsch Bone Gouge
 Overall Length 13.5 cm (5 1/4")



-  **67-310-02**
2.0 mm
-  **67-310-03**
3.0 mm
-  **67-310-04**
4.0 mm
-  **67-310-05**
5.0 mm
-  **67-310-06**
6.0 mm
-  **67-310-07**
7.0 mm
-  **67-310-08**
8.0 mm

Partsch Bone Gouge
 Overall Length 17 cm (6 3/4")

Bone Chisels, Gouges
Knochenmeißel, Hohlmeißel
Cinceles, Gubias
Ciseaux-burins, Gouges
Scalpelli, Sgorbie



Alexander Bone Chisel
Overall Length 17.5 cm (7")



67-314-04
4.0 mm



67-314-06
6.0 mm



67-314-08
8.0 mm



67-314-10
10.0 mm



67-314-12
12.0 mm



67-314-14
14.0 mm



Alexander Bone Gouge
Overall Length 17.5 cm (7")



67-315-04
4.0 mm



67-315-06
6.0 mm



67-315-08
8.0 mm



67-315-10
10.0 mm



67-315-12
12.0 mm



67-315-14
14.0 mm

Osteotomes
 Osteotome
 Osteótomos
 Ostéotomes
 Osteotomi



67-320-02
2.0 mm

67-320-04
4.0 mm

67-320-08
8.0 mm

67-320-12
12.0 mm

67-320-03
3.0 mm

67-320-06
6.0 mm

67-320-10
10.0 mm

67-320-15
15.0 mm

Mini-Lambotte Bone Osteotome
 Straight
 Overall Length 12.5 cm (5")



67-322-03
3.0 mm

67-322-06
6.0 mm

67-322-10
10.0 mm

67-322-15
15.0 mm

67-322-04
4.0 mm

67-322-08
8.0 mm

67-322-12
12.0 mm

Mini-Lambotte Bone Osteotome
 Straight
 Overall Length 17 cm (6 3/4")

Osteotomes
Osteotome
Osteótomos
Ostéotomes
Osteotomi

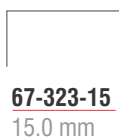
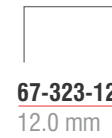
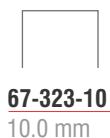
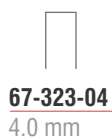

Mini-Lambotte Bone Osteotome
Curved
Overall Length 17 cm (6 3/4")

Osteotomes
 Osteotome
 Osteótomos
 Ostéotomes
 Osteotomi



67-324-04
4.0 mm



67-324-25
25.0 mm



67-324-08
8.0 mm



67-324-30
30.0 mm



67-324-10
10.0 mm



67-324-38
38.0 mm



67-324-13
13.0 mm



67-324-44
44.0 mm



67-324-15
15.0 mm



67-324-50
50.0 mm



67-324-20
20.0 mm

Lambotte Bone Osteotome
 Straight
 Overall Length 24 cm (9 1/2")

Osteotomes
 Osteotome
 Osteótomos
 Osteótomes
 Osteotomi

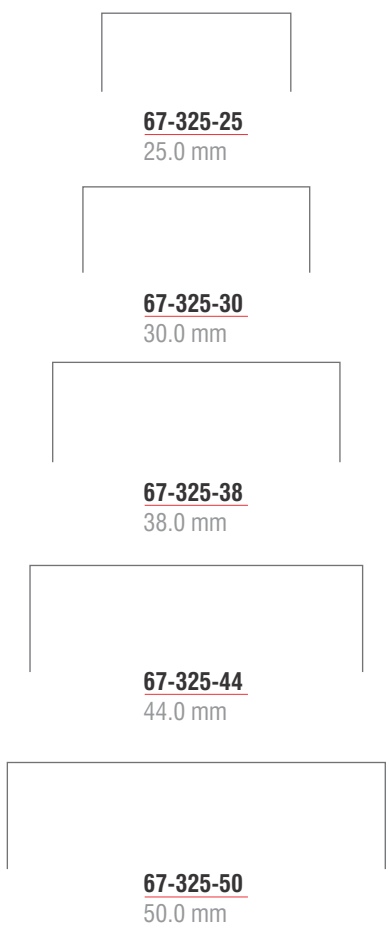

Lambotte Bone Osteotome
 Curved
 Overall Length 24 cm (9 1/2")

Chisels, Osteotomes
 Flachmeißel, Osteotome
 Cinceles, Osteótomos
 Ciseaux-burins, Ostéotomes
 Scalpelli, Osteotomi

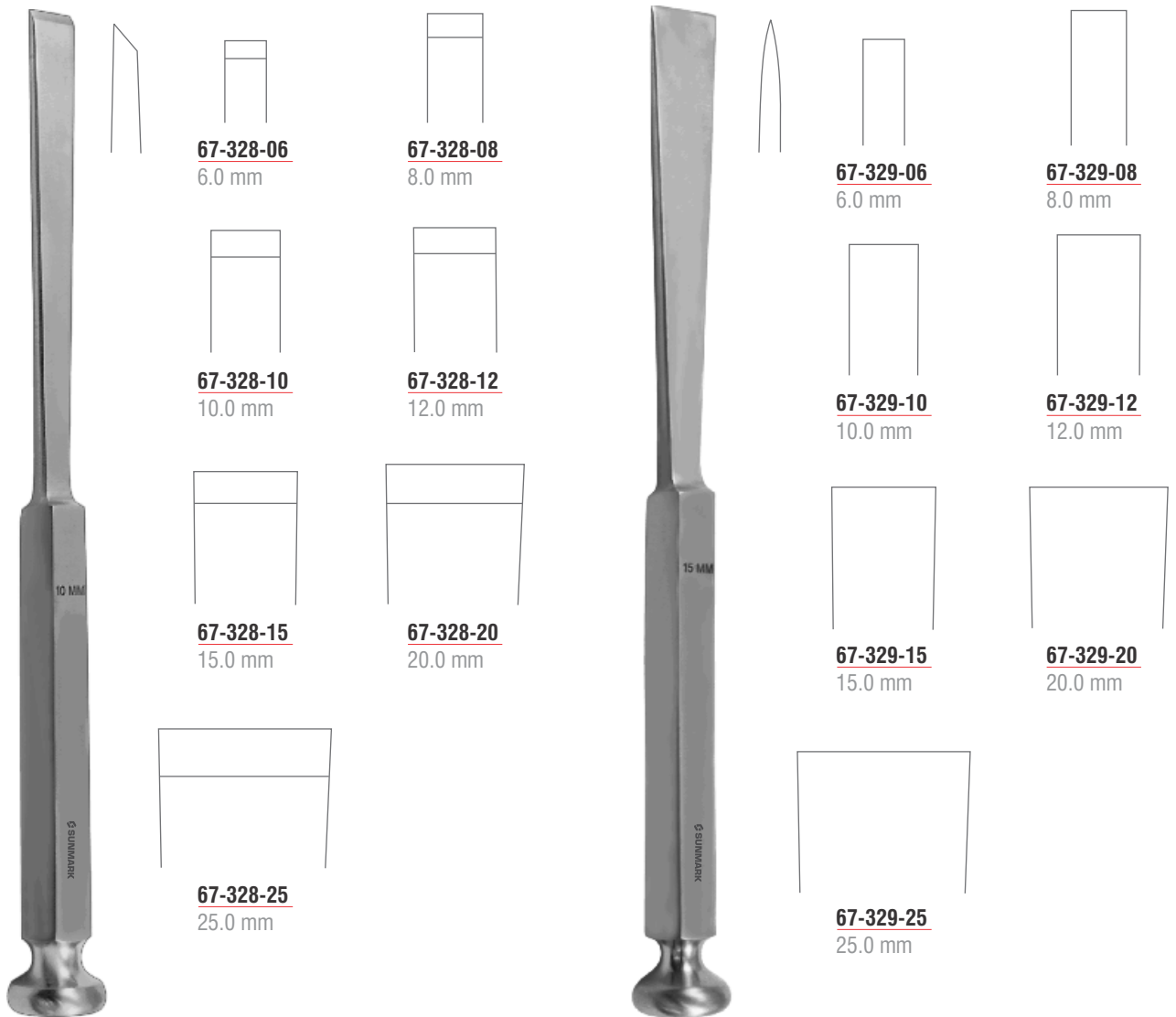

Stille Bone Chisel
 Overall Length 20 cm (8")

Stille Bone Osteotome
 Overall Length 20 cm (8")

Gouges
Hohlmeißel
Gubias
Gouges
Sgorbie



Stille Bone Gouge
Overall Length 20 cm (8")



67-330-06
6.0 mm

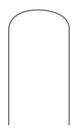

67-330-08
8.0 mm



67-330-10
Curved

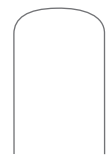

67-330-12
Curved

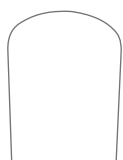

67-330-15
Curved



67-330-20
Curved

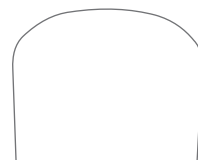

67-330-25
Curved

Osteotomes
 Osteotome
 Osteótomos
 Ostéotomes
 Osteotomi



Smith-Peterson Bone Osteotome
 Straight
 Overall Length 20.5 cm (8")

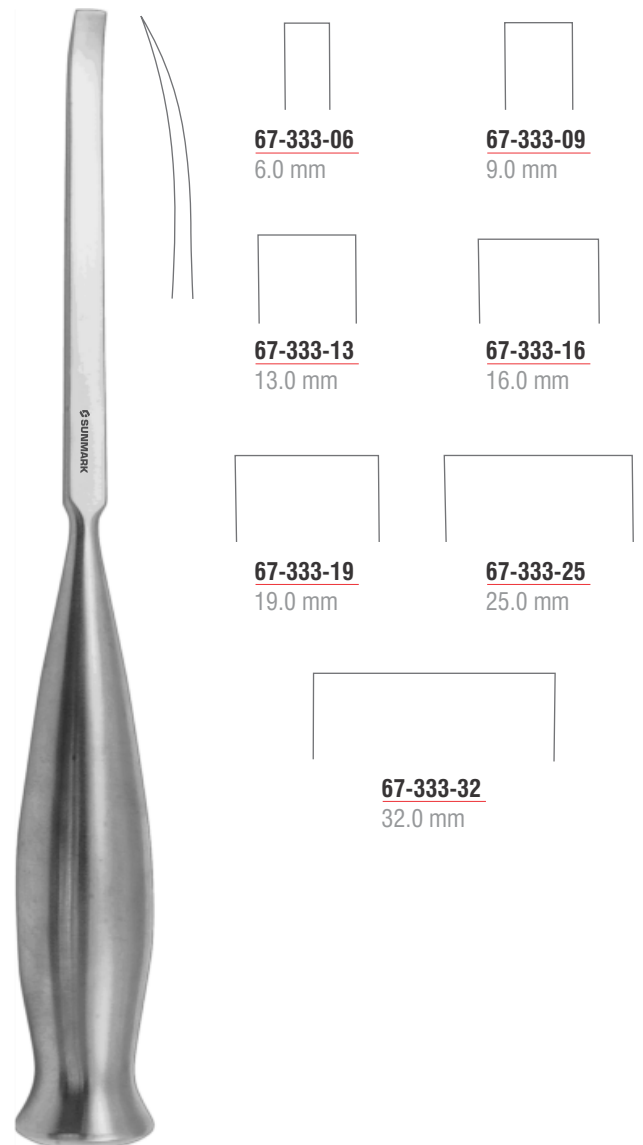

Smith-Peterson Bone Osteotome
 Curved
 Overall Length 20.5 cm (8")

Gouges
Hohlmeißel
Gubias
Gouges
Sgorbie



Smith-Peterson Bone Gouge
Straight
Overall Length 20.5 cm (8")

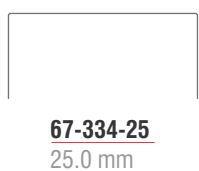
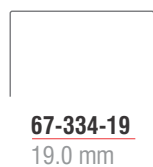
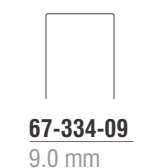

Smith-Peterson Bone Gouge
Curved
Overall Length 20.5 cm (8")

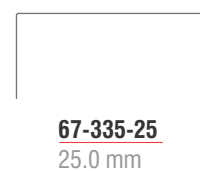
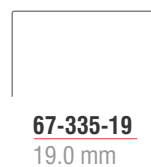

Osteotomes
 Osteotome
 Osteótomos
 Ostéotomes
 Osteotomi

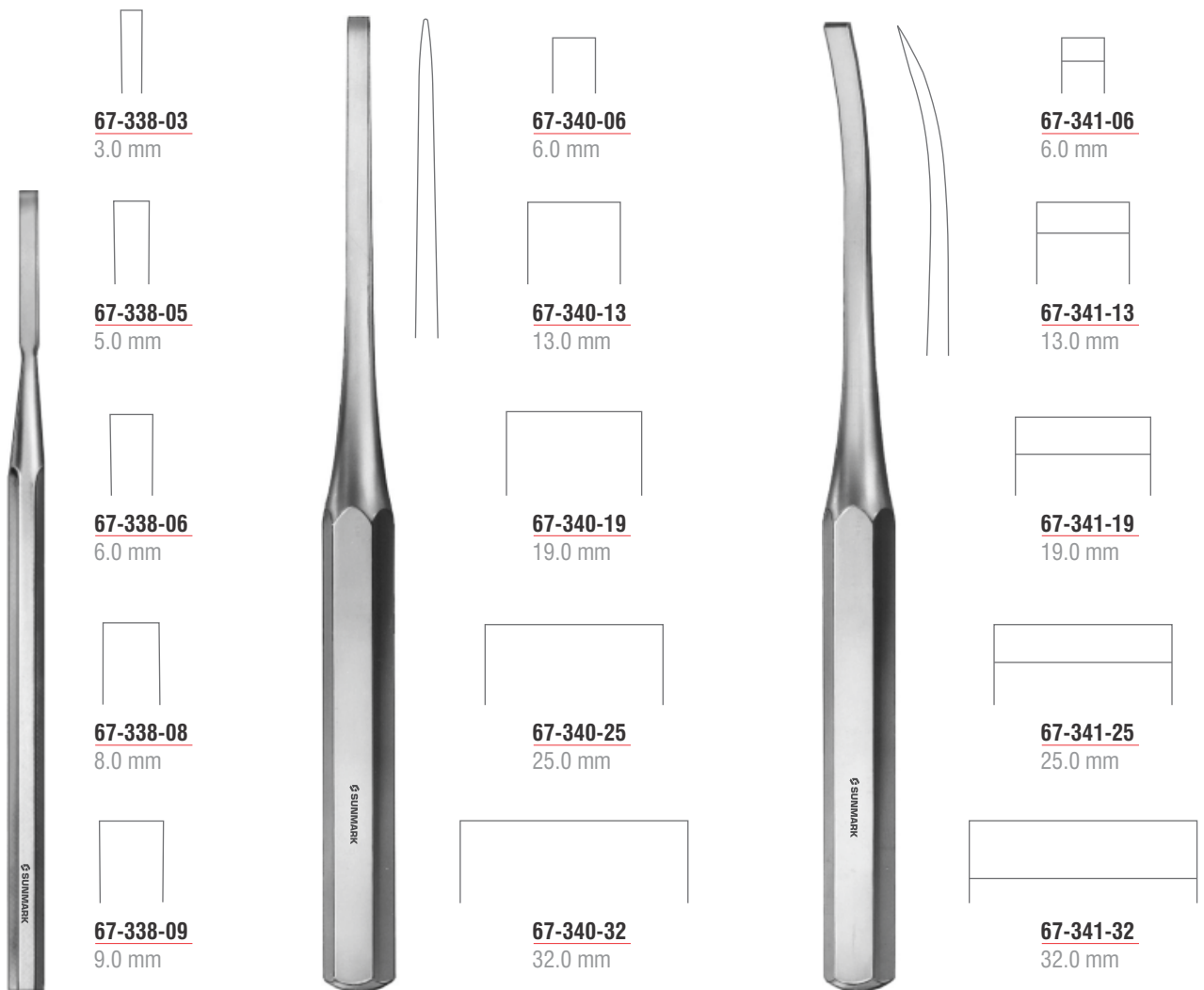

Hoke Bone Osteotome
 Overall Length 17 cm (6 3/4")

Hibbs Bone Osteotome
 Straight
 Overall Length 24.5 cm (9 3/4")

Hibbs Bone Osteotome
 Curved
 Overall Length 24.5 cm (9 3/4")

Chisels, Gouges
 Flachmeißel, Hohlmeißel
 Cinceles, Gubias
 Ciseaux-burins, Gouges
 Scalpelli, Sgorbie

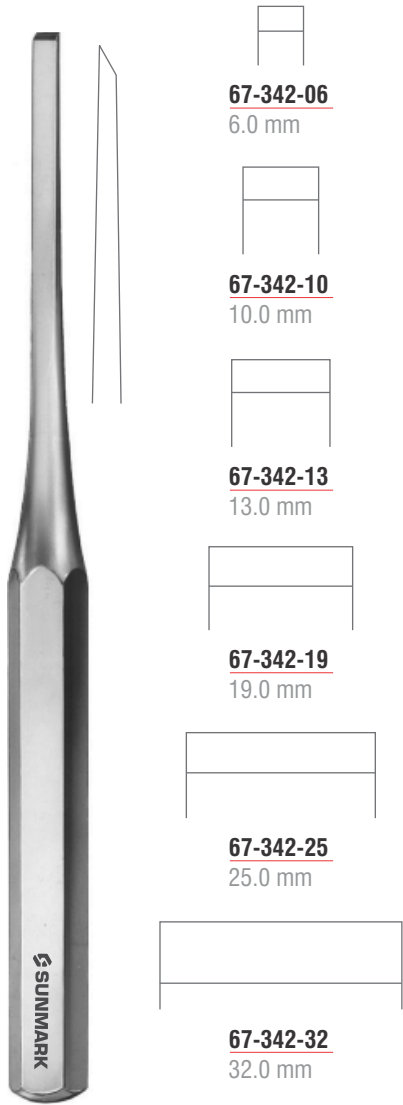

Hibbs Bone Chisel
 Overall Length 24.5 cm (9 3/4")

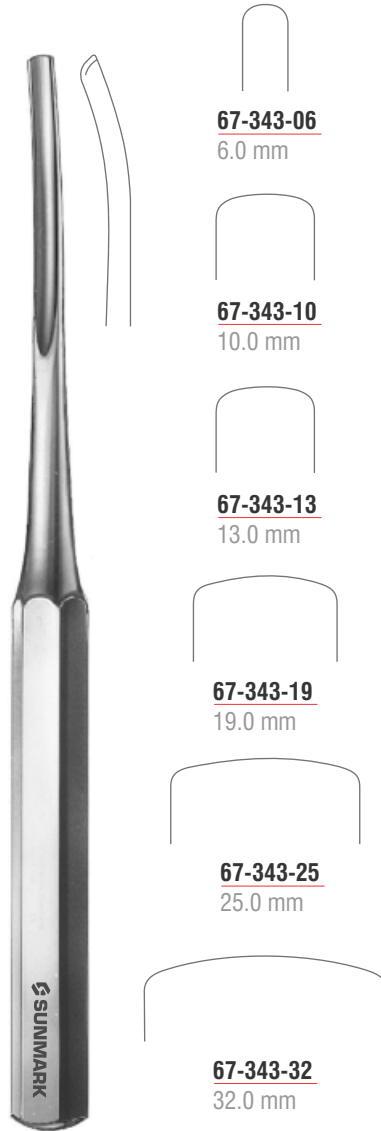

Hibbs Bone Gouge
 Curved
 Overall Length 24.5 cm (9 3/4")

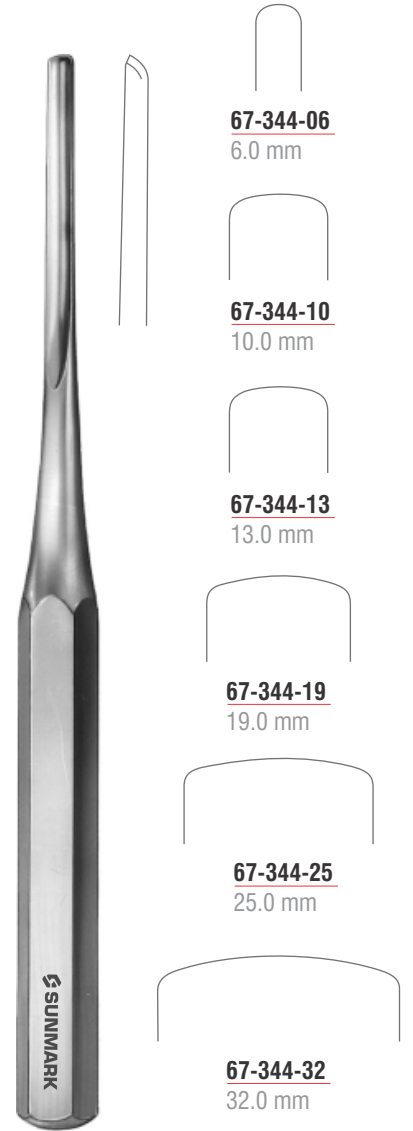

Hibbs Bone Gouge
 Straight
 Overall Length 24.5 cm (9 3/4")

Gouges, Osteotomes
 Hohlmeißel, Osteotome
 Gubias, Osteótomos
 Gouges, Ostéotomes
 Sgorbie, Osteotomi

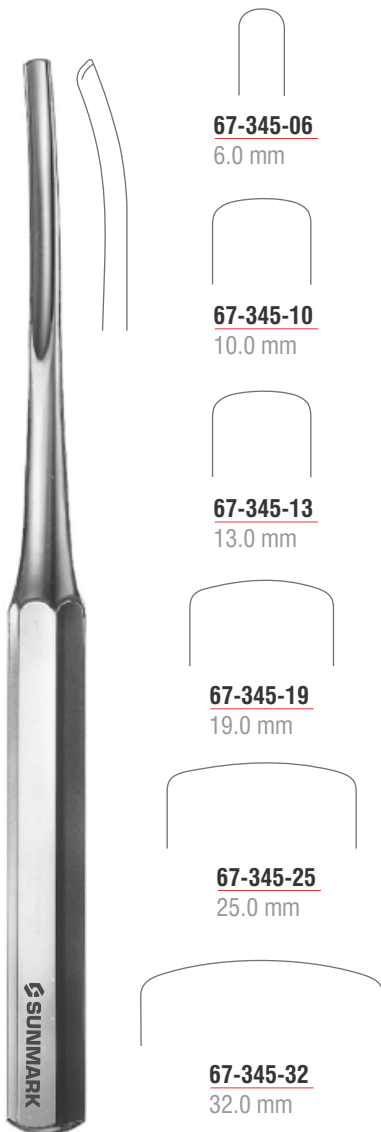

Hibbs Bone Gouge
 Curved
 Overall Length 24.5 cm (9 3/4")



Cloward Bone Osteotome
 Overall Length 24.5 cm (9 3/4")



Cloward Bone Gouge
 Overall Length 24.5 cm (9 3/4")

Gouges, Osteotomes
 Hohlmeißel, Osteotome
 Gubias, Osteótomos
 Gouges, Ostéotomes
 Sgorbie, Osteotomi



67-356-05
5.0 mm



67-356-10
10.0 mm

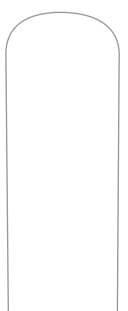

67-356-15
15.0 mm

FiberGrip™ Lexer Bone Gouge
Straight
Overall Length 25 cm (9 3/4")



67-357-05
5.0 mm

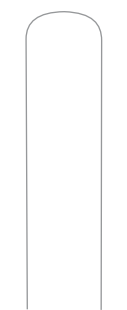

67-357-10
10.0 mm

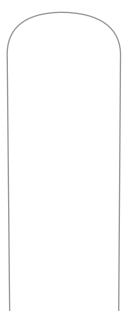

67-357-15
15.0 mm

FiberGrip™ Lexer Bone Gouge
Curved
Overall Length 25 cm (9 3/4")





Osteotomes, Gouges
 Osteotome, Hohlmeißel
 Osteótomos, Gubias
 Ostéotomes, Gouges
 Osteotomi, Sgorbie





- 

67-360-02
 2.0 mm
- 

67-360-04
 4.0 mm
- 

67-360-06
 6.0 mm
- 

67-360-08
 8.0 mm
- 

67-360-10
 10.0 mm
- 

67-360-12
 12.0 mm

FiberGrip™ Mini-Lexer Bone Osteotome
 Overall Length 18.5 cm (7 ¼")





- 

67-362-02
 2.0 mm
- 

67-362-04
 4.0 mm
- 

67-362-06
 6.0 mm
- 

67-362-08
 8.0 mm
- 

67-362-10
 10.0 mm
- 

67-362-12
 12.0 mm

FiberGrip™ Mini-Lexer Bone Gouge
 Overall Length 18.5 cm (7 ¼")



Chisels, Osteotomes
 Flachmeißel, Osteotome
 Cinceles, Osteótomos
 Ciseaux-burins, Ostéotomes
 Scalpelli, Osteotomi

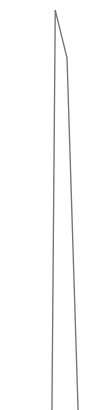

- 67-364-10**
10.0 mm
- 67-364-15**
15.0 mm
- 67-364-20**
20.0 mm
- 67-364-25**
25.0 mm
- 67-364-30**
30.0 mm

FiberGrip™ Lexer Bone Chisel
 Straight
 Overall Length 20 cm (8")



- 67-365-10**
10.0 mm
- 67-365-15**
15.0 mm
- 67-365-20**
20.0 mm

FiberGrip™ Lexer Bone Chisel
 Curved
 Overall Length 20 cm (8")

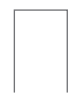

67-366-07
7.0 mm



67-366-10
10.0 mm



67-366-15
15.0 mm



67-366-20
20.0 mm



67-366-25
25.0 mm



67-366-30
30.0 mm

FiberGrip™ Lexer Bone Osteotome
 Overall Length 22 cm (8 3/4")



Gouges, Osteotomes
 Hohlmeißel, Osteotome
 Gubias, Osteótomos
 Gouges, Ostéotomes
 Sgorbie, Osteotomi



FiberGrip™ Lexer Bone Gouge
 Overall Length 22 cm (8 3/4")

FiberGrip™ Lexer Bone Osteotome
 Angled
 Overall Length 27.5 cm (10 3/4")

FiberGrip™ Lexer Bone Gouge
 Angled
 Overall Length 27.5 cm (10 3/4")



Chisels, Gouges
 Flachmeißel, Hohlmeißel
 Cinceles, Gubias
 Ciseaux-burins, Gouges
 Scalpelli, Sgorbie



67-376-24
FiberGrip™ Bone Chisel
 20 mm
 Overall Length 24.5 cm (9 3/4")



67-377-26
FiberGrip™ Bone Chisel
 Curved, 16.0 mm
 Overall Length 26.5 cm (10 1/2")



FiberGrip™ Wagner Bone Gouge
 Overall Length 34 cm (13 1/2")

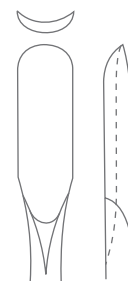

67-390-09
 Straight
 9.0 mm

67-390-15
 Straight
 15.0 mm

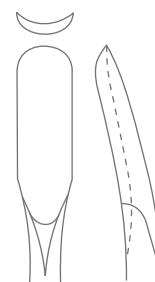

67-391-09
 Curved Forward
 9.0 mm

67-391-15
 Curved Forward
 15.0 mm

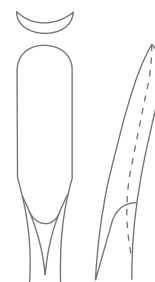

67-393-09
 Curved Backward
 9.0 mm

67-393-15
 Curved Backward
 15.0 mm

67-393-20
 Curved Backward
 20.0 mm

Gouges
Hohlmeißel
Gubias
Gouges
Sgorbie



67-395-29
FiberGrip™ Bone Gouge
25 mm
Overall Length 25 cm (9 3/4")



67-398-28
FiberGrip™ Cobb Bone Gouge
8.0 mm
Overall Length 28 cm (11")



FiberGrip™ Cobb Bone Gouge
Overall Length 28 cm (11")



67-399-01
8.0 mm

67-399-02
8.0 mm

67-399-03
8.0 mm

Gouges
Hohlmeißel
Gubias
Gouges
Sgorbie



67-402-22
FiberGrip™ Bone Gouge
9.0 mm
Overall Length 22 cm (8 3/4")



67-405-55
5.5 mm
23 cm (9")
67-405-90
9.0 mm
23.5 cm (9 1/4")



FiberGrip™ Zielke Bone Gouge



67-407-06
6.0 mm
67-407-08
8.0 mm
67-407-11
11.0 mm
67-407-16
16.0 mm



FiberGrip™ Zielke Bone Gouge
Overall Length 23.5 cm (9 1/4")

Osteotomes
 Osteotome
 Osteótomos
 Ostéotomes
 Osteotomi



- | | |
|------------------------------------|------------------------------------|
| <u>67-410-04</u>
4.0 mm | <u>67-410-12</u>
12.0 mm |
| <u>67-410-05</u>
5.0 mm | <u>67-410-15</u>
15.0 mm |
| <u>67-410-06</u>
6.0 mm | <u>67-410-20</u>
20 mm |
| <u>67-410-08</u>
8.0 mm | <u>67-410-22</u>
22 mm |
| <u>67-410-10</u>
10.0 mm | <u>67-410-25</u>
25 mm |

FiberGrip™ Dahmen Bone Osteotome
 Straight
 Overall Length 30 cm (12")



- | | |
|------------------------------------|------------------------------------|
| <u>67-411-04</u>
4.0 mm | <u>67-411-12</u>
12.0 mm |
| <u>67-411-05</u>
5.0 mm | <u>67-411-15</u>
15.0 mm |
| <u>67-411-06</u>
6.0 mm | <u>67-411-20</u>
20 mm |
| <u>67-411-08</u>
8.0 mm | <u>67-411-22</u>
22 mm |
| <u>67-411-10</u>
10.0 mm | <u>67-411-25</u>
25 mm |

FiberGrip™ Dahmen Bone Osteotome
 Curved
 Overall Length 30 cm (12")



Gouges
 Hohlmeißel
 Gubias
 Gouges
 Sgorbie



- | | |
|------------------------------------|------------------------------------|
| <u>67-412-04</u>
4.0 mm | <u>67-412-12</u>
12.0 mm |
| <u>67-412-05</u>
5.0 mm | <u>67-412-15</u>
15.0 mm |
| <u>67-412-06</u>
6.0 mm | <u>67-412-20</u>
20 mm |
| <u>67-412-08</u>
8.0 mm | <u>67-412-22</u>
22 mm |
| <u>67-412-10</u>
10.0 mm | <u>67-412-25</u>
25 mm |

FiberGrip™ Dahmen Bone Gouge
 Straight
 Overall Length 30 cm (12")

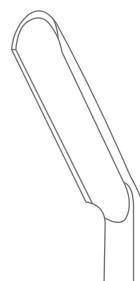

- | | |
|------------------------------------|------------------------------------|
| <u>67-413-04</u>
4.0 mm | <u>67-413-12</u>
12.0 mm |
| <u>67-413-05</u>
5.0 mm | <u>67-413-15</u>
15.0 mm |
| <u>67-413-06</u>
6.0 mm | <u>67-413-20</u>
20 mm |
| <u>67-413-08</u>
8.0 mm | <u>67-413-22</u>
22 mm |
| <u>67-413-10</u>
10.0 mm | <u>67-413-25</u>
25 mm |

FiberGrip™ Dahmen Bone Gouge
 Curved
 Overall Length 30 cm (12")



Bone Files
Knochenfeilen
Limas para huesos
Limes à os
Lime per ossa

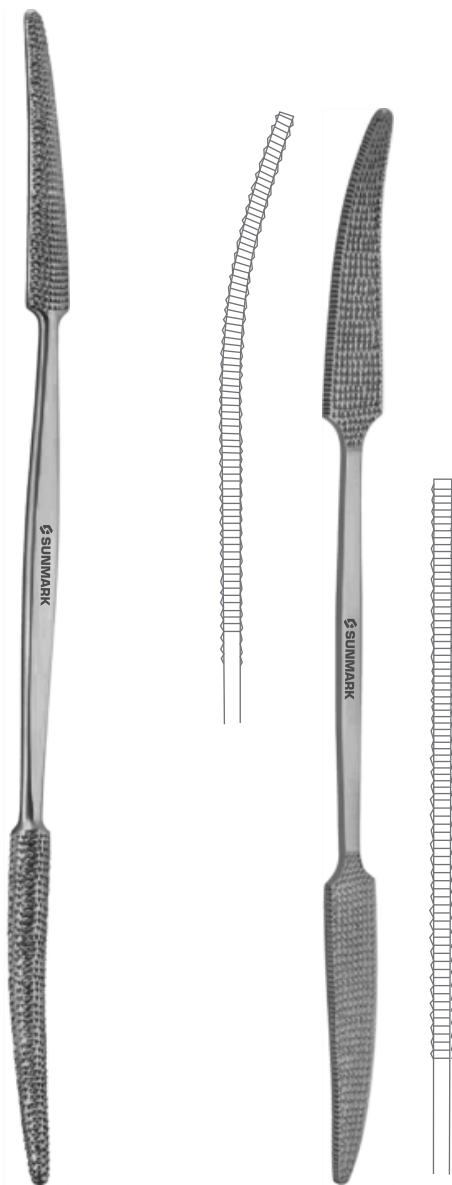

67-421-30
Putti Bone Rasp
Curved, Straight
Overall Length 30 cm (11 3/4")

67-423-27
Putti Bone Rasp
Curved, Round
Overall Length 27 cm (10 3/4")

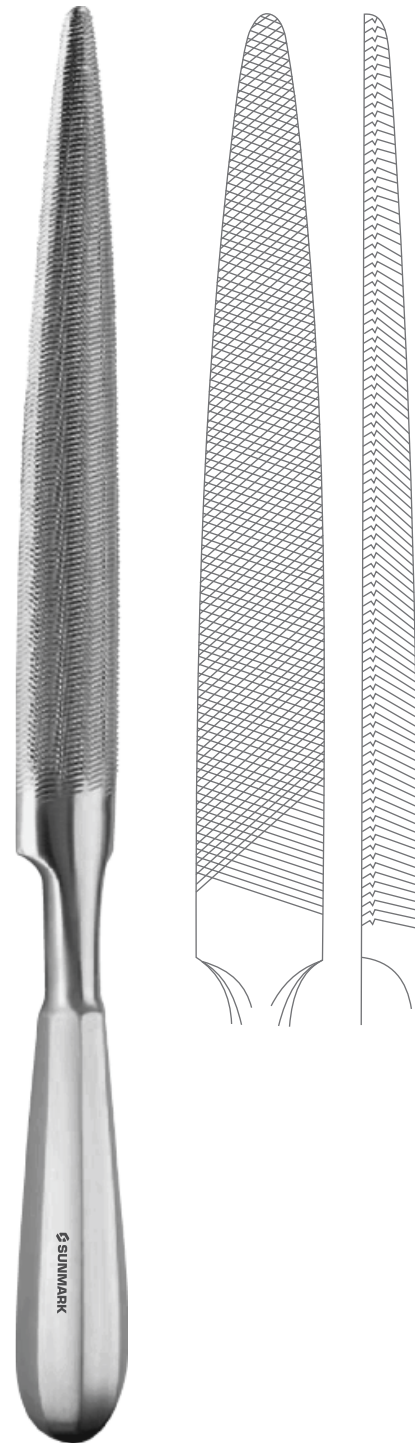

67-426-28
Bone File
Semi Round
Overall Length 28 cm (11")

Bone Files, Tampers
 Knochenfeilen, Stößel
 Limas para huesos, Punzones metálicos
 Limes à os, Pçons métalliques
 Lime per ossa, Pestoni metallici



67-427-24
Bone File
 Semi Round
 Overall Length 24.5 cm (9 3/4")



67-430-22
Bone File
 Flat
 Overall Length 22 cm (8 3/4")

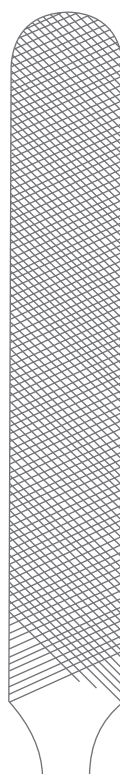

Passow Bone Tamper
 Overall Length 12 cm (4 3/4")

□ **67-438-25** 2.5 mm
 □ **67-438-35** 3.5 mm

Tampers
 Stößel
 Punzones metálicos
 Pilonis métalliques
 Pestoni metallici



67-440-02
 Ø 2.0 mm

67-440-03
 Ø 3.0 mm

67-440-04
 Ø 4.0 mm

67-440-05
 Ø 5.0 mm

67-440-06
 Ø 6.0 mm

67-440-08
 Ø 8.0 mm

67-440-10
 Ø 10.0 mm

67-442-02
 Ø 2.0 mm

67-442-05
 Ø 5.0 mm

67-442-08
 Ø 8.0 mm

67-444-12
 Ø 12.0 mm

67-444-14
 Ø 14.0 mm

67-444-16
 Ø 16.0 mm

Bone Tamper
 Overall Length 15 cm (6")

Caspar Bone Tamper
 Overall Length 20 cm (8")

Bone Tamper
 Overall Length 20 cm (8")



Tampers, Mallets
 Stößel, Hämmer
 Punzones metálicos, Martillos
 Pions métalliques, Maillets
 Pestoni metallici, Martelli



67-446-16
Worrlein Bone Tamper
 Cannulated
 Overall Length 16.5 cm (6 1/2")



67-450-01
 Ø 26.0 mm
 300 Grams

67-450-02
 Ø 28.0 mm
 340 Grams

67-450-01
 Ø 30.0 mm
 400 Grams

Williger Bone Mallet
 Lead Filled
 Overall Length 24 cm (9 1/2")



67-452-01
 Ø 25.0 mm
 120 Grams
 20.5 cm (8")

67-452-02
 Ø 30.0 mm
 180 Grams
 21 cm (8 1/4")

67-452-03
 Ø 30.0 mm
 260 Grams
 21 cm (8 1/4")

Doyen Bone Mallet

Mallets
Hämmer
Martillos
Maillets
Martelli



67-454-20
Collin Bone Mallet
Ø 30.0 mm, 220 Grams
Overall Length 20 cm (8")



67-458-21
Hajek Bone Mallet
Ø 27.0 mm, 140 Grams
Overall Length 21.5 cm (8 ½")



67-460-17
Gerzog Bone Mallet
Ø 25.0 mm, 225 Grams
Overall Length 19 cm (7 ½")



67-462-01
Ø 19.0 mm
230 Grams

67-462-02
Ø 25.0 mm
260 Grams

Lucae Bone Mallet
Overall Length 19.5 cm (7 ¾")

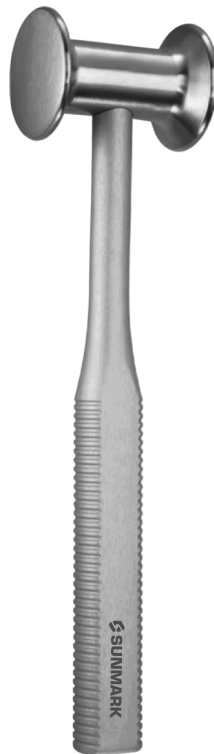

67-464-24
Bergmann Bone Mallet
Ø 45.0 mm, 300 Grams
Overall Length 24 cm (9 ½")

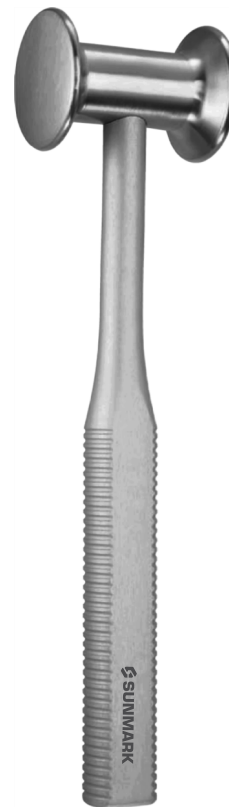

67-466-24
Bergmann Bone Mallet
Ø 30.0 mm, 245 Grams
Overall Length 23.5 cm (9 ¼")

Mallets
Hämmer
Martillos
Maillets
Martelli



67-468-24
FiberGrip™ Bone Mallet
Ø 30.0 mm, Ø 42.0 mm, 285 Grams
Overall Length 24 cm (9 ½")



67-470-19
Cottle Bone Mallet
Plain, Convex, Ø 30.0 mm, 300 Grams
Overall Length 19 cm (7 ½")



67-472-24
Omberdanne Bone Mallet
Ø 40.0 mm, 520 Grams
Overall Length 24 cm (9 ½")



67-474-18
Ø 40.0 mm
660 Grams
18.5 cm (7 ¼")

67-474-20
Ø 45.0 mm
725 Grams
20 cm (8")

Heath Bone Mallet



67-476-16
Williger Bone Mallet
Ø 20.0 mm, 140 Grams
Overall Length 16.5 cm (6 ½")



67-478-19
Mead Bone Mallet
With Interchangeable Plastic Discs
Ø 27.0 mm, 320 Grams
Overall Length 19 cm (7 ½")

Mallets
Hämmer
Martillos
Maillets
Martelli



67-478-90
Mallet Spare Plastic Discs
Pair, Plastic



67-480-18
Partsch Mallet
With Hollow Handle, Ø 22.0 mm, 200 Grams
Overall Length 19 cm (7 ½")



67-486-22
FiberGrip™ Bone Mallet
With Plastic Handle, Ø 30.0 mm, 510 Grams
Overall Length 26 cm (10 ¼")



67-488-01
FiberGrip™ Bone Mallet
With Lead Filling, Ferrozell
Ø 42.0 mm, 400 Grams
Overall Length 26 cm (10 ¼")



67-488-02
FiberGrip™ Bone Mallet
Without Lead Filling, Ferrozell
Ø 42.0 mm, 250 Grams
Overall Length 26 cm (10 ¼")



67-490-26
FiberGrip™ Bone Mallet
With Lead Filling, Ferrozell
Ø 42.0 mm, 400 Grams
Overall Length 26 cm (10 ¼")

Mallets
Hämmer
Martillos
Maillets
Martelli



67-492-29
FiberGrip™ Bone Mallet
Plane (Nylon), Convex (Stainless Steel)
Ø 30.0 mm, 675 Grams
Overall Length 26.5 cm (10 ½")



67-494-24
FiberGrip™ Bone Mallet
Plane (Nylon), Convex (Stainless Steel)
Ø 30.0 mm, 530 Grams
Overall Length 26 cm (10 ¼")



67-496-24
FiberGrip™ Bone Mallet
Ø 30.0 mm, 480 Grams
Overall Length 24 cm (9 ½")



67-498-22
FiberGrip™ Bone Mallet
With Interchangeable Plastic Discs
Ø 37.0 mm, 370 Grams
Overall Length 24 cm (9 ½")



Mallets
Hämmer
Martillos
Maillets
Martelli



67-500-18
FiberGrip™ Bone Mallet
Ø 30.0 mm, 125 Grams
Overall Length 22 cm (8 ¾")



67-502-01
Ø 30.0 mm, 450 Grams

67-502-02
Ø 50.0 mm, 900 Grams



FiberGrip™ Bone Mallet
Overall Length 26 cm (10 ½")



67-504-19
FiberGrip™ Vickers Bone Mallet
With Interchangeable Nylon Discs
Ø 25.0 mm, 300 Grams
Overall Length 19 cm (7 ½")



67-506-19
FiberGrip™ Herbert Bone Mallet
Overall Length 19 cm (7 ½")

Bone Currettes
 Scharfe Löffel
 Cucharillas cortantes
 Curettes tranchantes
 Curette taglienti



FiberGrip™ Volkmann Bone Curette
 Oval

67-520-40
 Fig. 0000
 18.5 cm (7 ¼")

67-520-30
 Fig. 000
 18.5 cm (7 ¼")

67-520-20
 Fig. 00
 18.5 cm (7 ¼")

67-520-10
 Fig. 0
 18.5 cm (7 ¼")

67-520-01
 Fig. 1
 18.5 cm (7 ¼")

67-520-02
 Fig. 2
 18.5 cm (7 ¼")

67-520-03
 Fig. 3
 19 cm (7 ½")

67-520-04
 Fig. 4
 19 cm (7 ½")

67-520-05
 Fig. 5
 19 cm (7 ½")

67-520-06
 Fig. 6
 19 cm (7 ½")



FiberGrip™ Volkmann Bone Curette
 Oval
 Overall Length 27.5 cm (10 ¾")

67-522-01
 Fig. 1

67-522-02
 Fig. 2

67-522-03
 Fig. 3

67-522-04
 Fig. 4

67-522-05
 Fig. 5

67-522-06
 Fig. 6

67-522-10
 Fig. 0

67-522-20
 Fig. 00

67-522-30
 Fig. 000

67-522-40
 Fig. 0000

Bone Curettes
Scharfe Löffel
Cucharillas cortantes
Curettes tranchantes
Curette taglianti



Volkman Bone Curette
Oval
Overall Length 17 cm (6 3/4")



67-524-30
Fig. 000
2.5 mm



67-524-10
Fig. 0
4.2 mm



67-524-02
Fig. 2
6.3 mm



67-524-04
Fig. 4
8 mm



67-524-20
Fig. 00
3.4 mm



67-524-01
Fig. 1
5.2 mm



67-524-03
Fig. 3
7.4 mm



Volkman Bone Curette
Oval
Overall Length 17 cm (6 3/4")



67-526-40
Fig. 0000
2.8 mm



67-526-10
Fig. 0
5.2 mm



67-526-03
Fig. 3
10 mm



67-526-06
Fig. 6
14.5 mm



67-526-30
Fig. 000
3.6 mm



67-526-01
Fig. 1
6.8 mm



67-526-04
Fig. 4
11.5 mm



67-526-20
Fig. 00
4.4 mm



67-526-02
Fig. 2
8.5 mm



67-526-05
Fig. 5
13 mm

Bone Curettes
 Scharfe Löffel
 Cucharillas cortantes
 Curettes tranchantes
 Curette taglienti



Bruns Bone Curette
 Round
 Overall Length 17 cm (6 3/4")



67-528-30
 Fig. 000
 3.0 mm



67-528-20
 Fig. 00
 4.0 mm



67-528-10
 Fig. 0
 5.0 mm



67-528-01
 Fig. 1
 6.0 mm



67-528-02
 Fig. 2
 8.0 mm



67-528-03
 Fig. 3
 10.0 mm



67-528-04
 Fig. 4
 12.0 mm



Bruns Bone Curette
 Round
 Overall Length 17 cm (6 3/4")



67-530-40
 Fig. 0000
 1.6 mm



67-530-30
 Fig. 000
 2.3 mm



67-530-20
 Fig. 00
 3.0 mm



67-530-10
 Fig. 0
 3.5 mm



67-530-01
 Fig. 00
 4.0 mm



67-530-02
 Fig. 0
 5.5 mm



67-530-03
 Fig. 000
 6.0 mm



67-530-04
 Fig. 00
 6.8 mm



67-530-05
 Fig. 0
 7.6 mm

Bone Currettes
 Scharfe Löffel
 Cucharillas cortantes
 Curettes tranchantes
 Curette taglienti

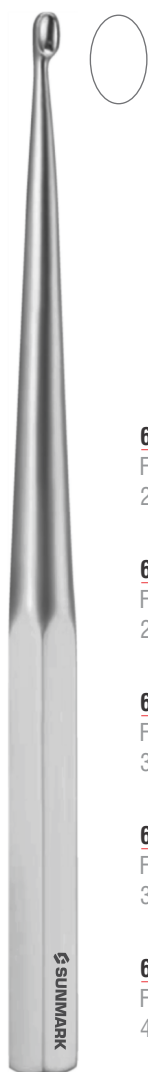

67-532-30
Fig. 000
2.0 mm

67-532-03
Fig. 3
5.3 mm

67-532-20
Fig. 00
2.5 mm

67-532-04
Fig. 4
6.0 mm

67-532-10
Fig. 0
3.3 mm

67-632-05
Fig. 5
6.7 mm

67-532-01
Fig. 1
3.8 mm

67-532-06
Fig. 6
7.3 mm

67-532-02
Fig. 2
4.8 mm

Bruns Bone Curette
 Oval, Solid Handle
 Overall Length 23 cm (9")



67-534-30
Fig. 000
3.6 mm

67-534-20
Fig. 00
4.4 mm

67-534-10
Fig. 0
5.2 mm

67-534-01
Fig. 1
6.8 mm



Oval, Straight

67-535-30
Fig. 000
3.6 mm

67-535-20
Fig. 00
4.4 mm

67-535-10
Fig. 0
5.2 mm

67-535-01
Fig. 1
6.8 mm



Oval, Curved Downwards

67-537-01
3.0 mm

67-537-02
4.0 mm

67-537-03
5.0 mm



Oval, Curved Upwards

Scoville Bone Curette
 Oval
 Overall Length 25 cm (9 3/4")

Bone Currettes
 Scharfe Löffel
 Cucharillas cortantes
 Currettes tranchantes
 Curette taglienti



Simon Bone Curette
 Oval
 Overall Length 25 cm (9 3/4")

67-538-30
 Fig. 000
 3.6 mm

67-538-20
 Fig. 00
 4.4 mm

67-538-10
 Fig. 0
 5.2 mm

67-538-01
 Fig. 1
 6.8 mm

67-538-02
 Fig. 2
 8.5 mm

67-538-03
 Fig. 3
 10 mm

67-538-04
 Fig. 4
 11.5 mm

67-638-05
 Fig. 5
 13 mm

67-538-06
 Fig. 6
 14.5 mm



Caspar Bone Curette
 Rectangular, Toothed
 Overall Length 25 cm (9 3/4")

67-540-01
 4.0 mm

67-540-02
 5.0 mm



Caspar Bone Curette
 Angled, Rectangular, Toothed
 Overall Length 25 cm (9 3/4")

67-541-01
 3.0 mm

67-541-02
 4.0 mm

Bone Currettes
 Scharfe Löffel
 Cucharillas cortantes
 Curettes tranchantes
 Curette taglianti



- | | |
|-----------------------------------|------------------------------------|
| <u>67-542-01</u>
5.0 mm | <u>67-542-06</u>
11.0 mm |
| <u>67-542-02</u>
5.5 mm | <u>67-542-07</u>
12.5 mm |
| <u>67-542-03</u>
6.4 mm | <u>67-542-08</u>
14.5 mm |
| <u>67-542-04</u>
8.0 mm | <u>67-542-09</u>
16.8 mm |
| <u>67-542-05</u>
9.0 mm | |

Hatfield Bone Curette
 Oval
 Overall Length 23 cm (9")



- | | |
|------------------------------------|------------------------------------|
| <u>67-544-01</u>
5.0 mm | <u>67-544-06</u>
11.4 mm |
| <u>67-544-02</u>
6.3 mm | <u>67-544-07</u>
12.7 mm |
| <u>67-544-03</u>
7.6 mm | <u>67-544-08</u>
14.0 mm |
| <u>67-544-04</u>
8.9 mm | <u>67-544-09</u>
15.2 mm |
| <u>67-544-05</u>
10.2 mm | |

Cobb Bone Curette
 Oval
 Overall Length 28 cm (11")



- | |
|-----------------------------------|
| <u>67-546-01</u>
Fig. 1 |
| <u>67-546-02</u>
Fig. 2 |
| <u>67-546-03</u>
Fig. 3 |
| <u>67-546-04</u>
Fig. 4 |
| <u>67-546-05</u>
Fig. 5 |
| <u>67-546-06</u>
Fig. 6 |

Modell USA Bone Curette
 Oval
 Overall Length 16 cm (6 ¼")

Bone Cures
Scharfe Löffel
Cucharillas cortantes
Curettes tranchantes
Curette taglienti



67-547-01
Fig. 1

67-547-02
Fig. 2

67-547-03
Fig. 3

67-547-04
Fig. 4

67-547-05
Fig. 5

67-547-06
Fig. 6

Modell USA Bone Curette
Oval, Left
Overall Length 15.5 cm (6")



67-548-01
Fig. 1

67-548-02
Fig. 2

67-548-03
Fig. 3

67-548-04
Fig. 4

67-548-05
Fig. 5

67-548-06
Fig. 6

Modell USA Bone Curette
Oval, Right
Overall Length 15.5 cm (6")

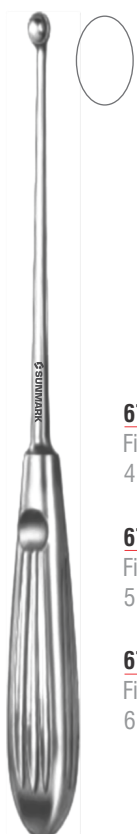

67-549-1
Fig. 000
4.4 mm

67-549-02
Fig. 00
5.2 mm

67-549-03
Fig. 0
6.8 mm

Halle Bone Curette
Oval
Overall Length 21 cm (8 1/4")



67-550-40
Fig. 0000
2.8 mm

67-550-30
Fig. 000
6.8 mm

67-550-20
Fig. 00
6.8 mm

67-550-10
Fig. 0
5.2 mm

Daubenspeck Bone Curette
Oval
Overall Length 20 cm (8")



Bone Curettes
Scharfe Löffel
Cucharillas cortantes
Curettes tranchantes
Curette taglienti



67-552-13
12.5 cm (5")



67-552-14
14.5 cm (5 3/4")



67-552-17
17 cm (6 3/4")



Volkman Bone Curette
Double Ended, Oval/Oval



Ø 6.5 mm

67-554-13
13 cm (5")

6.0 mm

Ø 9.0 mm

67-554-16
16 cm (6 1/4")

7.0 mm

Ø 11.0 mm

67-554-20
20 cm (8")

9.0 mm

Volkman Bone Curette
Double Ended, Round/Oval



Bone Currettes
 Scharfe Löffel
 Cucharillas cortantes
 Curettes tranchantes
 Curette taglienti



67-556-21
Bone Curette
 Double Ended, Round/Oval
 Overall Length 21 cm (8 1/4")

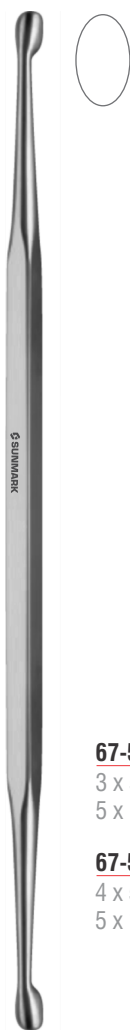

67-557-01
 3 x 5 mm /
 5 x 10 mm

67-557-02
 4 x 5 mm /
 5 x 12 mm

Volkmann Bone Curette
 Double Ended, Oval/Oval
 Overall Length 22 cm (8 1/2")



67-558-00
 Fig. 00 / Fig. 0

67-558-01
 Fig. 0 / Fig. 1

67-558-12
 Fig. 1 / Fig. 2

Williger Bone Curette
 Double Ended, Oval/Oval
 Overall Length 13.5 cm (5 1/4")



67-559-00
 Fig. 00 / Fig. 0

67-559-10
 Fig. 0 / Fig. 1

67-559-11
 Fig. 1 / Fig. 2

Williger Bone Curette
 Double Ended, Oval/Oval
 Overall Length 17 cm (6 3/4")

Bone Curettes
 Scharfe Löffel
 Cucharillas cortantes
 Curettes tranchantes
 Curette taglienti



67-561-16
Bone Curette
 Overall Length 16 cm (6 1/4")



67-563-16
Jansen Bone Curette
 Overall Length 16 cm (6 1/4")



67-565-16
Hemingway Bone Curette
 Overall Length 17 cm (6 3/4")



67-567-16
Hemingway Bone Curette
 Overall Length 17 cm (6 3/4")

Bone Currettes
Scharfe Löffel
Cucharillas cortantes
Currettes tranchantes
Curette taglianti



Hemingway Bone Curette
Overall Length 17 cm (6 3/4")

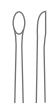

67-569-00
Fig. 0



67-569-01
Fig. 1



67-569-02
Fig. 2

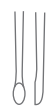

67-569-03
Fig. 3



67-569-04
Fig. 4

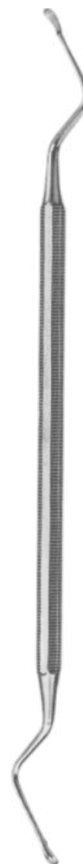

Lucas Bone Curette



67-571-18
18 cm (7")



67-573-18
18.5 cm (7 1/4")



Kerpel Bone Curette
Overall Length 14.5 cm (5 3/4")



67-575-01
Oval, Left



67-575-02
Oval, Left



67-577-01
Oval, Right



67-577-02
Oval, Right

Bone Curettes, Periosteal Elevators
 Scharfe Löffel, Raspatorien
 Cucharillas cortantes, Periostótomos
 Curettes tranchantes, Rugines-raspatoires
 Curette taglianti, Periostotomi



67-580-01

Fig. 1

67-580-02

Fig. 2

67-580-03

Fig. 3

67-580-04

Fig. 4

67-580-05

Fig. 5

67-580-06

Fig. 6

Molt Bone Curette
 Overall Length 17 cm (6 3/4")



67-582-24
Molt Bone Curette
 Round Handle
 Overall Length 19 cm (7 1/2")



67-591-32
 3.2 mm

67-591-46
 4.6 mm

Partsch Periosteal Raspatory/Elevator
 Overall Length 15 cm (6")

Periosteal Elevators
Raspatorien
Periostótomos
Rugines-raspatoires
Periostotomi



67-593-15
Partsch Mod. Lange Periosteal Raspatory/Elevator
4.0 mm
Overall Length 14.5 cm (5 3/4")

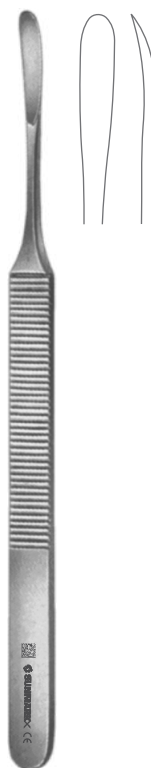

67-595-15
Koenig Periosteal Raspatory/Elevator
Overall Length 15.5 cm (6")



67-597-15
Trelat Periosteal Raspatory/Elevator
Overall Length 15.5 cm (6")



67-599-17
Ward Periosteal Raspatory/Elevator
Overall Length 17 cm (6 3/4")



67-601-20
Sewall Periosteal Raspatory/Elevator
Overall Length 20 cm (8")

Periosteal Elevators
Raspatorien
Periostótomos
Rugines-raspatoires
Periostotomi

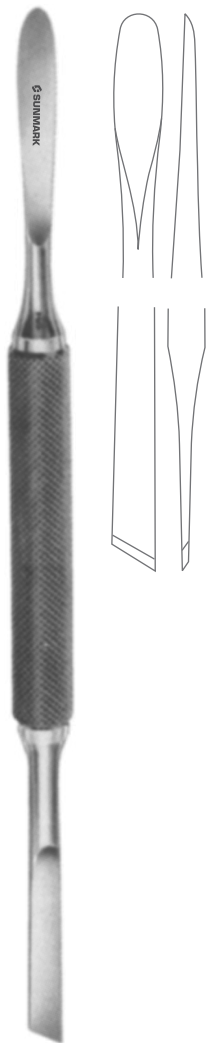

67-602-16
Mead Periosteal Raspatory/Elevator
Overall Length 16.5 cm (6 ½")

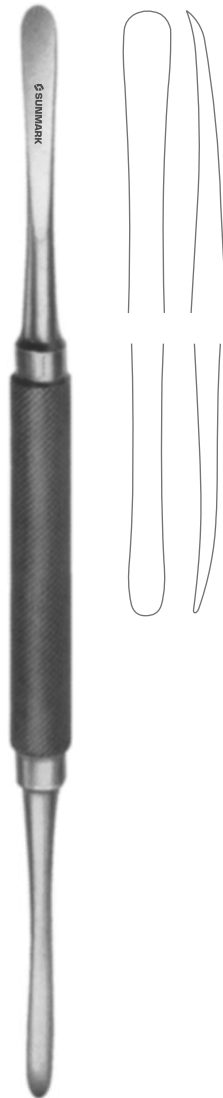

67-603-18
Molt Periosteal Raspatory/Elevator
Overall Length 18 cm (7")



67-605-18
Syme Periosteal Raspatory/Elevator
4.0 mm
Overall Length 18.5 cm (7 ¼")

Periosteal Elevators
Raspatorien
Periostótomos
Rugines-raspatoires
Periostotomi

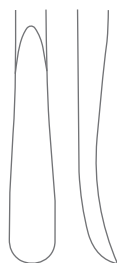
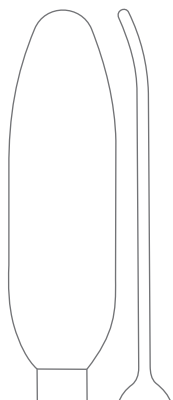

67-607-18
Roberts Periosteal Raspatory/Elevator
Overall Length 18.5 cm (7 1/4")

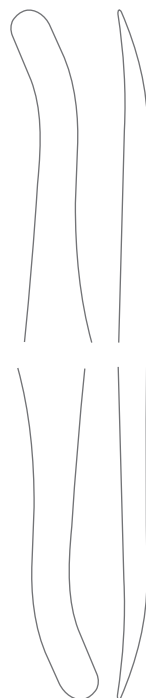

67-609-19
Seldin Periosteal Raspatory/Elevator
Overall Length 19.5 cm (7 3/4")

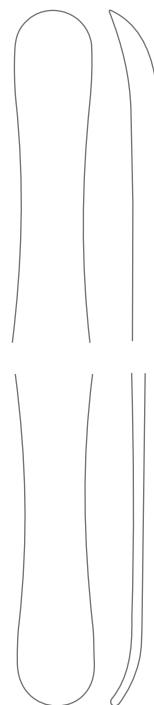

67-611-19
Seldin Periosteal Raspatory/Elevator
Overall Length 19.5 cm (7 3/4")

Periosteal Elevators
Raspatorien
Periostótomos
Rugines-raspatoires
Periostotomi



67-613-19
Cottle Periosteal Raspatory/Elevator
8.0 mm
Overall Length 19.5 cm (7 3/4")

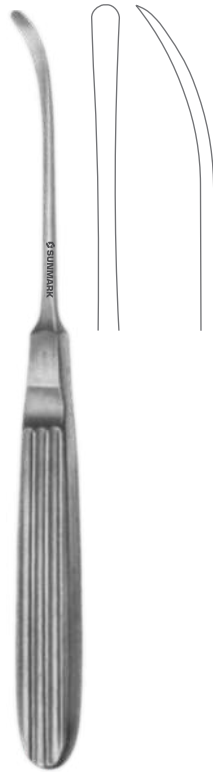

67-615-17
Landolt Periosteal Raspatory/Elevator
Overall Length 18 cm (7")

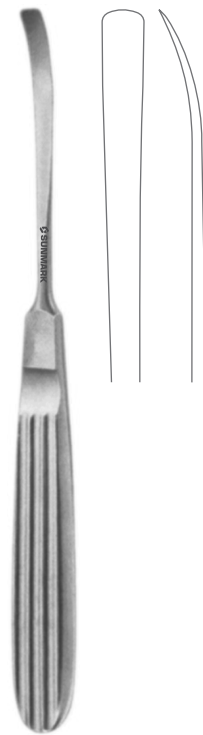

67-617-18
Caspar Periosteal Raspatory/Elevator
Overall Length 18 cm (7")

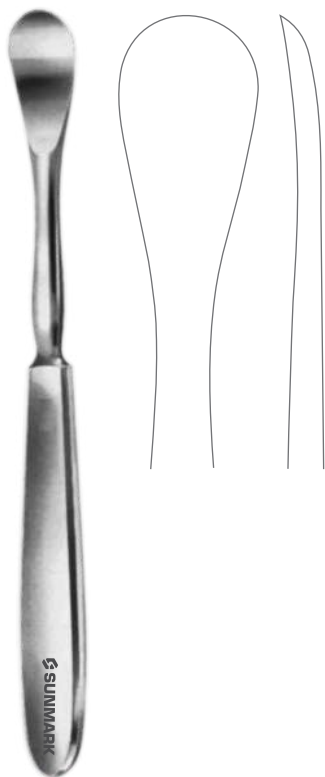

67-619-18
Sedillot Periosteal Raspatory / Elevator
18 mm
Overall Length 18.5 cm (7 1/4")



67-620-19
Cottle Periosteal Raspatory/Elevator
11.0 mm
Overall Length 19.5 cm (7 3/4")

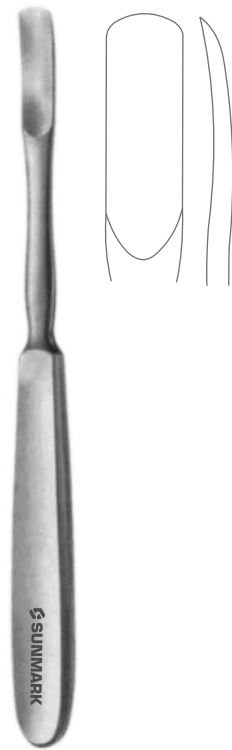

67-621-18
Kraemer Periosteal Raspatory/Elevator
10.0 mm
Overall Length 18.5 cm (7 1/4")

Periosteal Elevators
Raspatorien
Periostótomos
Rugines-raspatoires
Periostotomi

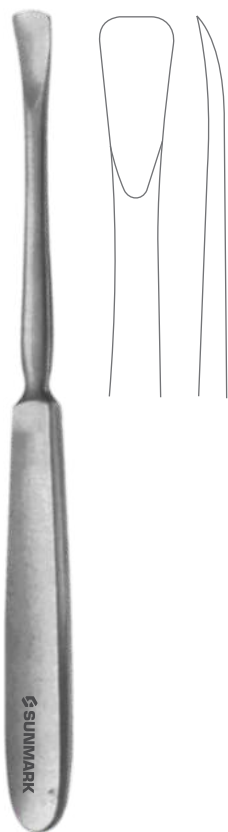

67-623-19
Kraemer Periosteal Raspatory/Elevator
10.0 mm
Overall Length 19 cm (7 ½")

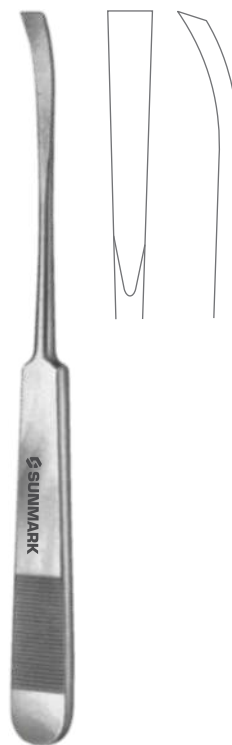

67-625-16
Pennybaker Periosteal Raspatory/Elevator
Blunt, 6.0 mm
Overall Length 16.5 cm (6 ½")

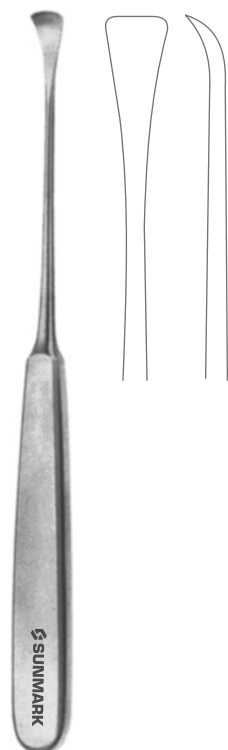

67-627-19
Buchs Periosteal Raspatory/Elevator
9.5 mm
Overall Length 19 cm (7 ½")

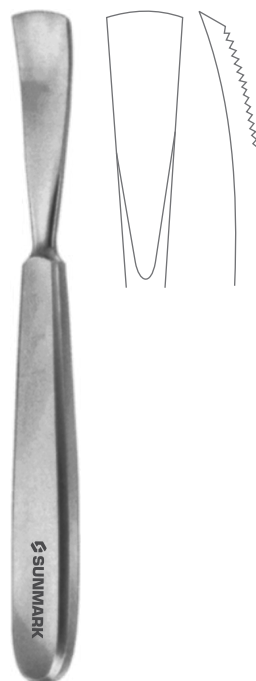

67-629-16
Jansen Periosteal Raspatory/Elevator
15.0 mm
Overall Length 16.5 cm (6 ½")

Periosteal Elevators
Raspatorien
Periostótomos
Rugines-raspatoires
Periostotomi



67-631-06

6.0 mm
18 cm (7")

67-631-10

10.0 mm
19 cm (7 1/2")

67-631-13

13.0 mm
19 cm (7 1/2")

67-631-19

19.0 mm
20 cm (8")

67-631-25

25.0 mm
21 cm (8 1/4")

Key Periosteal Raspatory/Elevator



67-633-09

McGlamry Periosteal Raspatory/Elevator
9 mm
Overall Length 17 cm (6 3/4")

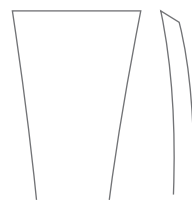

67-635-01

16 mm
19 cm (7 1/2")

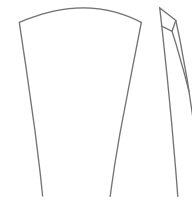

67-635-02

16 mm
19 cm (7 1/2")

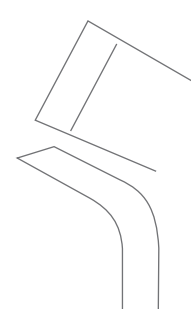

67-635-03

12 mm
18.5 cm (7 1/4")

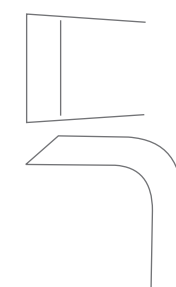

67-635-04

12 mm
18 cm (7")

Langenbeck Periosteal Raspatory/Elevator

Periosteal Elevators
 Raspatorien
 Periostótomos
 Rugines-raspatoires
 Periostotomi

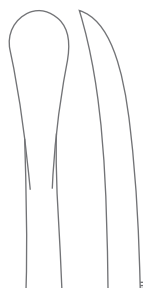

67-637-01
 7.0 mm
 16 cm (6 1/4")

67-637-02
 15.0 mm
 18.5 cm (7 1/4")

67-637-03
 20.0 mm
 19 cm (7 1/2")

Hoen Periosteal Raspatory/Elevator

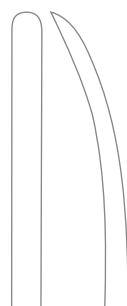

67-639-01
 4 mm
 17 cm (7")



67-639-02
 5 mm
 17.5 cm (7")



67-639-03
 6 mm
 19.5 cm (7 3/4")



67-639-04
 7 mm
 19.5 cm (7 3/4")

Cushing Periosteal Raspatory/Elevator

Periosteal Elevators
 Raspatorien
 Periostótomos
 Rugines-raspatoires
 Periostotomi

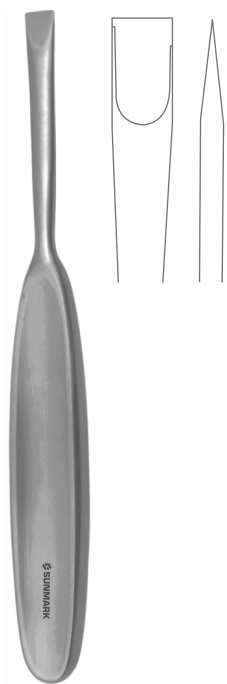

67-640-17
Martin-Cushing Periosteal Raspatory/Elevator
 8 mm
 Overall Length 17 cm (6 3/4")

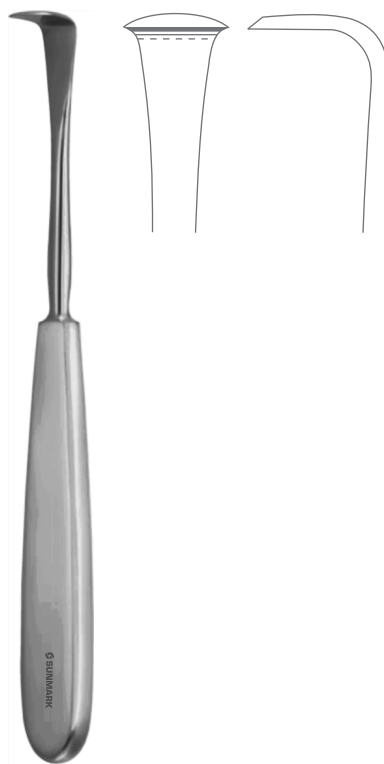

67-641-18
Langenbeck Periosteal Raspatory/Elevator
 14 mm
 Overall Length 18 cm (7")

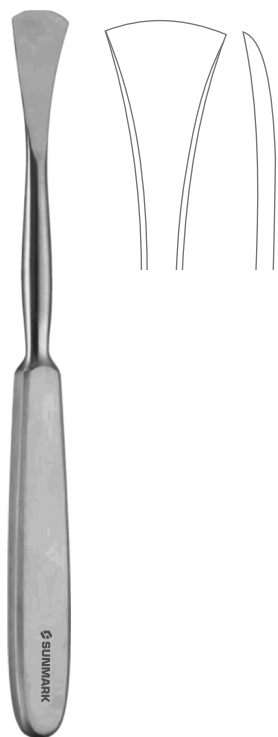

67-643-19
Langenbeck Periosteal Raspatory/Elevator
 16 mm
 Overall Length 19.5 cm (7 3/4")

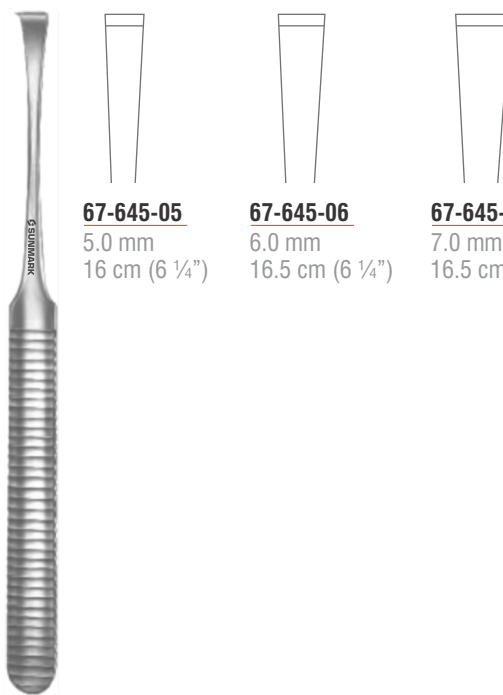

67-645-05 5.0 mm 16 cm (6 1/4")	67-645-06 6.0 mm 16.5 cm (6 1/4")	67-645-07 7.0 mm 16.5 cm (6 1/4")
--	--	--

Langenbeck Periosteal Raspatory/Elevator

Periosteal Elevators
Raspatorien
Periostótomos
Rugines-raspatoires
Periostotomi

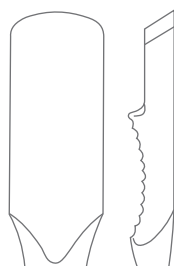

67-648-15

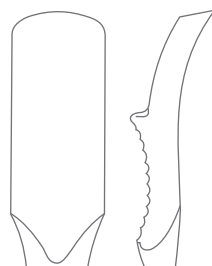

67-649-15

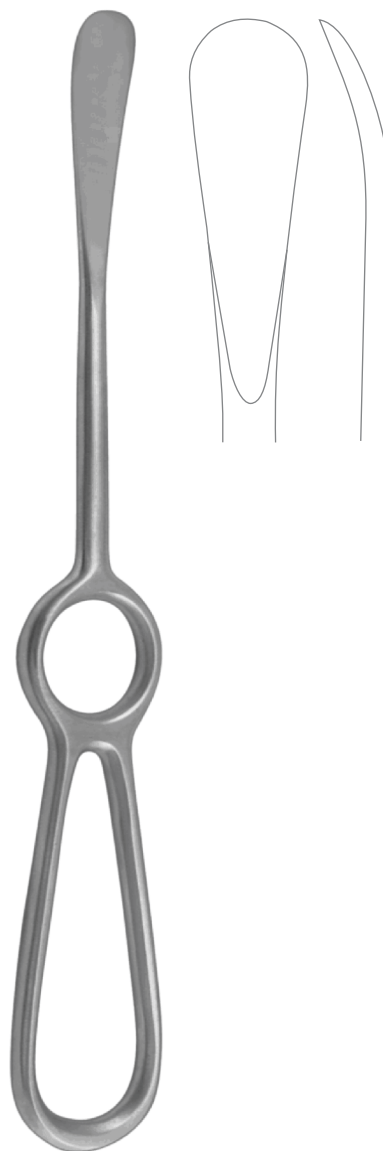

67-651-21

Sedillot Periosteal Raspatory/Elevator

15 mm

Overall Length 22 cm (8 3/4")

Farabeuf Periosteal Raspatory / Elevator

12.5 mm

Overall Length 15 cm (6")

Periosteal Elevators
Raspatorien
Periostótomos
Rugines-raspatoires
Periostotomi



67-654-19
FiberGrip™ Periosteal Raspatory/Elevator
6 mm
Overall Length 19 cm (7 1/2")



67-655-20
FiberGrip™ Periosteal Raspatory/Elevator
14 mm
Overall Length 20 cm (8")



67-657-20
FiberGrip™ Periosteal Raspatory/Elevator
14 mm
Overall Length 19 cm (7 1/2")



67-659-18
FiberGrip™ Periosteal Raspatory/Elevator
6 mm
Overall Length 18 cm (7")



Periosteal Elevators
Raspatorien
Periostótomos
Rugines-raspatoires
Periostotomi



67-661-18
FiberGrip™ Periosteal Raspatory/Elevator
6 mm
Overall Length 18 cm (7")



67-663-18
FiberGrip™ Periosteal Raspatory/Elevator
3 mm
Overall Length 18 cm (7")

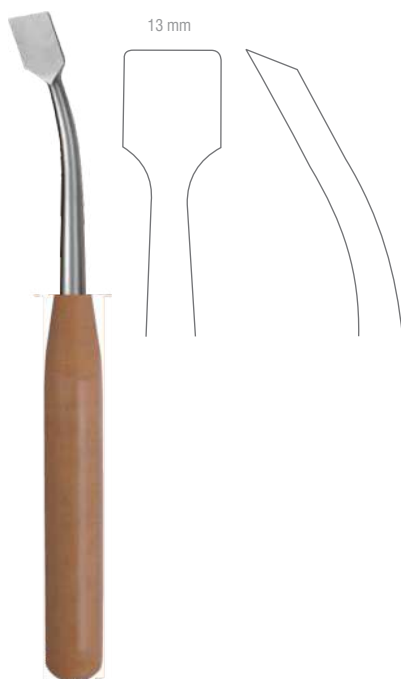

67-665-17
FiberGrip™ Periosteal Raspatory/Elevator
13 mm
Overall Length 18.5 cm (7")

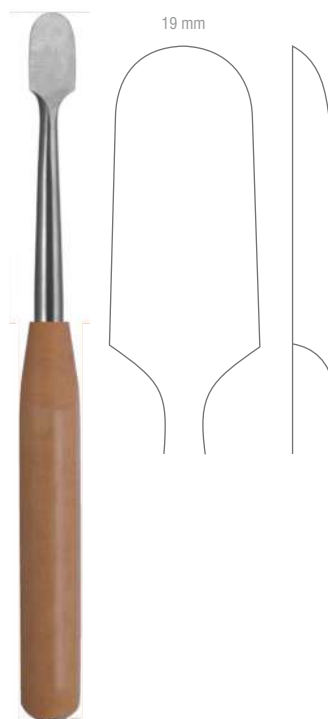

67-666-20
FiberGrip™ Periosteal Raspatory/Elevator
19 mm
Overall Length 20 cm (8")



Periosteal Elevators
 Raspatorien
 Periostótomos
 Rugines-raspatoires
 Periostotomi



67-661-18
 FiberGrip™ Periosteal Raspatory/Elevator
 6.0 mm
 Overall Length 18 cm (7")



67-663-18
 FiberGrip™ Periosteal Raspatory/Elevator
 3.0 mm
 Overall Length 18 cm (7")



67-665-17
 FiberGrip™ Periosteal Raspatory/Elevator
 13.0 mm
 Overall Length 18.5 cm (7")



67-666-20
 FiberGrip™ Periosteal Raspatory/Elevator
 19.0 mm
 Overall Length 20 cm (8")



Periosteal Elevators
Raspatorien
Periostótomos
Rugines-raspatoires
Periostotomi

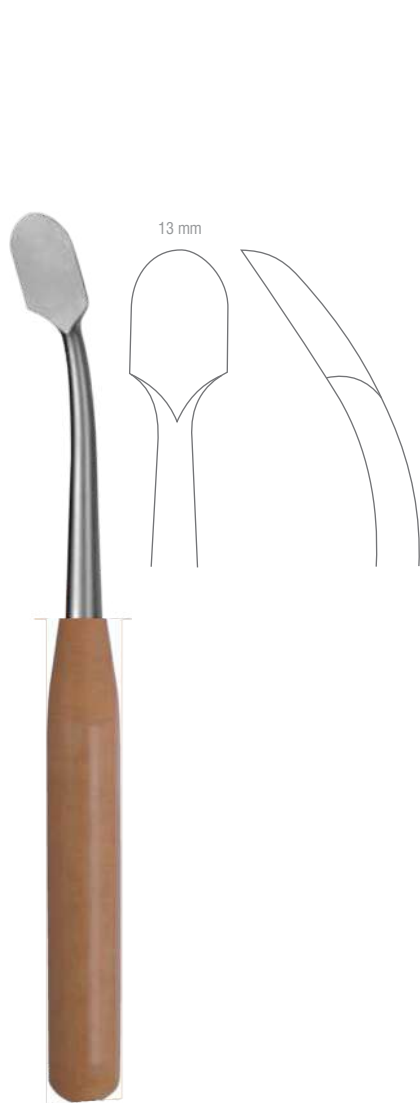

67-667-18
FiberGrip™ Periosteal Raspatory/Elevator
13 mm
Overall Length 18 cm (7")



67-669-27
FiberGrip™ Periosteal Raspatory/Elevator
20 mm
Overall Length 27 cm (10 3/4")



Periosteal Elevators
Raspatorien
Periostótomos
Rugines-raspatoires
Periostotomi



67-671-08
8 mm

67-671-17
17 mm

67-673-13
Williger Periosteal Raspatory/Elevator
5 mm
Overall Length 12.5 cm (5")

FiberGrip™ Wagner Periosteal Raspatory/Elevator
Overall Length 33 cm (13")



Periosteal Elevators
Raspatorien
Periostótomos
Rugines-raspatoires
Periostotomi



Kahre-Williger Periosteal Raspatory/Elevator
Overall Length 16 cm (6 1/4")

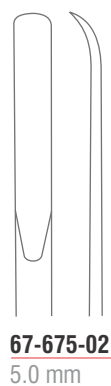

Williger Periosteal Raspatory/Elevator
Overall Length 16 cm (6 1/4")



Periosteal Elevators
 Raspatorien
 Periostótomos
 Rugines-raspatoires
 Periostotomi

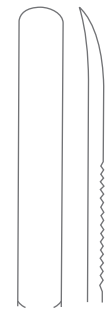

67-679-06
6.0 mm

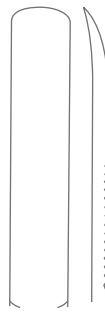

67-679-08
8.0 mm

Periosteal Raspatory/Elevator

Overall Length 17 cm (6 3/4")

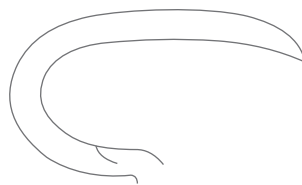

67-680-01
For Adults
Curved Right



67-680-02
For Adults
Curved Left



67-681-01
For Children
Curved Right



67-681-02
For Children
Curved Left

Doyen Rib Raspatory

Overall Length 17.5 cm (7")

Periosteal Elevators
Raspatorien
Periostótomos
Rugines-raspatoires
Periostotomi



67-682-01
Overholt Rib Raspatory/Elevator
Fig. 1
Overall Length 29 cm (11 1/2")



67-682-02
Overholt Rib Raspatory/Elevator
Fig. 2
Overall Length 27 cm (10 1/4")



67-682-21
Alexander Periosteotome
Overall Length 21 cm (8 1/4")



67-682-22
Matson Rib Elevator and Spreader
Overall Length 22.5 cm (8 3/4")

Periosteal Elevators
Raspatorien
Periostótomos
Rugines-raspatoires
Periostotomi

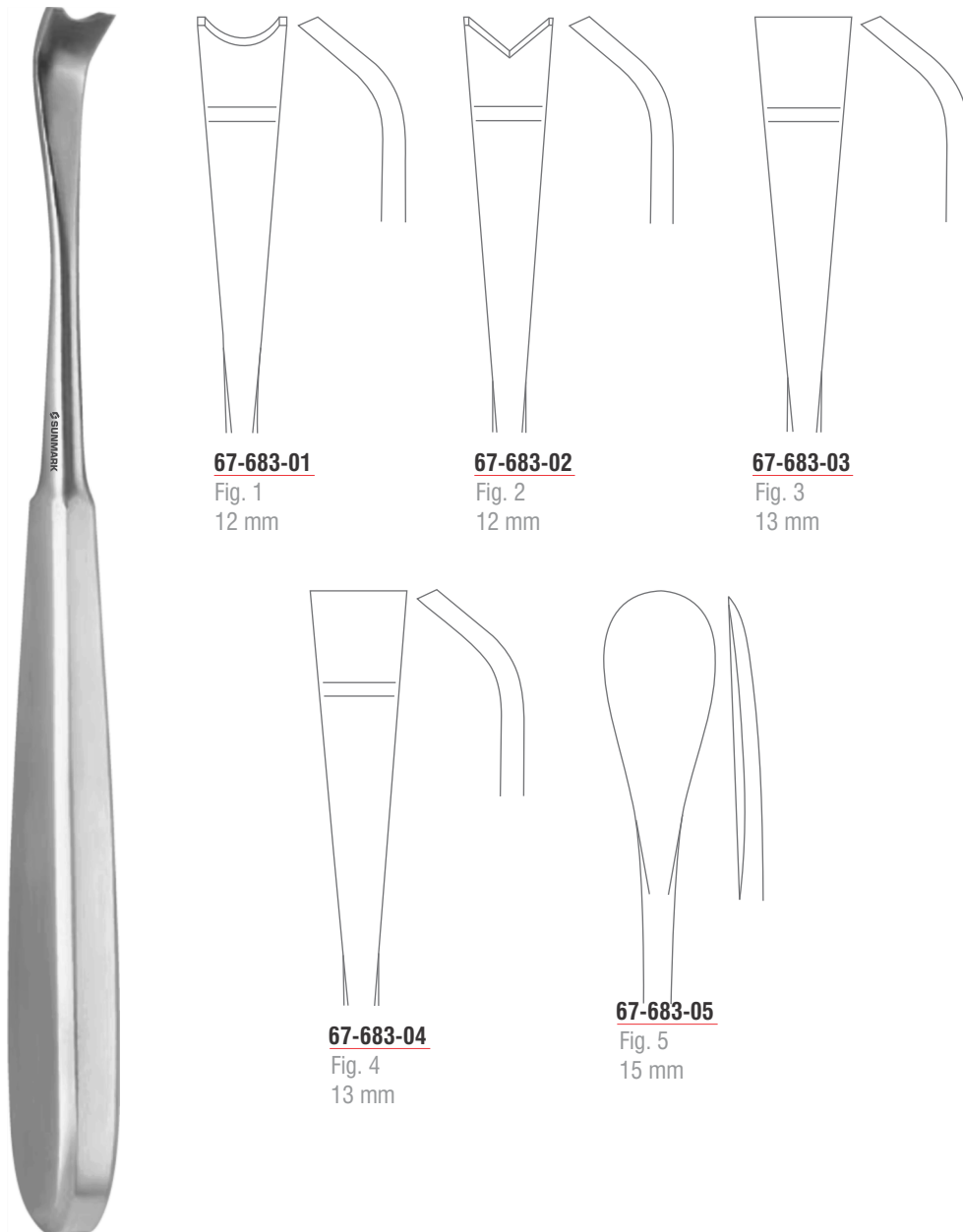

67-683-01

Fig. 1
12 mm

67-683-02

Fig. 2
12 mm

67-683-03

Fig. 3
13 mm

67-683-04

Fig. 4
13 mm

67-683-05

Fig. 5
15 mm

Semb Periosteal Raspatory/Elevator
Overall Length 18.5 cm (7 1/4")

Periosteal Elevators
Raspatorien
Periostótomos
Rugines-raspatoires
Periostotomi



67-684-10
10 mm



67-684-15
15 mm

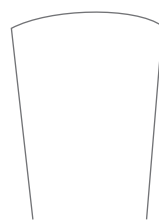

67-684-20
20 mm

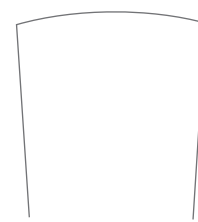

67-684-25
25 mm

Lambotte Periosteal Raspatory/Elevator
Overall Length 21.5 cm (8 1/2")

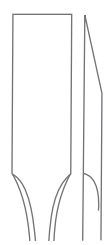

67-685-01
7.9 mm



67-685-02
5.0 mm



67-685-03
7.7 mm



67-685-04
6.3 mm

Adson Periosteal Raspatory/Elevator
Overall Length 17 cm (6 3/4")

Periosteal Elevators
Raspatorien
Periostótomos
Rugines-raspatoires
Periostotomi



67-687-10
10.0 mm

67-687-13
13.0 mm

67-687-19
19.0 mm

67-687-26
26.0 mm

67-687-32
32.0 mm

Cobb Periosteal Raspatory/Elevator
Overall Length 28 cm (11")



67-691-20
8.0 mm

67-693-20
10.0 mm

Langenbeck Periosteal Elevator
Overall Length 19.5 cm (7 3/4")



67-695-01
5.0 mm
17 cm (6 3/4")

67-695-02
7.0 mm
17 cm (6 3/4")

67-695-03
8.0 mm
17 cm (6 3/4")

67-695-04
5.0 mm
19.5 cm (7 3/4")

Martin-Langenbeck Periosteal Elevator

Periosteal Elevators
Raspatorien
Periostótomos
Rugines-raspatoires
Periostotomi



67-697-04
4.0 mm
16 cm (6 1/4")

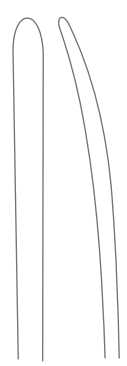

67-697-07
4.0 mm
17 cm (6 3/4")

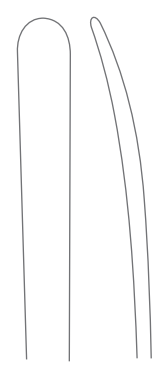

Williger Periosteal Elevator



67-699-16
Micro Elevator
Overall Length 16 cm (6 1/4")



67-701-16
Phalangeal Elevator
Overall Length 16 cm (6 1/4")



67-701-16
Phalangeal Elevator
Overall Length 16 cm (6 1/4")



Periosteal Elevators
Raspatorien
Periostótomos
Rugines-raspatoires
Periostotomi

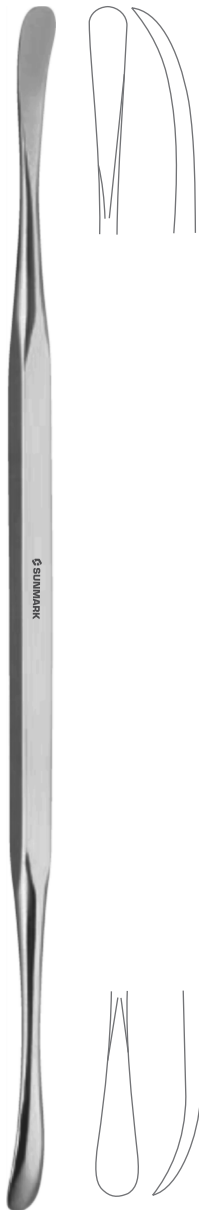

67-703-21
Alderdyce Periosteal Elevator
Double Ended
Overall Length 21 cm (8 ¼")



67-705-19
McDonald Periosteal Elevator
Double Ended
Overall Length 18.5 cm (7 ¼")



67-707-13 **67-707-19**
13 cm (5 ¼") 19 cm (7 ½")



67-709-18
18 cm (7")
67-709-20
20 cm (8")

Watson-Cheyne Periosteal Elevator
Double Ended

Swedish Periosteal Elevator
Double Ended

Periosteal Elevators, Bone Levers
 Raspatorien, Knochenhebel
 Periostótomos, Elevadores para hueso
 Rugines-raspatoires, Leviers à os
 Periostotomi, Elevatori per ossa



67-711-23
Pennybaker Periosteal Elevator
 Overall Length 23 cm (9")



67-713-22
O'Connell Periosteal Elevator
 Overall Length 22 cm (9")



67-715-24
Toennis Periosteal Elevator
 Overall Length 24 cm (9 1/2")



67-721-06
Bone Lever
 Overall Length 16 cm (6 1/4")

Bone Levers
Knochenhebel
Elevadores para hueso
Leviers à os
Elevatori per ossa



67-723-06
6.0 mm

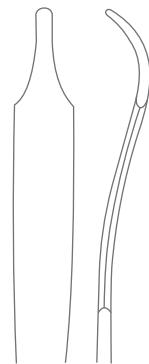

67-723-08
8.0 mm



67-725-15
Bone Lever
15.0 mm
Overall Length 16 cm (6 1/4")



67-727-16
Bone Lever
15.0 mm
Overall Length 12 cm (4 3/4")

Bone Levers
Knochenhebel
Elevadores para hueso
Leviers à os
Elevatori per ossa

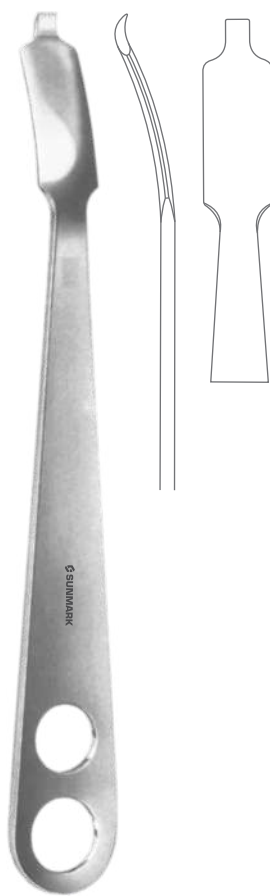

67-729-22
Wagner Bone Lever
Overall Length 22 cm (8 3/4")

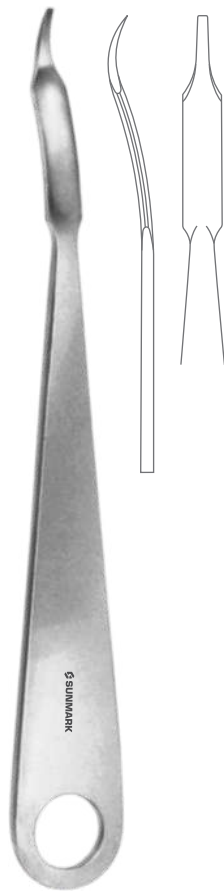

67-731-22
Bone Lever
Overall Length 22 cm (8 3/4")



67-733-08
Hohmann Bone Lever
Narrow Tip, 8.0 mm
Overall Length 22 cm (8 3/4")



67-733-18
Hohmann Bone Lever
Narrow Tip, 18.0 mm
Overall Length 23.5 cm (9 1/2")

Bone Levers
Knochenhebel
Elevadores para hueso
Leviers à os
Elevatori per ossa



67-733-43
Hohmann Bone Lever
Narrow Tip, 43.0 mm
Overall Length 23.5 cm (9 ½")



67-733-70
Hohmann Bone Lever
Narrow Tip, 70.0 mm
Overall Length 25 cm (9 ¾")



67-735-43
Hohmann Bone Lever
Narrow Tip, 43.0 mm
Overall Length 23.5 cm (9 ¼")



67-737-22
Hohmann Bone Lever
Wide Tip, 22.0 mm
Overall Length 25.5 cm (10")

Bone Levers
Knochenhebel
Elevadores para hueso
Leviers à os
Elevatori per ossa



67-737-35
Hohmann Bone Lever
Wide Tip, 35.0 mm
Overall Length 29 cm (11 1/2")



67-739-24
Hohmann Bone Lever
Wide Round Tip, 24.0 mm
Overall Length 27.5 cm (10 3/4")



67-741-22
Lange-Hohmann Bone Lever
Wide Tip With Groove, 22.0 mm
Overall Length 25.5 cm (9 3/4")

Bone Levers
Knochenhebel
Elevadores para hueso
Leviers à os
Elevatori per ossa



67-743-30
30.0 mm
26.5 cm (10 1/2")

67-057-15
33.0 mm
29 cm (11 1/2")

Lange-Hohmann Modif Bone Lever



67-745-44
44.0 mm
24 cm (9 1/2")

67-745-65
65.0 mm
25.5 cm (10")

Verbrugge-Mueller Bone Lever

Bone Levers
Knochenhebel
Elevadores para hueso
Leviers à os
Elevatori per ossa



67-749-40
Bone Lever
40.0 mm
Overall Length 29 cm (11 1/2")

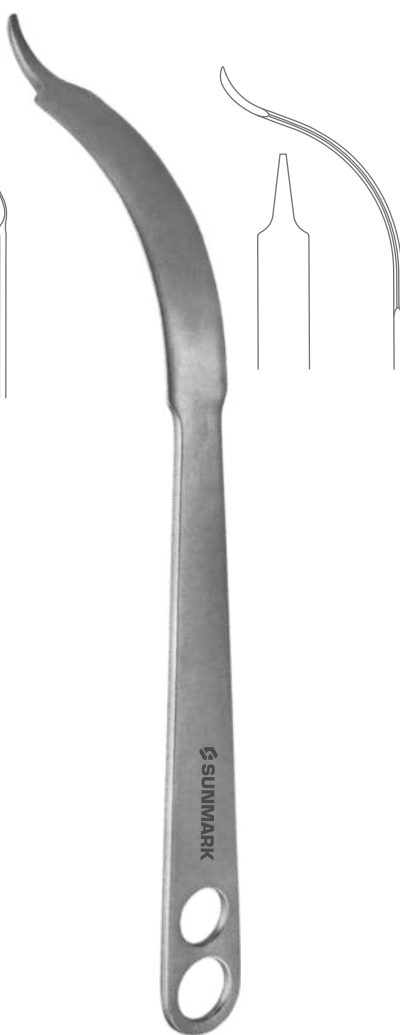

67-751-22
Bone Lever
22.0 mm
Overall Length 30 cm (12")



67-753-24
Hohmann-Aldinger Bone Lever
24.0 mm
Overall Length 27 cm (10 3/4")

Bone Levers
Knochenhebel
Elevadores para hueso
Leviers à os
Elevatori per ossa



67-755-37
Schumacher (Wagner) Bone Lever
Toothed Edge, 37 mm, 18 mm
Overall Length 34.5 cm (13 1/2")

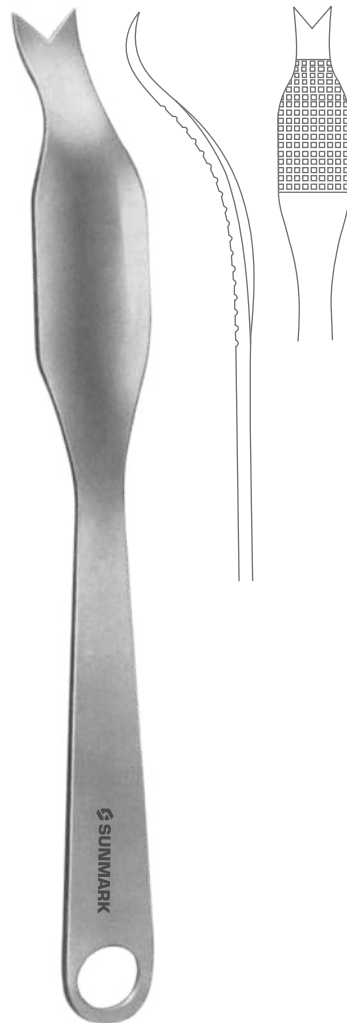

67-757-35
Schumacher Bone Lever
Toothed Edge, 35 mm, 18 mm
Overall Length 29 cm (11 1/2")



67-759-28
Watson-Jones Bone Lever
Overall Length 28 cm (11")



67-761-43
43 mm
24 cm (9 1/2")
67-761-60
60 mm
23.5 cm (9 1/4")

Bennett Bone Lever

Bone Levers
Knochenhebel
Elevadores para hueso
Leviers à os
Elevatori per ossa



67-763-30
Murphy-Lane Bone Lever
30.0 mm
Overall Length 32 cm (12 1/2")



67-765-21
Lane-Terthowan Bone Lever
Overall Length 21.5 cm (8 1/2")



67-765-25
Lane Bone Lever
Overall Length 25.5 cm (10")



67-765-23
Lane Bone Lever
Overall Length 23 cm (9")

Bone Levers, Knee Retractors
 Knochenhebel, Kniehaken
 Elevadores para hueso, Separadores para rodilla
 Leviers à os, Ecarteurs pour le genou
 Elevatori per ossa, Divaricatori per il ginocchio



Chandler Bone Lever



67-767-14
 14.0 mm
 18 cm (7")



67-767-19
 19.0 mm
 20 cm (8")

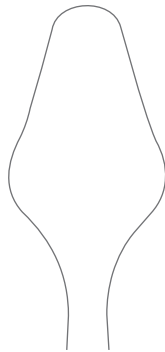

67-767-25
 25.0 mm
 23 cm (9")

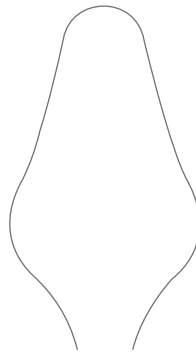

67-767-30
 30.0 mm
 25 cm (9 3/4")



Smillie Knee Retractor
 Overall Length 14 cm (5 1/2")

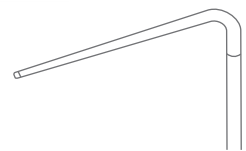

67-769-01
 32 x 19 mm

67-769-02
 48 x 19 mm

67-769-03
 57 x 19 mm

67-769-04
 52 x 13 mm

67-769-05
 12 x 13 mm

Knee Retractors
Kniehaken
Separadores para rodilla
Ecarteurs pour le genou
Divaricatori per il ginocchio



67-771-26
Blunt Knee Retractor
Blunt
Overall Length 26.5 cm (10 1/2")

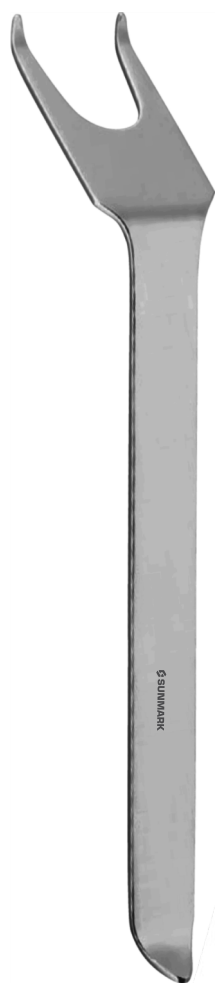

67-773-26
Blunt Knee Retractor
Overall Length 26.5 cm (10 1/2")



67-775-17
Blunt Knee Retractor
Overall Length 17.5 cm (7")



67-777-16
75 x 30 mm

67-779-16
100 x 30 mm

Taylor Knee Retractor
Overall Length 16 cm (6 1/4")

Knee Retractors, Meniscus Knives
 Kniehaken, Meniskotome
 Separadores para rodilla, Cuchillos para menisco
 Ecarteurs pour le genou, Bistouris à ménisque
 Divaricatori per il ginocchio, Meniscotomi



Hibbs Knee Retractor
 Overall Length 23.5 cm (9 1/4")

67-781-13
 13 x 25 mm

67-781-20
 20 x 50 mm

67-781-25
 25 x 75 mm



67-790-17
Smillie Meniscus Knife
 Straight
 Overall Length 17.5 cm (7")



67-791-17
Smillie Meniscus Knife
 Left
 Overall Length 17.5 cm (7")



67-793-17
Smillie Meniscus Knife
 Right
 Overall Length 17.5 cm (7")

Meniscus Knives
Meniskotome, Meniskusmesser
Cuchillos para menisco
Bistouris à ménisque
Meniscotomi



67-795-18
Meniscus Knife
Overall Length 18 cm (7")



67-797-22
Fig. 1

67-799-22
Fig. 2

Neff Meniscus Knife
Overall Length 22 cm (8 3/4")



67-801-22
Fig. 1

67-803-22
Fig. 2

Selenius Meniscus Knife
Overall Length 21 cm (8 1/4")



67-810-01
Fig. 1

67-810-02
Fig. 2

67-810-03
Fig. 3

67-810-04
Fig. 4

67-810-05
Fig. 5

Bunnell Tendon Stripper
Overall Length 15 cm (6")

Tendon Strippers
Sehnenstripper
Enucleadores de tendones
Instruments à écorcher les tendons
Scollatendini



67-812-40

4.0 mm

67-812-45

4.5 mm

67-812-55

5.5 mm

Tendon Stripper
Flexible Shaft
Overall Length 23 cm (9")



67-814-00

Tendon Passing Instruments

Overall Length 33.5 cm (13 1/4")



67-814-00

Screw Only For Tendon Passing Instruments

Overall Length 33.5 cm (13 1/4")



67-816-31

FiberGrip™ Fischer Tendon Stripper

Overall Length 28.5 cm (11 1/4")



Tendon Tunnelling Forceps
Sehndurchzugzangen
Pinzas para pasar tendones
Pincers pour passer les tendons
Pinze passa-tendini



67-818-29
Tendon Stripper
Overall Length 23 cm (9")



67-820-23
Bunnell Tendon Stripper
Malleable
Overall Length 16 cm (6 1/4")



67-824-16
Steinmann Tendon Holding Forcep
Overall Length 15 cm (6")



67-827-15
19 cm (7 1/2")

67-827-19
24 cm (9 3/4")

67-827-24
21 cm (8 1/4")

Brand Tendon Holding Forcep
1 x 2 Teeth

Tendon Tunnelling Forceps
Sehrendurchzugzangen
Pinzas para pasar tendones
Pinces pour passer les tendons
Pinze passa-tendini



67-828-21

Straight
1 x 2 Teeth

67-829-21

Curved
1 x 2 Teeth

Tendon Tunnelling Forcep
Overall Length 21 cm (8 ¼")



67-831-11
Carroll Tendon Tunnelling Forcep
Overall Length 11.5 cm (4 ½")



67-832-13
Tendon Tunnelling Forcep
Overall Length 11.5 cm (4 ½")



67-834-20
Kleine78-Kutz Tendon Holding Forcep
1 x 2 Teeth
Overall Length 21 cm (8 ¼")



67-836-15
15.5 cm (6")

Tendon Interlacing Forcep
Pointed

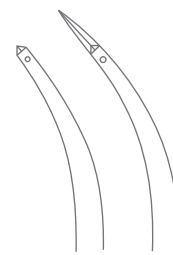

67-837-15
15 cm (6")

Reposition Forceps
Repositionszangen
Pinzas para reposición
Pincès à réduction
Pinze per riposizioni



67-851-09
9 cm (3 1/2")

67-851-14
15 cm (6")

Bone Repositioning Forcep
Long Ratchet, Pointed



67-853-13
Steinhauser Bone Repositioning Forcep
Overall Length 13 cm (5")



67-855-17
Reill Bone Repositioning Forcep
Overall Length 17 cm (6 3/4")



67-857-20
Bone Repositioning Forcep
Overall Length 20 cm (8")



67-859-12
Bone Repositioning Forcep
Long Ratchet, Pointed
Overall Length 13.5 cm (5 1/4")

Reposition Forceps, Bone Holding Forceps
Repositionszangen, Knochenhaltezangen
Pinzas para reposición, Pinzas para hueso
Pinces à réduction, Daviers porte-os
Pinze per riposizioni, Tenaglie per ossa



67-862-17
Lewin Bone Repositioning Forcep
Overall Length 18.5 cm (7 1/4")



67-864-14
Bone Repositioning Forcep
Overall Length 14 cm (5 1/2")



67-866-18
Bone Repositioning Forcep/Patella Forcep
Self Centering
Overall Length 18.5 cm (7 1/2")



67-868-21
**Bone Repositioning Forcep/
Malleolar Forcep**
Overall Length 21 cm (8 1/4")



67-869-14
Bone Holding Forcep
Overall Length 14 cm (5 1/2")

Reposition Forceps, Bone Holding Forceps
Repositionszangen, Knochenhalte­zangen
Pinzas para reposición, Pinzas para hueso
Pinces à réduction, Daviers porte-os
Pinze per riposizioni, Tenaglie per ossa



67-871-16
17 cm (6 ¾")
67-871-16
24 cm (9 ½")

Bone Repositioning Forcep
With Tread Fixation

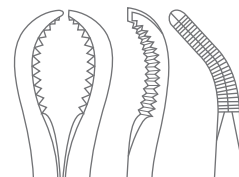

67-874-21
Langenbeck Bone Holding Forcep
Overall Length 21 cm (8 ¼")



67-876-21
Fergusson Bone Holding Forcep
Heavy Pattern
Overall Length 21 cm (8 ¼")

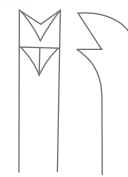

67-878-20
Fergusson Bone Holding Forcep
Heavy Pattern
Overall Length 20 cm (8")



Bone Holding Forcep / Sequestrum Forcep
Overall Length 20 cm (8")

67-880-20
Straight

67-881-20
Curved

Reposition Forceps, Bone Holding Forceps
 Repositionszangen, Knochenhalte-zangen
 Pinzas para reposición, Pinzas para hueso
 Pincès à réduction, Daviers porte-os
 Pinze per riposizioni, Tenaglie per ossa



67-882-01
 Straight
 20.5 cm (8")

67-882-02
 Curved Upwards
 20.5 cm (8")

67-882-03
 Sideways
 20 cm (8")

Bircher-Ganske Cartilage Seizing Forcep

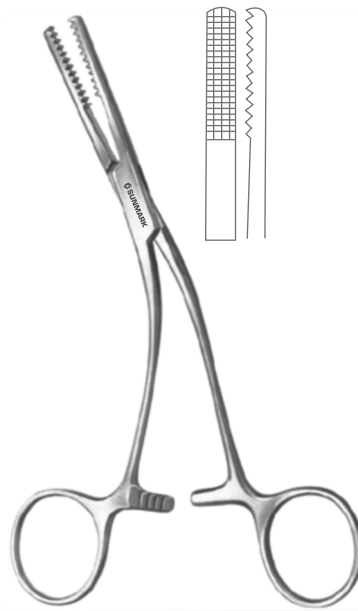

67-885-16
 Salyer Bone Holding Forcep
 Curved Sideways
 Overall Length 16 cm (6 1/4")



67-887-01
 Van Buren Bone Holding Forcep
 Overall Length 23 cm (9")



67-887-02
 Semb Bone Holding Forcep
 Overall Length 19 cm (7 1/2")



67-889-19
 Dingmann Cartilage Seizing Forcep
 Overall Length 18.5 cm (7 1/4")

Bone Holding Forceps
Knochenhaltezangen
Pinzas para hueso
Daviers porte-os
Tenaglie per ossa

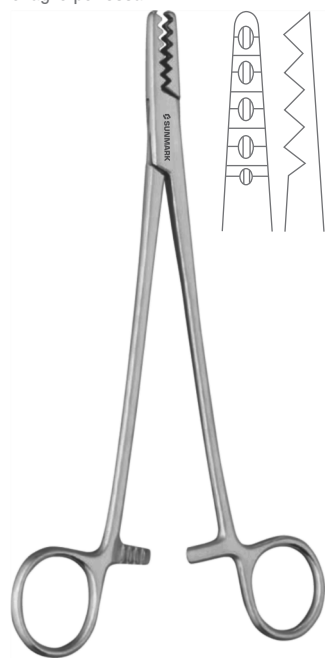

67-892-19
Martin Cartilage Seizing Forcep
Overall Length 18.5 cm (7 1/4")



67-894-19
Frosch Bone Holding Forcep
Overall Length 18 cm (7")



67-896-17
17 cm (6 3/4")
67-896-21
21 cm (8 1/4")



67-899-21
21 cm (8 1/4")
67-899-27
27 cm (10 3/4")
67-899-30
30 cm (12")

Heygroves Bone Holding Forcep
With Thread Fixations



67-901-19
Semb Bone Holding Forcep
Curved Sideways, With Ratchet
Overall Length 19 cm (7 1/2")

Bone Holding Forceps
Knochenhaltezangen
Pinzas para hueso
Daviers porte-os
Tenaglie per ossa



Farabeuf Bone Holding Forcep

67-904-23
23 cm (9")

67-904-26
26 cm (10 1/4")



67-906-26
Farabeuf Bone Holding Forcep
With Ratchet
Overall Length 26 cm (10 1/4")

67-908-22
Lambotte Bone Holding Forcep
Straight
Overall Length 22 cm (8 3/4")

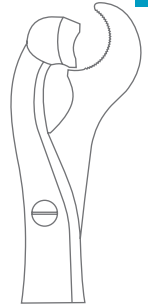

Lambotte Bone Holding Forcep
Straight, One Jaw Moveable

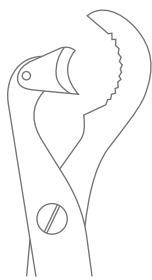

67-908-26
26 cm (10 1/4")

67-908-33
33 cm (13")



Ulrich Bone Holding Forcep
Straight, With Thread Fixation

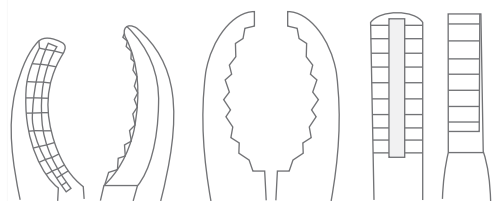

67-910-23
23 cm (9")

67-910-25
25 cm (9 3/4")

67-910-28
28 cm (11")

Bone Holding Forceps
Knochenhaltezangen
Pinzas para hueso
Daviers porte-os
Tenaglie per ossa



Ulrich Bone Holding Forcep
Straight, With Thread Fixation

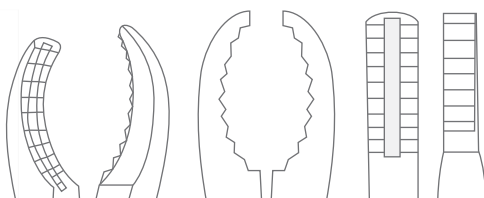

67-911-23
22 cm (8 3/4")

67-911-25
24 cm (9 1/2")

67-910-28
27 cm (10 3/4")

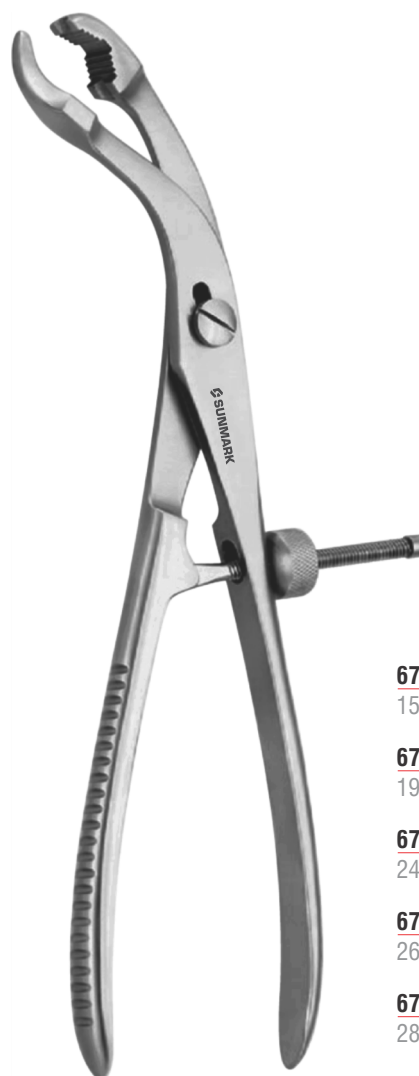

Bone Holding Forcep
Self Centering, With Thread Fixation

67-913-15
15 cm (6")

67-913-19
19 cm (7 1/2")

67-913-24
24 cm (9 1/2")

67-913-26
26 cm (10 1/4")

67-913-28
28 cm (11")

Bone Holding Forceps
Knochenhaltezangen
Pinzas para hueso
Daviers porte-os
Tenaglie per ossa

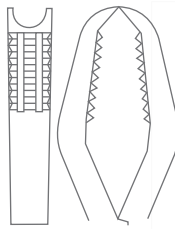

67-916-33
Lane Bone Holding Forcep
Without Ratchet
Overall Length 33 cm (13")

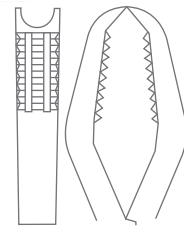

67-918-33
Lane Bone Holding Forcep
With Ratchet
Overall Length 33 cm (13")

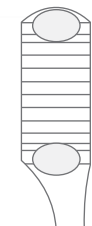

67-921-01
25 cm (9 3/4")
67-921-02
26 cm (10 1/4")
67-921-03
27 cm (10 3/4")

Verbrugge Bone Holding Forcep

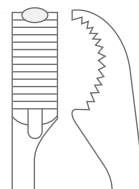

67-923-01
Verbrugge Bone Holding Forcep
Overall Length 17.5 cm (7")



67-925-00
Percy Amputation Shield
Detachable

Bone Rongeurs
Hohlmeißelzangen
Pinzas gubias
Pincès-gouges
Pinze-sgorbie



67-931-01
17.5 cm (7")

67-931-02
16.5 cm (6 1/2")

Stellbrink Bone Rongeur



67-932-12
Friedman Bone Rongeur
Overall Length 12.5 cm (5")



67-933-01
Friedman Bone Rongeur
Overall Length 13.5 cm (5 1/4")



67-934-02
Friedman Bone Rongeur
Overall Length 13.5 cm (5 1/4")



Cleveland Bone Rongeur

67-935-01
13.5 cm (5 1/4")

67-935-02
16.5 cm (6 1/2")

Bone Rongeurs
Hohlmeißelzangen
Pinzas gubias
Pinces-gouges
Pinze-sgorbie



67-937-16
Mead Bone Rongeur
Overall Length 16.5 cm (6 1/2")



67-937-18
Hartmann Bone Rongeur
Overall Length 17.5 cm (7")



Jansen Bone Rongeur



67-938-18
Straight
18 cm (7")



67-939-18
Curved
18 cm (7")

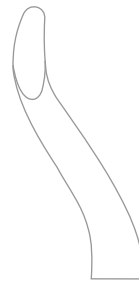

67-939-19
Angled
19 cm (7 1/2")

Bone Rongeurs
 Hohlmeißelzangen
 Pinzas gubias
 Pinces-gouges
 Pinze-sgorbie



67-940-19
Lempert Bone Rongeur
 Overall Length 19 cm (7 1/2")



Blumenthal Bone Rongeur

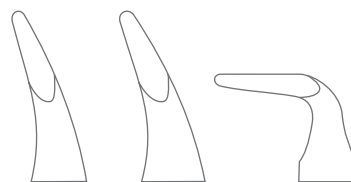

67-941-01 15 cm (6")
67-941-02 15 cm (6")
67-941-03 14 cm (5 1/2")



Luer Bone Rongeur



67-942-18 Straight 18.5 cm (7 1/4")
67-943-18 Curved 18 cm (7")



Luer Bone Rongeur
 Overall Length 14.5 cm (5 3/4")

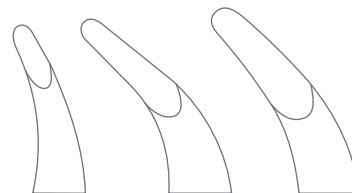

67-945-01 **67-945-02** **67-945-03**

Bone Rongeurs
Hohlmeißelzangen
Pinzas gubias
Pincès-gouges
Pinze-sgorbie

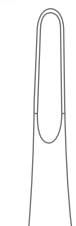
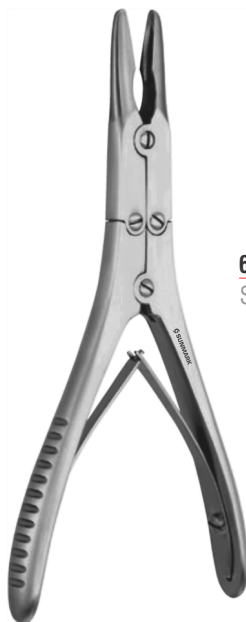

67-946-15
Straight



67-947-15
Curved

Bohler Bone Rongeur
Compound Action
Overall Length 15.5 cm (6")

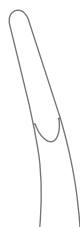

67-949-18
Beyer Bone Rongeur
Compound Action
Overall Length 18 cm (7")



67-951-18
Zaufal-Jansen Bone Rongeur
Compound Action
Overall Length 18 cm (7")

Bone Rongeurs
Hohlmeißelzangen
Pinzas gubias
Pinces-gouges
Pinze-sgorbie



67-953-17
Mayfield Bone Rongeur
Compound Action
Overall Length 18 cm (7")



67-953-20
Marquard Bone Rongeur
Compound Action
Overall Length 20.5 cm (8")



67-955-18
Ruskin Bone Rongeur
Compound Action
Overall Length 19 cm (7 1/2")



67-955-24
Ruskin Bone Rongeur
Compound Action
Overall Length 24 cm (9 1/2")

Bone Rongeurs
Hohlmeißelzangen
Pinzas gubias
Pincis-gouges
Pinze-sgorbie



67-957-22
Semb Bone Rongeur
Compound Action
Overall Length 23.5 cm (9 1/4")



67-959-23
Stille-Ruskin Bone Rongeur
Compound Action
Overall Length 23.5 cm (9 1/4")



67-959-24
Roettgen-Ruskin Bone Rongeur
Compound Action
Overall Length 24.5 cm (9 3/4")



67-961-01



67-961-02

67-963-24
Frykholm Bone Rongeur
Compound Action
Overall Length 24.5 cm (9 3/4")



67-964-22
Straight

67-965-22
Curved

Leksell-Stille Bone Rongeur
Compound Action
Overall Length 24.5 cm (9 3/4")

Stille-Luer Bone Rongeur
Compound Action
Overall Length 22.5 cm (8 3/4")

Bone Rongeurs
Hohlmeißelzangen
Pinzas gubias
Pinces-gouges
Pinze-sgorbie



67-966-23
Straight
23 cm (9")

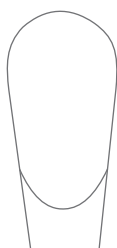

67-966-27
Straight
26.5 cm (10 1/2")



67-967-23
Curved
23 cm (9")



67-967-27
Curved
26.5 cm (10 1/2")

Stille-Luer Bone Rongeur
Compound Action

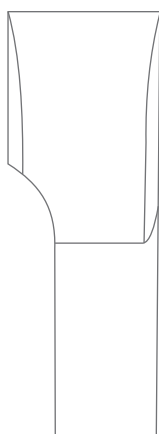

67-968-01

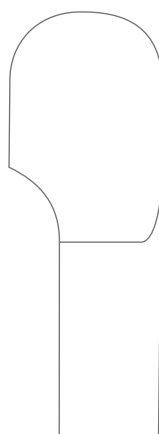

67-968-02

Sauerbruch Bone Rongeur
Compound Action
Overall Length 31 cm (12 1/4")



Bone Cutting Forceps
 Knochensplitterzangen
 Pinzas cortantes para hueso
 Pincès coupantes à os
 Cesoie per ossa



67-970-19
Cottle-Kazanjian Bone Cutting Forcep
 Overall Length 18.5 cm (7 1/4")



Liston Bone Cutting Forcep



67-972-14
 Straight
 14 cm (5 1/2")



67-972-17
 Straight
 17 cm (6 3/4")



67-972-19
 Straight
 20 cm (8")



67-972-22
 Straight
 22 cm (8 3/4")



67-973-14
 Straight
 14 cm (5 1/2")



67-973-17
 Straight
 17 cm (6 3/4")

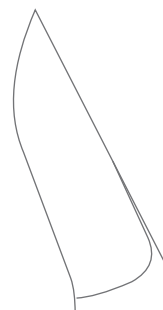

67-973-19
 Straight
 20 cm (8")

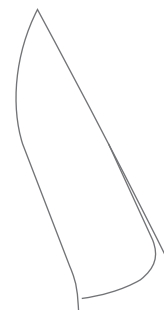

67-973-22
 Straight
 22 cm (8 3/4")

Bone Cutting Forceps
Knochensplitterzangen
Pinzas cortantes para hueso
Pinces coupantes à os
Cesoie per ossa



Cleveland Bone Cutting Forcep



67-975-15
14.5 cm (5 3/4")



67-975-17
17 cm (6 3/4")



67-976-15
Bohler Bone Cutting Forcep
Compound Action, Light
Overall Length 14.5 cm (5 3/4")

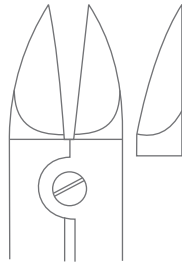

67-977-15
Bohler Bone Cutting Forcep
Compound Action, Heavy
Overall Length 14.5 cm (5 3/4")

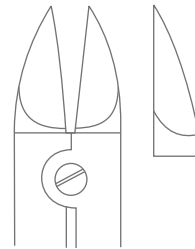

Bone Cutting Forceps
Knochensplitterzangen
Pinzas cortantes para hueso
Pinces coupantes à os
Cesoie per ossa



67-979-15
Cleveland Bone Cutting Forcep
Overall Length 16 cm (6 1/4")



67-980-18
Straight



67-981-18
Curved

Ruskin-Liston Bone Cutting Forcep
Compound Action
Overall Length 18 cm (7")

Bone Cutting Forceps
Knochensplitterzangen
Pinzas cortantes para hueso
Pinces coupantes à os
Cesoie per ossa



Stille-Liston Bone Cutting Forcep
Compound Action



67-982-01
Straight
27.5 cm (10 3/4")



67-982-02
Curved
23.5 cm (9 1/4")

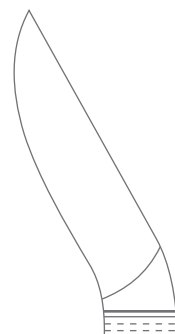

67-982-03
Curved
27.5 cm (10 3/4")

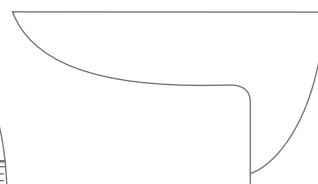

67-982-04
26.5 cm (10 1/4")

Bone Cutting Forceps
Knochensplitterzangen
Pinzas cortantes para hueso
Pinces coupantes à os
Cesoie per ossa



67-985-27
Liston-Key Bone Cutting Forcep
Compound Action
Overall Length 25.5 cm (10")



67-987-25
Semb Bone Cutting Forcep
Compound Action
Overall Length 24.5 cm (9 3/4")

Hand Restrainer, Tourniquet
 Handhalter, Kompressorium
 Sujetador de mano, Compresor
 Reteneur pour main, Compresseur
 Fissatore per mano, compressorio



Hand Immobilizer
Aluminium

67-988-01
For Children

67-988-02
For Adults



67-990-10
Feldheim Tourniquet
Overall Length 10 cm (4")



67-992-00
Ideal Finger Nail Drill Complete
With Drill Ref: 67-992-01 to 67-992-03



Spare Drill

67-992-01
Small

67-992-02
Medium

67-992-03
Large



Finger Ring Saws, Finger Nail Drill
 Fingerringsägen, Fingernagelbohrer
 Sierras para abrir anillos, Dedo clavo perforación
 Scies pour couper les bagues, Foret d'ongle de doigt
 Seghe per anelli, Dito trivello del chiodo



67-994-17
Martin Finger Ring Saw
 Overall Length 18.5 cm (7 1/4")



67-994-00
Spare Saw Blade



67-995-16
Martin Finger Ring Saw
 Overall Length 18.5 cm (7 1/4")



67-995-01
Spare Saw Blade

Nail Extracting Forceps
 Nageextraktionszangen
 Pinzas para arrancar uñas
 Pincès pour extraire les ongles
 Pinze per la lacerazione delle unghie



67-996-17
Finger Ring Saw
 Overall Length 17 cm (6 3/4")



67-996-10
Spare Saw Blade



67-998-12
Anvil Nail Extracting Forcep
 Overall Length 12.5 cm (5")



67-999-13
Radolf Nail Extracting Forcep
 Overall Length 14 cm (5 1/2")

Milium Knife, Lupus Instruments
 Milienmesser, Lupusinstrumente
 Chuchillo para milium, Instrumentos para lupus
 Couteau pour milium, Instruments pour les lupus
 Bisturi per milie, Strumenti per lupus



36-100-14
Monocorps Milium Knife
 Overall Length 14 cm (5 ½")



36-111-14
Vidal Lupus Scraper
 Overall Length 13 cm (5")

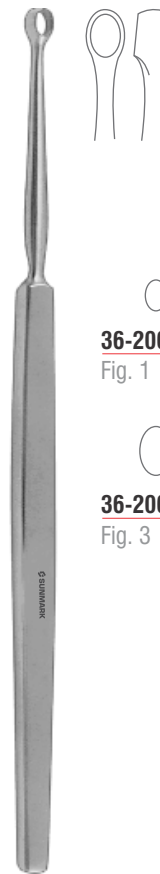

36-200-01
 Fig. 1

36-200-02
 Fig. 2

36-200-03
 Fig. 3

36-200-04
 Fig. 4

Fox Lupus Curette
 Overall Length 14 cm (5 ½")

Lupus Instruments
Lupusinstrumente
Instrumentos para lupus
Instruments pour les lupus
Strumenti per lupus



Wolf Lupus Curette
Overall Length 14 cm (5 1/2")

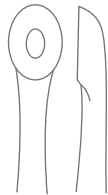

36-220-01
Fig. 1



36-220-02
Fig. 2



36-220-03
Fig. 3



36-220-04
Fig. 4



36-220-05
Fig. 5



36-220-06
Fig. 6



Kaye Face-Lift Hook
Overall Length 13 cm (5")



36-225-04
4 Prongs



36-225-05
5 Prongs

Dermal Punches
 Hauttrephine
 Trépanos para piel
 Trépanos cutanés
 Trefine cutanee



36-300-00
 Handle Only
 8 cm (3 1/4")

36-300-02
 Ø 2.0 mm

36-300-04
 Ø 4.0 mm

36-300-06
 Ø 6.0 mm

36-300-08
 Ø 8.0 mm

36-300-10
 Ø 10.0 mm

36-300-12
 Ø 12.0 mm

Dermal Punch
 Sharp
 Overall Length 5.5 cm (2 1/4")



36-320-02
 Ø 12.0 mm

36-320-03
 Ø 12.0 mm

36-320-04
 Ø 12.0 mm

36-320-05
 Ø 12.0 mm

36-320-06
 Ø 12.0 mm

36-320-07
 Ø 12.0 mm

36-320-08
 Ø 12.0 mm

Keyes Dermal Punch
 Sharp
 Overall Length 11 cm (4 1/2")

Comedone Extractors
Komedoneninstrumente
Extractores para comedones
Tire-comédons
Tiracomedoni



36-351-14
Unna Comedone Extractor
Overall Length 14.5 cm (5 3/4")



36-353-14
Unna Comedone Extractor
Overall Length 14.5 cm (5 3/4")



36-361-10
Saalfeld Comedone Extractor
Overall Length 11 cm (4 1/2")

Comedone Extractors
Komedoneninstrumente
Extractores para comedones
Tire-comédons
Tiracomedoni

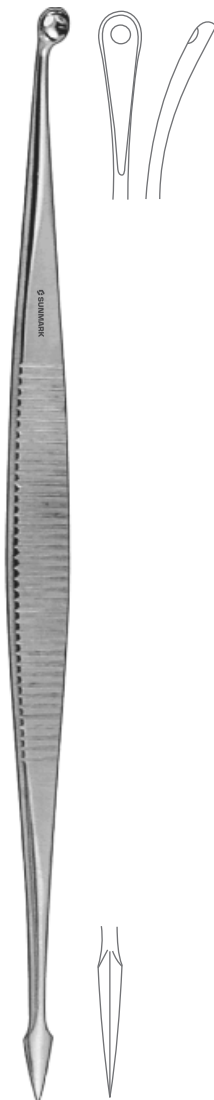

36-365-14
Saalfeld Comedone Extractor
Overall Length 14.5 cm (5 3/4")



36-371-10
Schamberg Comedone Extractor
Overall Length 9.5 cm (3 3/4")



36-381-14
Katsch Comedone Extractor
Overall Length 16 cm (6 1/4")

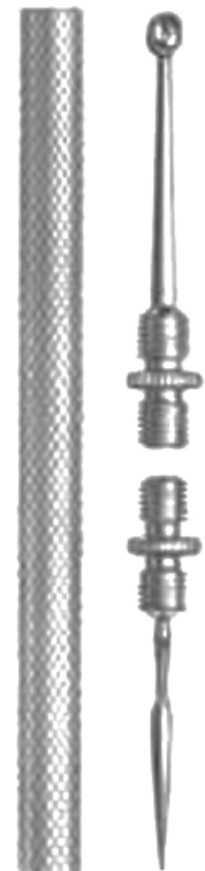

36-390-11
Unna-Vidal Comedone Extractor
Overall Length 11.5 cm (4 1/2")

Intestinal and Tissue Grasping Forceps
 Darm- und Gewebefasszangen
 Pinzas para intestinos y tejidos
 Pinces pour saisir intestins et tissus
 Pinze per afferrare intestino e tessuti



74-010-12
Allis-Baby Tissue Grasping Forcep
 4 x 5 Teeth
 Overall Length 13 cm (5")



74-012-15
Allis Tissue Grasping Forcep
 4 x 5 Teeth
 Overall Length 15.5 cm (6")



Intestinal and Tissue Grasping Forceps
 Darm- und Gewebefasszangen
 Pinzas para intestinos y tejidos
 Pincés pour saisir intestins et tissus
 Pinze per afferrare intestino e tessuti



Allis Tissue Grasping Forcep
 5 x 6 Teeth

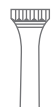

74-015-15
 15.5 cm (6")



74-015-19
 19 cm (7 1/2")



74-015-25
 25.5 cm (10")



5:6



Allis Atrauma Tissue Grasping Forcep



74-020-16
 15.5 cm (6")



74-020-20
 20 cm (8")



74-020-25
 24.5 cm (9 3/4")



74-020-30
 30 cm (11 3/4")

STOMACH, INTESTINES, RECTUM



Intestinal and Tissue Grasping Forceps
 Darm- und Gewebefasszangen
 Pinzas para intestinos y tejidos
 Pinces pour saisir intestins et tissus
 Pinze per afferrare intestino e tessuti



74-024-15
Allis-Adair Tissue Grasping Forcep
 10 x 11 Teeth
 Overall Length 16 cm (6 1/4")



10:11



74-026-15
Boys-Allis Tissue Grasping Forcep
 5 x 6 Teeth
 Overall Length 15.5 cm (6")



5:6

Intestinal and Tissue Grasping Forceps
 Darm- und Gewebefasszangen
 Pinzas para intestinos y tejidos
 Pinces pour saisir intestins et tissus
 Pinze per afferrare intestino e tessuti

74

STOMACH, INTESTINES, RECTUM



74-028-15
15.5 cm (6")

74-028-19
19 cm (7 1/2")

Judd-Allis Tissue Grasping Forcep
3 x 4 Teeth



3:4



74-030-20
Thomas-Allis Tissue Grasping Forcep
6 x 7 Teeth
Overall Length 20.5 cm (8")



6:7

Intestinal and Tissue Grasping Forceps
 Darm- und Gewebefasszangen
 Pinzas para intestinos y tejidos
 Pincés pour saisir intestins et tissus
 Pinze per afferrare intestino e tessuti



74-032-20
Allis Tissue Grasping Forcep
 5 x 6 Teeth
 Overall Length 20 cm (8")



5:6

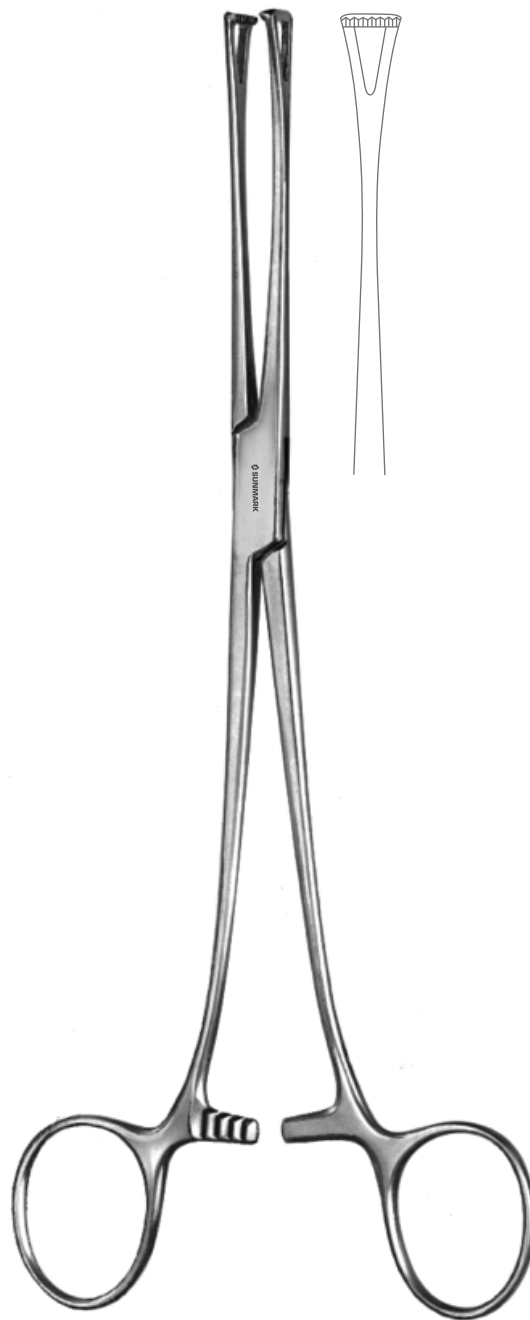

74-040-20
Lockwood Tissue Grasping Forcep
 Overall Length 20 cm (8")

Intestinal and Tissue Grasping Forceps
 Darm- und Gewebefasszangen
 Pinzas para intestinos y tejidos
 Pinces pour saisir intestins et tissus
 Pinze per afferrare intestino e tessuti



74-042-18
Littlewood Tissue Grasping Forcep
 Overall Length 18.5 cm (7 1/4")



74-050-16
Williams Tissue Grasping Forcep
 Overall Length 16.5 cm (6 1/2")

Intestinal and Tissue Grasping Forceps
Darm- und Gewebefasszangen
Pinzas para intestinos y tejidos
Pinces pour saisir intestins et tissus
Pinze per afferrare intestino e tessuti



74-056-16
16.5 cm (6 1/2")

74-056-20
21 cm (8 1/4")

UltraGrip™ TC Babcock Tissue Grasping Forcep

ULTRA GRIP X



74-060-16
15.5 cm (6")

74-060-18
17.5 cm (7")

74-060-20
21 cm (8 1/4")

74-060-24
24 cm (9 1/2")

Babcock Tissue Grasping Forcep

Intestinal and Tissue Grasping Forceps
 Darm- und Gewebefasszangen
 Pinzas para intestinos y tejidos
 Pinces pour saisir intestins et tissus
 Pinze per afferrare intestino e tessuti



74-062-16
16 cm (6 1/4")

74-062-20
20.5 cm (8")

Babcock Atrauma Tissue Grasping Forcep

Atrauma™



74-070-20
UltraGrip™ TC Duval Tissue Grasping Forcep
Overall Length 20.5 cm (8")

ULTRA GRIP™

Intestinal and Tissue Grasping Forceps
 Darm- und Gewebefasszangen
 Pinzas para intestinos y tejidos
 Pinces pour saisir intestins et tissus
 Pinze per afferrare intestino e tessuti



Duval Tissue Grasping Forcep

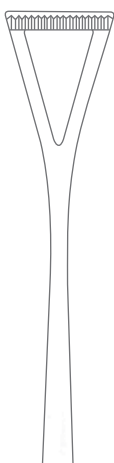

74-072-18
Narrow Jaw
18 cm (7")

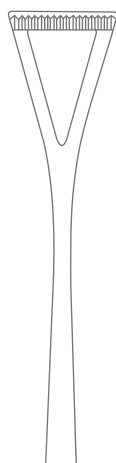

74-072-20
Narrow Jaw
20.5 cm (8")

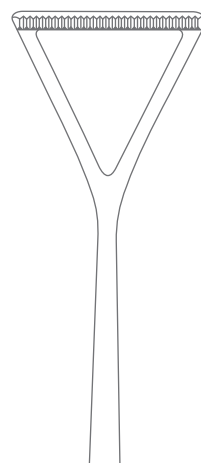

74-074-20
Wide Jaw
20.5 cm (8")

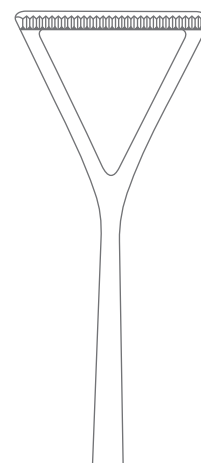

74-074-23
Wide Jaw
23 cm (9")

Intestinal Clamps
Darmklemmen
Pinzas intestinales
Pincas intestinales
Pinze intestinali

STOMACH, INTESTINES, RECTUM



74-080-22
Gregoire Rhomboid Grasping Forcep
Overall Length 22 cm (8 ½")



74-100-18
Straight
18 cm (7")

74-101-18
Curved
17.5 cm (7")

Doyen-Baby Intestinal Clamp

Intestinal Clamps
Darmklemmen
Pinzas intestinales
Pinces intestinales
Pinze intestinali



Doyen Intestinal Clamp



74-102-23
Straight

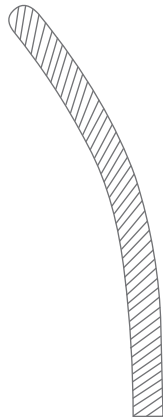

74-103-23
Curved



Mayo-Robson Intestinal Clamp



74-110-21
Straight
21.5 cm (8 1/2")

74-110-23
Straight
23.5 cm (9 1/4")

74-110-25
Straight
25.5 cm (10")



74-111-21
Curved
21.5 cm (8 1/2")

74-111-23
Curved
23 cm (9")

74-111-25
Curved
24.5 cm (9 3/4")

Intestinal Clamps
Darmklemmen
Pinzas intestinales
Pincers intestinales
Pinze intestinali

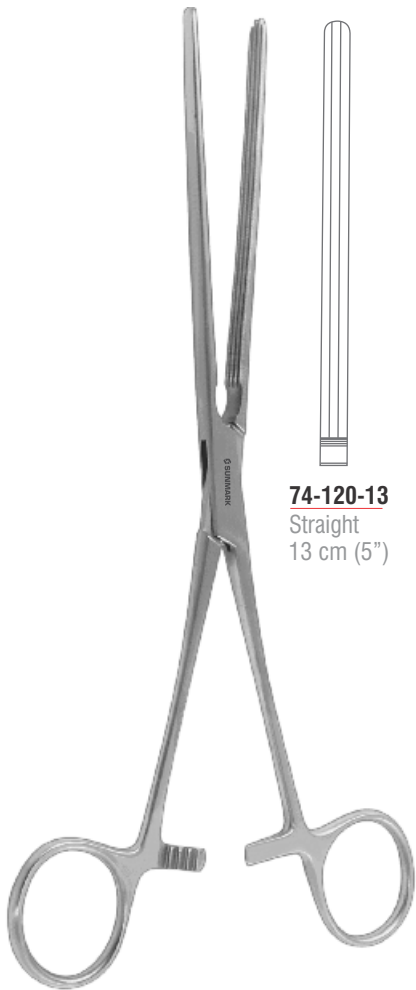

74-120-13
Straight
13 cm (5")



74-121-13
Curved
13 cm (5")

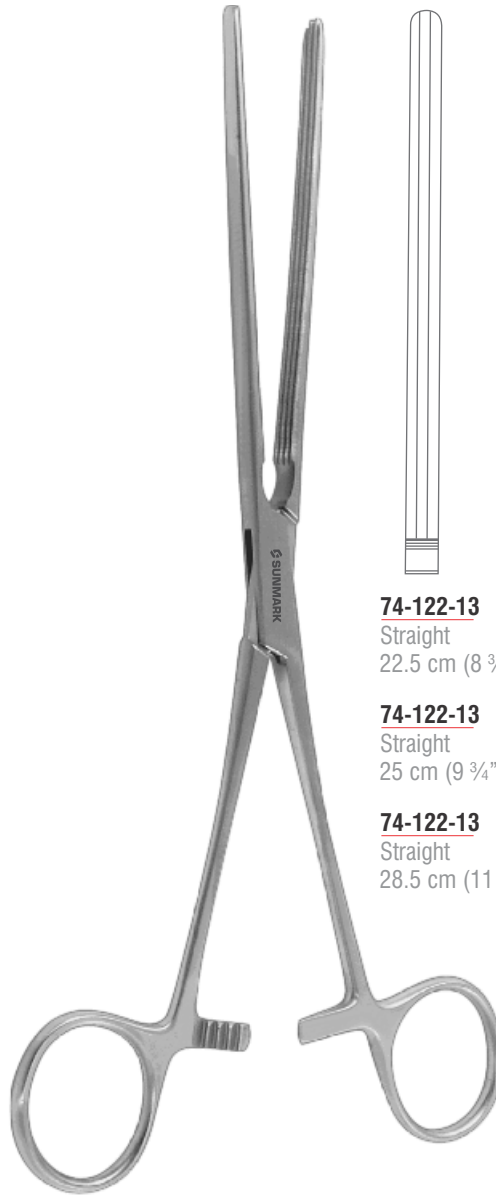

74-122-13
Straight
22.5 cm (8 ¾")

74-122-13
Straight
25 cm (9 ¾")

74-122-13
Straight
28.5 cm (11 ¼")



74-123-13
Curved
22.5 cm (8 ¾")

74-123-13
Curved
24.5 cm (9 ¾")

74-123-13
Curved
27.5 cm (10 ¾")

Kocher-Baby Intestinal Clamp

Kocher Intestinal Clamp



Intestinal Clamps
Darmklemmen
Pinzas intestinales
Pincas intestinales
Pinze intestinali



74-128-16
Allen Intestinal Clamp
Overall Length 16 cm (6 1/4")

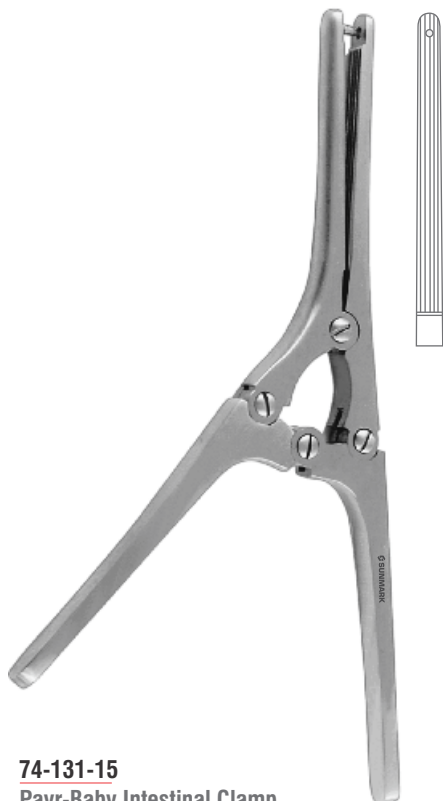

74-131-15
Payr-Baby Intestinal Clamp
Overall Length 15 cm (6")



74-133-21
20.5 cm (8")

74-133-29
29 cm (11 1/2")

74-133-35
34.5 cm (13 1/2")

Intestinal Clamps
Darmklemmen
Pinzas intestinales
Pinces intestinales
Pinze intestinali



Nussbaum Intestinal Clamp
Overall Length 25 cm (9 3/4")

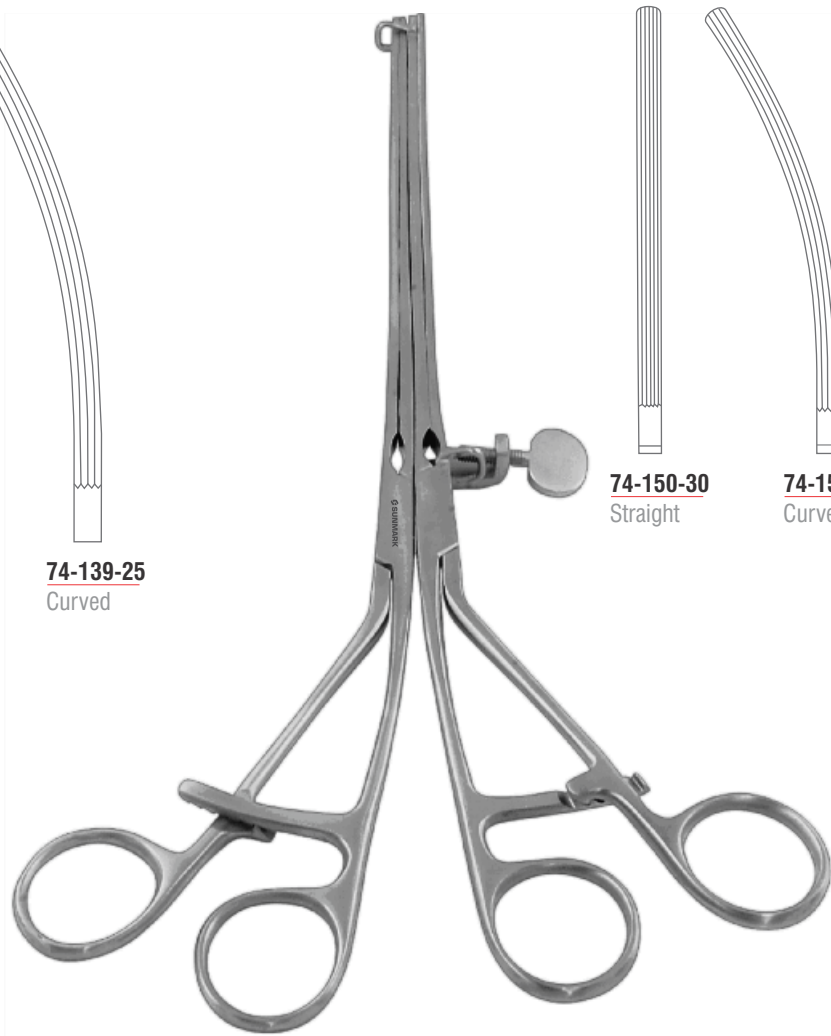

Lane Intestinal Clamp
Overall Length 30 cm (11 3/4")

Intestinal Clamps
Darmklemmen
Pinzas intestinales
Pinces intestinales
Pinze intestinali

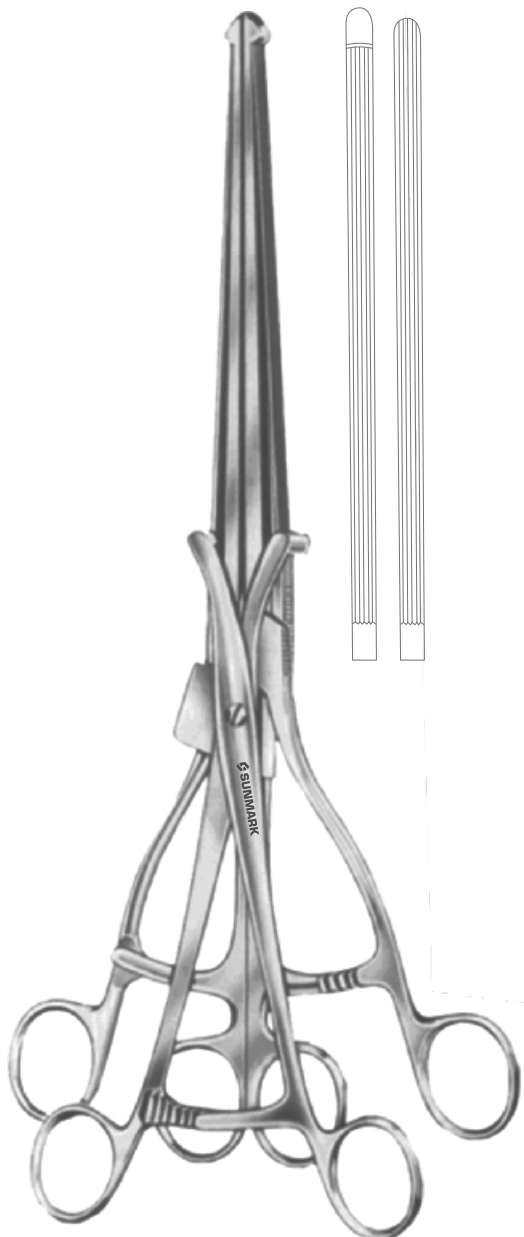

74-156-36
Haberer Intestinal Clamp
Overall Length 36 cm (14 1/4")

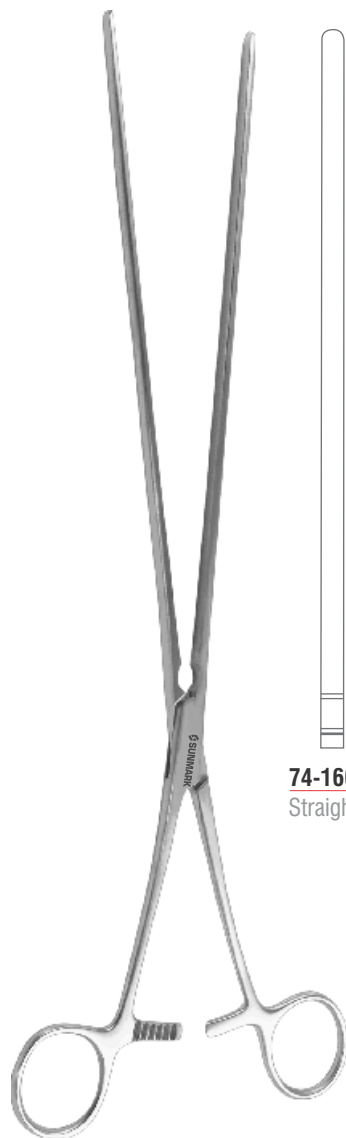

Scudder Intestinal Clamp

74-160-33
Straight

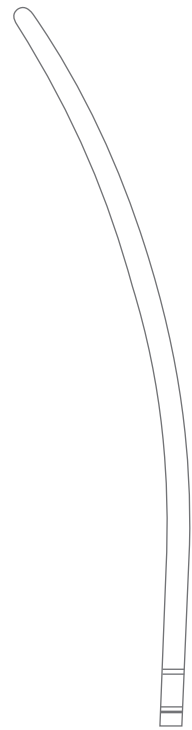

74-161-33
Curved

Intestinal Clamps
Darmklemmen
Pinzas intestinales
Pinces intestinales
Pinze intestinali

74

STOMACH, INTESTINES, RECTUM

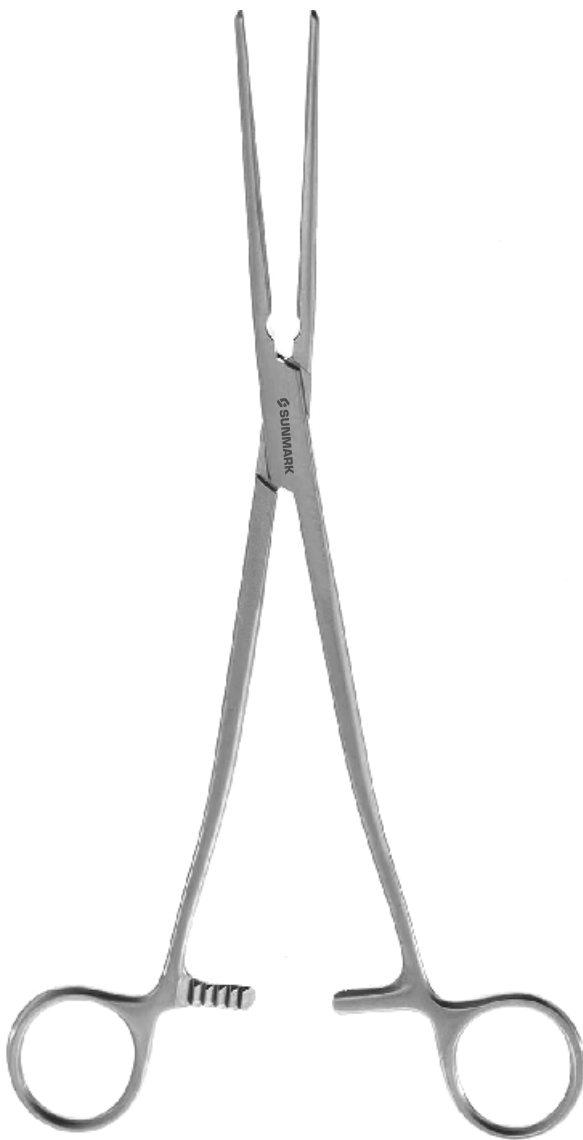

74-162-23
Dennis Anastomosis Clamp
Straight, Longitudinal Serrations
Overall Length 23 cm (9")

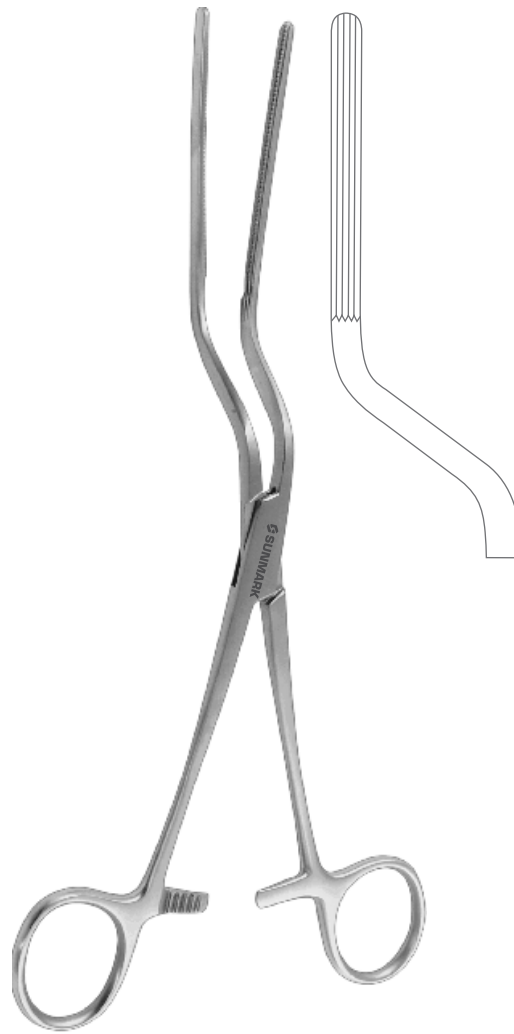

74-165-24
Brunner Sigmoid Anastomosis Clamp
Overall Length 24 cm (9 1/2")



Intestinal Clamps
 Darmklemmen
 Pinzas intestinales
 Pincas intestinales
 Pinze intestinali



74-167-31
Lloyd-Davis Rectal Occlusion Forcep
 Overall Length 31.5 cm (12 1/2")

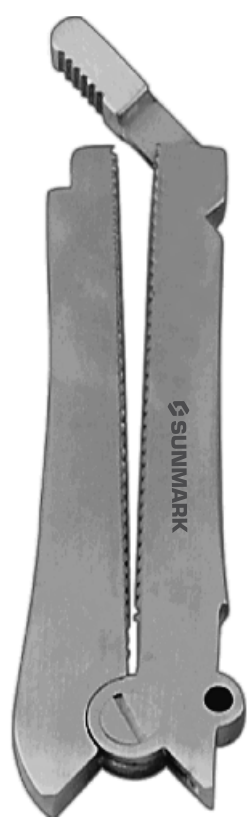

74-170-00
De Martel-Wolfson Intestinal Anastomosis Clamp
 Set of 3 Ref: 74-172-01 to 74-172-03

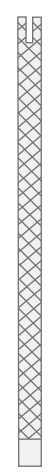

- 74-172-01**
65 mm
- 74-172-02**
80 mm
- 74-172-03**
110 mm

Intestinal Clamps
Darmklemmen
Pinzas intestinales
Pincas intestinales
Pinze intestinali



74-179-25
De Martel-Wolfson Closing Forcep
Overall Length 25 cm (9 3/4")



74-180-09
9.5 cm (3 3/4")
74-180-23
23 cm (9")

De Martel-Wolfson Closing Forcep



74-186-15
Benson Pylorus Spreader
Overall Length 15.5 cm (6")

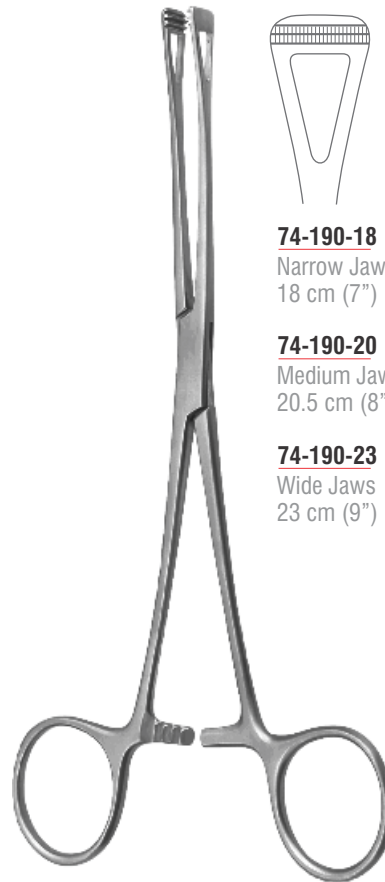

74-190-18
Narrow Jaws
18 cm (7")

74-190-20
Medium Jaws
20.5 cm (8")

74-190-23
Wide Jaws
23 cm (9")

Scheibe (Collin) Atrauma Organ Grasping





Intestinal Clamps
Darmklemmen
Pinzas intestinales
Pinces intestinales
Pinze intestinali

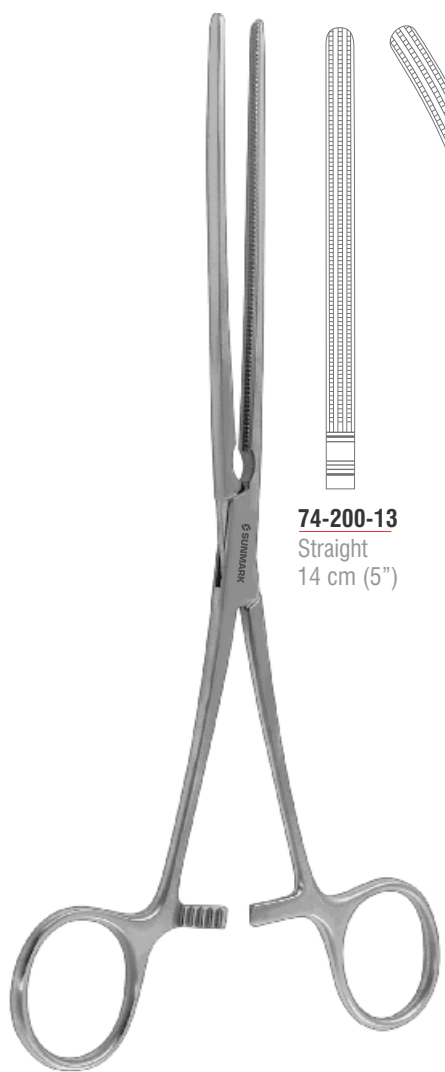

Doyen-Baby Atrauma Intestinal Clamp



74-200-13
Straight
14 cm (5")

74-201-13
Curved
13.5 cm (4 3/4")

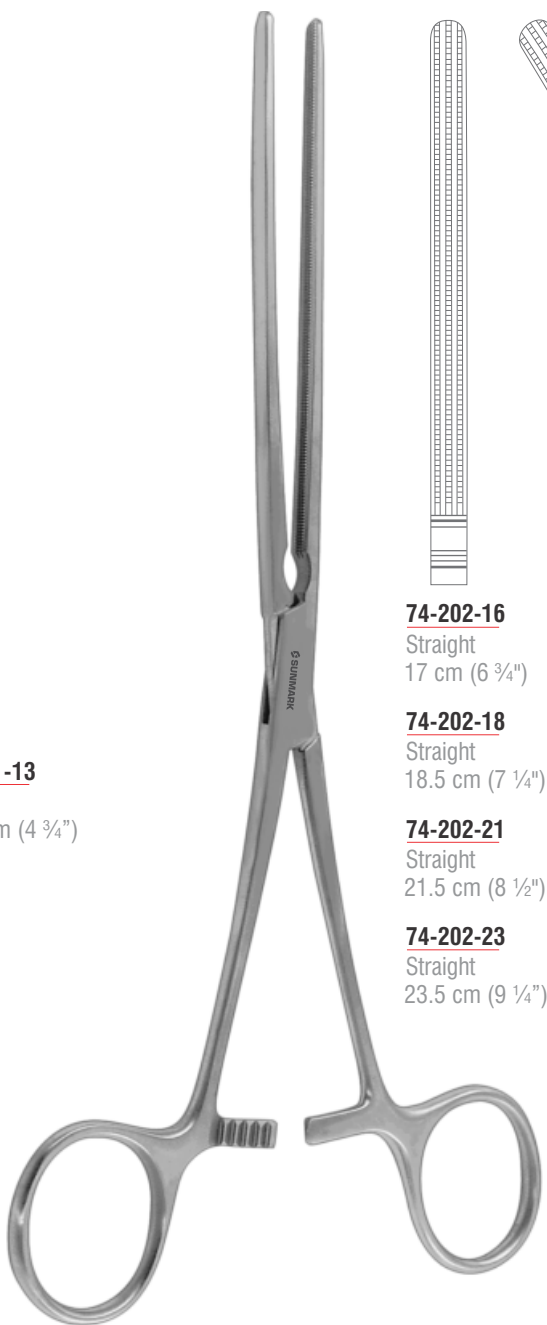

Doyen Atrauma Intestinal Clamp



74-202-16
Straight
17 cm (6 3/4")

74-202-18
Straight
18.5 cm (7 1/4")

74-202-21
Straight
21.5 cm (8 1/2")

74-202-23
Straight
23.5 cm (9 1/4")

74-203-16
Curved
17 cm (6 3/4")

74-203-18
Curved
18 cm (7")

74-203-21
Curved
21 cm (8 1/4")

74-203-23
Curved
23 cm (9")

Intestinal Clamps
Darmklemmen
Pinzas intestinales
Pincas intestinales
Pinze intestinali

74

STOMACH, INTESTINES, RECTUM

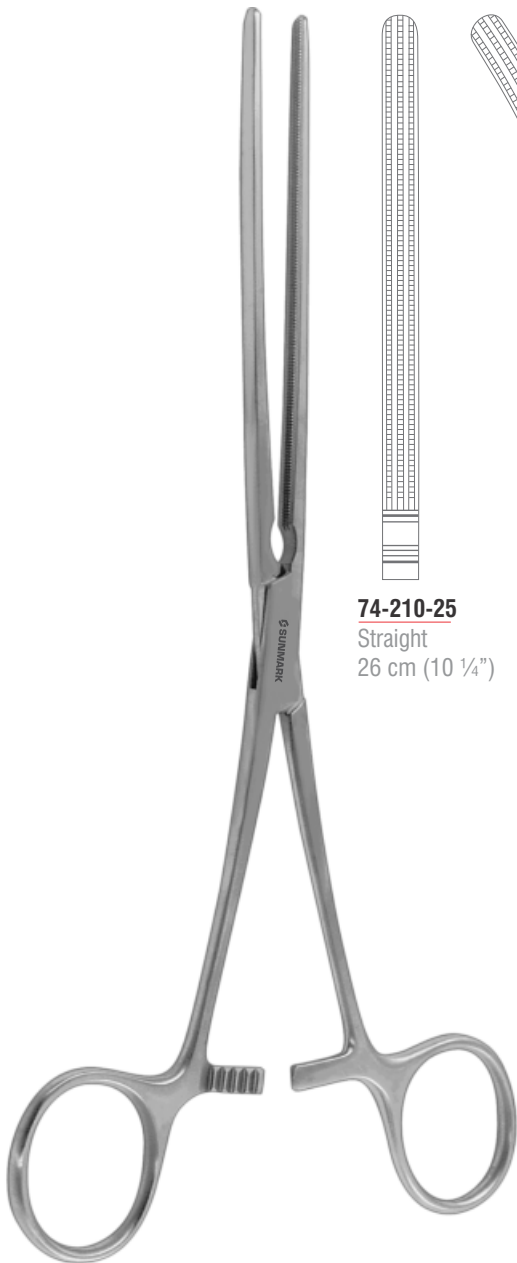

74-210-25
Straight
26 cm (10 1/4")

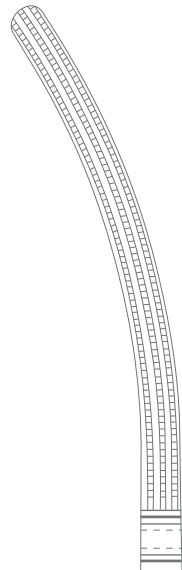

74-211-25
Curved
25 cm (9 3/4")

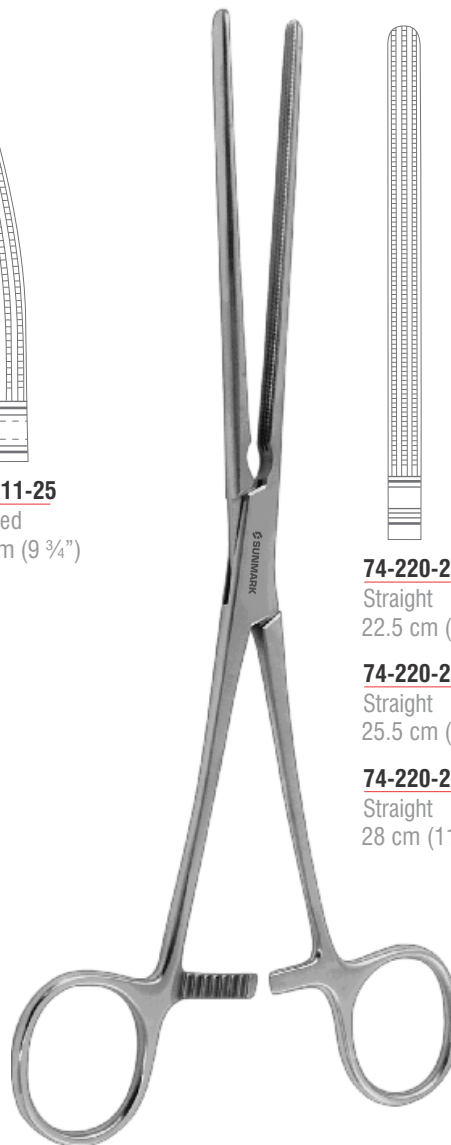

74-220-22
Straight
22.5 cm (8 3/4")

74-220-25
Straight
25.5 cm (10")

74-220-28
Straight
28 cm (11")

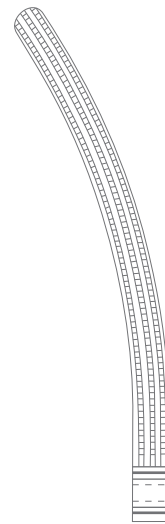

74-221-22
Curved
22 cm (8 3/4")

74-221-25
Curved
25 cm (9 3/4")

74-221-28
Curved
27.5 cm (10 3/4")

Mayo-Robson Atrauma Intestinal Clamp

Mayo-Robson Atrauma Intestinal Clamp

Atrauma™

Atrauma™

Intestinal Clamps
Darmklemmen
Pinzas intestinales
Pinces intestinales
Pinze intestinali

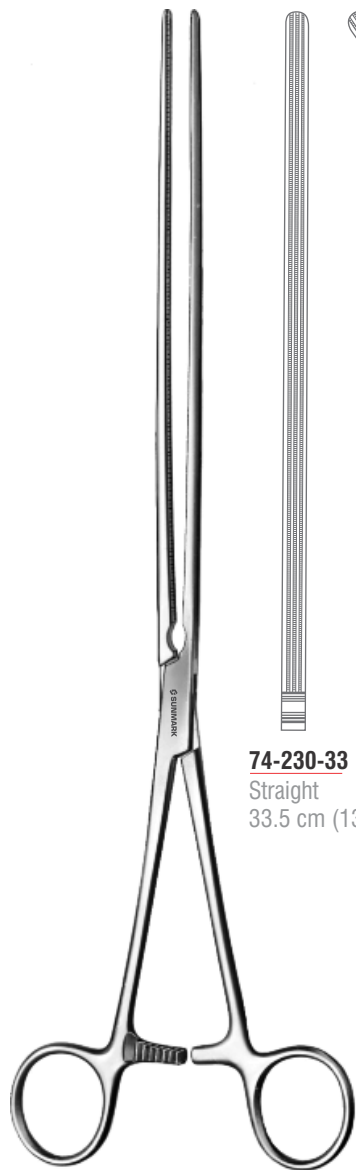

74-230-33
Straight
33.5 cm (13 1/4")

Scudder Atrauma Intestinal Clamp

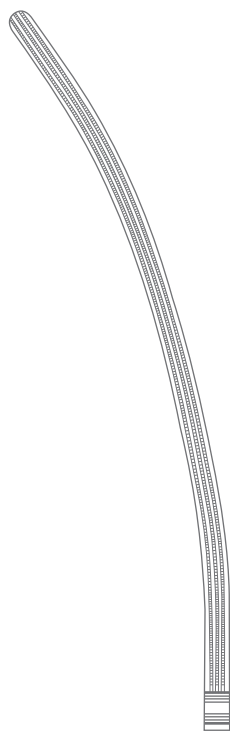

74-231-33
Curved
32.5 cm (12 3/4")

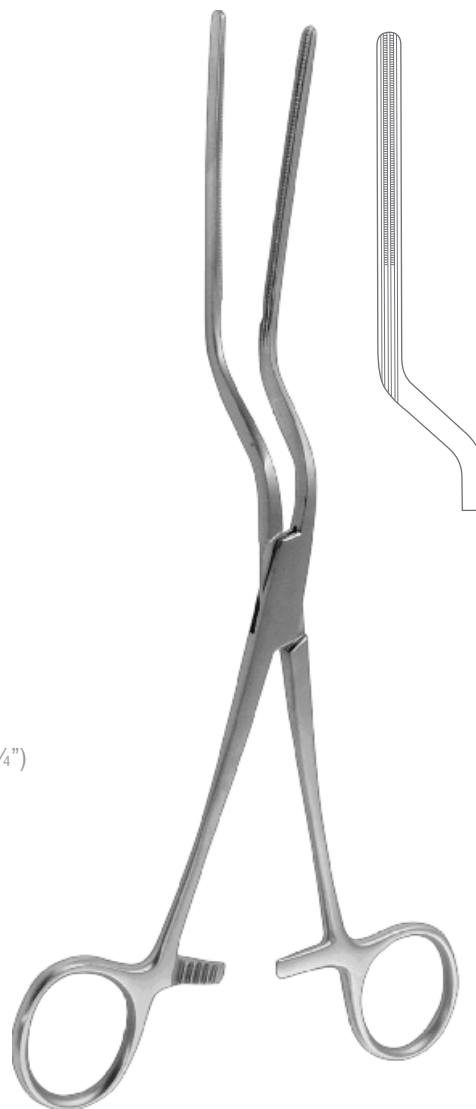

74-241-27
Brunner Atrauma Sigmoid Anastomosis Clamp
Overall Length 27 cm (10 3/4")



Intestinal Clamps
Darmklemmen
Pinzas intestinales
Pincas intestinales
Pinze intestinali

74

STOMACH, INTESTINES, RECTUM

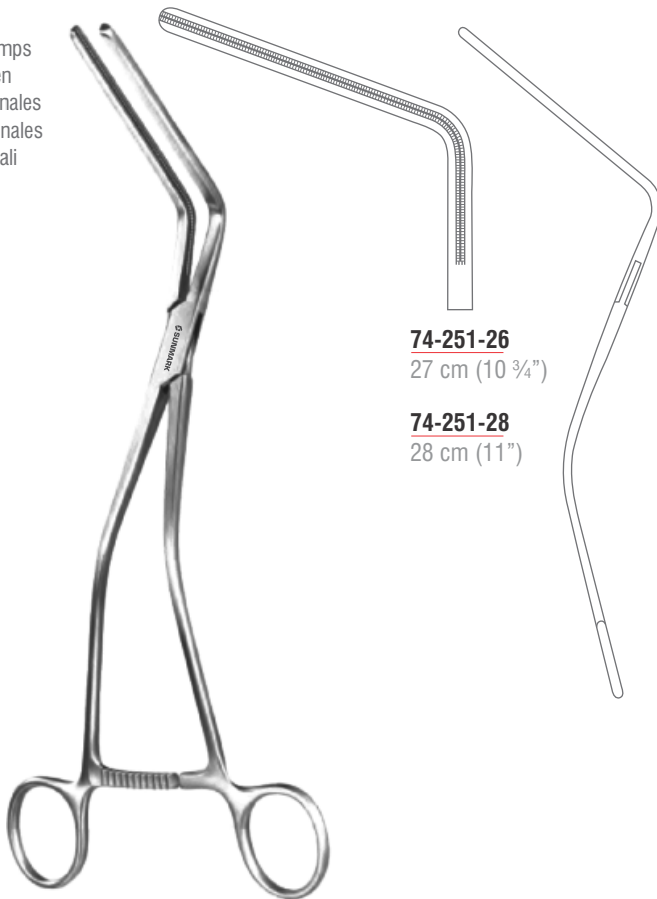

74-251-26
27 cm (10 3/4")

74-251-28
28 cm (11")

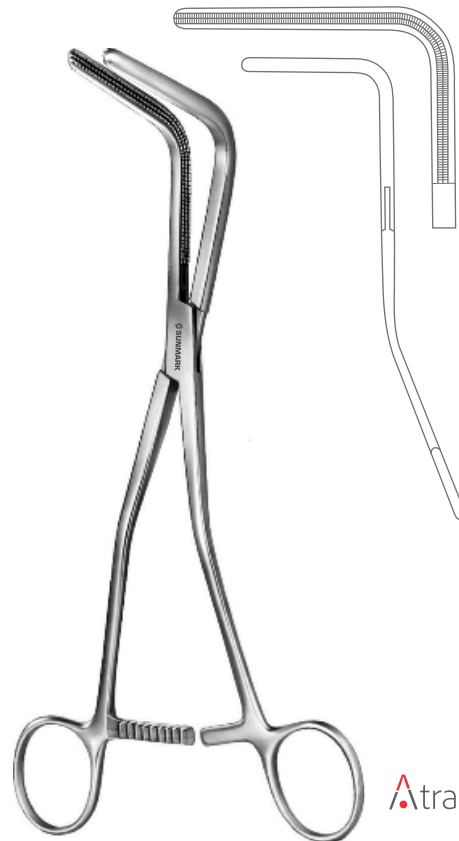

74-255-23
Veidenheimer Atrauma Sigmoid Anastomosis Clamp
Overall Length 25 cm (9 3/4")

Hayes Atrauma Sigmoid Anastomosis Clamp



74-259-24
Fehland Atrauma Sigmoid Anastomosis Clamp
Overall Length 24 cm (9 1/2")

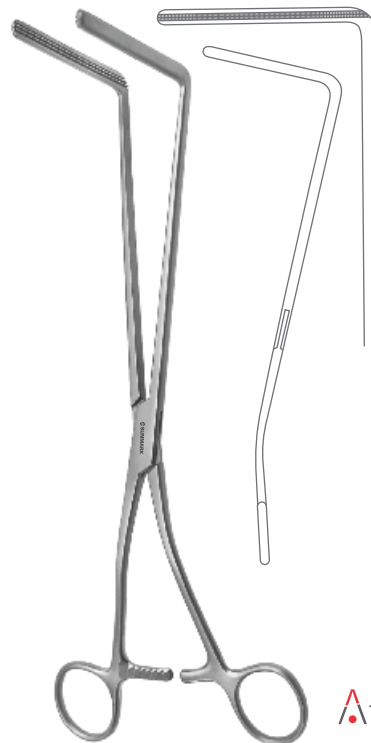

74-261-30
Resano Atrauma Sigmoid Anastomosis Clamp
Overall Length 28 cm (11")





Rectal Specula
Mastdarmspekula
Espéculos rectales
Spéculums rectaux
Specoli rettali



74-290-30
28 cm (11")
74-290-48
48 cm (19")

Savage Intestinal Decompressor
Ø 8.0 mm

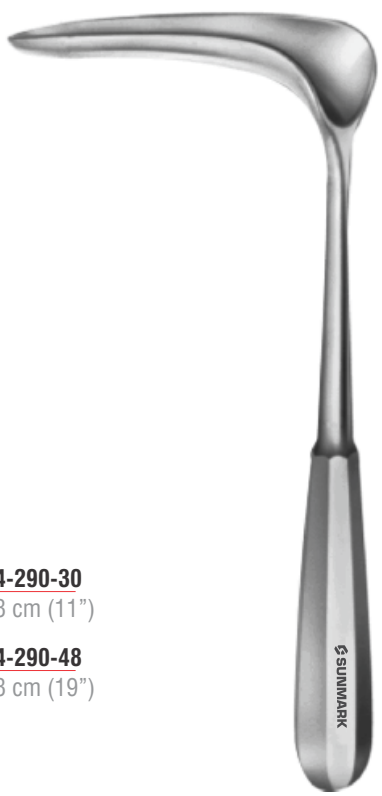

74-301-22
Czerny Rectal Speculum
Overall Length 22 cm (8 3/4")



74-303-22
22 x 64 mm
74-303-30
30 x 76 mm
74-303-36
36 x 76 mm
Hill-Ferguson Rectal Speculum
Overall Length 21 cm (8 1/4")



74-311-20
Pratt Rectal Speculum
80 x 25 mm
Overall Length 20.5 cm (8")



74-321-15
70 x 15 mm
74-323-15
70 x 15 mm
With Fiber Optic
Illumination
Sims Rectal Speculum
Overall Length 15.5 cm (6")



74-327-15
Sims Rectal Speculum
70 x 15 mm
Overall Length 15.5 cm (6")

Rectal Specula
Mastdarmspekula
Espéculos rectales
Spéculums rectaux
Specoli rettali

STOMACH, INTESTINES, RECTUM



74-331-01
60 mm

74-331-02
80 mm

74-331-03
125 mm

74-331-04
150 mm

74-335-22
With Fiber Optic
Illumination



74-341-19
Mathieu Rectal Speculum
90.0 mm
Overall Length 19.5 cm (7 ¾")



74-343-17
Barr Rectal Speculum
70 x 22 mm
Overall Length 17 cm (6 ¾")



74-351-00
Parks Rectal Speculum

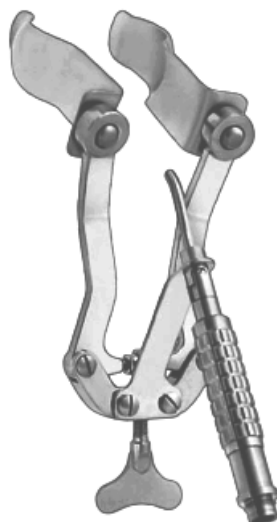

74-355-00
Parks Rectal Speculum
With Fiber Optic Illumination



Rectal Specula, Anuscope
Mastdarmspekula, Anoskop
Espéculos rectales, Anoscopio
Spéculum rectaux, Anuscope
Specoli rettali, Anuscopio



74-361-00
AI26-Parks Rectal Speculum



74-365-00
AI26-Parks Rectal Speculum
With Fiber Optic Illumination



74-381-01
Fig. 1
Ø 16 mm, 60 mm

74-381-02
Fig. 2
Ø 19 mm, 70 mm

74-381-03
Fig. 3
Ø 24 mm, 90 mm

74-381-04
Fig. 4
Ø 24 mm, 130 mm

Hirschmann Anoscope



74-385-01
Fig. 1
Ø 16 mm, 60 mm

74-385-02
Fig. 2
Ø 19 mm, 70 mm

74-385-03
Fig. 3
Ø 24 mm, 90 mm

74-385-04
Fig. 4
Ø 24 mm, 130 mm

Hirschman Anoscope
With Fiber Optic Illumination

Anuscope
Anuskop
Anoscopio
Anuscope
Anoscopio



74-391-00
Ives-Fansler Anoscope
Ø 22 mm, 95 mm

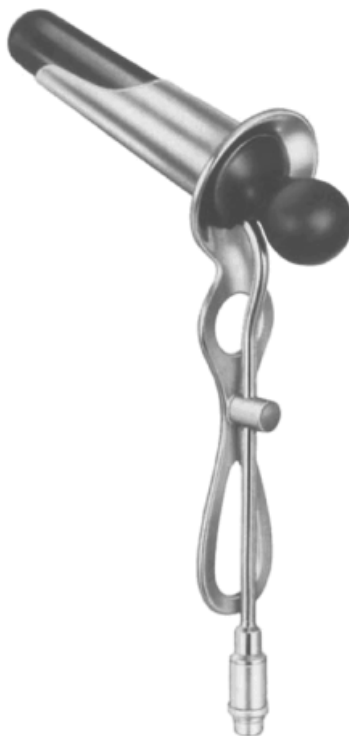

74-395-00
Ives-Fansler Anoscope
With Fiber Optic Illumination
Ø 22 mm, 95 mm



74-401-00
Anoscope
With Obturator
Ø 21 mm, 80 mm



74-403-01
Ø 26 mm, 60 mm

74-403-02
Ø 24 mm, 80 mm

Anoscope
With Obturator



74-411-01
Fig. 1
Ø 22 mm, 50 mm

74-411-02
Fig. 2
Ø 22 mm, 100 mm

74-411-03
Fig. 3
Ø 22 mm, 140 mm

74-411-04
Fig. 4
Ø 22 mm, 200 mm

Kelly Proctoscope



Anuscope
Anuskop
Anoscopio
Anuscope
Anuscopio



74-415-00
Proctoscope
With Obturator
Ø 22 mm, 120 mm



Morgan Proctoscope
With Fiber Optic Illumination

- 74-451-01**
Ø 17 mm, 65 mm
- 74-451-02**
Ø 17 mm, 80 mm
- 74-451-03**
Ø 20 mm, 65 mm
- 74-451-04**
Ø 20 mm, 80 mm
- 74-451-05**
Ø 24 mm, 65 mm
- 74-451-06**
Ø 24 mm, 80 mm



Kelly Sphincteroscope

- 74-471-01**
Fig. 1
Ø 21 mm, 50 mm
- 74-471-02**
Fig. 2
Ø 27 mm, 50 mm

Rectoscopes
 Rektoskope
 Rectoscopios
 Rectoscopes
 Rectotoscopi

STOMACH, INTESTINES, RECTUM

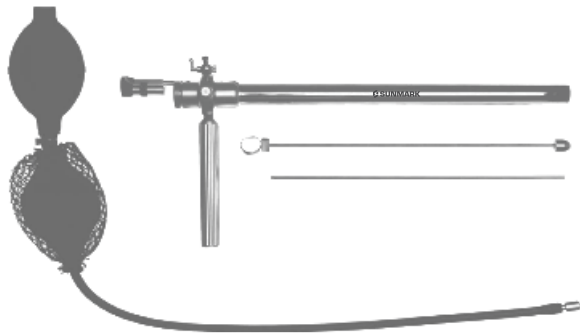

74-500-00
 Rectoscope Complete

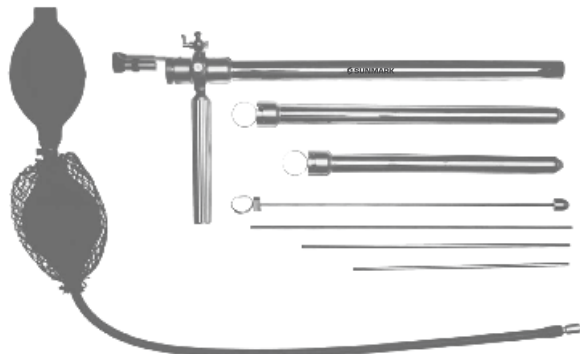

74-510-00
 Strauss Rectoscope Complete

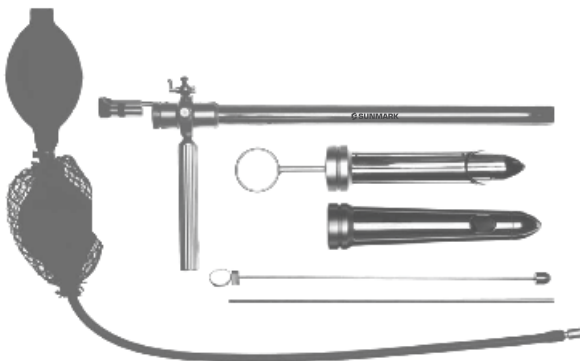

74-520-00
 Recto-Proctoscope Complete

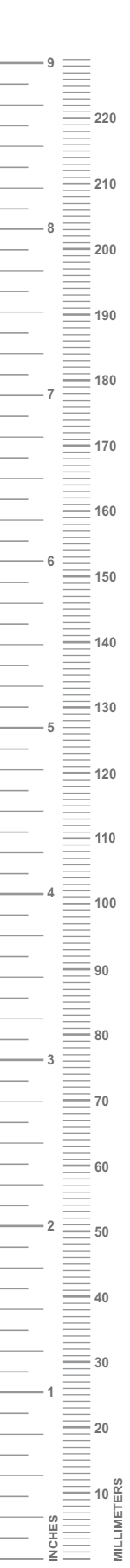

Hemorrhoidal Ligator
Hämorrhoidal-Faßzange
Ligador para hemorroides
Ligateur pour hémorroïdes
Legatore emorroidale



74-601-30
Norwood Rectal Snare
Overall Length 30 cm (11 3/4")



74-607-40
Blue Rectal Aspiration Cannula
10 Charr. Ø 3.3 mm
Overall Length 40 cm (15 3/4")



74-651-00
McGivney Suction Hemorrhoidal Ligator Complete
With 10 mm Suction Head and Charging Cone

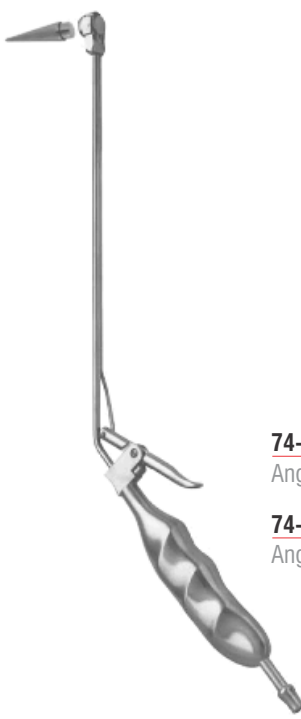

74-655-00
Angled 30° Up
74-657-00
Angled 30° Down

Suction Hemorrhoidal Ligature Complete
With 10 mm Suction Head and Charging Cone

Hemorrhoidal Ligator
Hämorrhoidal-Faßzange
Ligador para hemorroides
Ligateur pour hémorroïdes
Legatore emorroidale

STOMACH, INTESTINES, RECTUM

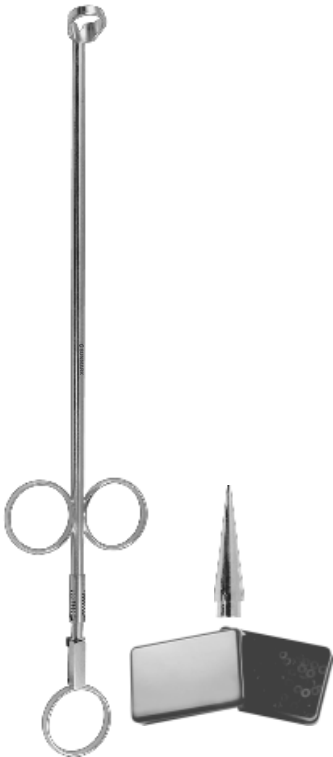

74-670-00
Rudd Hemorrhoidal Ligator Complete
With 12 mm Charging Cone
Overall Length 31.5 cm (12 1/2")



74-675-00
McGivney Hemorrhoidal Ligator Complete
With 12 mm Charging Cone



74-677-00
Ford Dixon Hemorrhoidal Ligator Complete
With 12 mm Charging Cone
Overall Length 31.5 cm (12 1/2")



74-680-00
Rubber Ligator Rings
Pack of 100

Hemorrhoidal Ligator, Rectal Biopsy Forceps
 Hämorrhoidal-Faßzange, Rektum-Biopsiefasszangen
 Ligador para hemorroides, Pinzas para biopsia rectal
 Ligateur pour hémorroides, Pincés pour biopsie rectale
 Legatore emorroidale, Pinze per biopsia rettale

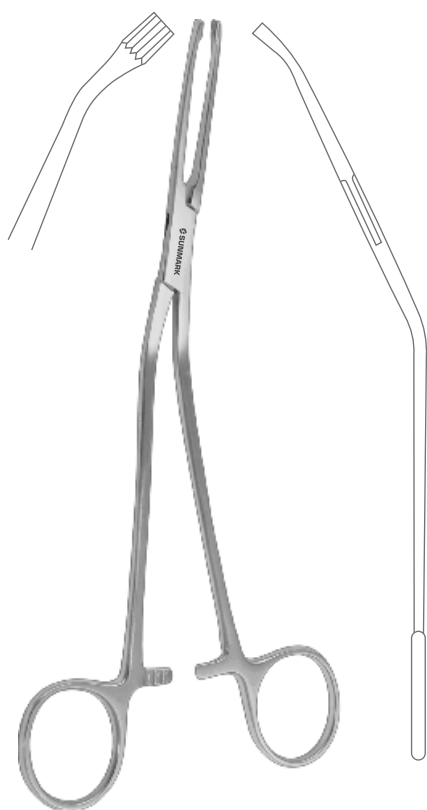

74-691-19
McGivney Hemorrhoidal Grasping Forcep
 Overall Length 19 cm (7 1/2")



Yeoman (Turrell) Rectal Biopsy Forcep Complete
 Overall Length 42 cm (16 1/2")



74-735-01
 Straight



74-735-02
 Down



74-735-03
 Straight



74-735-04
 Down



74-735-05
 Straight

Kidney Stone Forceps
Nierensteinzangen
Pinzas para cálculos renales
Pinces pour les calculs du bassin
Pinze per calcoli renali



87-011-01
Vasectomy Dissecting Forcep
Overall Length 14.5 cm (5 3/4")



87-014-02
Vasectomy Fixation Forcep
Overall Length 14.5 cm (5 3/4")



87-031-01
Angled Right

87-031-02
Angled Left

McDougal Prostatectomy Clamp
Overall Length 25.5 cm (10")

Kidney Stone Forceps
Nierensteinzangen
Pinzas para cálculos renales
Pinces pour les calculs du bassin
Pinze per calcoli renali



87-051-23
Fig. 1
23 cm (9")

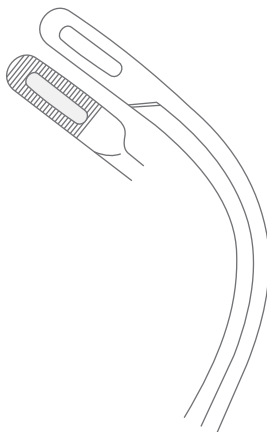

87-053-21
Fig. 2
21 cm (8 1/4")

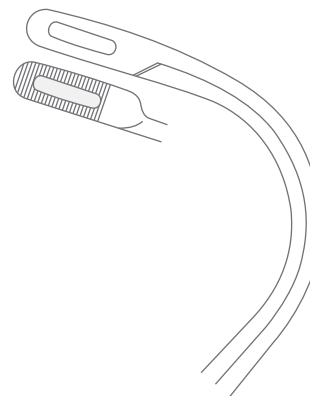

87-055-19
Fig. 3
19 cm (7 1/2")



Randall Kidney Stone Forcep

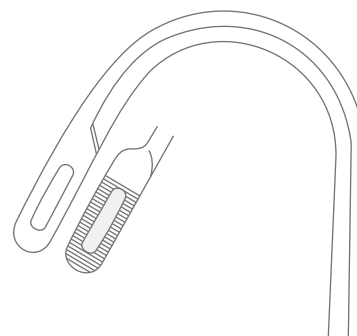

87-057-18
Fig. 4
18.5 cm (7 1/2")

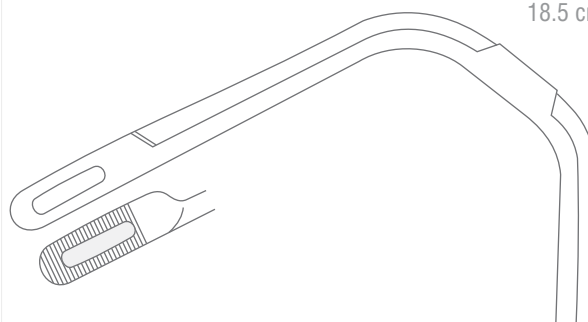

87-059-19
Fig. 5
19 cm (7 1/2")

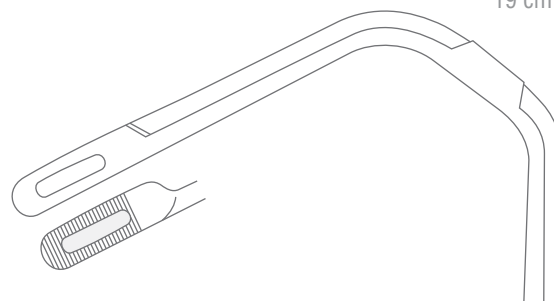

87-061-19
Fig. 6
19 cm (7 1/2")

Kidney Stone Forceps
Nierensteinzangen
Pinzas para cálculos renales
Pinces pour les calculs du bassinet
Pinze per calcoli renali



Randall Kidney Stone Forcep
Slender Pattern

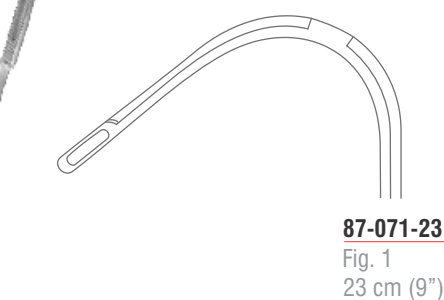

87-071-23
Fig. 1
23 cm (9")

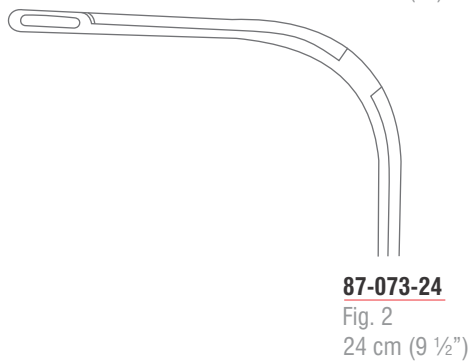

87-073-24
Fig. 2
24 cm (9 1/2")



Heiming Kidney Stone Forcep

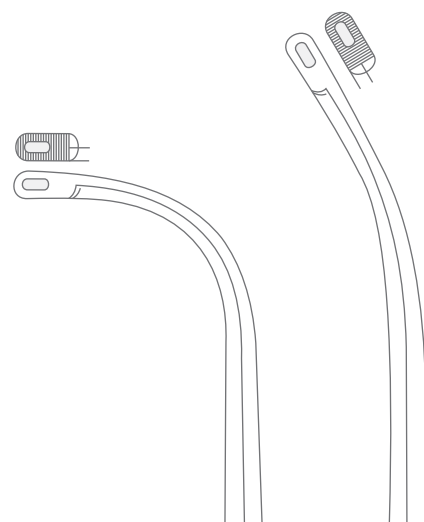

87-081-16
Fig. 1
16 cm (6 1/4")

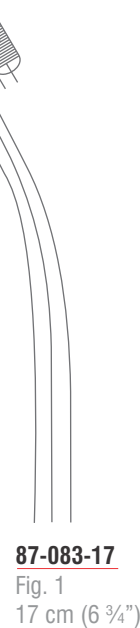

87-083-17
Fig. 1
17 cm (6 3/4")

Kidney Stone Forceps
Nierensteinzangen
Pinzas para cálculos renales
Pincers pour les calculs du bassin
Pinze per calcoli renali



Elsaesser Nephrectomy Forcep
Overall Length 21 cm (8 1/4")

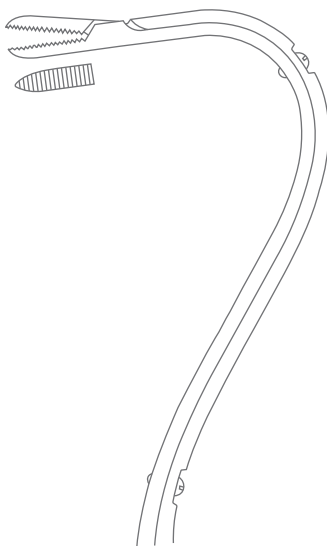

87-091-01
Fig. 1

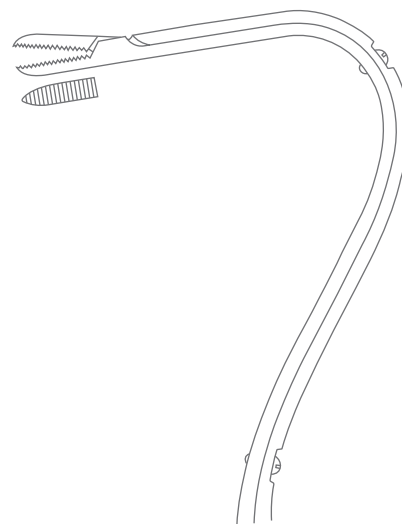

87-091-02
Fig. 2

Gall Duct Dilators
 Gallenkanaldilatatore
 Dilatadores para conducto biliar
 Dilatateurs pour les voies biliaires
 Dilatatori per condotti biliari



87-150-00
Bakes Gall Duct Dilators
 Set of 13 Ref: 87-150-01 to
 87-150-13



Bakes Gall Duct Dilators
 Overall Length 32 cm (12 1/2")

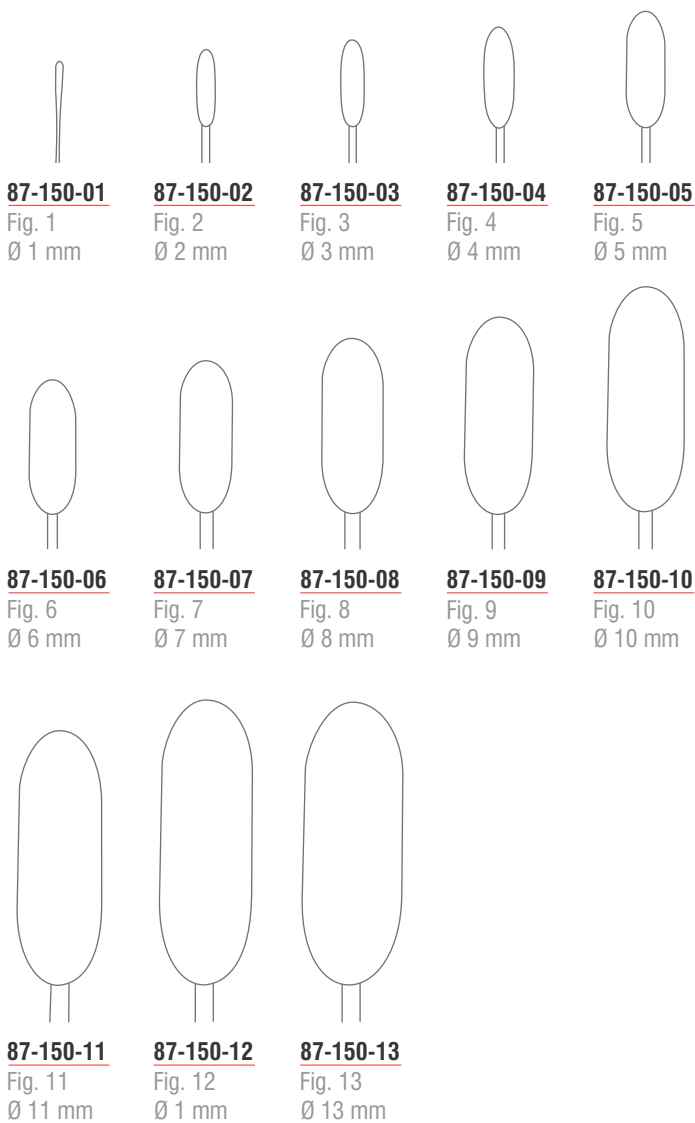

Gall Stone Forceps
Gallensteinzangen
Pinzas para cálculos biliares
Pinces pour calculs biliaires
Pinze per calcoli biliari



Bakes Gall Stone Forcep
Overall Length 21 cm (8 1/4")

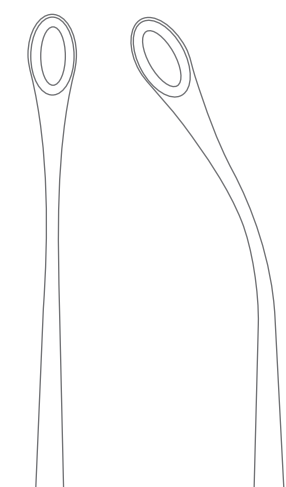

87-180-20
Straight

87-181-20
Curved



Mayo-Bakes Gall Stone Forcep
Overall Length 21 cm (8 1/4")

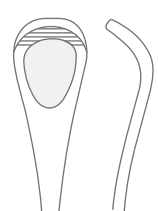

87-184-20
Straight

87-185-20
Curved

Gall Stone Forceps
Gallensteinzangen
Pinzas para cálculos biliares
Pinces pour calculs biliaires
Pinze per calcoli biliari



87-189-22
Mixer Gall Stone Forcep
Overall Length 22 cm (8 3/4")



87-193-23
Desjardins Gall Stone Forcep
Overall Length 23 cm (9")

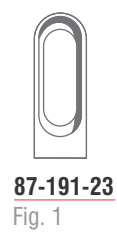

87-191-23
Fig. 1



87-193-23
Fig. 2

Prostatic Retractors
 Prostatahaken
 Separadores para próstata
 Ecarteurs prostatiques
 Divaricatori prostatici



Luer-Koerte Gall Stone Scoop
 Overall Length 32 cm (12 1/2")



87-250-01
 Fig. 000
 Ø 2.7 mm



87-250-02
 Fig. 00
 Ø 3.4 mm



87-250-03
 Fig. 0
 Ø 4.3 mm



87-250-04
 Fig. 1
 Ø 5.5 mm



87-250-05
 Fig. 2
 Ø 6.6 mm



87-250-06
 Fig. 3
 Ø 8.0 mm



87-250-07
 Fig. 4
 Ø 11.0 mm



87-250-08
 Fig. 5
 Ø 15.0 mm



Desjardins Gall Duct Probe and Gall Stone Scoop
 Overall Length 30 cm (12")



87-252-06
 Ø 6.0 mm

87-252-07
 Ø 7.0 mm

87-252-08
 Ø 8.0 mm

87-252-09
 Ø 9.0 mm

Prostatic Retractors
 Prostatahaken
 Separadores para próstata
 Ecarteurs prostatiques
 Divaricatori prostatici



87-260-35
Moynihan Gall Stone Probe and Scoop
 Malleable Tip Ø 5.0 mm
 Overall Length 36.5 cm (14 1/2")



87-262-27
Moyo Gall Stone Scoop
 Overall Length 27.5 cm (10 3/4")



87-264-28
Moore Gall Stone Scoop
 Overall Length 28 cm (11")



87-290-15
 15 Fr.

87-290-18
 18 Fr.

87-290-20
 20 Fr.

Desjardins Gall Stone Probe
 Overall Length 28 cm (11")

Prostatic Retractors
 Prostatahaken
 Separadores para próstata
 Ecarteurs prostatiques
 Divaricatori prostatici



Young Prostatic Retractor

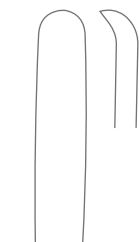

87-301-22
 22 cm (8 3/4")



87-305-21
 21.5 cm (8 1/2")

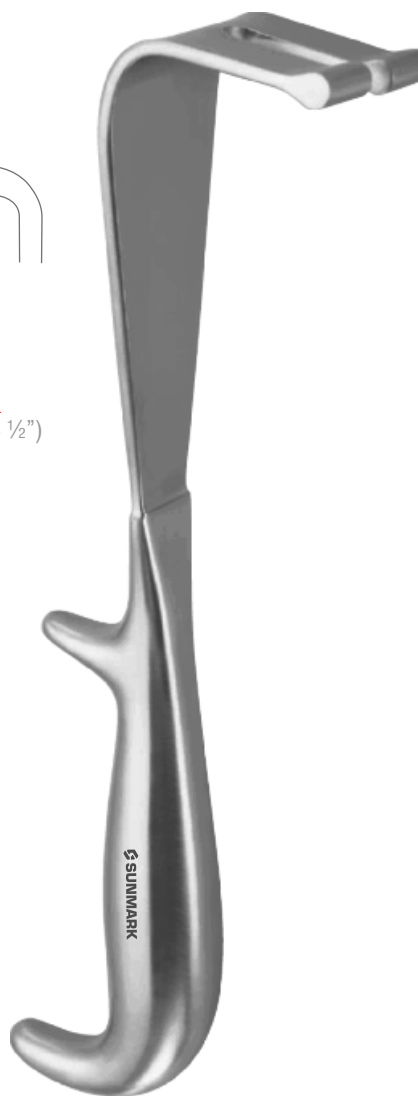

87-309-23
Young Prostatic Retractor
 Overall Length 23 cm (9")

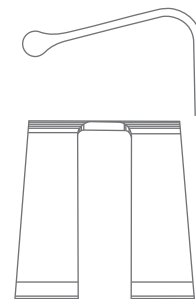

Capsule Forceps
Kapselasszangen
Pinzas capsulares
Pinces pour saisir les capsules
Pinze per afferrare capsule



Atrauma™

87-451-24
Martin Atrauma Capsule Forcep
Overall Length 24.5 cm (9 1/2")

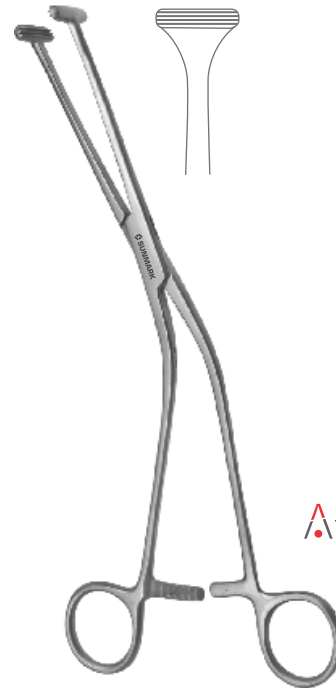

Atrauma™

87-453-22
Millin Atrauma Capsule Forcep
Overall Length 22.5 cm (8 3/4")

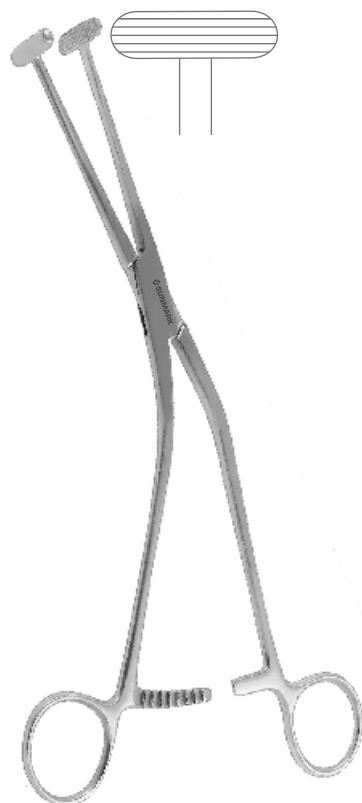

87-457-24
Millin Capsule Forcep
Overall Length 24.5 cm (9 1/2")

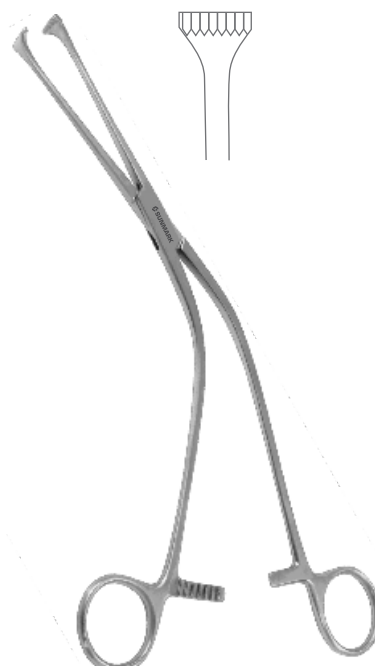

87-461-22
Millin Capsule Forcep
Overall Length 22 cm (8 3/4")

Urethral Sounds
Harnröhrenbougies
Bujías uretrales
Bougies urétrales
Candelette dilatatrici



87-501-00
Van Buren Urethral Sound / Dilating Bougie
Set of 15 Ref: 87-501-08 to 87-501-36



Van Buren Urethral Sound / Dilating Bougie
Overall Length 27 cm (10 3/4")

- | | |
|--------------------------------------|--------------------------------------|
| <u>87-501-08</u>
8 Charr. | <u>87-501-24</u>
24 Charr. |
| <u>87-501-10</u>
10 Charr. | <u>87-501-26</u>
26 Charr. |
| <u>87-501-12</u>
12 Charr. | <u>87-501-28</u>
28 Charr. |
| <u>87-501-14</u>
14 Charr. | <u>87-501-30</u>
30 Charr. |
| <u>87-501-16</u>
16 Charr. | <u>87-501-32</u>
32 Charr. |
| <u>87-501-18</u>
18 Charr. | <u>87-501-34</u>
34 Charr. |
| <u>87-501-20</u>
20 Charr. | <u>87-501-36</u>
36 Charr. |
| <u>87-501-22</u>
22 Charr. | |

Urethral Sounds
 Harnröhrenbougies
 Bujías uretrales
 Bougies urétrales
 Candelette dilatatrici

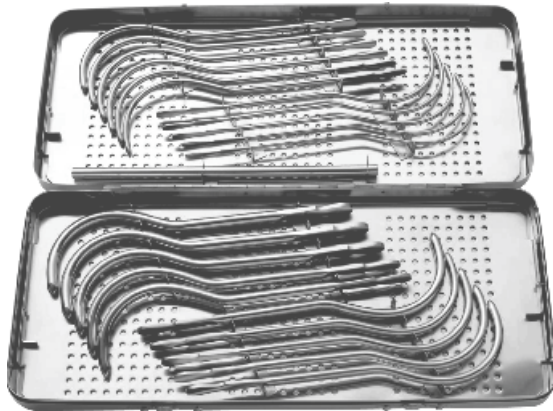
87-511-00
Guyon Urethral Sound/Dilating Bougie

Set of 24 Ref: 87-511-10 to 87-511-30 and 87-580-03 to 87-580-06 in Metal Case



87-511-10
10 Charr.

87-511-11
11 Charr.

87-511-12
12 Charr.

87-511-13
13 Charr.

87-511-14
14 Charr.

87-511-15
15 Charr.

87-511-16
16 Charr.

87-511-17
17 Charr.

87-511-18
18 Charr.

87-511-19
19 Charr.

87-511-20
20 Charr.

87-511-21
21 Charr.

87-511-22
22 Charr.

87-511-23
23 Charr.

87-511-24
24 Charr.

87-511-25
25 Charr.

87-511-26
26 Charr.

87-511-27
27 Charr.

87-511-28
28 Charr.

87-511-30
30 Charr.



87-515-10
10 Charr.

87-515-12
12 Charr.

87-515-14
14 Charr.

87-515-16
16 Charr.

87-515-18
18 Charr.

87-515-20
20 Charr.

Guyon Urethral Sound / Dilating Bougie

Overall Length 26.5 cm (10 1/2")

Female Catheter

Overall Length 15 cm (6")

Urethrotome
Urethrotom
Uretrótomo
Urétrotome
Uretrotomi,



87-519-00
Catheter Introducer
Overall Length 46 cm (18")



87-550-00
Otis Urethrotome
With 2 Knives and 3 Tips

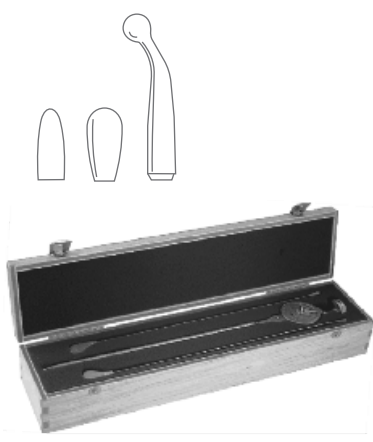

87-550-01
Otis Spare Blade



87-700-00
Knutson Urethrography Instrument

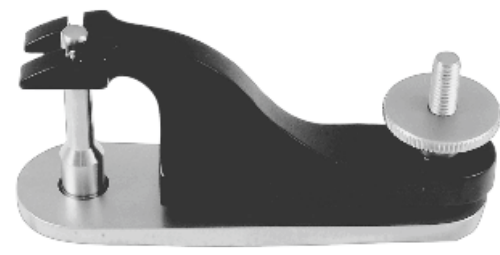

Gomco Circumcision Clamp

87-720-08
Ø 8 mm

87-720-11
Ø 11 mm

87-720-13
Ø 13 mm

87-720-16
Ø 16 mm

87-720-21
Ø 21 mm

87-720-26
Ø 26 mm

87-720-32
Ø 32 mm

Circumcision Instruments
Circumcisions-Instrumente
uretrografía y circuncisión
urétrographie et circoncision
uretrografia e circoncisione



87-740-00
Mogen Circumcision Clamp
Overall Length 7.5 cm (3")

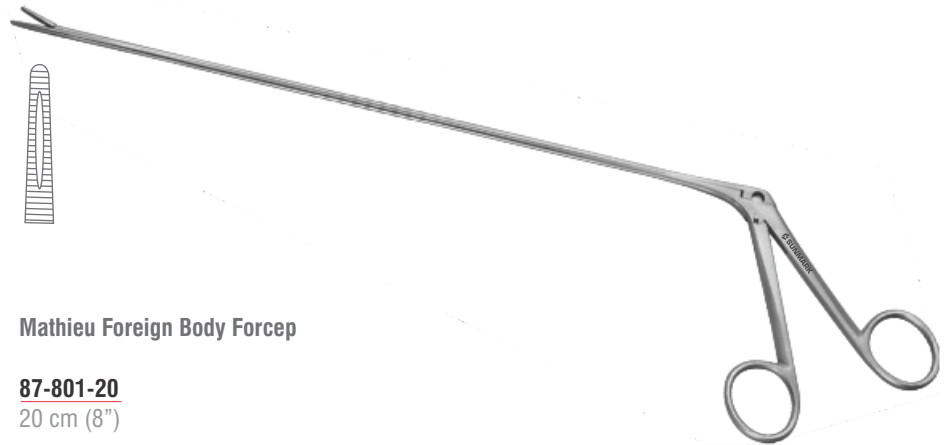

Mathieu Foreign Body Forcep

87-801-20
20 cm (8")

87-801-28
28 cm (11")

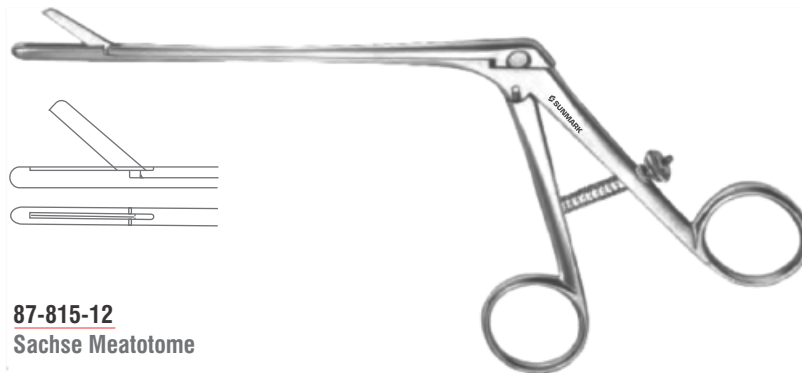

87-815-12
Sachse Meatotome

Circumcision Instruments
 Circumcisions-Instrumente
 uretrografia y circuncisión
 urétrographie et circoncision
 uretrografia e circoncisione

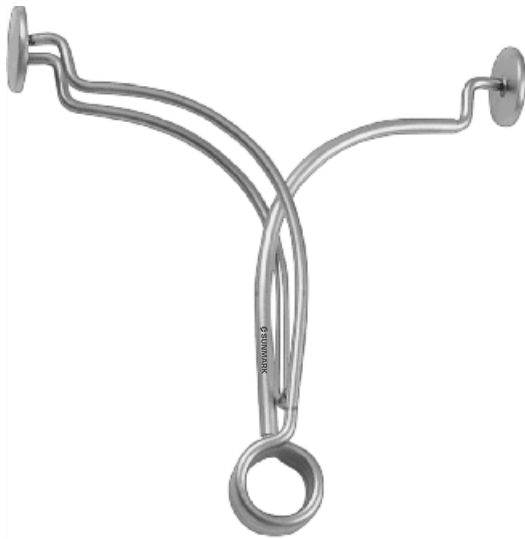

87-851-08
Stockman Penis Clamp
 Overall Length 8 cm (3 1/4")



87-861-11
Strauss Penis Clamp
 Overall Length 11 cm (4 1/2")



87-870-13
Collingwood-Stewart Hernia Ring Forcep
 Overall Length 13 cm (5")

Round Bowls
Runde Schüsseln
Cubetas redondas
Cuvettes rondes
Scodelle rotonde



Round Bowl

49-010-16

Ø 150 x 74 mm, 750 ccm

49-010-17

Ø 160 x 65 mm, 1000 ccm

49-010-22

Ø 220 x 70 mm, 2000 ccm

49-010-24

Ø 240 x 95 mm, 3000 ccm

49-010-27

Ø 260 x 130 mm, 4500 ccm

49-010-31

Ø 300 x 105 mm, 6000 ccm

49-010-34

Ø 320 x 140 mm, 8500 ccm

49-010-38

Ø 380 x 125 mm, 11000 ccm

49-010-41

Ø 400 x 150 mm, 14000 ccm



Round Bowl

49-020-33

Ø 330 x 90 mm, 6000 ccm

49-022-33

Ø 330 x 115 mm, 8000 ccm



Round Bowl

49-026-11

Ø 110 x 25 mm, 150 ccm

49-028-11

Ø 110 x 40 mm, 250 ccm

Round Bowls, Flat Dishes
 Runde Schüsseln, Flachschen
 Cubetas redondas, Cubetas planas
 Cuvettes rondes, Cuvettes plates
 Scodelle rotonde, Scodelle piatte



49-030-11
 Lid Only



Mixing Bowl/ Solution Bowl



Round Dish

49-050-04
 Ø 40 x 19 mm, 20 ccm

49-050-12
 Ø 128 x 55 mm, 350 ccm

49-050-06
 Ø 61 x 30 mm, 70 ccm

49-050-14
 Ø 147 x 65 mm, 500 ccm

49-050-08
 Ø 80 x 40 mm, 140 ccm

49-050-16
 Ø 167 x 75 mm, 900 ccm

49-050-11
 Ø 116 x 50 mm, 250 ccm

49-050-18
 Ø 187 x 85 mm, 1300 ccm

49-060-11
 Ø 116 x 35 mm, 200 ccm

49-060-16
 Ø 167 x 45 mm, 500 ccm

49-060-12
 Ø 128 x 38 mm, 300 ccm

49-060-18
 Ø 187 x 45 mm, 800 ccm

49-060-14
 Ø 147 x 40 mm, 400 ccm

Measurers, Universal Trays
 Messbecher, Mehrzweckschalen
 Vaso-medidas, Bandejas universales
 Mesures graduées, Plateaux universaux
 Bicchieri graduati, Bacinelle universali



49-064-11
Round Dish
 Ø 110 x 28 mm, 150 ccm



49-070-01
Graduated Measure
 100 ccm



Graduated Measure

49-072-01
 250 ccm

49-072-02
 500 ccm

49-072-03
 1000 ccm

49-072-04
 2000 ccm



Petri Dish

49-090-00
 Ø 100 x 20 mm, With Lid

49-090-01
 Ø 96 x 20 mm, Without Lid

49-090-02
 Lid Only



Universal Tray

49-100-23
 230 x 155 x 30 mm

49-100-35
 350 x 240 x 36 mm

49-100-30
 300 x 175 x 30 mm

49-100-40
 470 x 320 x 50 mm

49-100-31
 300 x 175 x 40 mm



Instrument Tray

49-110-21
 210 x 160 x 10 mm

49-110-35
 350 x 240 x 10 mm

49-110-24
 240 x 180 x 10 mm

49-110-40
 400 x 270 x 20 mm

49-110-30
 310 x 150 x 10 mm

49-110-42
 420 x 280 x 10 mm

49-110-31
 310 x 210 x 10 mm

Universal Trays, Instrument Trays, Metal Jars
 Mehrzweckschalen, Instrumententablets, Standgefäße
 Bandejas universales, Bandejas para instrumentos, Tarros metálicos
 Plateaux universaux, Plateaux pour instruments, Récipients en métal
 Bacinelle universali, Bacinelle per strumenti, Recipienti metallici



49-120-23
Universal Tray
 235 x 190 x 40 mm



Instrument Tray
 Without Cover



Instrument Tray
 With Cover

49-122-01
 150 x 100 x 25 mm

49-122-05
 350 x 250 x 50 mm

49-122-02
 200 x 150 x 40 mm

49-122-06
 350 x 300 x 50 mm

49-122-03
 250 x 200 x 40 mm

49-122-07
 400 x 300 x 50 mm

49-122-04
 250 x 200 x 40 mm

49-122-08
 450 x 350 x 50 mm

49-124-01
 150 x 100 x 25 mm

49-124-05
 350 x 250 x 50 mm

49-124-02
 200 x 150 x 40 mm

49-124-06
 350 x 300 x 50 mm

49-124-03
 250 x 200 x 40 mm

49-124-07
 400 x 300 x 50 mm

49-124-04
 250 x 200 x 40 mm

49-124-08
 450 x 350 x 50 mm



Round Bowls, Metal Jars
 Runde Schüsseln, Standgefäße
 Cubetas redondas, Tarros metálicos
 Cuvettes rondes, Récipients en métal
 Scodelle rotonde, Recipienti metallici



49-130-22
Round Bowl
 Ø 220 x 70 mm



Metal Jar

49-150-30
 Ø 30 x 90 mm

49-150-75
 Ø 75 x 100 mm

49-150-50
 Ø 50 x 100 mm

49-150-76
 Ø 75 x 130 mm

49-150-51
 Ø 50 x 130 mm

49-150-77
 Ø 75 x 175 mm

49-150-52
 Ø 50 x 175 mm

49-150-98
 Ø 100 x 175 mm

49-150-99
 Ø 100 x 200 mm



Lid Only

49-153-50
 Ø 50 mm, Closed

49-150-99
 Ø 50 mm, With Triangular Opening

49-153-75
 Ø 75 mm, Closed

49-150-99
 Ø 75 mm, With Triangular Opening

49-153-99
 Ø 100 mm, Closed

49-150-99
 Ø 100 mm, With Triangular Opening

Instrument Trays
 Instrumententabletts
 Bandejas para instrumentos
 Plateaux pour instruments
 Bacinelle per strumenti



Instrument Box

49-200-16 165 x 85 x 35 mm **49-200-26** 260 x 150 x 50 mm

49-200-20 200 x 100 x 35 mm **49-200-27** 270 x 235 x 50 mm

49-200-21 200 x 100 x 50 mm **49-200-30** 300 x 200 x 50 mm

49-200-23 230 x 130 x 50 mm **49-200-33** 325 x 275 x 50 mm

Lid With knob

49-220-16 165 x 85 x 35 mm **49-220-30** 300 x 200 x 50 mm

49-220-20 200 x 100 x 35 mm **49-220-32** 324 x 275 x 50 mm

49-220-21 200 x 100 x 50 mm **49-220-33** 325 x 275 x 50 mm

49-220-23 230 x 130 x 50 mm **49-220-42** 420 x 80 x 40 mm

49-220-26 260 x 150 x 50 mm **49-220-43** 420 x 175 x 50 mm

49-220-27 270 x 235 x 50 mm

Lid Without knob



49-230-20
Instruments Box
 205 x 105 x 35 mm



Dressing Jar

49-250-06 Ø 75 x 60 mm **49-254-08** Ø 125 x 80 mm

49-250-07 Ø 75 x 75 mm **49-254-12** Ø 125 x 125 mm

49-252-06 Ø 100 x 60 mm **49-256-15** Ø 150 x 150 mm

49-252-10 Ø 100 x 100 mm



Cups
Becher
Tarras
Réipients
Recipienti



Medicine Cup

49-300-25

25 cc

49-300-50

50 cc



49-310-20
Medicine Spoon
20 cc



49-320-75
Tablet Tray
Ø 75 x 12 mm



49-350-00
Metal Cup
With Lid
Ø 90 x 90 mm



49-360-75
Denture Cup
With Lid
Ø 75 x 50 mm



49-370-75
Sputum Cup
Ø 75 x 80 mm



Kidney Dish

49-400-17
170 x 100 x 35 mm

49-400-20
200 x 140 x 38 mm

49-400-25
250 x 140 x 40 mm

49-400-27
275 x 150 x 45 mm



49-402-25
Lid For Kidney Dish
252 mm

Bed Pans, Triangular Basins, Placenta Pan
 Stechbecken, Dreieckschale, Plazentabecken
 Siletas, Cubetas triangulares, Cubeta para placenta
 Bassins réniformes, Bassins triangulaires, Bassin pour placenta
 Bacinelle reniformi, Padelle, Bacinelle triangolari, Bacinella per placenta



Bed Pan

49-500-23
 Ø 235 mm

49-500-31
 Ø 310 mm



49-510-00
 Bed Pan



49-512-00
 Male Urinal



49-514-00
 Female Urinal



49-520-30
 Graduated Triangular Basin
 With Handle
 600 ml



49-522-30
 Graduated Triangular Basin
 Without Handle
 600 ml



49-530-36
 Placenta Pan

Our Range of Best Selling Instruments
GENERAL INSTRUMENTS CATALOGUE



SUNMARK
I N S T R U M E N T S

Mark Of Quality

+92 (331) 661 9646

www.sunmarkinstruments.com

sales@sunmarkinstruments.com

Small Industrial Estate Sialkot-51310 Punjab Pakistan

