



**SUNMARK**  
INSTRUMENTS

*Mark Of Quality*



## OPHTHALMIC INSTRUMENTS CATALOGUE

Our Range of Best Selling Instruments

Ophthalmic Surgery Instruments ◆ Augenheilkunde Instrumente ◆ Oftalmologia cirugía Instrumentos

Ophtalmique chirurgie Instruments ◆ Oftalmica chirurgia Strumenti

## INSTRUCTIONS FOR REPROCESSING OF REUSABLE SURGICAL INSTRUMENTS

The following instructions are for all reusable medical devices supplied by Sunmark Instruments Ltd, unless stated otherwise with the packaging of the product. These instructions are intended for use only by persons with the required specialist knowledge and training.

### Warnings

- Follow instructions and warnings as issued by the manufacturers of any decontaminants, disinfectants and cleaning agents. Wherever possible avoid use of mineral acids and harsh, abrasive agents.
- No part of the process shall exceed 140 °C.
- Some sensitive materials (e.g. Aluminium) are damaged by high alkaline solutions (pH>10).
- Devices with long, narrow cannula, hinges and blind holes require particular attention during cleaning.

**Note:** When reprocessing medical devices, always handle with care, wearing protective clothing, gloves and eye-wear in accordance with local health & safety procedures.

### Limitations on Reprocessing

- Repeated processing has minimal effect on these instruments.
- End of life normally determined by wear and damage in use.
- Any specific limitations on the number of reprocessing cycles shall be made available with instrument.

### From Point of Use

Whenever possible, do not allow blood, debris or bodily fluids to dry on instruments. For best results and to prolong the life of the medical device reprocess immediately after use. If they cannot be reprocessed immediately, use an enzymatic foam spray cleaner to help prevent soil from drying.

### Preparation for Decontamination

- Process all the instruments as soon as it is reasonably practical following use.
- Disassemble only where intended, without the use of tools unless specifically provided by the manufacturer. Instructions for dis assembly are available with the device, where required.

### Cleaning: Automated

- Use only either CE marked or validated washer-disinfector machines and low foaming, non-ionizing cleaning agents and detergents following the manufacturer's instructions for use, warnings, concentrations and recommended cycles.
- Load instruments carefully, with any box joints and hinges open and so that any fenestration in instruments can drain.
- Place heavy instruments with care in the bottom of containers, taking care not to overload wash baskets.
- Place instruments with concave surfaces facing down to prevent pooling of water.
- Where possible, use appropriate attachments to flush inside reamers and devices with lumens or cannula.
- Ensure that soft, high purity water which is controlled for bacterial endo-toxins is used in the final rinse stage.

**Note:** Automated cleaning may not be suitable for all lumens and cannula in which case clean manually with a water jet gun, if available, and an appropriate brush (and stilette if provided) that reaches the depth of the feature. After manually cleaning, pass all devices through an automatic cleaning cycle to achieve disinfection.

**Note:** These instruments have been validated using a washer-disinfector cycle validated to include two cold rinses at <35 °C, a detergent cycle and a rinse cycle both at >50°C, a disinfection cycle operating at a temperature of between 80 °C and 90 °C for a minimum holding time of 1 minute (actual holding time in excess of 2 minutes 50 seconds) and a 20 minute drying cycle. The detergent used was low foaming, non-ionizing spray wash detergent cleaner (max 12pH) and the rinse aid a neutral pH low foaming, non-ionic surfactant with isopropyl alcohol.

### Cleaning: Manual

- Manual cleaning is not advised if an automatic washer-disinfector is available. If the equipment is not available, use the following process:-
1. Use a double sink system (wash/rinse) dedicated for instrument cleaning (not used for hand washing). Ensure that the water temperature does not exceed 35 of the re-processor to ensure that the reprocessing as actually performed using equipment, materials and personnel in the reprocessing facility achieve the desired result. This requires validation and routine monitoring of the process. Likewise any deviation by the re-processor from the instructions provided must be properly evaluated for effectiveness and potential adverse consequences.
  2. In the first sink, keeping the instrument submerged, with an autoclavable brush, apply CE marked cleaning solution to all surfaces until all soil has been removed. Pay particular attention to serrations, teeth, ratchets and hinges, always brushing away from the body and avoiding splashing. Ensure rongeurs and hinged instruments are thoroughly cleaned in both open and closed positions.
  3. In the second sink, rinse instruments thoroughly with soft, high purity water which is controlled for bacterial endotoxins, so that the water reaches all parts of the instrument, then carefully hand dry or use a drying cabinet.

**Note:** Manual Cleaning is NOT a disinfection process: When manual cleaning is used it may not be possible to disinfect the device prior to further handling.

### Cleaning Inspection

- After cleaning visually inspect, visually inspect all surfaces, cannulations, ratchets, joints, holes and lumens for complete removal of soil and fluids. If ANY soil or fluid is still visible, return the instrument for repeat decontamination.

### Maintenance

- Apply surgical grade lubricant to hinges, joints and moving parts as per the lubricant manufacturer's instructions.

Continued on next page

### Inspection and Functional Testing

- Visually inspect and check: - all instruments for damage and wear; cutting edges are free from nicks and present a continuous edge; jaws and teeth align correctly; all articulated instruments have a smooth movement without excess play; locking mechanisms (such as ratchets) fasten securely and close easily; long, slender instruments are not distorted; any component parts fit and assemble correctly with mating components.
- Remove for repair and replacement any blunt, worn out, flaking, fractured or damaged instruments.

**Note:** If an instrument is returned to the manufacturer / supplier, the instrument must be decontaminated and sterilized and be accompanied with the relevant documented evidence.

### Packaging

- All instruments to be packed following local protocol in accordance with ISO 11607-1 or AAMI/CSR technique.

### Sterilization (USA)

- Autoclave should comply with the requirements of, and be validated and maintained in accordance with ANSI/AAMI ST79.
- Pre-Vacuum moist heat sterilization operating at temperature 132 °C bar for a minimum holding time of 4 minutes always following the instructions of the machine manufacturer.
- When sterilizing multiple instruments in one autoclave cycle, ensure that the sterilizer manufacturers stated maximum load is not exceeded.
- Ensure instruments are dry before sterilization.

### Sterilization (Outside USA)

- Autoclave should comply with the requirements of, and be validated and maintained in accordance with EN 285, EN 13060, EN ISO 17665.
- Either CE marked or validated vacuum autoclave operating at 134-137 °C bar for a minimum holding time of 3 minutes always following the instructions of the machine manufacturer.
- When sterilizing multiple instruments in one autoclave cycle, ensure that the sterilizer manufacturers stated maximum load is not exceeded.

### Storage

- Ensure instruments are dry before storage, and stored in dry, clean conditions at an ambient room temperature.

### Additional Information

- Other forms of cleaning (i.e. ultrasonic) and sterilization (i.e. Low temperature steam and Formaldehyde, Ethylene Oxide and Gas Plasma) are available. However, always follow the instructions for use as issued by the manufacturer and always consult with them if in any doubt over the suitability of any process used.
- Cleaning and sterilizing guidelines are available in HTM 2030 and HTM 2010. Contact: The NHS Estates Stationers Office Publications Cent for details at [www.tsonline.gov.uk](http://www.tsonline.gov.uk). For further information contact: NHS Estates Information Center, Department of Health, 1 Trevelyan Square, Boar Lane, Leeds, LS1 6AE, UK or visit [www.nhsestates.gov.uk](http://www.nhsestates.gov.uk).

**Note:** It is the responsibility of the re-processor to ensure that the reprocessing as actually performed using equipment, materials and personnel in the reprocessing facility achieve the desired result. This requires validation and routine monitoring of the process. Likewise any deviation by the re-processor from the instructions provided must be properly evaluated for effectiveness and potential adverse consequences.



## TABLE OF CONTENTS (A - Z)

Cannulas	32 - 42
Chisels & Gouges	170
Curettes & Spoons	43 - 44, 76
Fascia Needles, Cautery Balls	13
Fixation Rings	86 - 87
Forceps	127 - 166
Foreign Body Instruments	20 - 21
Haemostats & Bulldog Clamps	167
Hooks	85, 87 - 90, 182
Knives	15 - 28
Lens Loops	68 - 70
Markers	90 - 93
Mallet	82
Micro Manipulators	44 - 66, 70 - 74, 77 - 84
Needle Holders	171 - 181
Probes & Dilators	94 - 96, 183
Punches	30
Retractors, Lid Plates	10 - 14
Rongeurs	169, 183
Rulers & Calipers	94, 182
Scalpel Handles & Blades	97 - 98
Scissors	99 - 129
Scleral Markers & Depressors	11
Speculums	5 - 10
Sphere Introducers & Enucleation Instruments	75
Storing Cases	184
Towel Clamps	168
Trephines	29, 31
Ophthalmic Surgeries Sets	195-207



Eye Speculum  
Lidsperrer  
Blefarostatos  
Blépharostats  
Blefarostati

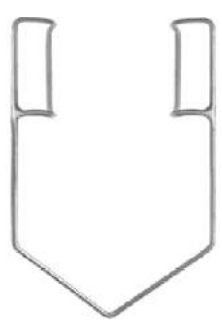

**Barraquer Wire Speculum**  
**67-010-10**  
Pediatric  
Wire Ø 0.9 mm  
Blade Size 10 mm

**67-010-15**  
Adult  
Wire Ø 0.9 mm  
Blade Size 15 mm

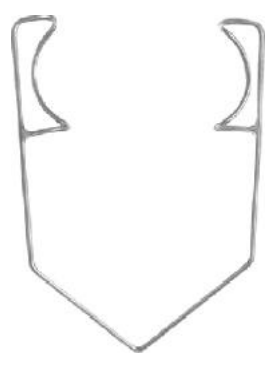

**67-012-15**  
**Barraquer Wire Speculum**  
Heavy Wire Ø 1.0 mm  
Blade Size 15 mm



**Barraquer Wire Speculum**  
(Solid Blades)

**67-020-10**  
Pediatric  
Blade Size 10 mm

**67-020-15**  
Adult  
Blade Size 15 mm



**67-022-20**  
**Feaster Wire Speculum**  
Solid Blades  
Blade Size 20 mm

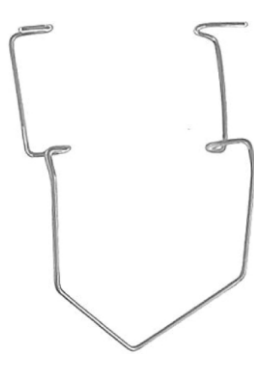

**Kratz-Barraquer Wire Speculum**

**67-030-13**  
With Open Blades, Wire Ø 0.9 mm  
Blade Size 13 mm

**67-030-15**  
With Open Blades, Wire Ø 0.9 mm  
Blade Size 15 mm

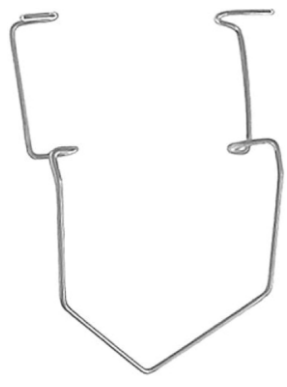

**67-032-15**  
**Kratz-Barraquer Wire Speculum**  
With open blades, Wire Ø 1.0 mm  
Blade Size 15 mm

Eye Speculum  
Lidsperrer  
Blefarostatos  
Blépharostats  
Blefarostati

OPHTHALMIC SURGERY INSTRUMENTS



**67-040-10**  
**Frankel Infant Lid Speculum**  
Adjustable Opening  
Blade Size 10 mm



**67-042-00**  
**Alfonso Infant Lid Speculum**  
With Finger Grip, Wire Ø 0.9 mm  
Blade Size 5 mm



**67-046-00**  
**Infant Lid Speculum**  
Wire Ø 0.9 mm  
Blade Size 4 mm



**67-050-09**  
**Barraquer Lid Speculum (Infant)**  
Wire Ø 0.9 mm  
Blade Size 9 mm



**Cook Eye Speculum**

**67-060-08**  
Infant  
Overall Length 52 mm, Blade Size 8 mm

**67-060-11**  
Pediatric  
Overall Length 55 mm, Blade Size 11 mm

**67-060-15**  
Adult  
Overall Length 55 mm, Blade Size 15 mm



Eye Speculum  
Lidsperrer  
Blefarostatos  
Blépharostats  
Blefarostati



**Murdoch Eye Speculum**

**67-064-12**

Overall Length 55 mm  
Blade Size 12 mm

**67-064-15**

Overall Length 57 mm  
Blade Size 15 mm



**67-070-15**

**Mellinger Eye Speculum**

Overall Length 57 mm  
Blade Size 15 mm



**67-072-02**

**Bangerter Eye Speculum**

Overall Length 55 mm With Locking Screw  
Blade Size 15 mm



**Williams Eye Speculum**

**67-074-11**

Overall Length 69 mm, With Locking Screw  
Blade Size 11 mm

**67-074-15**

Overall Length 86 mm, With Locking Screw  
Blade Size 15 mm

Eye Speculum  
Lidsperrer  
Blefarostatos  
Blépharostats  
Blefarostati

OPHTHALMIC SURGERY INSTRUMENTS



**67-076-16**  
**Lancaster Eye Speculum**  
Overall Length 69 mm, Adjustable Opening  
Blade Size 16 mm



**67-078-00**  
**Lester-Burch Eye Speculum**  
Overall Length 82 mm, Adjustable Opening  
Blade Size 21 mm

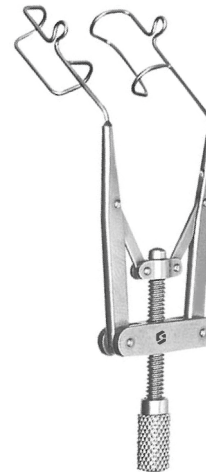

**67-081-15**  
**Tanna-Lieberman Eye Speculum**  
Overall Length 86 mm, Adjustable Opening  
Blade Size 15 mm



**Lieberman Eye Speculum**  
**67-083-10**  
Pediatric  
Overall Length 73 mm, Adjustable Opening  
Blade Size 10 mm



**67-083-15 A**  
**Lieberman Eye Speculum**  
With Aspirating Ports Overall Length 86 mm  
Adjustable Opening Blade Size 15 mm



**67-085-15**  
**Lieberman Eye Speculum**  
Overall Length 86 mm Adjustable Opening  
Blade Size 15 mm

**67-083-15**  
Adult  
Overall Length 86 mm, Adjustable Opening  
Blade Size 15 mm



Eye Speculum  
Lidsperrer  
Blefarostatos  
Blépharostats  
Blefarostati



**Lieberman Eye Speculum**  
(Solid Blades)

**67-087-10**

Pediatric  
Overall Length 73 mm, Adjustable Opening  
Blade Size 10 mm

**67-087-15**

Adult  
Overall Length 86 mm, Adjustable Opening  
Blade Size 15 mm



**67-089-15**

**Double X-K Wire Eye Speculum**

Overall Length 86 mm, Adjustable Opening  
Blade Size 15 mm



**67-089-15 A**

**Double X-K Wire Eye Speculum**

With Aspirating Ports Overall Length  
86 mm, Adjustable Opening  
Blade Size 15 mm



**Castroviejo Eye Speculum**

**67-091-14**

Overall Length 75 mm  
Adjustable Opening, 14 mm

**67-091-16**

Overall Length 82 mm  
Adjustable Opening, 16 mm



**67-095-04**

**Saunders Eye Speculum**

For Premature Infants Overall Length 35 mm  
With Locking Thumb Screw Blade Size 4 mm

Scleral Fixation Ring  
 Scleral Fixation Ring  
 Anillo de fijación escleral  
 Anneau de fixation scléral  
 Sclerale Fixation Anello

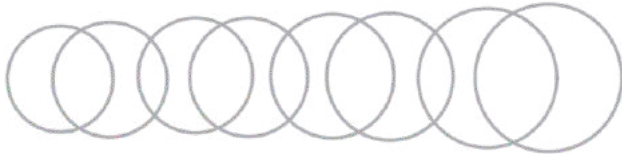
**67-100-00**
**Flieringa Scleral Fixation Ring**

Set of 9 From 67-100-14 up to 67-100-22



**67-100-14**  
14 mm

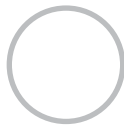

**67-100-15**  
15 mm

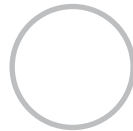

**67-100-16**  
16 mm

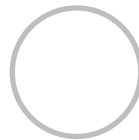

**67-100-17**  
17 mm

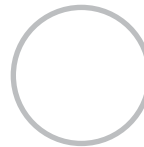

**67-100-18**  
18 mm

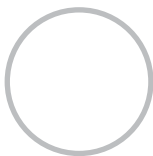

**67-100-19**  
19 mm

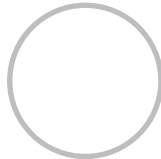

**67-100-20**  
20 mm

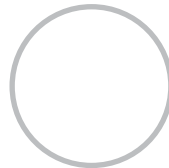

**67-100-21**  
21 mm

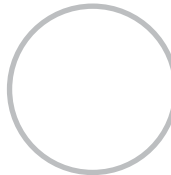

**67-100-22**  
22 mm

**McNeill-Goldman Scleral Fixation Ring**
**67-111-15**

Small, Ø 15 mm

**67-111-16**

Medium Ø 16 mm

**67-111-17**

Medium Ø 17 mm



Depressors, Eyelid Retractors  
 Depressors, Augenlid Wundhaken  
 Depresores, Retractor de párpados  
 Dépresseurs, Écarteur de paupières  
 Depressore, Palpebra Divaricatore



**67-151-01**  
**Gass Scleral Marker**  
 1.5 mm Marking Tip



**Schepens Scleral Depressor**

**67-153-01**  
 Tip Width 7 mm Thimble Ø 15 mm Tapered to Ø 13 mm

**67-153-02**  
 Tip Width 7 mm Thimble Ø 16 mm Tapered to Ø 14 mm

**67-153-03**  
 Tip Width 7 mm Thimble Ø 17 mm Tapered to Ø 15 mm



Teardrop Shaped  
 Tip of 2.5 mm

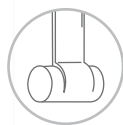

Bar Shaped  
 Tip 6 mm Wide

**67-160-14**  
**Schocket Scleral Depressor**  
 Double End With Clip  
 Overall Length 14 cm (5 1/2")



**67-163-00**  
**Gonnin Amsler Marker**  
 Measuring Range 7 - 23 mm With 1 mm  
 Increments  
 Overall Length 13 cm (5 1/4")



**67-171-15**  
**Schepens Orbital Retractor**  
 Blade Size 14 x 56 mm With 4.5 mm Wide Notch  
 Overall Length 15 cm (6")

Eyelid Retractors  
Augenlid Wundhaken  
Retractor de párpados  
Écarteur de paupières  
Palpebra Divaricatore



**Sauter Orbital Spatula**  
Overall Length 14 cm (5 ½")

**67-172-01**  
Blade Size 22 x 13 mm

**67-172-02**  
Blade Size 22 x 16 mm

**67-172-03**  
Blade Size 22 x 19 mm



**Jaffe Wire Lid Retractor (Pair)**

**67-173-13**  
Blade Width 13 mm

**67-173-15**  
Blade Width 15 mm



**Desmarres Lid Retractor**  
Overall Length 13 cm (5")



**67-175-11**  
Thin Solid Blades  
Fig. 0, 11 mm



**67-175-13**  
Thin Solid Blades  
Fig. 1, 13 mm



**67-175-15**  
Thin Solid Blades  
Fig. 2, 15 mm



**67-175-17**  
Thin Solid Blades  
Fig. 3, 17 mm



**Scleral Shield**  
**67-180-01**  
20 x 28 mm, Small (Pair)



**67-180-02**  
22 x 30 mm, Large (Pair)

Eyelid Retractors  
Augenlid Wundhaken  
Retractor de párpados  
Écarteur de paupières  
Palpebra Divaricatore



**67-192-11**  
**Jaeger Lid Plate**  
20 x 35 / 24 x 35  
Overall Length 11 cm (4 1/4")



**67-197-14**  
**Wright Fascia Needle**  
Oval Hole, 1 x 6 mm  
Overall Length 14 cm (5 1/2")



**67-199-14**  
**Wills Cautery**  
With Copper Ball Ø 12 mm  
Overall Length 14 cm (5 1/2")



**67-201-12**  
**Walton Conjunctiva Retractor**  
Thin Solid Blade, 6 mm  
Overall Length 12.5 cm (5")



**Helveston Tissue Retractor**  
Thin Curved Blade  
Overall Length 12.5 cm (5")



**67-211-07**  
"Barbie"  
Blade Width 7 mm



**67-211-09**  
"Big Barbie"  
Blade Width 9 mm



**67-211-11**  
"Great Big Barbie"  
Blade Width 11 mm

Eyelid Retractors  
Augenlid Wundhaken  
Retractor de párpados  
Écarteur de paupières  
Palpebra Divaricatore



**67-220-00**  
**Stevenson Lacrimal Sac Retractor**  
3 x 3 Blunt Prongs, Adjustable Opening  
Overall Length 85 mm



**67-222-00**  
**Stevenson Lacrimal Sac Retractor**  
Solid Blades With Serrated Edge Adjustable  
Opening Blade Size 13 mm  
Overall Length 85 mm



**67-226-00**  
**Agricola Lacrimal Sac Retractor**  
3 x 3 Blunt Prongs  
Overall Length 14 mm

9  
220  
210  
8  
200  
190  
7  
180  
170  
6  
160  
150  
5  
140  
130  
4  
120  
110  
3  
100  
90  
80  
3  
70  
60  
2  
50  
40  
1  
30  
20  
10  
INCHES  
MILLIMETERS

Keratome  
Keratome  
Queratomos  
Kératotomes  
Cheratomy



**Dastoor Gouge & Lacrimal Sac Dissector**  
Overall Length 13 cm (5 1/4")

**67-228-01**

With Sharp Gouge and Sharp Dissector

**67-228-02**

With Sharp Gouge and Blunt Dissector



**Bonn Scleral Knife**

Rounded Tip  
Overall Length 12 cm (4 3/4")

**67-239-40**

Angled, 4 mm Wide Tip

**67-239-70**

Angled, 7 mm Wide Tip



**Jaeger Keratome**  
Overall Length 13 cm (5")

**67-240-01**

Straight, Fig. 1  
8.0 mm x 9.5 mm

**67-240-02**

Straight, Fig. 2  
9.5 mm x 11.0 mm

**67-240-03**

Straight, Fig. 3  
11.0 mm x 12.5 mm

**67-241-01**

Angled, Fig. 1  
8.0 mm x 9.5 mm

**67-241-02**

Angled, Fig. 2  
9.5 mm x 11.0 mm

**67-241-03**

Angled, Fig. 3  
11.0 mm x 12.5 mm

Corneal Knives  
 Hornhaut-Messer  
 Cuchillos corneales  
 Couteaux corneé  
 Coltelli corneali



**67-250-11**  
**Tooke Corneal Knife**  
 Straight, Blade Size 3 x 18 mm Smooth Blade  
 Overall Length 11 cm (4 1/4")



**67-251-01**  
 Fig. 1, Blade Size 5.5 mm x 2.5 mm

**67-251-02**  
 Fig. 2, Blade Size 4.5 mm x 2.0 mm

**Kuhnt Corneal Scarifier**  
 Overall Length 11 cm (4 1/4")

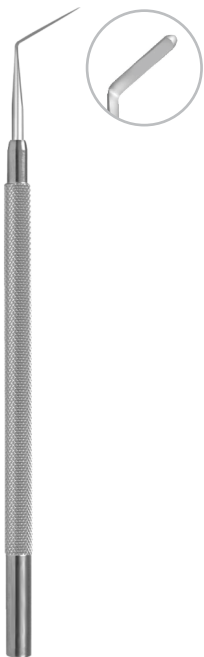

**67-253-12**  
**DLEK Corneal Dissector**  
 12 mm Long x 3 mm Wide With Semi-Sharp Spatulated Tip  
 Overall Length 12 cm (4 3/4")

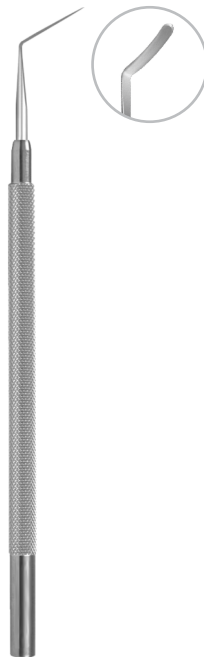

**67-255-12**  
**DLEK Corneal Dissector**  
 12 mm Long x 3 mm Wide With Semi-Sharp Spatulated Tip  
 Overall Length 12 cm (4 3/4")



Corneal Knives  
Hornhaut-Messer  
Cuchillos corneales  
Couteaux cornée  
Coltelli corneali



**67-256-01**

Fig. 1, 1.5 x 25 mm



**67-256-02**

Fig. 2, 1.7 x 27 mm

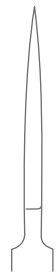

**67-256-03**

Fig. 3, 2 x 30 mm



**67-256-04**

Fig. 4, 2.3 x 33 mm



**67-256-05**

Fig. 1, 2.5 x 35 mm

**Graefe Cataract Knife**

Straight Blade and With Sharp Cutting Edge  
Overall Length 12 cm (4 3/4")



**67-257-05**

Fig. 1, 5 mm

**67-257-06**

Fig. 2, 6 mm

**67-257-07**

Fig. 3, 7 mm

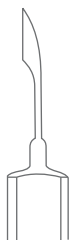

**Walter Cataract Needle**

Overall Length 12 cm (4 3/4")



**67-258-12**

Straight, Blade Size 2.4 mm  
Wide x 4.5 mm Long Blade



**67-259-12**

Curved, Blade Size 2.4 mm  
Wide x 4.5 mm Long Blade

**Ziegler Iris Knife**

Overall Length 12 cm (4 3/4")

Corneal Knives  
Hornhaut-Messer  
Cuchillos corneales  
Couteaux cornée  
Coitelli corneali



**67-260-12**

**Gills Corneal Knife**

Straight, Rounded Cutting Edge Blade Size 3 mm  
Overall Length 12.5 cm (5")



**67-261-12**

**Gills Corneal Knife**

Slightly Curved, Rounded Cutting Edge Blade Size 3 mm  
Overall Length 12.5 cm (5")

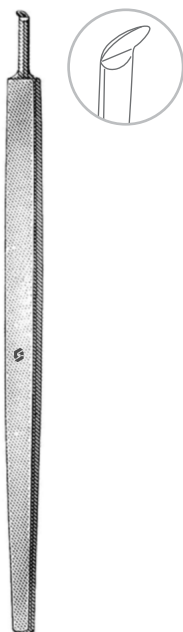

**67-263-12**

**Paufigue Graft Knife**

Blade Size 1.6 mm x 1.75 mm Angled Cutting Edge  
Overall Length 12 cm (4 3/4")



**67-265-12**

**Fukasaku Hockey Knife**

3 mm Sharp Front Edge 6 mm Semi Sharp Bottom Edge  
Overall Length 12 cm (4 3/4")



Corneal Knives  
Hornhaut-Messer  
Cuchillos corneales  
Couteaux cornée  
Coltelli corneali



**67-266-11**  
**Barkan Goniotomy Knife**  
Blade Size 2.5 mm Long Blade  
Overall Length 11.5 cm (4 1/2")



**67-268-01**  
**Micro Round Viscocanalostomy Knife**  
1.0 mm Rounded Sharp Cutting Edge  
Overall Length 11.5 cm (4 1/2")

Gouges and Spuds  
Hohlmeißel und Meißel  
Gubias para Cinceles  
Gouges et Ciseaux-burins  
Sgorbie e Scalpelli



**67-271-12**

**Golf Club Foreign Body Spud**

Blade Size 2 x 0.8 mm Small Golf Club Shaped Tip  
With Sharp Edge  
Overall Length 12 cm (4 3/4")



**67-273-12**

**Francis Foreign Body Spud**

Blade Size 2 x 0.8 mm Flag Shaped Tip With Sharp Edge  
Overall Length 12 cm (4 3/4")



**67-275-11**

**Ellis Foreign Body Spud**

Light Curved 1.0 mm Rounded Tip  
Overall Length 11 cm (4 1/4")



**67-276-12**

**Walton Foreign Body Gouge**

1.4 mm Rounded Tip  
Overall Length 12.5 cm (5")

Gouges and Spuds  
 Hohlmeißel und meißel  
 Gubias para Cinceles  
 Gouges et Ciseaux-burins  
 Sgorbie e Scalpelli

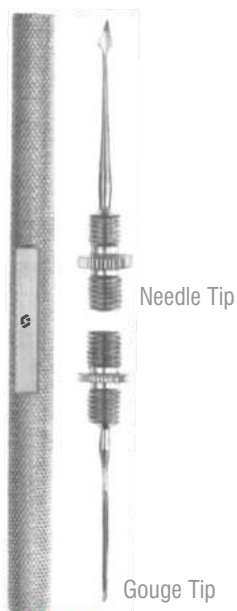

**67-280-18**  
**Dix Foreign Spud & Gouge**  
 3 X 5 mm Needle Tip On One Side 1.7 X 15 mm  
 Gouge Tip On Other Side In Reversible Handle  
 Overall Length 18 cm (7")



**67-283-11**  
**Wills Eye Hospital Foreign Body Spud & Burr**  
 Delicate Curved  
 11 cm (4 1/4")



**67-285-00**  
**Arruga Micro Burr**  
 1.0 mm Round Burr  
 Overall Length 12 cm (4 3/4")



**67-291-11**  
**Foreign Body Eye Magnet and Loop**  
 Overall Length 11 cm (4 1/4")

Diamond Knives  
 Diamantmesser  
 Bisturi de diamante  
 Couteaux de diamant  
 Coltelli di diamanti



**67-300-12**  
 6-Facet Blade for Bi-directional Cutting Pre-calibrated Depth Settings of 0.6 mm

**LRI Diamond Step Knife**  
 Overall Length 12 cm (4 3/4")



**67-302-12**  
 6-Facet Blade for Bi-directional Cutting Pre-calibrated Depth Settings of 0.5 mm, 0.55 mm and 0.6 mm

**LRI Diamond Micrometer Knife**  
 Overall Length 12 cm (4 3/4")



**67-304-12**  
 6-Facet Blade for Bi-directional Cutting 0 to 1.5 mm Blade Extension in 10 Micron Increments

**LRI Diamond Micrometer Knife**  
 Overall Length 12 cm (4 3/4")



Diamond Knives  
 Diamantmesser  
 Bisturi de diamante  
 Couteaux de diamant  
 Coltelli di diamanti

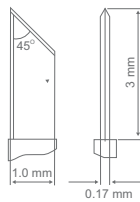

**67-305-11**  
 Double Vertical and 45° Cutting Edge Each Depth Can Be Adjusted Without Steps The Scale is Divided Each Hundredth Millimeter

**AK Diamond Knife**  
 Overall Length 11 cm (4 1/4")

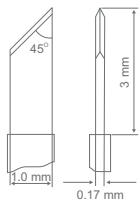

**67-311-01**  
 Single 1 mm Wide 45° Cutting Edge Each Depth Can Be Adjusted Without Steps The Scale is Divided Each Hundredth Millimeter

**Diamond Micrometer Knife**  
 Overall Length 13 cm (5")

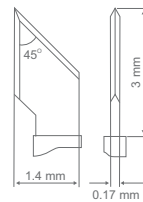

**67-311-02**  
 Double Vertical and 45° Cutting Edge Each Depth Can Be Adjusted Without Steps The Scale is Divided Each Hundredth Millimeter

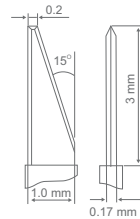

**67-311-03**  
 Triple Vertical and 15° Cutting Edge Each Depth Can Be Adjusted Without Steps The Scale is Divided Each Hundredth Millimeter



Diamond Knives  
 Diamantmesser  
 Bisturi de diamante  
 Couteaux de diamant  
 Coltelli di diamanti

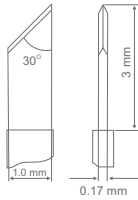

**67-316-01**  
 Single 1 mm Wide  
 30° Cutting Edge

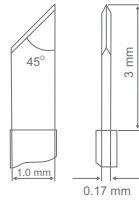

**67-316-02**  
 Single 1 mm Wide  
 45° Cutting Edge

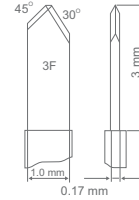

**67-316-03**  
 Single 1 mm Wide  
 Tri-Facet Cutting Edge

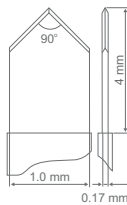

**67-316-04**  
 1 mm Wide Spear  
 Shaped Cutting Edge

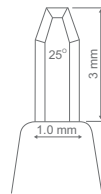

**67-316-05**  
 1 mm Wide  
 10-Facet Cutting Edge

**Diamond Knife**  
 Overall Length 12.5 cm (5")







Diamond Knives  
 Diamantmesser  
 Bisturi de diamante  
 Couteaux de diamant  
 Coltelli di diamanti

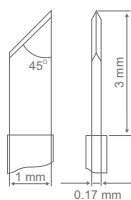

**67-320-01**  
 Single 45° Cutting Edge 1.0 mm Wide  
 With Adjustable Cutting  
 Depth of 0 / 0.3 / 0.4 / 0.5 / 0.6 /  
 0.8 / 1.0 / 2.5 mm

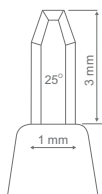

**67-320-03**  
 10-Facet Cutting Edge 1.0 mm Wide  
 With Adjustable Cutting  
 Depth of 0.15 / 0.2 / 0.25 / 0.3 /  
 0.37 / 0.5 / 4.0 mm

**Diamond Step Knife**  
 Overall Length 12.5 cm (5")

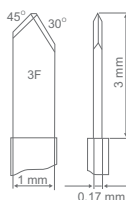

**67-320-02**  
 Trifacet Cutting Edge 1.0 mm Wide  
 With Adjustable Cutting  
 Depth of 0 / 0.3 / 0.4 / 0.5 / 0.6 /  
 0.8 / 1.0 / 2.5 mm

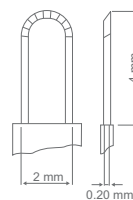

**67-331-25**  
 Crescent Shaped 9-Edge  
 Vertical Blade 2.0 mm Wide  
 Angled

**Crescent Diamond Knife**  
 Overall Length 11.5 cm (4 1/2")

Diamond Knives  
 Diamantmesser  
 Bisturi de diamante  
 Couteaux de diamant  
 Coltelli di diamanti

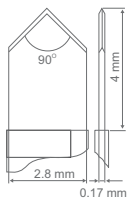

**67-340-28**  
 Straight, 2.8 mm  
 Spear Shaped Cutting  
 Edge

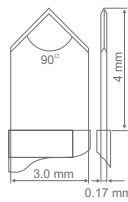

**67-340-30**  
 Straight, 3.0 mm  
 Spear Shaped Cutting  
 Edge

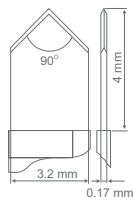

**67-340-32**  
 Straight, 3.2 mm  
 Spear Shaped Cutting  
 Edge

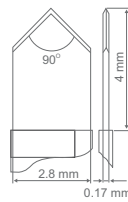

**67-341-28**  
 Angled, 2.8 mm  
 Spear Shaped Cutting  
 Edge

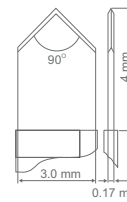

**67-341-30**  
 Angled, 3.0 mm  
 Spear Shaped Cutting  
 Edge

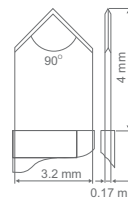

**67-341-32**  
 Angled, 3.2 mm  
 Spear Shaped Cutting  
 Edge

**Diamond Phaco Knife**  
 Straight, Spear Shaped  
 Overall Length 13 cm (5")

**Diamond Phaco Knife**  
 Angled, Spear Shaped  
 Overall Length 13 cm (5")





Diamond Knives  
 Diamantmesser  
 Bisturi de diamante  
 Couteaux de diamant  
 Coltelli di diamanti



**Diamond Phaco Knife**  
 Overall Length 13 cm (5")

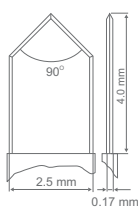

**67-351-25**  
 Angled, 2.5 mm  
 Spear Shaped 4 - Sided  
 Cutting Edge

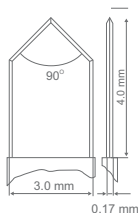

**67-351-30**  
 Angled, 3.0 mm  
 Spear Shaped 4 - Sided  
 Cutting Edge

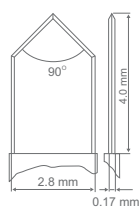

**67-351-28**  
 Angled, 2.8 mm  
 Spear Shaped 4 - Sided  
 Cutting Edge

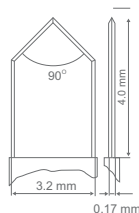

**67-351-32**  
 Angled, 3.2 mm  
 Spear Shaped 4 - Sided  
 Cutting Edge



**Diamond Phaco Knife**  
 Overall Length 12 cm (4 3/4")

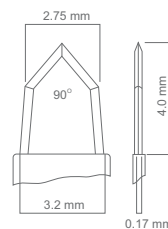

**67-355-27**  
 Angled, 2.75 / 3.2 mm Trapezoid  
 Shaped 4 - Sided Cutting Edge



Diamond Knives  
 Diamantmesser  
 Bisturi de diamante  
 Couteaux de diamant  
 Coltelli di diamanti

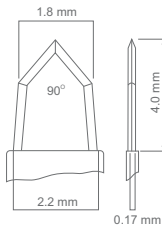

**67-357-18**

Angled, 1.8 / 2.2 mm Trapezoid Shaped 4 - Sided Cutting Edge

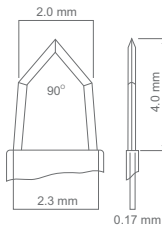

**67-357-20**

Angled, 2.0 / 2.3 mm Trapezoid Shaped 4 - Sided Cutting Edge

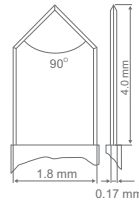

**67-359-18**

Angled, 1.8 mm Spear Shaped 4 - Sided Cutting Edge

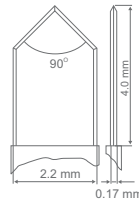

**67-359-22**

Angled, 2.2 mm Spear Shaped 4 - Sided Cutting Edge

**MICS Diamond Knife**  
 Overall Length 12 cm (4 3/4")

**MICS Diamond Knife**  
 Overall Length 13 cm (5")



Trephines  
Trephinen  
Trépanos  
Tréfans  
Trepani



**67-370-10**  
Ø 1.0 mm

**67-370-15**  
Ø 1.5 mm

**67-370-20**  
Ø 2.0 mm

**Elliot Scleral Trephine Blade**  
3.5 cm (1 1/2")



**67-370-90**  
**Elliot Trephine Handle**  
4.5 cm (1 3/4")



**67-381-08**  
Ø 8 mm

**67-381-09**  
Ø 9 mm

**67-381-10**  
Ø 10 mm

**Camellin LASEK Trephine**  
270° Semi-Sharp Edge 90° Cut Out for Flap Hinge  
Overall Length 12 cm (4 3/4")



**67-385-08**  
Ø 8 mm Trephine and Ø 8.5 mm Well

**67-385-09**  
Ø 9 mm Trephine and Ø 9.5 mm Well

**67-385-10**  
Ø 10 mm Trephine and Ø 10.5 mm Well

**Camellin LASEK Trephine & Alcohol Retaining Well**  
Overall Length 12.5 cm (5")

Ophthalmic Punches  
 Augenheilkunde Stanze  
 Punzones de oftalmologia  
 Poinçons ophtalmiques  
 Punzoni oftalmici



**67-391-00**

**Gass Corneoscleral Punch**

With 360° Rotatable Cutting Tip 1.5 mm x 0.75 mm Bite  
 Overall Length 8.5 cm (3 1/2")



**67-395-00**

**Luntz-Dodick Trabeculectomy Punch**

With 360° Rotatable Cutting Tip 1 mm x 0.5 mm Bite  
 Overall Length 11.5 cm (4 1/2")



**67-397-00**

**Kelly Descemet's Membrane Punch**

For Glaucoma 19 Gauge / 1.0 mm 0.9 mm x 0.45 mm Bite  
 Overall Length 12.5 cm (5")



**67-399-00**

**Christensen Punctum Punch**

For Opening Stenotic Punctum 1.0 mm Wide Tip  
 Overall Length 10 cm (4")

Trephines  
 Trephinen  
 Trépanos  
 Tréfans  
 Trepani



**Corneal Trephine Blade**

<b><u>67-400-01</u></b> Ø 6.0 mm	<b><u>67-400-02</u></b> Ø 6.5 mm	<b><u>67-400-03</u></b> Ø 6.75 mm	<b><u>67-400-04</u></b> Ø 7.0 mm	<b><u>67-400-05</u></b> Ø 7.25 mm	<b><u>67-400-06</u></b> Ø 7.5 mm	<b><u>67-400-07</u></b> Ø 7.75 mm	<b><u>67-400-08</u></b> Ø 8.0 mm
<b><u>67-400-09</u></b> Ø 8.25 mm	<b><u>67-400-10</u></b> Ø 8.5 mm	<b><u>67-400-11</u></b> Ø 8.75 mm	<b><u>67-400-12</u></b> Ø 9.0 mm	<b><u>67-400-13</u></b> Ø 9.5 mm	<b><u>67-400-14</u></b> Ø 14.0 mm		



**Corneal Trephine Handle**

<b><u>67-401-01</u></b> Ø 6.0 mm	<b><u>67-401-02</u></b> Ø 6.5 mm	<b><u>67-401-03</u></b> Ø 6.75 mm	<b><u>67-401-04</u></b> Ø 7.0 mm	<b><u>67-401-05</u></b> Ø 7.25 mm	<b><u>67-401-06</u></b> Ø 7.5 mm	<b><u>67-401-07</u></b> Ø 7.75 mm	<b><u>67-401-08</u></b> Ø 8.0 mm
<b><u>67-401-09</u></b> Ø 8.25 mm	<b><u>67-401-10</u></b> Ø 8.5 mm	<b><u>67-401-11</u></b> Ø 8.75 mm	<b><u>67-401-12</u></b> Ø 9.0 mm	<b><u>67-401-13</u></b> Ø 9.5 mm			



Cannulas  
 Kanülen  
 Cánulas  
 Canules  
 Cannule

**Lacrimal Cannula**
**67-410-23**

 Malleable Tip  
 Straight, 23 G

**67-410-27**

 Malleable Tip  
 Straight, 27 G

**Lacrimal Cannula**
**67-411-23**

 Malleable Tip  
 Curved, 23 G

**67-411-27**

 Malleable Tip  
 Curved, 27 G

**67-412-23**  
**McIntyre Lacrimal**  
**Cannula**

 Straight, 23 G,  
 Blunt Tip Dual  
 0.3 mm Side Ports

**67-413-23**  
**McIntyre Lacrimal**  
**Cannula**

 Curved, 23 G,  
 Blunt Tip Dual  
 0.3 mm Side Ports

**67-415-23**  
**West Lacrimal Cannula**

 Blunt Tip, 23 G  
 0.3 mm Side Port

**67-417-27**  
**DALK Air Injection**  
**Cannula**

 Flattened, Vaulted  
 0.2 mm Posterior Port  
 Near Tip, 27 G

**67-419-27**  
**Rosenwasser DALK Cannula**

 Flattened "Cobra Shaped"  
 Tip 0.2 mm Posterior Port  
 27 G

Top View

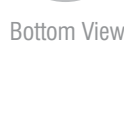

Bottom View

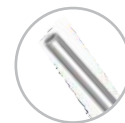
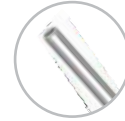
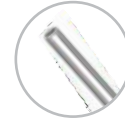

**Air Injection Cannula**

**67-421-27**  
 Angled at  
 5 mm, 27 G

**67-421-30**  
 Angled at  
 5 mm, 30 G

**67-423-27**  
 Angled at  
 7 mm, 27 G

**67-423-30**  
 Angled at  
 7 mm, 30 G



Cannulas  
Kanülen  
Cánulas  
Canules  
Cannule



**67-427-19**  
19 G





**67-427-21**  
21 G



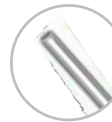

**67-429-19**  
10 mm, 19 G



**67-429-22**  
10 mm, 22 G

**67-433-25**  
**Troutman Olive Tip Cannula**  
Delicate, 25 G

**67-437-27**  
Flat Tip, Angled at 7 mm  
27 G



**67-437-30**  
Flat Tip, Angled at 7 mm  
30 G

Cannulas  
Kanülen  
Cánulas  
Canules  
Cannule



**67-439-25**  
**LASEK Alcohol Cannula**  
Angled at 10 mm  
Delicate Olive Shaped Tip, 25 G



**67-441-19**  
**Stevens Sub Tenon's Anesthesia Cannula**  
Gently Curved, Flat Tip, 19 G



**67-443-23**  
**Atkinson Retrobulbar Needle**  
Straight, 35 mm Long Sharp Tip 23 G



**67-445-23**  
**Corbin Sub Tenon's Anesthesia Cannula**  
Smooth Rounded Tip With 0.3 mm  
Side Port 23 G



**67-447-24**  
**Fukasaku Sub Tenon's Anesthesia Cannula**  
Gently Curved Smooth Tip, 24 G

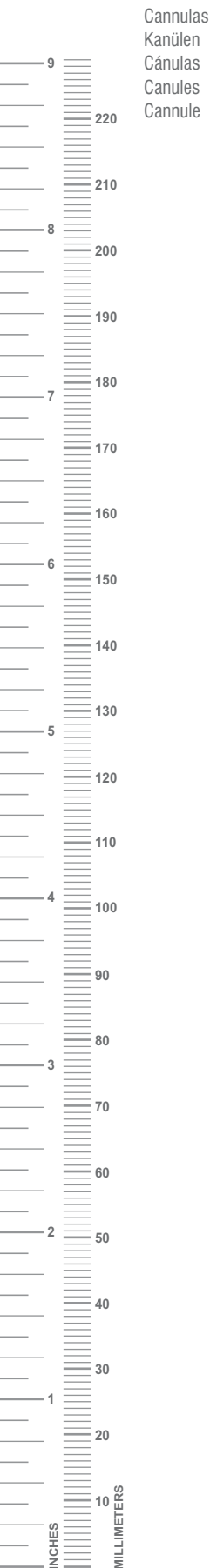

Cannulas  
 Kanülen  
 Cánulas  
 Canules  
 Cannule

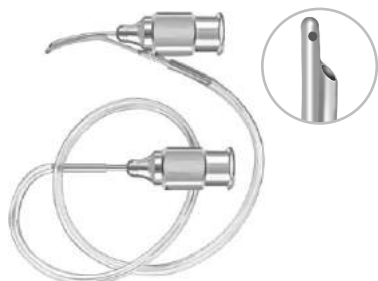

**67-451-23**  
**Simcoe Irrigating - Aspirating Cannula**  
 15 mm Long With 0.3 mm Aspirating Side Port, 23 G  
 Aspiration Through Tubing Hub and Irrigation Through  
 Luer-Lock Hub

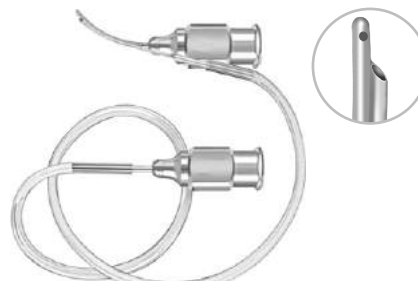

**67-453-23**  
**Simcoe (Reversed) Irrigating - Aspirating Cannula**  
 15 mm Long With 0.3 mm Aspirating Side Port, 23 G  
 Aspiration Through Luer-Lock Hub and Irrigation Through  
 Tubing Hub



**67-455-23**  
**Simcoe Irrigating - Aspirating Cannula**  
 Curved Right, 23 G  
 U-Shaped, With 0.3 mm Anterior Aspiration Port  
 Aspiration Through Tubing Hub and Irrigation  
 Through Luer-Lock Hub



**67-457-23**  
**Simcoe Irrigating - Aspirating Cannula**  
 Curved Left, 23 G  
 U-Shaped, With 0.3 mm Anterior Aspiration Port  
 Aspiration Through Tubing Hub and Irrigation  
 Through Luer-Lock Hub

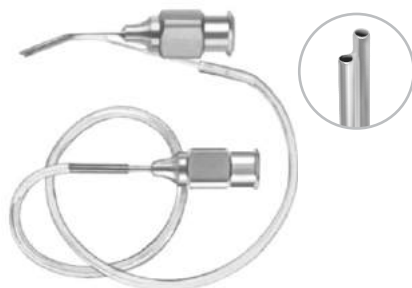

**67-459-23**  
**Gills Irrigating - Aspirating Cannula**  
 23 G, Angled Tip, Front Openings  
 With 0.5 mm Recessed Irrigating Port



**67-462-22**  
**Kelman Cystotome**  
 23 G, Sharp Cutting Edge With Sharp Point

Cannulas  
Kanülen  
Cánulas  
Canules  
Cannule



**67-463-22**

**Kraitz Cystotome**

22 G, Sharp Cutting Edge With Sharp Point



**67-465-23**

**McIntyre Cystotome**

23 G, Angled at 10 mm, Sharp Point



**Jansen Capsule Polisher Cannula**

**67-467-23**

23 G, Gently Curved Shaft With Lower Half Diamond Dusted Olive Tip

**67-467-25**

25 G, Gently Curved Shaft With Lower Half Diamond Dusted Olive Tip



**67-471-19**

**Bishop-Harmon Anterior Chamber Irrigator**

23 G, Angled Shaft With Flat Blunt Tip Including Adapter and Blue Silicone Bulb



**67-475-25**

**Hydrodissection Cannula**

Angled at 8 mm, Flat Tip, 25 G



**67-477-26**

**Seeley Hydrodissection Cannula**

Angled at 12 mm, Flat Tip, 25 G

Cannulas  
Kanülen  
Cánulas  
Canules  
Cannule



**67-481-23**  
23 G

**67-481-27**  
27 G

**67-481-30**  
30 G

**Knolle Anterior Chamber Irrigation Cannula**  
Angled at 2 mm With Front Opening Tip



**67-485-27**  
**Sauter Hydrodissection Cannula**  
Vertically Flattened Tip With Front Opening, 27 G



**67-487-19**  
**Bracken Irrigation Cannula**  
Smooth Beveled Tip With Front Opening, 19 G



**67-489-23**  
**Irrigation Cannula**  
Curved Shaft With Blunt Tip and Dual 0.4 mm Side Ports, 23 G



**67-491-23**  
**Alio LASIK Irrigation Cannula**  
With One Front and Two Side Ports, 23 G



**67-493-21**  
**Irrigation Cannula**  
Curved Shaft With Blunt Tip and Dual 0.5 mm Side Ports, 21 G

Cannulas  
Kanülen  
Cánulas  
Canules  
Cannule



**67-495-26**

**Spatulated LASIK Cannula**

Flattened Spatula Shaped Tip, 26 G



**67-501-23**

**Fukasaku LASIK Cannula**

Flattened Low Profile Tip With  
Front Opening, 23 G



**67-503-25**

**Carter LASIK Cannula**

Flattened Low Profile Tip With  
Front Opening, 25 G





**67-507-25**

**Banaji LASIK Cannula**

6 Irrigating Ports With Bullet Shaped Tip, 25 G

Cannulas  
 Kanülen  
 Cánulas  
 Canules  
 Cannule







**67-509-23**  
23 G

**67-509-25**  
25 G

**Buratto LASIK Cannula**  
Slightly Flattened Tip With One Front and Two Side Ports



**67-511-25**  
**Brierley LASIK Cannula**  
6 Irrigating Ports With Closed Spatula Shaped Tip, 25 G



**67-516-23**  
23 G

**67-516-26**  
26 G

**67-516-30**  
30 G

**McIntyre Anterior Chamber Cannula**  
Straight, Smooth Blunt Tip With Front Opening



**67-517-23**  
23 G

**67-517-26**  
26 G

**67-517-30**  
30 G

**McIntyre Anterior Chamber Cannula**  
Angled, Smooth Blunt Tip With Front Opening



**67-519-30**  
**Gimbel Cortex Aspirating Cannula**  
Double Angled With Round Front Opening Tip, 30 G



**67-521-23**  
**Simcoe Cortex Extractor**  
13 mm Curved Shaft With 0.3 mm Side Port, 23 G



**67-523-23**  
**Simcoe Cortex Extractor**  
21 mm Curved Shaft With 0.4 mm Side Port, 23 G



**67-525-21**  
**Simcoe Cortex Extractor**  
Smooth Closed Tip 21 mm Long Side Port, 23 G

Cannulas  
Kanülen  
Cánulas  
Canules  
Cannule



**67-527-23**  
**Charleux Cortex Extractor**  
Curved Shaft With Beveled Irrigation Port 23 G

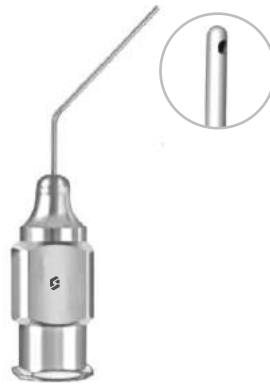

**67-527-25**  
**De La O Aspirating Cannula**  
Angled at 12 mm With 0.3 mm Side Port, 25 G



**Gills Aspirating Cannula**  
Angled Shaft With Smooth Blunt Round Tip, 25 G



**67-529-05**  
5 mm Long Tip



**67-529-07**  
7 mm Long Tip

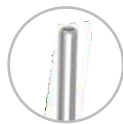

**67-529-08**  
8 mm Long Tip

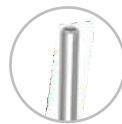

**67-529-10**  
10 mm Long Tip



**67-531-23**  
**Fukasaku Hydro-Chop Cannula**  
Vertically Flattened Tip, Dual Side Ports, 23 G



**67-532-27**  
**Chang Hydrodissection Cannula**  
Flat Tip With Beveled Opening, 27 G



**67-533-23**  
**Drews Irrigation Vectis**  
One Front and Two Backward Opening Ports, 23 G



**67-535-20**  
**Sheets Irrigation Vectis**  
Three Front Opening Ports, 20 G





Cannulas  
Kanülen  
Cánulas  
Canules  
Cannule



**67-537-23**  
**Knolle-Pearce Irrigation Vectis**  
Three Front Opening Ports, 23 G



**67-539-25**  
**Simcoe Irrigation Lens Nucleus Loop**  
Finely Serrated Tip With Two Front Opening Ports, Right, 25 G



**67-541-25**  
**Simcoe Irrigation Lens Nucleus Loop**  
Finely Serrated Tip With Two Front Opening Ports, Left, 25 G



**Alfonso Nucleus Irrigating Spoon**  
**67-542-25**  
2.5 mm Wide Spoon With Single 0.3 mm Front Opening Port

**67-542-40**  
4.0 mm Wide Spoon With Single 0.3 mm Front Opening Port

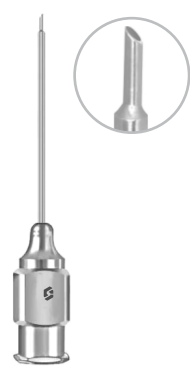

**67-543-22**  
**Drof Infusion Cannula**  
18 Gauge Shaft With 22 Gauge 3 mm Long Tip

Cannulas  
Kanülen  
Cánulas  
Canules  
Cannule



**Heslin Infusion Cannula**  
Texture Tip



**67-545-23**  
23 G



**67-545-25**  
25 G



**67-547-22**  
**Infusion Cannula**  
Self Retaining Tip  
22 G



**67-549-01 T**  
**Irrigation Handpiece**  
Titanium  
For Bimanual Technique, 21 G, Dual 2 x 0.5 mm Side Ports  
Overall Length 10.5 cm (4")



**67-549-02 T**  
**Aspiration Handpiece**  
Titanium  
For Bimanual Technique, 21 G, 2 x 0.5 mm Side Port  
Overall Length 10.5 cm (4")



Ophthalmology Instruments  
 Ophthalmologie Instrumente  
 Oftalmología Instrumentos  
 Ophthalmologie Instrumente  
 Oftalmologia Strumenti



**67-550-00**  
 Fig. 0, Ø 1.5 mm



**67-550-01**  
 Fig. 1 Ø 1.75 mm



**67-550-02**  
 Fig. 2, Ø 2.25 mm



**67-550-03**  
 Fig. 3, Ø 2.5 mm



**67-550-04**  
 Fig. 4, Ø 3.5 mm



**Meyerhoefer Chalazion Curette**  
 Overall Length 12.5 cm (5")



**67-552-10**  
 Fig. 0  
 1 x 1.7 mm



**67-552-15**  
 Fig. 1  
 1.5 x 2.5 mm



**67-552-20**  
 Fig. 2  
 2.0 x 3.3 mm



**67-552-25**  
 Fig. 3  
 2.5 x 4.0 mm



**67-552-30**  
 Fig. 4  
 3.0 x 5.0 mm



**67-552-35**  
 Fig. 5  
 3.5 x 5.7 mm



**Hebra Chalazion Curette**  
 Overall Length 12.5 cm (5")

Ophthalmology Instruments  
 Ophthalmologie Instrumente  
 Oftalmologia Instrumentos  
 Ophthalmologie Instruments  
 Oftalmologia Strumenti



**67-571-12**  
**Nightingale Capsule Polishing Curette**  
 Semi-Sharp Posterior Edge Ø 1.75 mm Open Ring  
 Overall Length 12.5 cm (5")



**67-573-12**  
**Shepherd Capsule Polishing Curette**  
 Semi-Sharp Anterior & Posterior Edges Ø 1.75 mm Open Ring  
 Overall Length 12.5 cm (5")



**67-587-13**  
**Blumenthal Conjunctiva Dissector**  
 Ø 2.0 mm Blunt Disc Shaped Tip  
 Overall Length 13 cm (5")



**67-591-12**  
**Buratto LASIK Flap Protector**  
 12.0 mm Wide Blade  
 Overall Length 12.5 cm (5")



Ophthalmology Instruments  
 Ophthalmologie Instrumente  
 Oftalmología Instrumentos  
 Ophthalmologie Instrumente  
 Oftalmologia Strumenti



**67-594-11**  
**Buratto LASIK Flap Protector**  
 Double Ended With 12.0 mm Wide Blades Angled at 15°  
 Overall Length 11.5 cm (4 1/2")



**67-597-11**  
**Mannis-Buratto LASIK Flap Protector**  
 Double Ended With 12.0 mm Wide Blades Angled at 45°  
 Overall Length 11.5 cm (4 1/2")

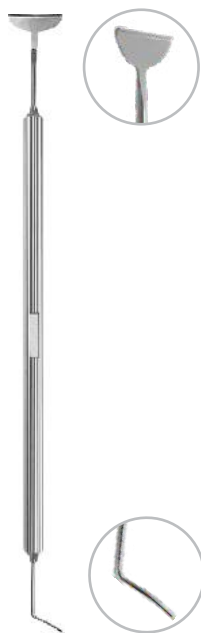

**67-599-13**  
**Rowen LASIK Flap Protector/Spatula**  
 12.0 mm Wide Protector Blade and 8.0 mm Long Spatula Blade  
 Overall Length 13 cm (5")

Ophthalmology Instruments  
 Ophthalmologie Instrumente  
 Oftalmologia Instrumentos  
 Ophthalmologie Instruments  
 Oftalmologia Strumenti

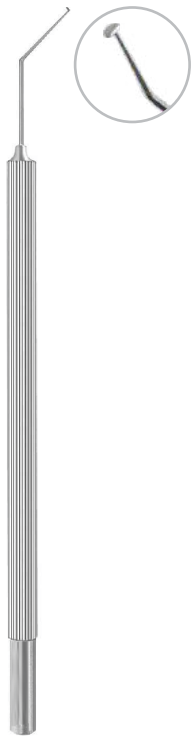

**67-611-12**  
**Sloane LASIK Micro Hoe**  
 2.0 mm Wide Semi-Circular  
 Tip With Beveled Edges  
 Overall Length 12 cm (4 ¾")

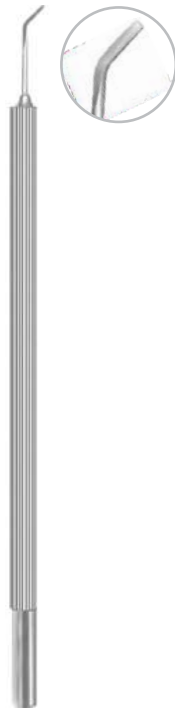

**67-615-11**  
**Sloane Epi Peeler**  
 1 x 5 mm Spatula Shaped  
 Semi Sharp Tip Edge  
 Overall Length 11.5 cm (4 ½")

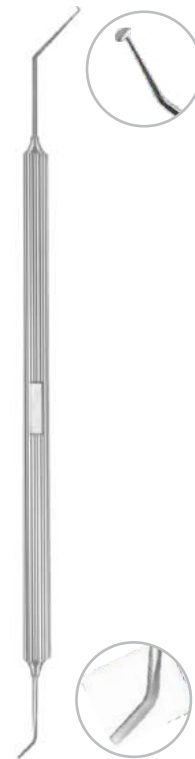

**67-619-13**  
**Sloane LASIK Micro Hoe & Epi Peeler**  
 2.0 mm Wide Semi-Circular Tip With Beveled Edges  
 1 x 5 mm Spatula Shaped Semi Sharp Tip Edge  
 Overall Length 13.5 cm (5 ¼")





Ophthalmology Instruments  
 Ophthalmologie Instrumente  
 Oftalmología Instrumentos  
 Ophthalmologie Instrumente  
 Oftalmologia Strumenti



**67-623-11**  
**Sloane LASIK Epi-Dissector**  
 7.0 mm Long Spatula Shaped Tip  
 With Semi-Sharp Edge  
 Overall Length 11.5 cm (4 1/2")

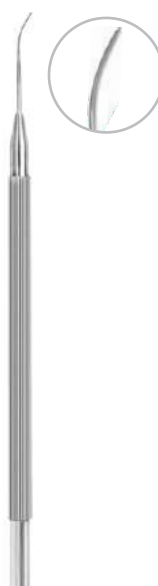

**67-627-12**  
**Sloane LASIK Flap Repositor**  
 Gently Curved Bi-Convex Spatulated Tip  
 With Beveled Smooth Edge  
 Overall Length 12 cm (4 3/4")



**67-629-01**  
**DALK Corneal Dissector**  
 12 mm Long Flat Vaulted Spatula  
 With Beveled Tip  
 Overall Length 12.5 cm (5")



**67-629-02**  
**Rosenwasser DALK Trisector**  
 10 mm Long Triangular Shaft With Spatula Shaped Tip  
 Overall Length 12.5 cm (5")



**67-629-03**  
**Bonfadini DALK Spatula**  
 Vaulted 1.0 mm Wide 8 mm Long Blade Spatula  
 Shaped Blade With Central Groove  
 Overall Length 12.5 cm (5")

Ophthalmology Instruments  
Ophthalmologie Instrumente  
Oftalmologia Instrumentos  
Ophthalmologie Instruments  
Oftalmologia Strumenti

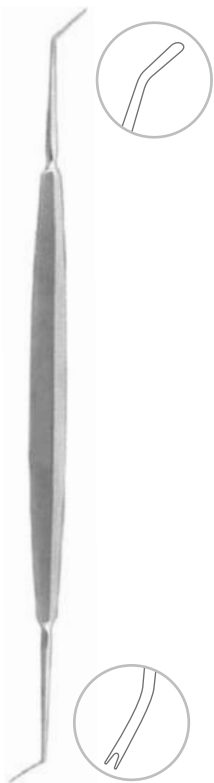

**67-629-14**

**Dastoor Pupil and Iris Repositor**

Double Ended 1 mm Wide Notched Tip on  
One Side and Spatula Shaped Tip on Other side  
Overall Length 13 cm (5")



**67-630-01**

**Culler Iris Spatula**

Straight 1 mm Wide and 28 mm  
Long Spatula  
Overall Length 13 cm (5")



**67-630-02**

**Culler Iris Spatula**

Straight 2 mm Wide and 28 mm  
Long Spatula  
Overall Length 13 cm (5")





Ophthalmology Instruments  
Ophthalmologie Instrumente  
Oftalmología Instrumentos  
Ophthalmologie Instruments  
Oftalmologia Strumenti



**67-632-13**  
**Wheeler Double-End Spatula**  
Double Ended Slightly Curved Spatula Shaped  
Blades (2 x 33 mm Blade on One Side and  
2 x 24 mm Blade on The Other Side)  
Overall Length 13 cm (5")

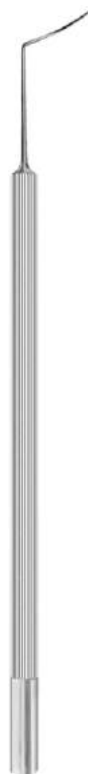

**Barraquer Iris Spatula**  
Overall Length 12 cm (4 3/4")

**67-635-01**  
Vaulted 0.25 mm Wide and 15.0 mm  
Long Blade With Blunt Tip

**67-635-02**  
Vaulted 0.50 mm Wide and 15.0 mm  
Long Blade With Blunt Tip



**67-637-12**  
**Gimbel Nucleus Spatula**  
30° Angled Shaft, 9 mm Long Ø 0.25 mm  
Round Blade  
Overall Length 12.5 cm (5")

Ophthalmology Instruments  
Ophthalmologie Instrumente  
Oftalmologia Instrumentos  
Ophtalmologie Instruments  
Oftalmologia Strumenti

67

OPHTHALMIC SURGERY INSTRUMENTS

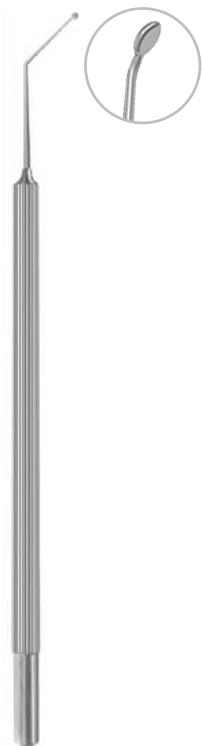

**67-639-12**

**Escaf Nucleus Manipulator**

With 1 mm Wide and 1.4 mm Long Tip  
Angled at 45° - 13 mm Long from Bend  
to Tip Shaft  
Overall Length 12 cm (4 3/4")

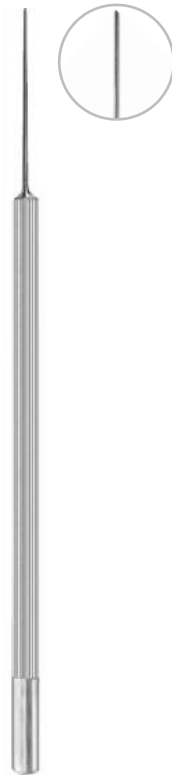

**67-640-12**

**Knolle Nucleus Spatula**

0.5 mm Wide, Flat Malleable Spatula  
Overall Length 12.5 cm (5")



**67-643-01**

**67-643-02**

**Koch Nucleus Spatula**

Overall Length 11.5 cm (4 1/2")

**67-643-01**

Slightly Curved 0.8 mm Wide Duckbill Shaped Tip

**67-643-02**

Slightly Curved 0.8 mm Wide Duckbill Shaped Tip  
With Notches





Ophthalmology Instruments  
 Ophthalmologie Instrumente  
 Oftalmología Instrumentos  
 Ophthalmologie Instruments  
 Oftalmologia Strumenti

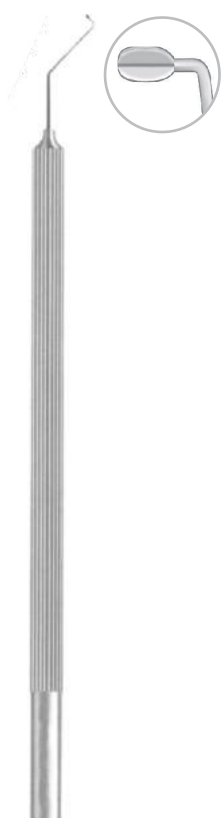

**67-645-11**  
**Akahoshi Nucleus Sustainer**  
 Ø 0.4 mm Ball Shaped Tip 1.8 mm  
 Angled With 10 mm Long Shaft  
 Overall Length 11.5 cm (4 ½")

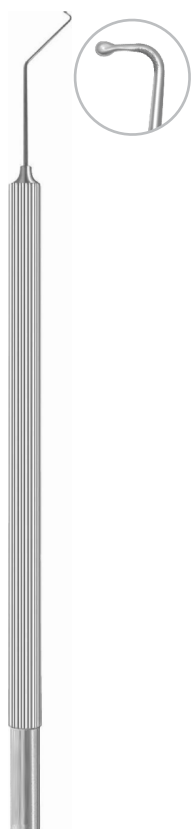

**67-647-12**  
**Escaf Nucleus Sustainer**  
 Ø 0.5 mm Ball Shaped Tip With Inferior Textured  
 Surface 1.8 mm Angled With 10 mm Long Shaft  
 Overall Length 12 cm (4 ¾")

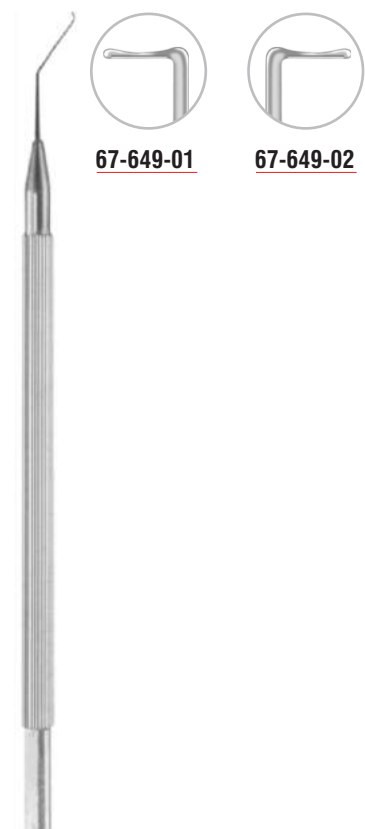

**Lieberman Nucleus Manipulator**  
 Overall Length 12 cm (4 ¾")  
**67-649-01**  
 1.5 mm Curved Right Tip With 10 mm  
 Long Shaft from Bend to Tip  
**67-649-02**  
 1.5 mm Curved Left Tip With 10 mm  
 Long Shaft from Bend to Tip

Ophthalmology Instruments  
 Ophthalmologie Instrumente  
 Oftalmologia Instrumentos  
 Ophtalmologie Instruments  
 Oftalmologia Strumenti

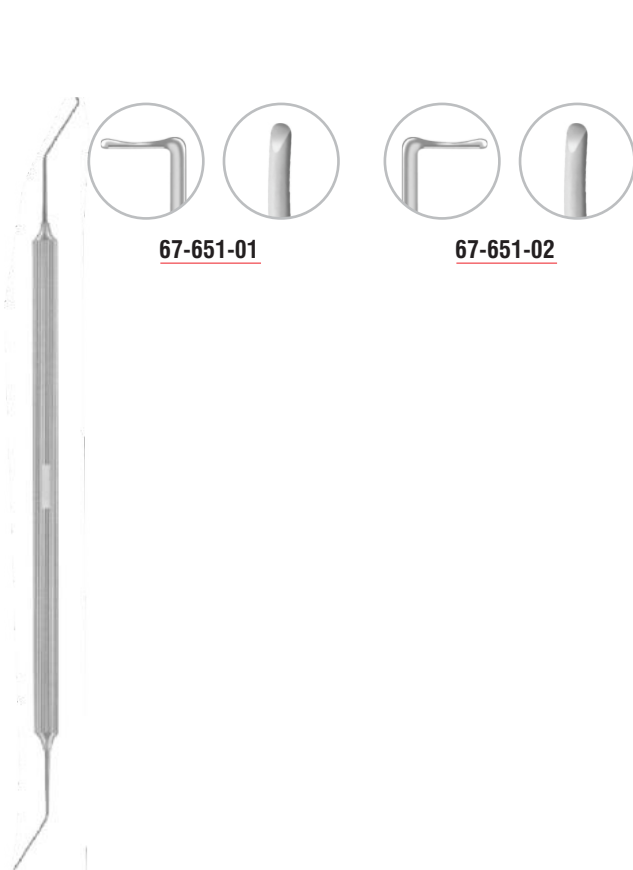

**67-651-01**

**67-651-02**

**Lieberman Nucleus Manipulator and Spatula**

Overall Length 14 cm (5 ½")

**67-651-01**

1.5 mm Curved Right Tip With 10 mm Long Shaft from Bend to Tip on One Side and 1 mm Wide Spatula Shaped Tip on Other Side

**67-651-02**

1.5 mm Curved Left Tip With 10 mm Long Shaft from Bend to Tip on One Side and 1 mm Wide Spatula Shaped Tip on Other Side

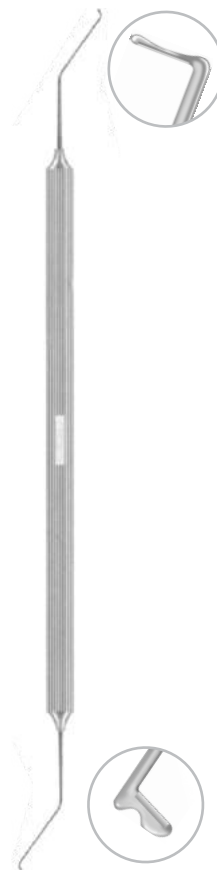

**Fukasaku-Lieberman Nucleus Manipulator and Hook**

Overall Length 13.5 cm (5 ¼")

**67-653-01**

For Right Hand Use 3.5 mm Long Micro Finger Chopper on One Side & 1.25 Long Blunt Tip Hook With 0.8 mm Long Wedge Shaped Inferior Edge & Notch on Front Side on Other Side

**67-653-02**

For Right Hand Use 3.5 mm Long Micro Finger Chopper on One Side & 1.25 Long Blunt Tip Hook With 0.8 mm Long Wedge Shaped Inferior Edge & Notch on Front Side on Other Side





Ophthalmology Instruments  
 Ophthalmologie Instrumente  
 Oftalmología Instrumentos  
 Ophthalmologie Instruments  
 Oftalmologia Strumenti

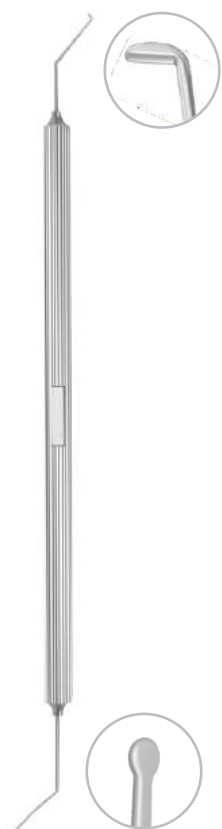

**67-657-13**  
**Masket Phaco Spatula**  
 Combination of Ø 1 mm  
 Disc Shaped Spatula & 0.8 mm  
 Long Rosen Type Phaco Splitter Tip  
 Overall Length 13 cm (5")

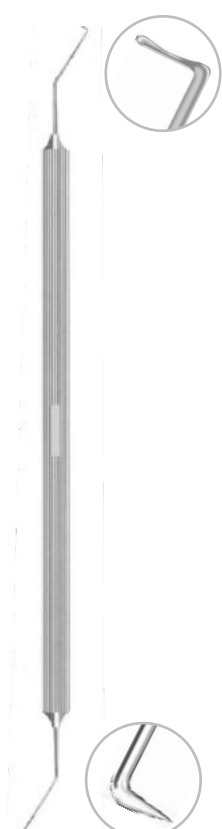

**Chang Phaco Chopper**  
 Overall Length 13 cm (5")  
**67-659-01**  
 For Right Hand Use 3.5 mm Long Micro  
 Finger Chopper on One Side & 0.9 mm  
 Long Quick Chop Tip on Other Side  
**67-659-02**  
 For Left Hand Use 3.5 mm Long Micro Finger  
 Chopper on One Side & 0.9 mm Long Quick  
 Chop Tip on Other Side

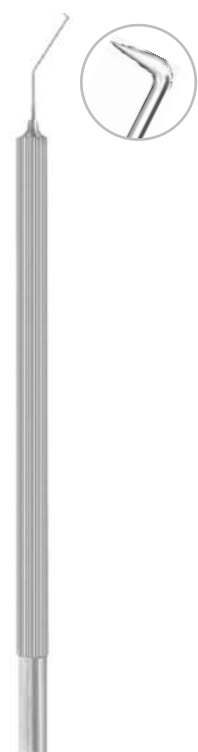

**67-661-11**  
**Minardi Phaco Chopper**  
 30° Angled Shaft With 0.7 mm Long Quick Chop  
 Tip Angle to Tip Length of 10 mm  
 Overall Length 11.5 cm (4 ½")

Ophthalmology Instruments  
 Ophthalmologie Instrumente  
 Oftalmologia Instrumentos  
 Ophtalmologie Instruments  
 Oftalmologia Strumenti

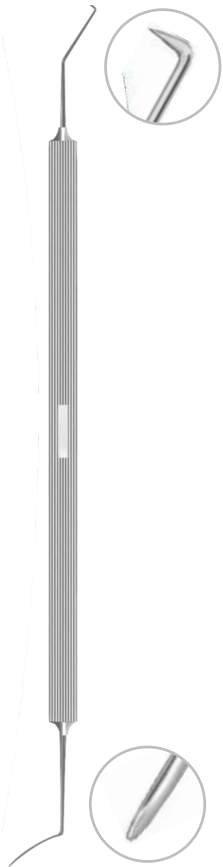

**67-663-13**

**Hwang Phaco Chopper**

Double 1 mm Long Vertical Chopper On One Side and 1 mm Wide Blunt Chisel Tipped Spatula On Other Side, Angle to Tip Length of 10 mm on Both Sides  
 Overall Length 13.5 cm (5 ¼")

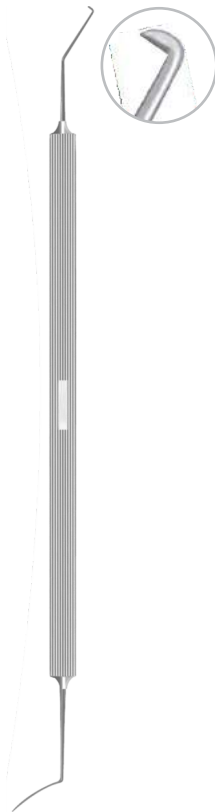

**67-665-11**

**Agarwal Karate Phaco Chopper**

0.9 mm Long Tip With 0.6 mm Semi-Sharp Inferior Edge & Pointed Tip Angle to Tip Length of 11 mm  
 Overall Length 11.5 cm (4 ½")

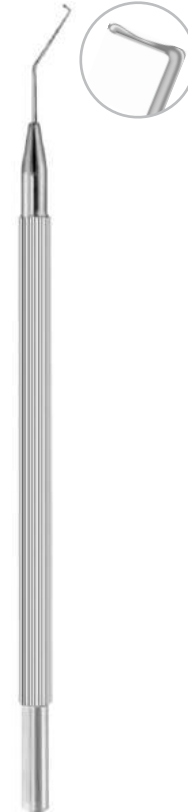

**67-667-11**

**Chang Micro Finger Chopper**

3.5 mm Long Curved Finger Shaped Tip With Defined Inner Edge for Horizontal Chopping, Angle to Tip Length of 10 mm  
 Overall Length 11.5 cm (4 ½")



Ophthalmology Instruments  
Ophthalmologie Instrumente  
Oftalmología Instrumentos  
Ophthalmologie Instrumente  
Oftalmologia Strumenti

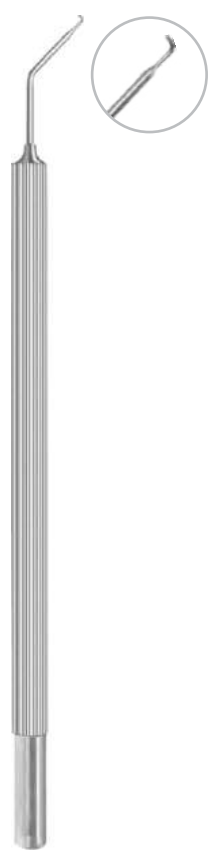

**67-669-12**  
**Brierley Nucleus Splitter**  
1 mm Long Splitter With Incision  
Sealing Shaft Angle Tip Length of  
12 mm  
Overall Length 12 cm (4 3/4")

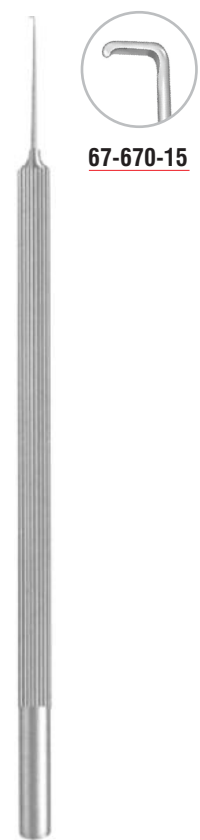

**Dodick-Kammann Nucleus Chopper**  
Overall Length 12 cm (4 3/4")  
**67-670-15**  
Straight Shaft With 1.5 mm Long Chopper  
Tip For Bimanual Nucleus Division  
**67-670-20**  
Straight Shaft With 2.0 mm Long Chopper  
Tip For Bimanual Nucleus Division



**67-670-20**

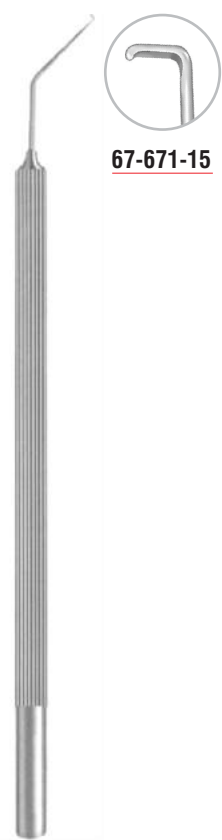

**Dodick-Kammann Nucleus Chopper**  
Overall Length 12 cm (4 3/4")  
**67-671-15**  
Angled Shaft With 1.5 mm Long Chopper  
Tip For Bimanual Nucleus Division, Angle Tip Length  
of 12 mm  
**67-671-20**  
Angled Shaft With 2.0 mm Long Chopper  
Tip For Bimanual Nucleus Division, Angle Tip Length  
of 12 mm



**67-671-20**

Ophthalmology Instruments  
 Ophthalmologie Instrumente  
 Oftalmologia Instrumentos  
 Ophtalmologie Instruments  
 Oftalmologia Strumenti

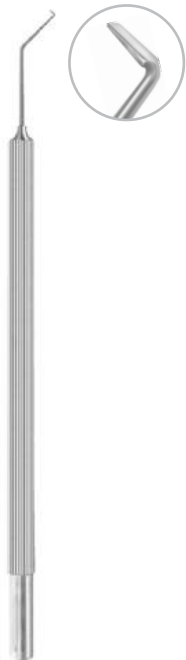

**67-673-12**

**Escaf Nucleus Divider**

1.25 mm Long & 0.5 mm Wide Wedge Shaped Tip for Vertical Chopping  
 Overall Length 12 cm (4 3/4")



**67-675-12**

**Neuhann Nucleus Divider**

0.5 mm Wide Strongly Curved Spatula Shaped Tip  
 Overall Length 12 cm (4 3/4")

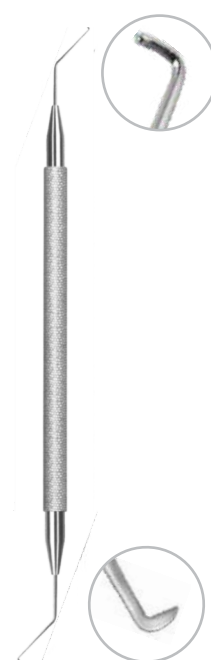

**67-677-11**

**Nagahara Nucleus Lens Spatula & Chopper**

Chopper With 1.5 mm Long Tip With 0.9 mm Long and Blunt Tip on One Side and Spatula With Flat Inferior Edge on Other Side Angle to Tip Length of 10 mm on Both Sides  
 Overall Length 11 cm (4 1/4")

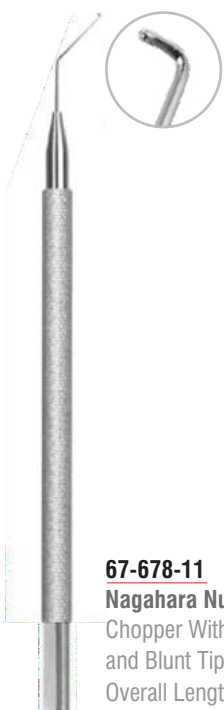

**67-678-11**

**Nagahara Nucleus Chopper**

Chopper With 1.5 mm Long Tip With 0.9 mm Long and Blunt Tip Angle to Tip Length of 10 mm  
 Overall Length 11 cm (4 1/4")

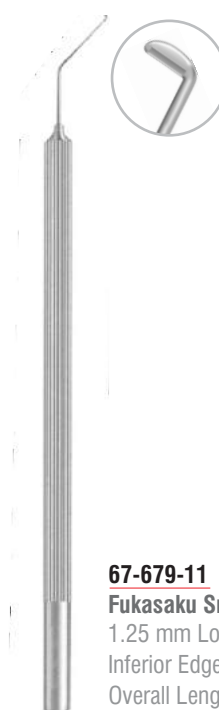

**67-679-11**

**Fukasaku Snapper Hook**

1.25 mm Long Blunt Tip With 0.8 mm Long Wedge Shaped Inferior Edge Angle to Tip Length of 9 mm  
 Overall Length 11.5 cm (4 1/2")





Ophthalmology Instruments  
 Ophthalmologie Instrumente  
 Oftalmología Instrumentos  
 Ophthalmologie Instrumente  
 Oftalmologia Strumenti

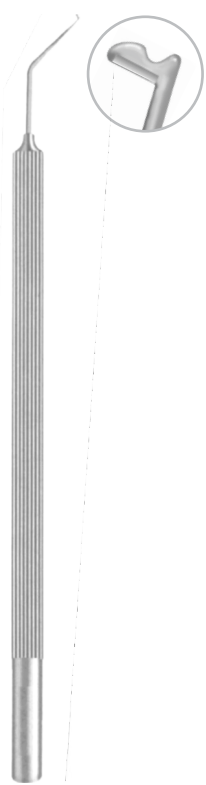

**67-681-11**  
**Fukasaku Snapper Hook & Small Pupil**  
 1.25 mm Long Blunt Tip With 0.8 mm  
 Long Wedge Shaped Inferior Edge &  
 Notch on Front Angle to Tip Length of  
 9 mm  
 Overall Length 11.5 cm (4 1/2")



**67-683-11**  
**Rosen Phaco Splitter**  
 0.8 mm Long Sharp 45°  
 Inferior Cutting Edge Angle  
 to Tip Length of 9 mm  
 Overall Length 11.5 cm (4 1/2")



**67-685-11**  
**Rosen Phaco Splitter**  
 0.8 mm Long Wedge  
 Shaped 60° Inferior  
 Cutting Edge With Blunt Tip  
 Angle to Tip Length of 9 mm  
 Overall Length 11.5 cm (4 1/2")

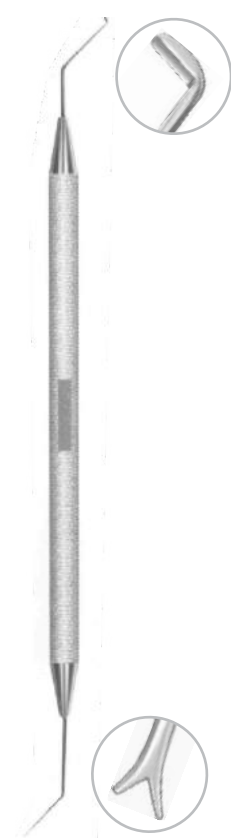

**67-687-13**  
**Rowen Phaco Spatula**  
 Double Ended With Angled  
 Shafts, 9 mm from Angle Tip  
 For Rosen Chopper on One  
 Side and 7 mm Angle To Tip  
 for Bechert Type Nucleus  
 Rotator on Other Side  
 Overall Length 13 cm (5")

Ophthalmology Instruments  
 Ophthalmologie Instrumente  
 Oftalmologia Instrumentos  
 Ophthalmologie Instruments  
 Oftalmologia Strumenti

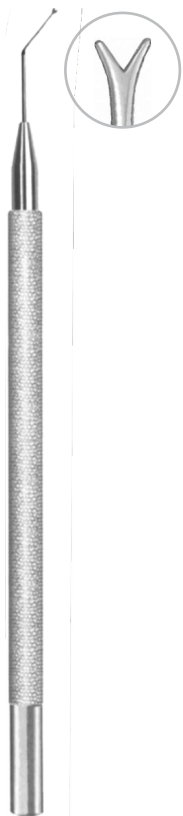

**67-689-01**  
**Bechert Nucleus Rotator**  
 0.78 mm Horizontally Forked Tip With  
 Angled to Tip Length of 7 mm  
 Overall Length 11.5 cm (4 ½")

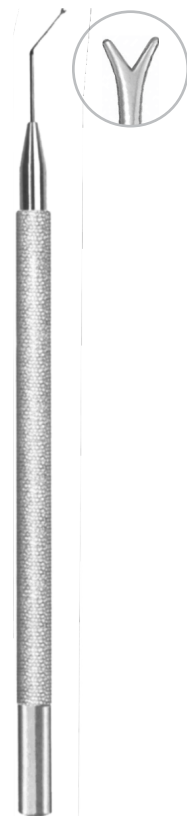

**67-689-02**  
**Jaffe-Bechert Nucleus Rotator**  
 0.78 mm Horizontally Forked Tip With  
 Angled to Tip Length of 9 mm  
 Overall Length 11.5 cm (4 ½")



**67-691-11**  
**Clayman Nucleus Rotator**  
 0.5 mm Wide Flat Spatula With V-Notched Tip  
 Angled to Tip Length of 10 mm  
 Overall Length 12 cm (4 ¾")

Ophthalmology Instruments  
 Ophthalmologie Instrumente  
 Oftalmología Instrumentos  
 Ophthalmologie Instrumente  
 Oftalmologia Strumenti



**67-693-11**  
**Drysdale Nucleus Manipulator**  
 0.8 mm x 2.4 mm Paddle  
 Shaped Tip With Angle to Tip  
 Length of 10 mm  
 Overall Length 11 cm (4 ¼")



**67-695-11**  
**Pisacano Nucleus Rotator**  
 1 mm Horizontal Flat Disc  
 Shaped Tip With Angled to  
 Tip Length of 11 mm  
 Overall Length 11.5 cm (4 ½")



**67-697-11**  
**Pisacano Nucleus Rotator**  
 1 mm Vertical Flat Disc Shaped  
 Tip With Angled to Tip Length  
 of 11 mm  
 Overall Length 11.5 cm (4 ½")



**67-699-11**  
**Siepser Endocapsular Controller**  
 Ø 0.7 mm Trumpet Shaped Tip  
 With Angled to Tip Length of  
 12 mm  
 Overall Length 11.5 cm (4 ½")



Ophthalmology Instruments  
 Ophthalmologie Instrumente  
 Oftalmologia Instrumentos  
 Ophtalmologie Instruments  
 Oftalmologia Strumenti



**67-700-12**  
**Anis Nucleus Manipulator**  
 Straight Shaft & Curved Tip  
 With Ø 0.5 mm Ball at Tip  
 Overall Length 12 cm (4 ¾")



**67-701-12**  
**Anis Nucleus Manipulator**  
 Angled Shaft And Curved Tip  
 With Ø 0.5 mm Ball at Tip,  
 Angle to Tip Length of 10 mm  
 Overall Length 12 cm (4 ¾")

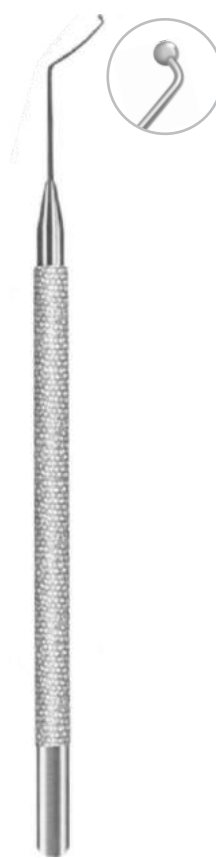

**67-703-12**  
**Tennant Nucleus Rotator**  
 Ø 0.6 mm Ball Shaped Tip  
 With Angled to Tip Length  
 of 10 mm  
 Overall Length 12 cm (4 ¾")



**67-705-11**  
**Lippman Nucleus Spatula**  
 Ø 0.5 mm Shaft With  
 Blunt Forked Tip Angle to Tip  
 Length of 10 mm  
 Overall Length 11.5 cm (4 ½")

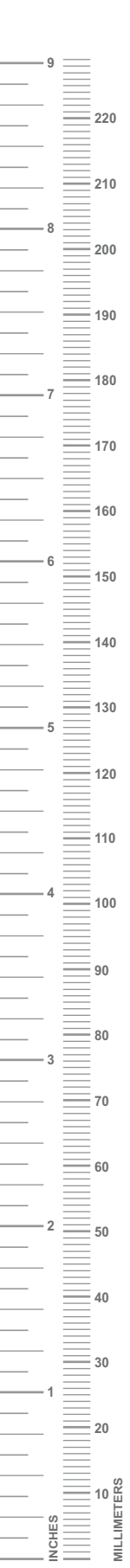

Ophthalmology Instruments  
Ophthalmologie Instrumente  
Oftalmología Instrumentos  
Ophthalmologie Instrumente  
Oftalmologia Strumenti



**67-707-11**  
**Girard Synechia Spatula**  
Vaulted 0.5 mm Wide Blade  
With Semi Sharp Tip  
Angle to Tip Length of 10 mm  
Overall Length 11.5 cm (4 1/2")



**67-709-12**  
**Obstbaum Synechia Spatula**  
0.25 mm Wide Flat Spatula With  
Semi Sharp Tip Angled to Tip Length  
of 10 mm  
Overall Length 12 cm (4 3/4")



**67-711-13**  
**Moran LASIK Enhancement Spatula**  
Double Ended Fukasaku Spatula On  
One Side & Miniature Paton Spatula  
on Other Side  
Overall Length 13.5 cm (5 1/4")

Ophthalmology Instruments  
 Ophthalmologie Instrumente  
 Oftalmologia Instrumentos  
 Ophthalmologie Instruments  
 Oftalmologia Strumenti

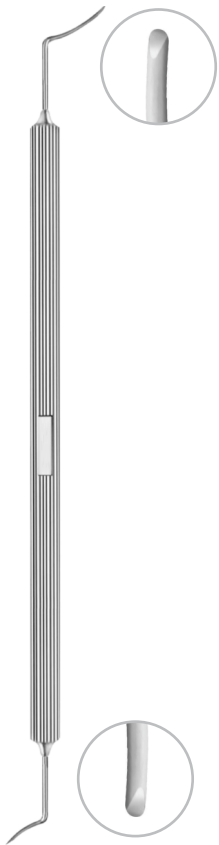

**67-713-14**  
**Hersh IntraLase Flap Spatula**  
 Double Ended 2 x 6 mm and  
 2 x 10 mm Spatula With  
 Beveled Blade Edges  
 Overall Length 14 cm (5 1/4")

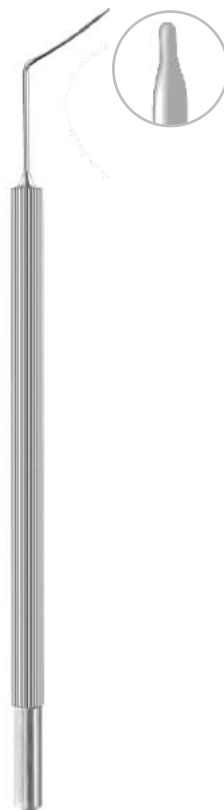

**67-715-13**  
**Binder Flap Separator & Elevator**  
 1 mm Wide Spatula With 0.7 mm Long  
 Rounded Tip (0.1 mm x 0.3 mm), Angle  
 to Tip Length of 10 mm  
 Overall Length 13 cm (5")

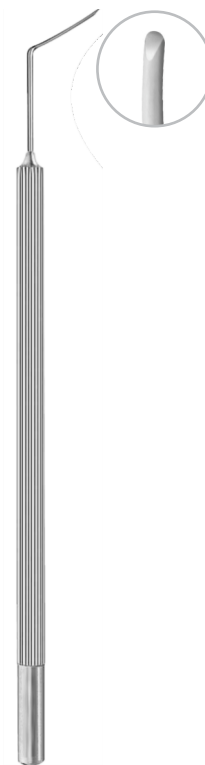

**67-717-12**  
**Fukasaku LASIK Spatula**  
 1.2 mm Wide Gently Curved  
 Spatula With Round Anterior  
 Edge and Flat Posterior  
 Edge, Angled to Tip Length of 12 mm  
 Overall Length 12 cm (4 3/4")

Ophthalmology Instruments  
Ophthalmologie Instrumente  
Oftalmología Instrumentos  
Ophthalmologie Instrumente  
Oftalmologia Strumenti

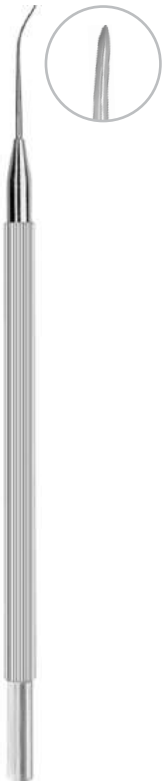

**67-719-12**

**Guimaraes LASIK Spatula**

1.2 mm Wide Gently Curved Bi-Convex Spatula With Semi-Sharp Edge  
Overall Length 12 cm (4 3/4")

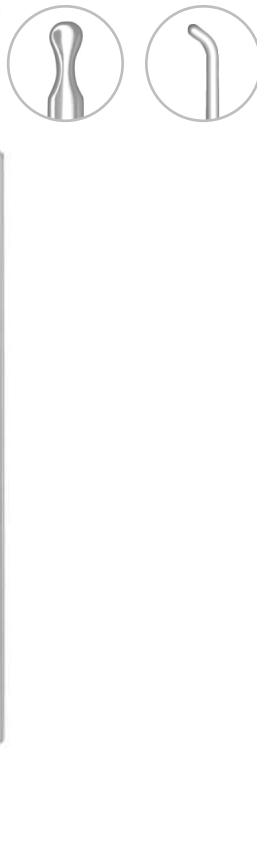

**67-720-13**

**Katzen LASIK Flap Spatula**

Double Ended With 2 mm Wide Bi-Convex Notched Spatula on One Side And Ø 0.2 mm Modified Sinskey Hook on Other Side  
Overall Length 13.5 cm (5 1/4")



**67-723-12**

**Maddox LASIK Spatula**

Double Ended Spatula Combines a 2 mm Wide Flat And a Ø 0.25 mm Cylindrical Spatula With 7 mm from Angle to Tip Length On Both Sides  
Overall Length 12.5 cm (5")

Ophthalmology Instruments  
 Ophthalmologie Instrumente  
 Oftalmologia Instrumentos  
 Ophtalmologie Instruments  
 Oftalmologia Strumenti

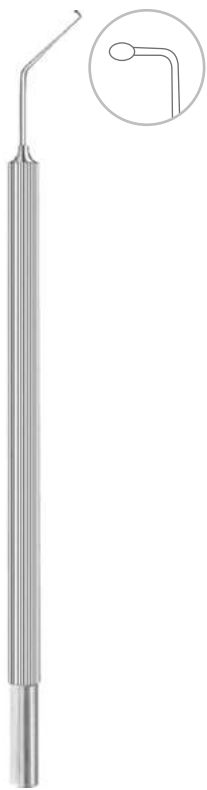
**67-725-11**
**LASIK Flap Manipulator**

Delicate Ø 0.3 mm Olive Tip Manipulator  
 With Angle to Tip Length of 10 mm  
 Overall Length 11.5 cm (4 ½")

**67-726-11**
**Hirschmann Lens Spatula**

0.6 mm Wide Spatula With 0.2 mm  
 Notches on Both Sides  
 Overall Length 11.5 cm (4 ½")

**67-727-12**
**Jaffe Lens Spatula**

0.5 mm Thick Smooth Flat Spatula With Angled  
 to Tip Length of 10 mm  
 Overall Length 12 cm (4 ¾")



Ophthalmology Instruments  
Ophthalmologie Instrumente  
Oftalmología Instrumentos  
Ophthalmologie Instruments  
Oftalmologia Strumenti



**67-728-12**

Straight  $\varnothing$  0.25 mm Hourglass Shaped Tip With 0.5 mm Height

**67-729-12**

Angled  $\varnothing$  0.25 mm Hourglass Shaped Tip With 0.5 mm Height With Angled to Tip Length of 10 mm

**Lester IOL Manipulator**  
Overall Length 12 cm (4 3/4")

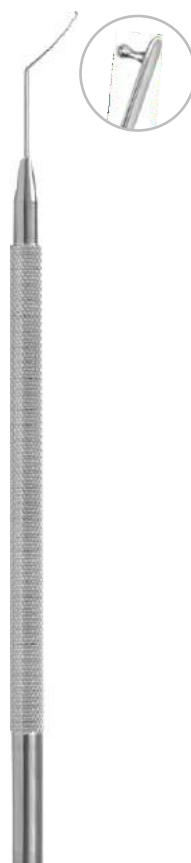

**67-731-11**

**Lester IOL Manipulator**  
 $\varnothing$  0.25 mm Hourglass Shaped Tip With 0.5 mm Height With Angled to Tip Length of 10 mm Vaulted Shanks  
Overall Length 11.5 cm (4 1/2")



**67-733-12**

**Hunkeler IOL Manipulator**  
 $\varnothing$  0.3 mm Hemi-Ball Shaped Tip With Angle to Tip Length of 10 mm  
Overall Length 12 cm (4 3/4")

Ophthalmology Instruments  
 Ophthalmologie Instrumente  
 Oftalmologia Instrumentos  
 Ophtalmologie Instruments  
 Oftalmologia Strumenti

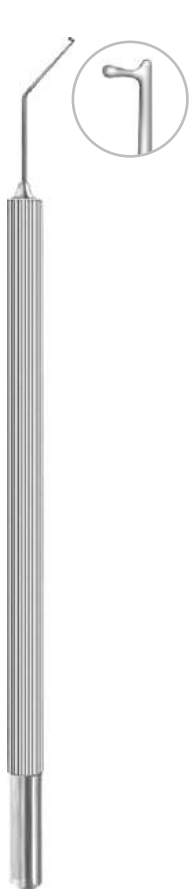

**67-735-12**  
**Alio-Kelman IOL Hook**  
 Ø 0.2 mm Tip With  
 0.5 mm Height With Angle  
 to Tip Length of 10 mm  
 Overall Length 12 cm (4 ¾")



**67-738-12**  
**Aker Lens Pusher**  
 0.8 mm Smooth, Fish  
 Mouth Shaped Jaws  
 Overall Length 12.5 cm (5")

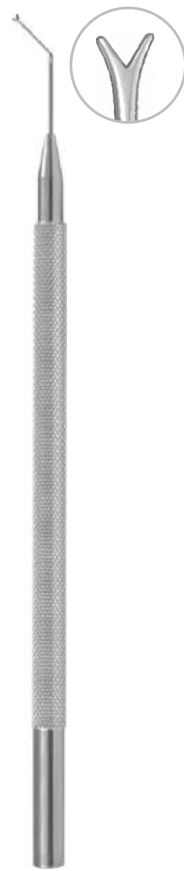

**67-739-11**  
**Bechert Lens Pusher**  
 0.78 mm Vertically Forked  
 Tip With Angled to Tip  
 Length of 10 mm  
 Overall Length 11.5 cm (4 ½")



**67-741-13**  
**Elschnig Cyclodialysis Spatula**  
 Blunt Tip 1 mm Wide Spatula  
 With Angle To Tip Length of 10 mm  
 Overall Length 11.5 cm (4 ½")

Ophthalmology Instruments  
Ophthalmologie Instrumente  
Oftalmología Instrumentos  
Ophthalmologie Instruments  
Oftalmologia Strumenti



**67-743-13**  
**Castroviejo Synechia Spatula**  
Double Ended Spatula 0.5 mm Wide With  
0.25 mm Thickness of Blades, 10 mm From  
Angle to Tip on One Side and 15 mm From  
Angle to Tip on Other Side, Semi Sharp Tips  
Overall Length 13 cm (5")

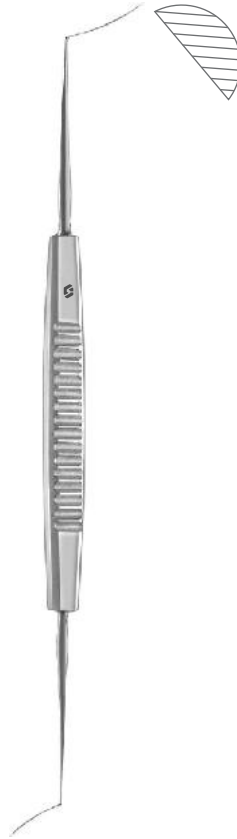

**67-745-25**  
**Castroviejo Cyclodialysis Spatula**  
Overall Length 13 cm (5")

**67-745-25**  
Double Ended Spatula 0.25 mm Wide With  
0.25 mm Thickness 10 mm From Angle to  
Tip on One Side and 15 mm From Angle to  
Tip on Other Side, Blunt Tip

**67-745-50**  
Double Ended Spatula 0.25 mm Wide With  
0.5 mm Thickness 10 mm From Angle to  
Tip on One Side and 15 mm From Angle to  
Tip on Other Side, Blunt Tip



**67-749-12**  
**Barrett Nucleus Expressor**  
Curved Shaft With Ø 2 mm Bulbous Tip  
Overall Length 12 cm (4 ¾")

Ophthalmology Instruments  
Ophthalmologie Instrumente  
Ofthalmologia Instrumentos  
Ophtalmologie Instruments  
Ofthalmologia Strumenti



**Lewis Lens Loop**  
Overall Length 13 (5")

**67-750-01**  
Smooth 5 mm Wide Curved Loop Shaped Tip

**67-750-02**  
Smooth 6 mm Wide Curved Loop Shaped Tip



**67-752-13**  
**New Orleans Lens Loop**  
Smooth 5 mm Wide Slightly Curved  
Loop Shaped Tip  
Overall Length 13.5 cm (5 1/4")



**67-754-13**  
**Wilder Lens Loop**  
Serrated 4 mm Wide Curved Loop  
Shaped Tip  
Overall Length 13.5 cm (5 1/4")

Ophthalmology Instruments  
Ophthalmologie Instrumente  
Oftalmología Instrumentos  
Ophthalmologie Instrumente  
Oftalmologia Strumenti



**67-757-15**  
**Kirby Lens Loop and Muscle Hook**  
Double Ended With 5 mm Wide Loop Shaped Tip on One Side and 12 mm Muscle Hook on Other Side With 2.0 mm Bulbous Tip  
Overall Length 15 cm (6")



**67-758-14**  
**Morrison Lens Loop and Probe**  
Double Ended With 4.5 mm Wide Loop Shaped Tip on One Side and Ø 0.8 mm Olive Tip Probe on Other Side  
Overall Length 14.5 cm (5 3/4")



**67-760-13**  
**Kansas Lens Loop**  
Serrated 3.0 mm Wide Slightly Curved Loop Shaped Tip  
Overall Length 13.5 cm (5 1/4")

Ophthalmology Instruments  
Ophthalmologie Instrumente  
Oftalmologia Instrumentos  
Ophtalmologie Instruments  
Oftalmologia Strumenti



**67-761-13**  
**Keener-Arlt Lens Loop**  
Serrated 3.0 mm Wide Curved  
Loop Shaped Tip  
Overall Length 13.5 cm (5 1/4")



**67-765-10**  
**Alfonso Nucleus Trisector**  
Oval 2.5 mm Wide Semi Sharp Fenestrated  
Blade To Be Used With 67-775-02  
Overall Length 10.5 cm (4 1/4")



**67-767-10**  
**Bucher-Kansas Nucleus Trisector**  
Triangular 2.5 mm Wide Semi Sharp  
Fenestrated Blade To Be Used With 67-775-03  
Overall Length 10.5 cm (4 1/4")

Ophthalmology Instruments  
Ophthalmologie Instrumente  
Oftalmología Instrumentos  
Ophthalmologie Instrumente  
Oftalmologia Strumenti



**67-769-11**  
**Kansas Nucleus Trisector**  
Triangular 4 mm Wide Semi Sharp Fenestrated Blade To Be Used With 67-773-12  
Overall Length 11 cm (4 1/4")



**67-771-11**  
**Kansas Nucleus Bisector**  
10 mm Long Semi Sharp Blade Used With 67-773-12 For Small Manual Incision Surgery  
Overall Length 11.5 cm (4 1/4")



**67-773-12**  
**Kansas Nucleus Vectis**  
3.0 mm Wide Spatula Shaped Blade  
Overall Length 12 cm (4 3/4")

Ophthalmology Instruments  
Ophthalmologie Instrumente  
Oftalmologia Instrumentos  
Ophtalmologie Instruments  
Oftalmologia Strumenti



**Alfonso Cutting Platform**  
Overall Length 12.5 cm (5")

**67-775-02**

2.0 mm Wide Blade Used as Cutting  
Block For Nucleus Bisector and Trisector

**67-775-03**

3.0 mm Wide Blade Used as Cutting  
Block For Nucleus Bisector and Trisector



**67-779-12**  
**Giannetti Nucleus Capture Spoon**  
Inclined, Arcuate 2.6 mm Wide Spoon  
Overall Length 12.5 cm (5")



**67-781-12**  
**Giannetti Nucleus Capture Spatula**  
2 mm Wide Blunt Tip Arcuate Nucleus  
Capture Spatula  
Overall Length 12.5 cm (5")



Ophthalmology Instruments  
Ophthalmologie Instrumente  
Oftalmología Instrumentos  
Ophthalmologie Instrumente  
Oftalmologia Strumenti



**67-783-12**  
**Giannetti Nucleus Capture Hook**  
Straight Hook For Nucleus Manipulation  
Overall Length 12.5 cm (5")



**67-790-13**  
**Culler Lens Spoon**  
5 x 9 mm Spoon Shaped Tip  
Overall Length 13 cm (5")



**67-793-14**  
**Paton Spatula & Spoon**  
6 mm Wide and 15 mm Long Grooved Spoon Blade and  
2 x 31 mm Spatula Shaped Blade With Last 7 mm Angled Tip  
Overall Length 14 cm (5 1/2")

Ophthalmology Instruments  
Ophthalmologie Instrumente  
Ofthalmologia Instrumentos  
Ophthalmologie Instruments  
Ofthalmologia Strumenti

67

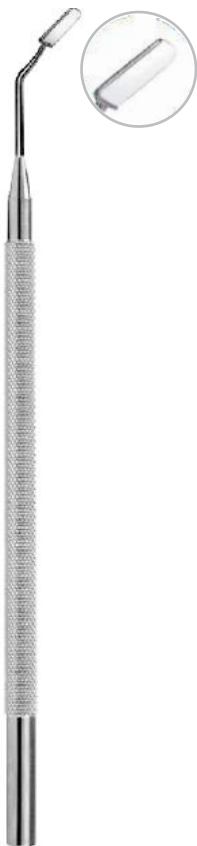

**67-795-04**

**Rosenwasser Lamella Donor Shovel**

9 mm Long and 4 mm Wide Plate With Retaining  
Rim on Two Sides  
Overall Length 11.5 cm (4 ½")



**67-795-05**

**Rosenwasser Lamella Donor Shovel**

9 mm Long and 5 mm Wide Plate With Retaining  
Rim on Three Sides  
Overall Length 11.5 cm (4 ½")



Ophthalmology Instruments  
Ophthalmologie Instrumente  
Oftalmología Instrumentos  
Ophthalmologie Instruments  
Oftalmologia Strumenti



**67-796-00**  
**Carter Sphere Introducer**  
With Spring Loaded Plunger To Hold and Introduce Eye Spheres  
Overall Length 12.5 cm (5")



**67-798-00**  
**Foster Enucleation Snare**  
With Ratcheting Wing-Nut Handle  
Overall Length 14.5 cm (5.½")



**67-798-90**  
**Twisted Wires For Foster Enucleation Snare**  
Pack of 12



**67-799-13**  
**Eye Enucleation Forcep**  
Curved, S Shaped, Longitudinally Serrated  
Overall Length 13.5 cm (5 ¼")

Ophthalmology Instruments  
Ophthalmologie Instrumente  
Oftalmologia Instrumentos  
Ophtalmologie Instruments  
Oftalmologia Strumenti



**67-800-01**  
**Bunge Evisceration Spoon**  
Flat and Smooth Ø 10.0 mm Spoon  
Shaped Blade  
Overall Length 14 cm (5 ½")



**67-800-02**  
**Bunge Evisceration Spoon**  
Flat and Smooth Ø 12.0 mm  
Spoon Shaped Blade  
Overall Length 14 cm (5 ½")



**67-802-15**  
**Wells Enucleation Spoon**  
21 mm Wide Spoon With  
5 x 10 mm Notch  
Overall Length 15 cm (6")



**67-803-00**  
**Dastoor Erisophake (Bell)**  
Overall Length 6 cm (2 ¼")



Ophthalmology Instruments  
Ophthalmologie Instrumente  
Oftalmología Instrumentos  
Ophthalmologie Instrumente  
Oftalmologia Strumenti

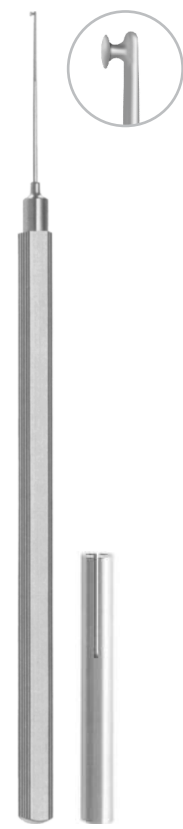

**67-804-12**  
**Graether Collar Button**  
Straight, Ø 0.6 mm Collar Button Shaped  
Micro Iris Retractor  
Overall Length 12.5 cm (5")

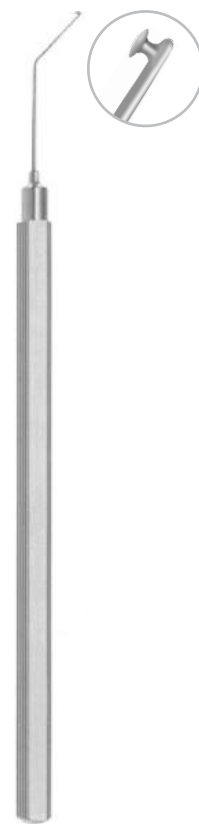

**67-805-12**  
**Graether Collar Button**  
Angled, Ø 0.6 mm Collar Button Shaped  
Micro Iris Retractor With Angle to Tip  
Length of 10 mm  
Overall Length 12.5 cm (5")

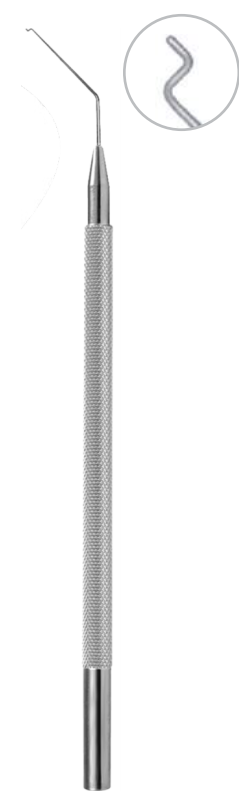

**67-811-11**  
**Z Hook Manipulator**  
Ø 0.2 mm Z Shaped Hook With Angle to  
Tip Length of 10 mm  
Overall Length 11.5 cm (4 ½")

Ophthalmology Instruments  
 Ophthalmologie Instrumente  
 Oftalmologia Instrumentos  
 Ophtalmologie Instruments  
 Oftalmologia Strumenti



**67-813-11**  
**Sinskey (Reversed) Lens Manipulating Hook**  
 Ø 0.2 mm Blunt Tip With 0.35 mm Height  
 With Angle to Tip Length of 10 mm  
 Overall Length 11.5 cm (4 ½")



**67-815-12**  
**Bonn Micro Iris Hook**  
 Curved Hook With Ø 0.15 mm Blunt Tip  
 Overall Length 12.5 cm (5")



**67-817-12**  
**Shepard Iris Hook**  
 1.0 mm Wide Ø 0.2 mm Blunt Tip  
 Overall Length 12.5 cm (5")



Ophthalmology Instruments  
 Ophthalmologie Instrumente  
 Oftalmología Instrumentos  
 Ophthalmologie Instrumente  
 Oftalmologia Strumenti



**67-819-01**  
**Jaffe Lens Manipulating Hook**  
 Ø 0.15 mm Hook and 0.35 mm Height,  
 Flat Handle  
 Overall Length 11.5 cm (4 ½")



**67-819-02**  
**Clayman-Jaffe Lens Manipulating Hook**  
 Ø 0.15 mm Hook and 0.35 mm Height With  
 Angle to Tip Length of 10 mm Flat Handle  
 Overall Length 11.5 cm (4 ½")



**67-821-01**  
**Sinskey Lens Manipulating Hook**  
 Ø 0.25 mm Blunt Tip With 0.35 mm  
 Height, Flat Handle  
 Overall Length 11.5 cm (4 ½")



**67-821-02**  
**Harris-Sinskey Lens Manipulating Hook**  
 Ø 0.25 mm Blunt Tip With 0.35 mm Height With  
 Angle to Tip Length of 10 mm Flat Handle  
 Overall Length 11.5 cm (4 ½")



**67-823-12**  
**Lewicky Lens Manipulating Hook**  
 Vaulted Shaft, Ø 0.2 mm Blunt Tip With Angle  
 to Tip Length of 11 mm  
 Overall Length 12 cm (4 ¾")

Ophthalmology Instruments  
Ophthalmologie Instrumente  
Oftalmologia Instrumentos  
Ophtalmologie Instruments  
Oftalmologia Strumenti



**67-825-11**

**Hirschmann Iris Hook**

Ø 0.2 mm Blunt Round Tip  
Angled to Tip Length of 10 mm  
Overall Length 11 cm (4 ¼")



**67-826-01**

**Sinskey Lens Manipulating Hook**

Ø 0.25 mm Blunt Tip With 0.35 mm  
Height  
Overall Length 11 cm (4 ½")

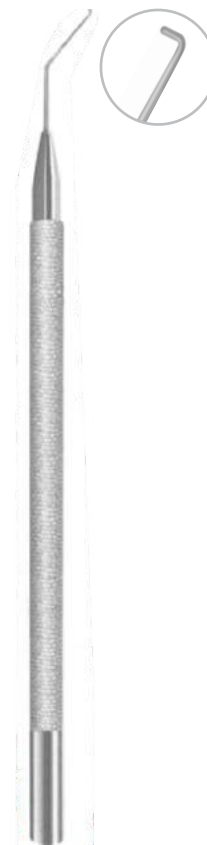

**67-826-02**

**Sinskey Lens Manipulating Hook**

Ø 0.25 mm Blunt Tip With 0.35 mm  
Height With Angle to Tip Length of  
10 mm  
Overall Length 11 cm (4 ½")





Ophthalmology Instruments  
 Ophthalmologie Instrumente  
 Oftalmología Instrumentos  
 Ophthalmologie Instrumente  
 Oftalmologia Strumenti



**67-826-03**  
**Sinskey II Lens Manipulating Hook**  
 Ø 0.2 mm Blunt Tip With 0.35 mm  
 Height  
 Overall Length 11.5 cm (4 ½")



**67-826-04**  
**Sinskey II Lens Manipulating Hook**  
 Ø 0.2 mm Blunt Tip With 0.35 mm  
 Height With Angle to Tip Length of  
 10 mm  
 Overall Length 11.5 cm (4 ½")



**67-827-01**  
 Straight  
 0.76 mm x 0.75 mm  
 x 0.25 mm Rotator Tip



**67-827-02**  
 Angled  
 0.76 mm x 0.75 mm  
 x 0.25 mm Rotator Tip

**Kuglen Iris Hook and Lens Manipulator**  
 Overall Length 11.5 cm (4 ½")

Ophthalmology Instruments  
Ophthalmologie Instrumente  
Ofthalmologia Instrumentos  
Ophtalmologie Instruments  
Ofthalmologia Strumenti



**67-829-01**  
**Kuglen Iris Hook and Lens Manipulator**  
0.76 mm x 0.75 mm x 0.25 mm Clover  
Leaf Model Tip  
Overall Length 11.5 cm (4 1/2")



**67-831-12**  
**Rentsch Boat Hook**  
Ø 0.2 mm Double Hooks  
Overall Length 12 cm (4 3/4")

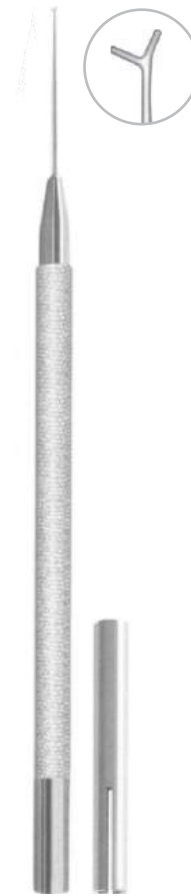

**67-833-12**  
**Osher Y Hook**  
0.67 mm Wide Vertical Fork Shaped  
Tips With Angled to Tip Length of 9 mm  
Overall Length 12 cm (4 3/4")

Ophthalmology Instruments  
 Ophthalmologie Instrumente  
 Oftalmología Instrumentos  
 Ophthalmologie Instrumente  
 Oftalmologia Strumenti



**67-835-01**  
**Fenzl Lens Manipulating Hook**  
 Ø 0.15 mm Hook and  
 0.5 mm Height  
 Overall Length 12 cm (4 ¾")



**67-835-02**  
**Fenzl Lens Manipulating Hook**  
 Ø 0.15 mm Hook and  
 0.5 mm Height With Angle to  
 Tip Length of 9 mm  
 Overall Length 12 cm (4 ¾")



**67-837-01**  
 Straight  
 Ø 0.15 mm Dual Fork  
 Shaped Tip



**67-837-02**  
 Angled  
 Ø 0.15 mm Dual Fork  
 Shaped Tip With Angle  
 to Tip Length of 9 mm

**Maltzman-Fenzl Lens Manipulating Hook**  
 Overall Length 12 cm (4 ¾")

Ophthalmology Instruments  
 Ophthalmologie Instrumente  
 Oftalmologia Instrumentos  
 Ophtalmologie Instruments  
 Oftalmologia Strumenti



**67-839-02**  
**Jaffe-Maltzman Lens Manipulating Hook**  
 Angled, Ø 0.15 mm Dual Fork  
 Shaped Tip With Angle to Tip Length of  
 11 mm  
 Overall Length 12 cm (4 ¾")



**67-841-01**  
**Giannetti Push Pull Manipulator**  
 Straight  
 0.76 mm x 0.75 mm x 0.25 mm Tip  
 Overall Length 12.5 cm (5")



**67-843-02**  
**Deitz ICL Manipulator**  
 0.8 mm Wide Vertical Fork  
 Shaped Tips, 11 mm Long  
 From Bend to Tip  
 Overall Length 12 cm (4 ¾")

*ICL® is a registered trademark of  
 STAAR Surgical Company*

Ophthalmology Instruments  
Ophthalmologie Instrumente  
Oftalmología Instrumentos  
Ophthalmologie Instruments  
Oftalmologia Strumenti



**67-845-01**  
**Fixation Hook**  
Curved 2 Sharp  
Pronged Hook With  
1.5 mm Spread  
Overall Length 12.5 cm (5")



**67-845-02**  
**Fixation Hook**  
Curved 2 Sharp  
Pronged Hook With  
2.0 mm Spread  
Overall Length 12.5 cm (5")



**Twist Hook**  
0.3 mm Hook  
Overall Length 11 cm (4 1/4")



**67-849-01**  
Right  
(Clockwise)



**67-849-02**  
Left  
(Counter-Clockwise)



**67-851-09**  
**Silverman Fixation Hook**  
Blunt Cone Shaped Tips With  
3.0 mm Spread  
Overall Length 9.5 cm (3 3/4")

Ophthalmology Instruments  
Ophthalmologie Instrumente  
Ofthalmologia Instrumentos  
Ophtalmologie Instruments  
Ofthalmologia Strumenti



**67-861-11**

**Lu-Mendez Fixation Ring and Guide**  
I.D. Ø 11 mm, LRI Guide Marked in 10°  
Increments and Fixation Ring With 15  
Blunt Teeth  
Overall Length 11 cm (4 ¼")

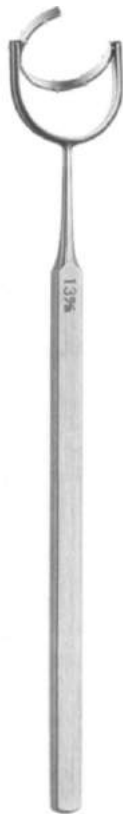

**67-863-11**

**Gimbel Stabilization Ring**  
Offset C Shaped Swivel Fixation  
Ring With Ø 13 mm With  
10 mm Opening and 9 Blunt Teeth  
Overall Length 11.5 cm (4 ½")



**67-865-13**

C Shaped Swivel Fixation Ring  
With Ø 13 mm With  
10 mm Opening and 9 Blunt Teeth

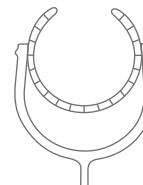

**67-865-16**

C Shaped Swivel Fixation Ring  
With Ø 16 mm With  
10 mm Opening and 12 Blunt Teeth

**Fine-Thornton Swivel Fixation Ring**

Overall Length 12 cm (4 ¾")

Ophthalmology Instruments  
 Ophthalmologie Instrumente  
 Oftalmología Instrumentos  
 Ophthalmologie Instrumente  
 Oftalmologia Strumenti



**67-867-10**  
**Thornton Globe Fixation Ring**  
 Ø 16 mm Globe Fixation Ring  
 With 12 Blunt Teeth  
 Overall Length 10 cm (4")



**67-869-11**  
**Hofmann-Thornton Globe Fixation Ring**  
 Ø 16 mm Globe Fixation Ring With  
 Swivel Handle And 12 Blunt Teeth  
 Overall Length 11 cm (4 1/4")



**67-871-12**  
**Stevens Tenotomy Hook**  
 Curved 6 mm Wide Hook  
 Overall Length 12.5 cm (5")



**67-872-12**  
**Manson Double Strabismus Hook**  
 Angled 3.0 mm Wide Fork Shaped  
 Tips With 7.0 mm Spread  
 Overall Length 12.5 cm (5")

Ophthalmology Instruments  
Ophthalmologie Instrumente  
Ofthalmologia Instrumentos  
Ophtalmologie Instruments  
Ofthalmologia Strumenti



**67-873-12**  
**Helveston Teaser Hook**  
Angled 6 mm Wide Blunt Tip Hook  
Overall Length 12.5 cm (5")



**67-875-13**  
**Gass Retinal Detachment Hook**  
Flattened 13 mm Wide Graefe  
Type Hook With 1.5 mm Oval Eye  
13 cm (5")



**Helveston Finder Hook**  
Overall Length 12.5 cm (5")

**67-877-01**  
Small 8 mm Wide Hook  
With Extra Delicate Cone  
Shaped Tip

**67-877-02**  
Large 12 mm Wide Hook With  
Extra Delicate Cone Shaped Tip



Ophthalmology Instruments  
 Ophthalmologie Instrumente  
 Oftalmología Instrumentos  
 Ophthalmologie Instrumente  
 Oftalmologia Strumenti



**67-879-01**  
8 mm Wide

**67-879-02**  
10 mm Wide

**67-879-03**  
12 mm Wide

**Helveston Muscle Hook**  
Blunt Spatula Shaped Tip  
Overall Length 13 cm (5")



**67-881-01**  
**Jameson Muscle Hook**  
Small, 6 mm Wide Hook  
With 2 mm Bulbous Tip  
Overall Length 13 cm (5")



**67-881-02**  
**Jameson Muscle Hook**  
Large, 8 mm Wide Hook  
With 2 mm Bulbous Tip  
Overall Length 13.5 cm (5 1/4")

Ophthalmology Instruments  
 Ophthalmologie Instrumente  
 Oftalmologia Instrumentos  
 Ophtalmologie Instruments  
 Oftalmologia Strumenti



**67-883-13**  
**Green Strabismus Hook**  
 Flat 8 mm Wide Hook  
 Overall Length 13.5 cm (5 ¼")



**67-885-13**  
**Chavasse Strabismus Hook**  
 12 mm Wide W Shaped Hook  
 Overall Length 13 cm (5")

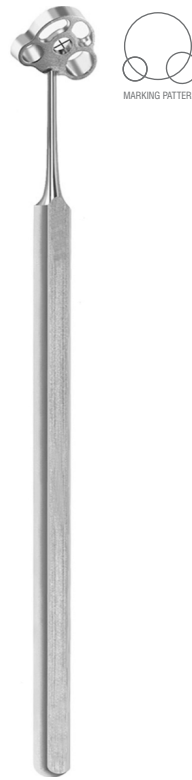

**67-887-11**  
**Chayet Corneal Marker**  
 For LASIK Surgery  
 Overall Length 11.5 cm (4 ½")



**67-891-11**  
**Kellen Capsulorrhexis Marker**  
 Ø 6 mm Marking Ring  
 With 2.5 mm Extensions  
 Overall Length 11.5 cm (4 ½")

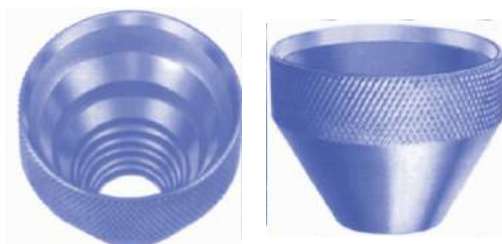

**67-900-00**  
**Maloney Intra-Operative Keratometer**  
 For Qualitative Measurement of Astigmatism  
 Cone Shaped With Maximum Ø 31.0 mm  
 and 21.5 cm Height, Titanium  
 Overall Length 11.5 cm (4 ½")



Ophthalmology Instruments  
 Ophthalmologie Instrumente  
 Oftalmología Instrumentos  
 Ophthalmologie Instrumente  
 Oftalmologia Strumenti



**67-901-11**  
**Mendez Degree Gauge**  
 Ø 12.0 mm I.D. and 18.0 mm O.D.  
 Measures 0-180° With 10° Increments  
 Overall Length 11.5 cm (4 ½")



**67-905-11**  
**Greene Visual Axis Marker**  
 Ø 0.5 mm With Concave Tip  
 Overall Length 11.5 cm (4 ½")



**67-907-11**  
**McDonald Optic Zone Marker**  
 Double Ended, With Cross Hairs  
 Ø 6.5 mm and 7.0 mm  
 Overall Length 11 cm (4 ½")

Ophthalmology Instruments  
 Ophthalmologie Instrumente  
 Oftalmologia Instrumentos  
 Ophtalmologie Instruments  
 Oftalmologia Strumenti



<b><u>67-911-01</u></b> Ø 3.0 mm	<b><u>67-911-02</u></b> Ø 3.25 mm	<b><u>67-911-03</u></b> Ø 3.5 mm	<b><u>67-911-04</u></b> Ø 3.75 mm	<b><u>67-911-05</u></b> Ø 4.0 mm	<b><u>67-911-06</u></b> Ø 4.25 mm	<b><u>67-911-07</u></b> Ø 4.5 mm	<b><u>67-911-08</u></b> Ø 4.75 mm
<b><u>67-911-09</u></b> Ø 5.0 mm	<b><u>67-911-10</u></b> Ø 6.0 mm	<b><u>67-911-11</u></b> Ø 7.0 mm	<b><u>67-911-12</u></b> Ø 8.0 mm	<b><u>67-911-13</u></b> Ø 9.0 mm			

**Bores Optic Zone Marker**  
 Without Cross Hairs  
 Overall Length 10.5 cm (4 1/4")



<b><u>67-913-01</u></b> Ø 3.0 mm	<b><u>67-913-02</u></b> Ø 3.25 mm	<b><u>67-913-03</u></b> Ø 3.5 mm	<b><u>67-913-04</u></b> Ø 3.75 mm	<b><u>67-913-05</u></b> Ø 4.0 mm	<b><u>67-913-06</u></b> Ø 4.25 mm	<b><u>67-913-07</u></b> Ø 4.5 mm	<b><u>67-913-08</u></b> Ø 4.75 mm
<b><u>67-913-09</u></b> Ø 5.0 mm	<b><u>67-913-10</u></b> Ø 5.5 mm	<b><u>67-913-11</u></b> Ø 6.0 mm	<b><u>67-913-12</u></b> Ø 7.0 mm	<b><u>67-913-13</u></b> Ø 8.0 mm	<b><u>67-914-14</u></b> Ø 9.0 mm		

**Hoffer Optic Zone Marker**  
 With Cross Hairs  
 Overall Length 10.5 cm (4 1/4")

Ophthalmology Instruments  
 Ophthalmologie Instrumente  
 Oftalmología Instrumentos  
 Ophtalmologie Instruments  
 Oftalmologia Strumenti



**67-915-08**

With 8 Radial Blades

**67-915-12**

With 12 Radial Blades

**67-915-16**

With 16 Radial Blades

**Anis Radial Marker**

Overall Length 10 cm (4")



**67-917-10**

**Anis Corneal Suture Placement Marker**

Ø 8 mm Center Opening and 8 Radial Blades  
 Overall Length 10 cm (4")



**67-919-09**

**Fechtner Trabeculectomy Marker**

With U-Shaped 2.75mm Marking  
 Pattern and Side Landmarks  
 Overall Length 9 cm (3 1/2")

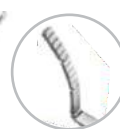

**67-930-12**

**Helveston Scleral Ruler**

Vaulted 15 mm Long Blade  
 With Notches in 5 mm Increments  
 Overall Length 12 cm (4 3/4")

Ophthalmology Instruments  
 Ophthalmologie Instrumente  
 Oftalmologia Instrumentos  
 Ophtalmologie Instruments  
 Oftalmologia Strumenti

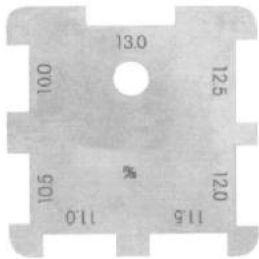

**67-932-01**  
**Stahl Corneal Caliper**  
 Measures 10.0 mm to 13.0 mm  
 With 0.5 mm Increments

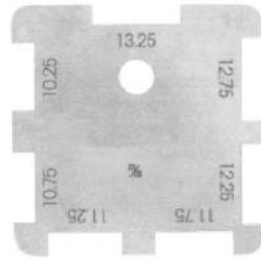

**67-932-02**  
**Stahl Corneal Caliper**  
 Measures 10.25 mm to 13.25 mm  
 With 0.5 mm Increments



**67-934-30**  
**Braunstein Caliper**  
 Double Ended Fixed Caliper  
 For 3.0 and 3.5 mm Marking



**67-934-35**  
**Braunstein Caliper**  
 Double Ended Fixed Caliper  
 For 3.5 and 4.0 mm Marking



**67-935-01**  
**Schioetz Tonometer**  
 Inclined Scale  
 With 5.5, 7.5 & 10 Grams Weights



**67-941-01**  
**Harms Trabeculotomy Probe**  
 Right, Two 10 mm Long Tips  
 With 3 mm Spread  
 Overall Length 5 cm (2")



**67-941-02**  
**Harms Trabeculotomy Probe**  
 Left, Two 10 mm Long Tips  
 With 3 mm Spread  
 Overall Length 5 cm (2")

Ophthalmology Instruments  
 Ophthalmologie Instrumente  
 Oftalmología Instrumentos  
 Ophthalmologie Instrumente  
 Oftalmologia Strumenti



**67-944-08**  
**Infant Lacrimal Dilator**  
 Ø 0.4 mm Very Fine 21 mm Long Blunt Tip  
 Overall Length 8 cm (3")



**67-946-10**  
**Muldoon Lacrimal Dilator**  
 Ø 0.35 mm Cylindrical Tip, With 27 mm Long Taper  
 Overall Length 10 cm (4")



**67-948-01**  
**Wilder Lacrimal Dilator**  
 Fig. 1, Fine, Tapered  
 Ø 0.32 mm / 32 mm Long Point  
 Overall Length 10.5 cm (4 1/4")



**67-948-02**  
**Wilder Lacrimal Dilator**  
 Fig. 2, Medium, Tapered  
 Ø 0.75 mm / 23 mm Long Point  
 Overall Length 10.5 cm (4 1/4")



**67-948-03**  
**Wilder Lacrimal Dilator**  
 Fig. 3, Long, Tapered  
 Ø 1.1 mm / 19 mm Long Point  
 Overall Length 10.5 cm (4 1/4")

Ophthalmology Instruments  
Ophthalmologie Instrumente  
Oftalmologia Instrumentos  
Ophtalmologie Instruments  
Oftalmologia Strumenti



**67-950-14**

**Castroviejo Lacrimal Dilator**

Double Ended, One Fine Tapered (Ø 0.32 mm / 32 mm Long) and One Medium Tapered (Ø 0.75 / 23 mm Long) Points



**67-953-14**

**Worst Pigtail Probe**

Double Ended, 8.0 mm Curved Blunt Probe With Eye Holes  
Overall Length 16 cm (6 ¼")



**67-956-14**

**Crawford Retrieval Hook**

Designed to Pick The Crawford Probe  
Overall Length 14.5 cm (5 ¾")



**67-960-00**

**Crawford Lacrimal Intubation Set**

Including Silicone Tube and Two Olive Tip Probes Ø 0.6 mm  
Probes Length 11 cm (4¼") Tube Length 30.5 cm (12")



Scalpel Handles, Scalpel Blades  
 Skalpgriffe, Skalpellklingen  
 Mangos de bisturíes, Hojas de bisturíes  
 Manches pour bistouris, Lames pour bistouris  
 Manici per bisturi, Lame per bisturi



**75-010-03**  
**Bard-Parker Scalpel Handle # 3**  
 Solid  
 Overall Length 12 cm (4 3/4")



**75-012-03**  
**Bard-Parker Scalpel Handle # 3**  
 Solid, CM Graduation  
 Overall Length 12 cm (4 3/4")



**75-100-11**  
**Scalpel Blade # 11**  
 Pack of 100  
 Fig. 11

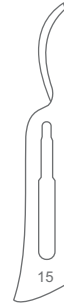

**75-100-15**  
**Scalpel Blade # 15**  
 Pack of 100  
 Fig. 15



**Scalpel Handle**  
 For Micro Scalpel Blades

- 75-206-10**  
10 cm (4")
- 75-206-13**  
13 cm (5")
- 75-206-15**  
15 cm (6")



**75-210-61**  
**Scalpel Handle # 3**  
 Fig. 61  
 Pack of 25



**75-210-62**  
 Fig. 62



**75-210-63**  
 Fig. 63



**75-210-64**  
 Fig. 64



**75-210-65**  
 Fig. 65



**75-210-66**  
 Fig. 66



**75-210-67**  
 Fig. 67



**75-210-68**  
 Fig. 68



**75-210-69**  
 Fig. 69

Blade Holders / Blade Breakers  
 Klingenthaler / Kingenbrecher  
 Porta-hojas / Rompe-hojas de afeitár  
 Pincettes pour saisir et casser les lames de rasoir  
 Pinze per afferrare e rompere le lamette de rasoio

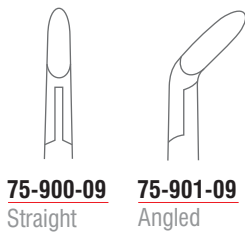

**75-900-09**  
Straight

**75-901-09**  
Angled

**Troutman-Chris Blade Holder/Breaker**  
 Round Handle  
 Overall Length 9 cm (3 1/2")



**75-100-15**  
**Barraquer Blade Holder/Breaker**  
 Overall Length 11 cm (4 1/4")



**75-916-13**  
**Barraquer Blade Holder/Breaker**  
 Round Handle  
 Overall Length 13 cm (5")

Dissecting Scissors, Gum Scissors, Iris Scissors  
 Präparierscheren, Zahnfleischscheren, Irisscheren  
 Tijeras de disección, Tijeras para encías, Tijeras para iridectomía  
 Ciseaux à dissection, Ciseaux à gencives, Ciseaux à iridectomie  
 Forbici per dissezione, Forbici per gengi, Forbici per iridectomia



**Ragnell (Kilner) Dissecting Scissor**

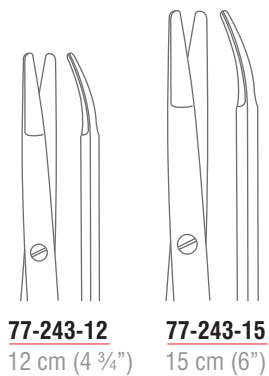

**77-243-12**  
12 cm (4 3/4")

**77-243-15**  
15 cm (6")

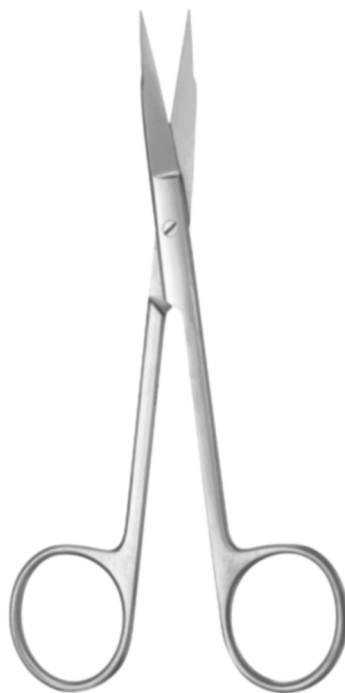

**Goldman-Fox Gum Scissor**  
Overall Length 13 cm (5")

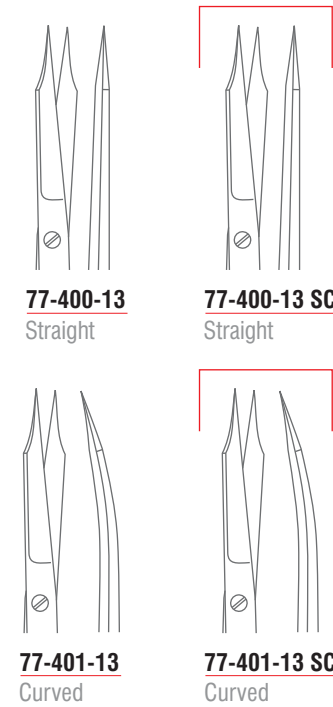

**77-400-13**  
Straight

**77-400-13 SC**  
Straight

**77-401-13**  
Curved

**77-401-13 SC**  
Curved

**SUPER**Edge™



**Iris Scissor**

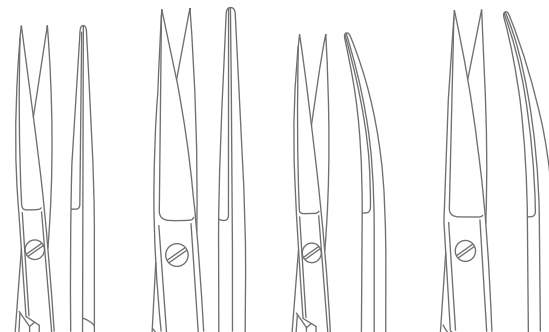

**77-430-09**  
Straight  
9 cm (3 1/2")

**77-430-10**  
Straight  
10 cm (4")

**77-431-09**  
Curved  
9 cm (3 1/2")

**77-431-10**  
Curved  
10 cm (4")

Iris Scissors  
 Irisscheren  
 Tijeras para iridectomía  
 Ciseaux à iridectomie  
 Forbici per iridectomia

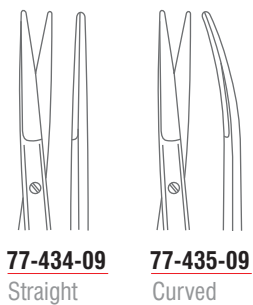

**Bonn Iris Scissor**  
 Overall Length 9 cm (3 1/2")

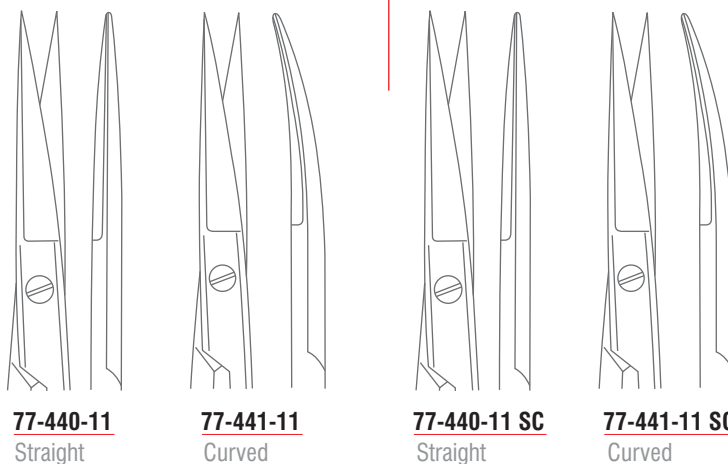

**Iris Scissor**  
 Overall Length 11.5 cm (4 1/2")

Iris Scissors  
 Irisscheren  
 Tijeras para iridectomía  
 Ciseaux à iridectomie  
 Forbici per iridectomia

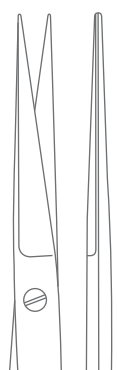

**77-446-12**  
Straight



**77-447-12**  
Curved

**Iris Scissor**  
Overall Length 12.5 cm (5")

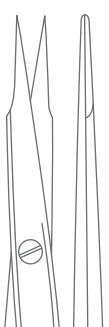

**77-450-10**  
Straight  
Sharp/Sharp  
10 cm (4")



**77-450-11**  
Straight  
Sharp/Sharp  
11 cm (4 1/2")



**77-451-10**  
Curved  
Sharp/Sharp  
10 cm (4")



**77-451-11**  
Curved  
Sharp/Sharp  
11 cm (4 1/2")

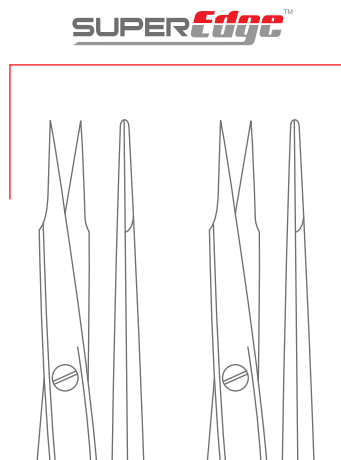

**77-450-11 SC**  
Straight  
Sharp/Sharp  
11 cm (4 1/2")

**77-451-11 SC**  
Curved  
Sharp/Sharp  
11 cm (4 1/2")

**Stevens Tenotomy Scissor**

**SUPEREdge™**

Dissecting Scissors  
 Präparierscheren  
 Tijeras de disección  
 Ciseaux à dissection  
 Forbici per dissezione

**SUPER**Edge™



**Stevens Tenotomy Scissor**



**77-452-10**  
 Straight  
 Blunt/Blunt  
 10 cm (4")

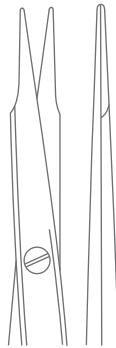

**77-452-11**  
 Straight  
 Blunt/Blunt  
 11 cm (4 1/2")

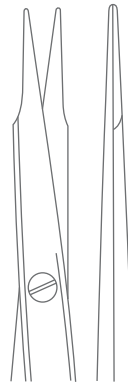

**77-452-12**  
 Straight  
 Blunt/Blunt  
 12.5 cm (5")

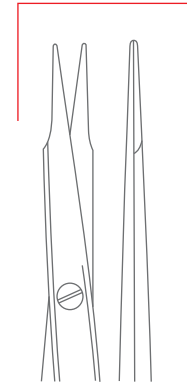

**77-452-11 SC**  
 Straight  
 Blunt/Blunt  
 11 cm (4 1/2")



**77-453-10**  
 Curved  
 Blunt/Blunt  
 10 cm (4")



**77-453-11**  
 Curved  
 Blunt/Blunt  
 11 cm (4 1/2")



**77-453-11**  
 Curved  
 Blunt/Blunt  
 12.5 cm (5")

Strabismus Scissors  
Strabismusscheren  
Tijeras para estrabismo  
Ciseaux à strabisme  
Forbici per strabismo



**Strabismus Scissor**  
Overall Length 11.5 cm (4 1/2")

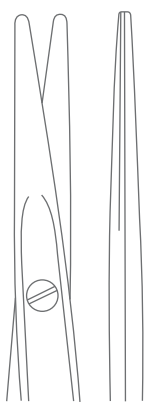

**77-456-11**  
Straight



**77-457-11**  
Curved

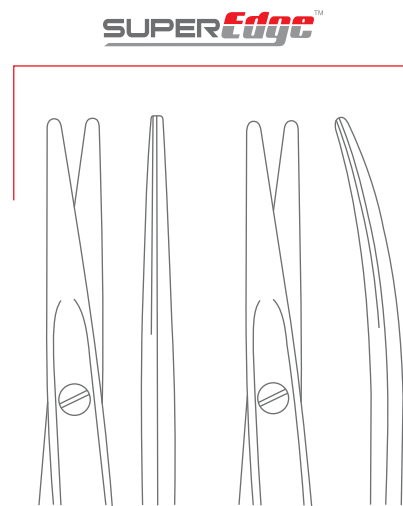

**77-456-11 SC**  
Straight

**77-457-11 SC**  
Curved

Dissecting Scissors  
 Präparierscheren  
 Tijeras de disección  
 Ciseaux à dissection  
 Forbici per dissezione



77-461-11

**Little Dissecting Scissor**  
 Curved, Tip With Eye For Suture  
 Overall Length 11.5 cm (4 ½")



77-466-11  
 Straight

**Kilner Delicate Dissecting Scissor**  
 Overall Length 11.5 cm (4 ½")



Enucleation Scissors  
 Enukleationsschere  
 Tijeras de enucleación  
 Ciseaux d'enucléation  
 Forbici per enucleazione

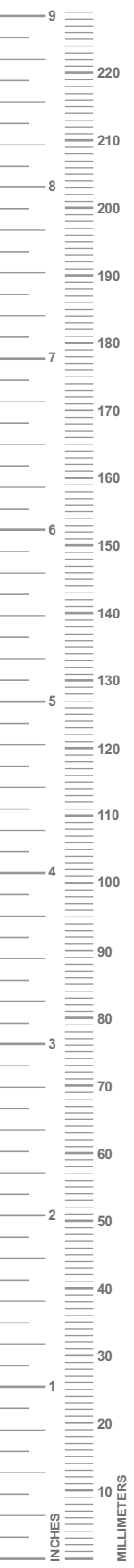

**77-469-11**  
Curved

**Enucleation Scissor**  
Overall Length 11.5 cm (4 1/2")

Ribbon Ophthalmic Scissors  
Band-Augenschere  
Tijera oftálmica de cinta  
Ciseaux ophtalmiques à ruban  
Forbici oftalmica a nastro



**77-484-09**  
**Salyer Ribbon Scissor**  
Straight, Flat Shanks  
Overall Length 9.5 cm (3 3/4")



**Iris Scissor (Ribbon Type)**  
Overall Length 9.5 cm (3 3/4")

**77-486-09**  
Straight, Sharp, Flat Shanks

**77-487-09**  
Curved, Sharp, Flat Shanks



**Iris Scissor (Ribbon Type)**  
Overall Length 10 cm (4")

**77-488-10**  
Straight, Blunt, Flat Shanks

**77-489-10**  
Curved, Blunt, Flat Shanks



**Strabismus Scissor (Ribbon Type)**  
Overall Length 10 cm (4")

**77-492-10**  
Straight, Flat Shanks

**77-493-10**  
Curved, Flat Shanks

Ribbon Ophthalmic Scissors  
Band-Augenschere  
Tijera oftálmica de cinta  
Ciseaux ophtalmiques à ruban  
Forbici oftalmica a nastro



**Stevens Tenotomy Scissor (Ribbon Type)**  
Overall Length 10 cm (4")

**77-496-10**

Straight, Flat Shanks, Sharp Tips

**77-497-10**

Curved, Flat Shanks, Sharp Tips

**77-498-10**

Straight, Flat Shanks, Blunt Tips

**77-499-10**

Curved, Flat Shanks, Blunt Tips



**Gradle Scissor (Ribbon Type)**  
Overall Length 10 cm (4")

**77-500-10**

Straight, Flat Shanks

**77-501-10**

Curved, Flat Shanks

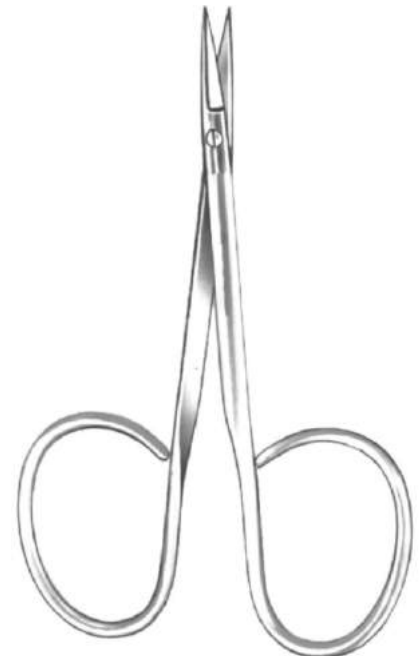

**77-507-11**

**Kaye Facelift Scissor (Ribbon Type)**

Curved, Flat Shanks, Toothed  
Overall Length 11 cm (4 ½")



Micro Scissors  
Mikroscheren  
Micro-Tijeras  
Micro-Ciseaux  
Micro-Forbici



**77-626-01**  
**Williamson-Noble Micro Scissor**  
Straight, Sharp/Sharp 27 mm Long Blades With  
Max. 14 mm Cutting Edge  
Overall Length 11.5 cm (4 3/4")



**Noyes Iris Scissor**  
Sharp/Sharp, 23 mm Long Blades With  
Max. 14 mm Cutting Edge  
Overall Length 12.5 cm (5")



**77-630-12**  
Straight

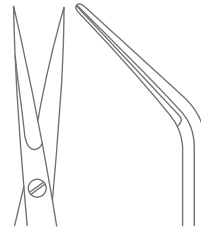

**77-631-12**  
Curved

Micro Scissors  
Mikroscheren  
Micro-Tijeras  
Micro-Ciseaux  
Micro-Forbici



**77-632-12**  
Straight

**Noyes Iris Scissor**  
Sharp/Blunt  
23 mm Long Blades With  
Max. 14 mm Cutting Edge  
Overall Length 12.5 cm (5")

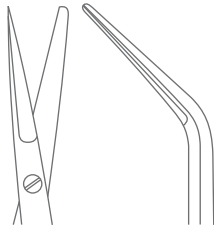

**77-633-12**  
Curved



**77-634-12**  
Straight

**Noyes Iris Scissor**  
Blunt/Blunt  
23 mm Long Blades With  
Max. 14 mm Cutting Edge  
Overall Length 12.5 cm (5")

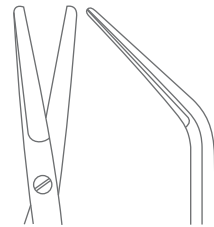

**77-635-12**  
Curved

Micro Scissors  
Mikroscheren  
Micro-Tijeras  
Micro-Ciseaux  
Micro-Forbici



**77-636-12**  
Straight



**77-637-12**  
Curved

**Micro Scissor**

13 mm Long Blades

Max. With 10 mm Cutting Edge

Overall Length 12 cm (4 3/4")

Micro Scissors  
Mikroscheren  
Micro-Tijeras  
Micro-Ciseaux  
Micro-Forbici



**Wecker Iris Scissor**

8 mm Long Blades With Max. 5 mm Cutting Edge  
Overall Length 11 cm (4 1/2")

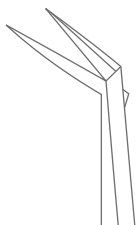

**77-641-11**  
Angled, Sharp/Sharp

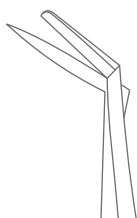

**77-643-11**  
Angled, Sharp/Blunt

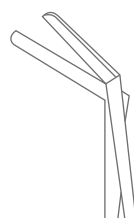

**77-645-11**  
Angled, Blunt/Blunt



**Barraquer Iris Scissor**

9 mm Long Blades Max. 6 mm Cutting Edge  
Overall Length 5.5 cm (2 1/4")

**77-647-05**  
Angled, 5 mm

**77-647-07**  
Angled, 7 mm

**77-647-10**  
Angled, 10 mm

Micro Scissors  
 Mikroscheren  
 Micro-Tijeras  
 Micro-Ciseaux  
 Micro-Forbici



**77-649-01**  
 Curved Right



**77-649-02**  
 Curved Left

**Holland DALK Scissor**  
 Blunt Tips With Spatulated Inner Blade  
 8 mm Long Blades With  
 Max. 4 mm Cutting Edge  
 Overall Length 10.5 cm (4")



**Castroviejo Corneoscleral Scissor**  
 8 mm Long Blades With  
 Max. 4 mm Cutting Edge  
 Overall Length 10.5 cm (4")

**77-651-01**  
 Curved Right

**77-651-02**  
 Curved Left

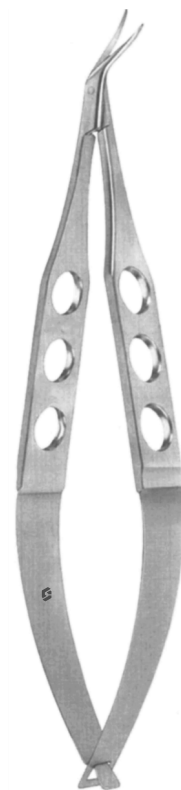

**Castroviejo Corneoscleral Scissor**  
 12 mm Long Blades With  
 Max. 7 mm Cutting Edge  
 Overall Length 11 cm (4")

**77-653-01**  
 Curved Right

**77-653-02**  
 Curved Left





Micro Scissors  
Mikroscheren  
Micro-Tijeras  
Micro-Ciseaux  
Micro-Forbici



**Troutman-Castroviejo Corneoscleral Scissor**  
With Lock  
8 mm Long Blades With  
Max. 4 mm Cutting Edge  
Overall Length 10.5 cm (4")

**77-655-01**  
Curved Right  
**77-655-02**  
Curved Left



**Troutman-Castroviejo Corneoscleral Scissor**  
With Lock  
12 mm Long Blades With  
Max. 7 mm Cutting Edge  
Overall Length 11 cm (4 1/2")

**77-657-01**  
Curved Right  
**77-657-02**  
Curved Left

Micro Scissors  
Mikroscheren  
Micro-Tijeras  
Micro-Ciseaux  
Micro-Forbici



**Troutman-Katzin Corneal Transplant Scissor**

Strongly Curved, With Lock  
8 mm Long Blades With  
Max. 4 mm Cutting Edge  
Overall Length 10.5 cm (4")

**77-659-01**

Curved Right

**77-659-02**

Curved Left



**Katzin Corneal Transplant Scissor**

Strongly Curved  
13 mm Long Blades With  
Max. 7 mm Cutting Edge  
Overall Length 11 cm (4 ½")

**77-661-01**

Curved Right

**77-661-02**

Curved Left



Micro Scissors  
Mikroscheren  
Micro-Tijeras  
Micro-Ciseaux  
Micro-Forbici



**Castroviejo Universal Corneal Scissor**

Curved, Blunt Tips  
Overall Length 11 cm (4 1/2")

**77-663-11**

10 mm Long Blades With  
Max. 5 mm Cutting Edge

**77-665-11**

12 mm Long Blades With  
Max. 6 mm Cutting Edge

**77-667-11**

14 mm Long Blades With  
Max. 8 mm Cutting Edge



**77-669-11**

**Castroviejo Universal Corneal Scissor**

Strongly Curved, Blunt Tips 15 mm Long Blades With  
Max. 9 mm Cutting Edge  
Overall Length 11.5 cm (4 1/2")

Micro Scissors  
Mikroscheren  
Micro-Tijeras  
Micro-Ciseaux  
Micro-Forbici

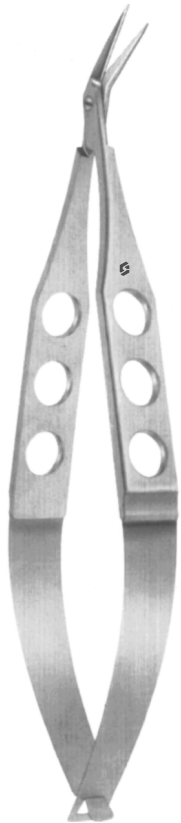

**77-671-11**  
**Castroviejo Keratoplasty Scissor**  
Angled to Side, Blunt Tips  
14 mm Long Blades With  
Max. 9 mm Cutting Edge  
Overall Length 11.5 cm (4 ½")



**77-673-11**  
**McPherson-Westcott Conjunctival Scissor**  
Curved, Blunt Tips  
10 mm Long Blades With  
Max. 5 mm Cutting Edge  
Overall Length 11 cm (4 ½")



**77-675-11**  
**Westcott Tenotomy Scissor**  
Curved, Blunt Tips  
14 mm Long Blades With  
Max. 8 mm Cutting Edge  
Overall Length 11 cm (4 ½")

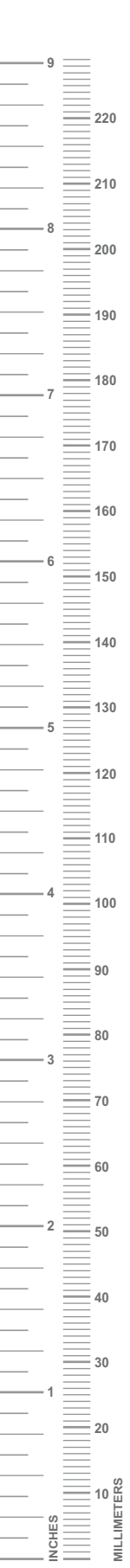

Micro Scissors  
Mikroscheren  
Micro-Tijeras  
Micro-Ciseaux  
Micro-Forbici



**Westcott Tenotomy Scissor**  
Blunt Tips  
20 mm Long Blades With  
Max. 10 mm Cutting Edge  
Overall Length 11 cm (4 1/2")

**77-677-01**  
Curved Right  
**77-677-02**  
Curved Left



**77-679-11**  
**Tibolt Punctal Scissor**  
One Conically Shaped Blade With  
Micro Grooves & Textured Surface  
15 mm Long Blades With  
Max. 8 mm Cutting Edge  
Overall Length 11.5 cm (4 1/2")



**77-681-11**  
**McPherson-Westcott Stitch Scissor**  
Curved, Very Sharp Pointed Tips, Small Blades  
10 mm Long Blades With  
Max. 5 mm Cutting Edge  
Overall Length 11 cm (4 1/2")

Micro Scissors  
 Mikroscheren  
 Micro-Tijeras  
 Micro-Ciseaux  
 Micro-Forbici



**77-683-11**  
**Westcott Stitch Scissor**  
 Curved, Very Sharp Pointed Tips  
 20 mm Long Blades With  
 Max. 10 mm Cutting Edge  
 Overall Length 11.5 cm (4 ½")



**77-685-11**  
**Jaffe Stitch Scissor**  
 Curved, Very Sharp Pointed Tips  
 13 mm Long Blades With  
 Max. 7 mm Cutting Edge  
 Overall Length 11 cm (4 ½")



**77-688-11**  
**Iris Micro Scissor**  
 Straight, Sharp Tips  
 10 mm Long Blades With  
 Max. 5 mm Cutting Edge  
 Overall Length 11 cm (4 ½")



**77-689-11**  
**Iris Micro Scissor**  
 Curved, Sharp Tips  
 10 mm Long Blades With  
 Max. 5 mm Cutting Edge  
 Overall Length 11 cm (4 ½")



Micro Scissors  
Mikroscheren  
Micro-Tijeras  
Micro-Ciseaux  
Micro-Forbici



**77-690-11**  
**Fine Micro Scissor**  
Straight, Sharp Tips  
17 mm Long Blades With  
Max. 9 mm Cutting Edge  
Overall Length 11.5 cm (4 1/2")



**77-691-11**  
**Fine Micro Scissor**  
Curved, Sharp Tips  
17 mm Long Blades With  
Max. 9 mm Cutting Edge  
Overall Length 11.5 cm (4 1/2")



**77-694-08**  
**Vannas Capsulotomy Scissor**  
Straight, Sharp Tips  
5 mm Long Blades With  
Max. 3 mm Cutting Edge  
Overall Length 8 cm (3 1/4")



**77-695-08**  
**Vannas Capsulotomy Scissor**  
Curved, Sharp Tips  
5 mm Long Blades With  
Max. 3 mm Cutting Edge  
Overall Length 8 cm (3 1/4")

Micro Scissors  
Mikroscheren  
Micro-Tijeras  
Micro-Ciseaux  
Micro-Forbici



**77-696-08**

**Vannas Capsulotomy Scissor**

Angled Forward, Sharp Tips 5 mm Long Blades With  
Max. 3 mm Cutting Edge  
Overall Length 8 cm (3 1/4")



**77-697-08**

**Vannas Capsulotomy Scissor**

Angled to Side, Sharp Tips 5 mm Long Blades With  
Max. 3 mm Cutting Edge  
Overall Length 8 cm (3 1/4")



**77-698-08**

**Gills-Vannas Capsulotomy Scissor**

Straight, Sharp Tips 7 mm Long Blades With  
Max. 3 mm Cutting Edge  
Overall Length 8 cm (3 1/4")



**77-699-08**

**Gills-Vannas Capsulotomy Scissor**

Curved, Sharp Tips 7 mm Long Blades With  
Max. 3 mm Cutting Edge  
Overall Length 8 cm (3 1/4")





Micro Scissors  
 Mikroscheren  
 Micro-Tijeras  
 Micro-Ciseaux  
 Micro-Forbici



**77-701-08**  
**Gills-Vannas Capsulotomy Scissor**  
 Angled Forward, Sharp Tips 7 mm  
 Long Blades With Max. 3 mm  
 Cutting Edge  
 Overall Length 8 cm (3 1/4")



**77-703-08**  
**McPherson-Vannas Capsulotomy Scissor**  
 Curved, Sharp Tips 8 mm  
 Long Blades With  
 Max. 3 mm Cutting Edge  
 Overall Length 8 cm (3 1/4")



**77-705-08**  
**Holland DALK Scissor**  
 Angled Blades With Blunt Tips  
 5 mm Long Blades With  
 Max. 3 mm Cutting Edge  
 Overall Length 8 cm (3 1/4")

Micro Scissors  
Mikroscheren  
Micro-Tijeras  
Micro-Ciseaux  
Micro-Forbici



**77-706-10**  
**Gills-Vannas Micro Scissor**  
Straight, Extra Thin Blades  
Sharp Tips  
7 mm Long Blades With  
Max. 3 mm Cutting Edge  
Overall Length 10.5 cm (4")



**77-707-10**  
**Gills-Vannas Micro Scissor**  
Curved, Extra Thin Blades  
Sharp Tips  
7 mm Long Blades With  
Max. 3 mm Cutting Edge  
Overall Length 10.5 cm (4")



**77-709-10**  
**Gills-Vannas Micro Scissor**  
Angled Forward, Extra Thin Blades  
Sharp Tips  
7 mm Long Blades With  
Max. 3 mm Cutting Edge  
Overall Length 10.5 cm (4")

Micro Scissors  
Mikroscheren  
Micro-Tijeras  
Micro-Ciseaux  
Micro-Forbici



**77-710-11**  
**Stern-Gills Micro Scissor**  
Straight, Extra Thin Blades  
Sharp Tips  
10 mm Long Blades With  
Max. 4 mm Cutting Edge  
Overall Length 11 cm (4 1/2")



**77-711-11**  
**Stern-Gills Micro Scissor**  
Curved, Extra Thin Blades  
Sharp Tips  
10 mm Long Blades With  
Max. 4 mm Cutting Edge  
Overall Length 11 cm (4 1/2")



**77-713-11**  
**Stern-Gills Micro Scissor**  
Angled Forward, Extra Thin Blades  
Sharp Tips  
10 mm Long Blades With  
Max. 4 mm Cutting Edge  
Overall Length 11 cm (4 1/2")



**77-715-11**  
**Gills Capsulotomy Scissor**  
Angled Blades With Curved Sharp Tips  
10 mm Long Blades With  
Max. 4 mm Cutting Edge  
Overall Length 10.5 cm (4 1/2")

Micro Scissors  
Mikroscheren  
Micro-Tijeras  
Micro-Ciseaux  
Micro-Forbici

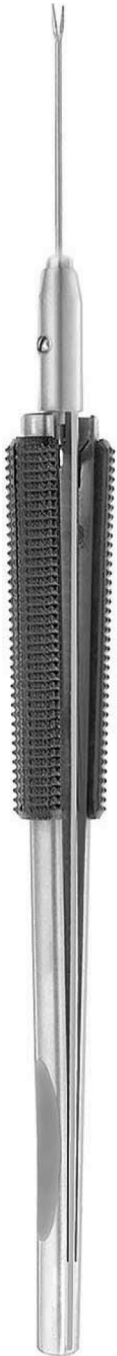

**77-720-20**  
Straight, Horizontal Opening 20 G



**77-721-20**  
Curved, Horizontal Opening 20 G  
**77-721-23**  
Curved, Horizontal Opening 23 G



**77-721-30**  
Angled 30°, Horizontal Opening  
20 G



**77-721-45**  
Angled 45°, Horizontal Opening  
20 G



**77-723-23**  
Vertical Straight, 23 G



**77-723-60**  
Angled 60°, Horizontal Opening, 20 G



**77-723-80**  
Angled 80°, Horizontal Opening, 20 G

**Vitrectomy Scissor**  
Overall Length 14 cm (5 1/2")



Micro Scissors  
Mikroscheren  
Micro-Tijeras  
Micro-Ciseaux  
Micro-Forbici



**77-725-23**  
**Alio MICS Scissor**  
 Curved, 23 G  
 Shaft With Horizontal Micro Blades for Cutting Delicate Membranes  
 Overall Length 14 cm (5 1/2")

Micro Scissors  
 Mikroscheren  
 Micro-Tijeras  
 Micro-Ciseaux  
 Micro-Forbici



**77-726-12**  
**Vannas Micro Scissor**  
 Straight, 10 mm Long Blades With  
 Max. 4 mm Cutting Edge  
 Overall Length 12 cm (4 3/4")



**77-727-12**  
**Vannas Micro Scissor**  
 Curved, 10 mm Long Blades With  
 Max. 4 mm Cutting Edge  
 Overall Length 12 cm (4 3/4")



**77-729-12**  
**Vannas Micro Scissor**  
 Angled on Flat, 10 mm Long Blades With  
 Max. 4 mm Cutting Edge  
 Overall Length 12 cm (4 3/4")



**UltraCut™ TC Stevens Tenotomy Scissor**  
 Overall Length 10.5 cm (4 1/4")



**77-972-10**  
 Straight  
 Blunt/Blunt



**77-973-10**  
 Curved  
 Blunt/Blunt



**77-974-10**  
 Straight  
 Sharp/Sharp



**77-975-10**  
 Straight  
 Sharp/Sharp



Dissecting Forceps  
Anatomische Pinzetten  
Pinzas de disección  
Pinces à dissection  
Pinze per dissezione



**Adson Dressing Forcep**  
Serrated Tip

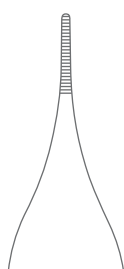

**37-050-12**  
12 cm (4 3/4")

**37-050-15**  
15 cm (6")

**37-050-18**  
18 cm (7")



**Mini-Adson Dressing Forcep**  
Overall Length 12 cm (4 3/4")



**37-052-12**  
Cross Serrated Tip

Dissecting Forceps  
Anatomische Pinzetten  
Pinzas de disección  
Pincès à dissection  
Pinze per dissezione

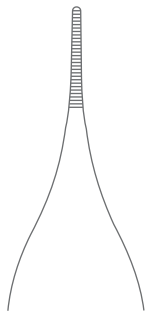

**37-054-12**  
12 cm (4 3/4")

**37-054-15**  
15 cm (6")

**Micro-Adson Dressing Forcep**  
Cross Serrated Tip

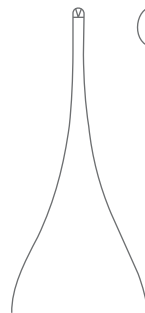

**37-250-12**  
12 cm (4 3/4")

**37-250-15**  
15 cm (6")

**37-250-18**  
18 cm (7")

**Adson Dissecting Forcep**  
1 x 2 Teeth



Dissecting Forceps  
Anatomische Pinzetten  
Pinzas de disección  
Pinces à dissection  
Pinze per dissezione

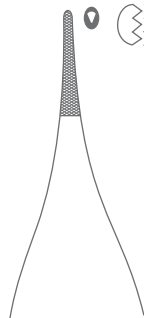

**37-252-12**  
Straight

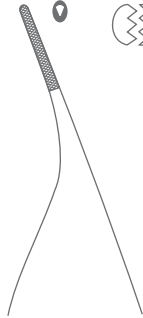

**37-253-12**  
Curved

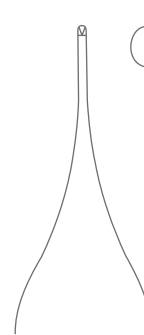

**37-256-12**  
12 cm (4 3/4")

**37-256-15**  
15 cm (6")

**Mini-Adson Dissecting Forcep**  
1 x 2 Teeth, Cross Serrated  
Overall Length 12 cm (4 3/4")

**Micro-Adson Dissecting Forcep**  
1 x 2 Teeth

Cilia Forceps  
Zilienzange  
Pinzas para cilios  
Pincers à cils  
Pinze Cilia



**37-630-09**  
Smooth Jaws

**Beer Cilia Forcep**  
Overall Length 9 cm (3 1/2")



**37-632-10**  
Smooth Jaws

**Barraquer Cilia Forcep**  
Overall Length 10 cm (4")



Micro Forceps  
Mikropinzetten  
Micro Pinzas  
Micro-Pinces  
Micro-Pinze



**Vitrectomy Forcep**  
14 cm (5 1/2")



**37-680-20**  
Straight, Serrated Tip 20 G

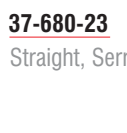

**37-680-23**  
Straight, Serrated Tip 23 G



**37-687-20**  
Membrane Peeling, Smooth  
45°Angled Jaws, 20 G



**37-682-20**  
Straight, End Grasping Jaws  
Horizontal Opening Tip 20 G

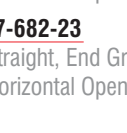

**37-682-23**  
Straight, End Grasping Jaws  
Horizontal Opening Tip 23 G



**37-689-23**  
Asymmetrical Jaws 23 G



**37-685-20**  
Smooth Side, Gripping Jaws  
Vertical Opening Tip 20 G



**37-690-23**  
ILM 23 G

Micro Forceps  
Mikropinzetten  
Micro Pinzas  
Micro-Pinces  
Micro-Pinze



**37-692-20**  
**ICL Lens Cartridge Loading Forcep**  
Straight, 20 G  
Jaws Feature a Series of Concave  
and Convex Surfaces

ICL® is a registered trademark of  
STAAR Surgical Company



**37-695-23**  
**Alio MICS Capsulorhexis Forcep**  
23 G, Curved Shaft With Short Micro-Grasping  
Tip Designed For Use Through a Very Small Paracentesis.

Eye Surgery Forceps  
 Augen Chirurgie Pinzetten  
 Ojo Pinzas Cirugía  
 Pince de chirurgie oculaire  
 Eye Pinze Chirurgia



**37-700-01**  
 Straight  
 10 cm (4")

**Graefe Eye Dressing Forcep**  
 Serrated Tips



**37-700-02**  
 Gently Curved  
 10 cm (4")



**37-700-03**  
 Strongly Curved  
 9.5 cm (3 3/4")



**Graefe Dissecting Forcep**  
 1 x 2 Teeth



**37-702-01**  
 Straight  
 10 cm (4")



**37-702-02**  
 Gently Curved  
 10 cm (4")



**37-702-03**  
 Strongly Curved  
 9.5 cm (3 3/4")

Eye Surgery Forceps  
 Augen Chirurgie Pinzetten  
 Ojo Pinzas Cirugia  
 Pince de chirurgie oculaire  
 Eye Pinze Chirurgia



**37-710-07**  
**Botvin Iris Forcep**  
 Serrated  
 Overall Length 7.5 cm (3 1/4")



**37-712-07**  
**Botvin Iris Forcep**  
 1 x 2 Teeth  
 Overall Length 7.5 cm (3 1/4")



**37-714-07**  
**Gills-Colibri Corneal Forcep**  
 Very Fine Pointed Tip, With Tying Platform  
 Overall Length 7.5 cm (3 1/4")



**37-716-07**  
**Colibri Corneal Forcep**  
 Very Delicate, 1 x 2 Teeth, 0.12 mm  
 Overall Length 7.5 cm (3 1/4")



**37-718-07**  
**Harms-Colibri Corneal Forcep**  
 Very Delicate, 1 x 2 Teeth, 0.12 mm  
 With Tying Platform  
 Overall Length 7.5 cm (3 1/4")



**37-718-07 T**  
**Harms-Colibri Corneal Forcep**  
 Very Delicate, 1 x 2 Teeth, 0.12 mm  
 With Tying Platform  
 Overall Length 7.5 cm (3 1/4")



TITANIUM

Eye Surgery Forceps  
Augenchirurgie Pinzetten  
Ojo Pinzas Cirugía  
Pince de chirurgie oculaire  
Eye Pinze Chirurgia



**37-720-07**  
**Colibri Corneal Forcep**  
Standard 1 x 2 Teeth  
With Tying Platform, 0.4 mm  
Overall Length 7.5 cm (3 1/4")



**37-721-07**  
**Pierce-Colibri Corneal Forcep**  
1 x 1 Teeth, 0.12 mm  
Overall Length 7.5 cm (3 1/4")



**37-722-08**  
**Hoskin Tissue Forcep**  
Straight, 1 x 1 Teeth  
Overall Length 8 cm (3 1/4")



**37-723-08**  
**Hoskin Tissue Forcep**  
Curved, 1 x 1 Teeth  
Overall Length 8 cm (3 1/4")

Eye Surgery Forceps  
 Augen Chirurgie Pinzetten  
 Ojo Pinzas Cirugia  
 Pince de chirurgie oculaire  
 Eye Pinze Chirurgia



**37-724-10**  
**Fechtner Conjunctival Forcep**  
 Very Delicate Ring Shaped Tips  
 With Tying Platform  
 Overall Length 10.5 cm (4")



**37-726-11**  
**Castroviejo-Colibri Corneal Forcep**  
 Very Delicate 1 x 2 Teeth, 0.12 mm  
 Overall Length 11 cm (4 1/4")



**37-728-11**  
**Harms-Colibri Corneal Forcep**  
 Very Delicate 1 x 2 Teeth, 0.12 mm  
 With Tying Platform  
 Overall Length 11 cm (4 1/4")



Eye Surgery Forceps  
 Augen Chirurgie Pinzetten  
 Ojo Pinzas Cirugia  
 Pince de chirurgie oculaire  
 Eye Pinze Chirurgia

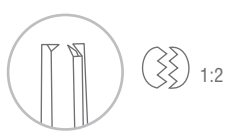

**37-730-08**  
**Bonn Corneal Forcep**  
 Very Delicate 1 x 2 Teeth 0.12 mm  
 Overall Length 8.5 cm (4")



**37-732-10**  
**Bonn Corneal Forcep**  
 Very Delicate 1 x 2 Teeth  
 With Tying Platform, 0.12 mm  
 Overall Length 10 cm (4")



**37-732-10 T**  
**Bonn Corneal Forcep**  
 Very Delicate 1 x 2 Teeth  
 With Tying Platform, 0.12 mm, Titanium  
 Overall Length 10 cm (4")



**37-734-08**  
**Bonn Corneal Forcep**  
 Very Delicate, Serrated  
 Overall Length 8.5 cm (3 1/4")

Eye Surgery Forceps  
 Augenchirurgie Pinzetten  
 Ojo Pinzas Cirugia  
 Pince de chirurgie oculaire  
 Eye Pinze Chirurgia



**37-736-10**  
**McPherson Suture Tying Forcep**  
 Straight, 1 x 2 Teeth  
 With Tying Platform, 0.4 mm  
 Overall Length 10.5 cm (4")



**37-737-10**  
**McPherson Suture Tying Forcep**  
 Angled, 1 x 2 Teeth  
 With Tying Platform, 0.4 mm  
 Overall Length 10 cm (4")



**37-740-10**  
**Kelman-McPherson Tissue Forcep**  
 Angled, 1 x 2 Teeth  
 With Tying Platform, 0.3 mm  
 Overall Length 10 cm (4")

Eye Surgery Forceps  
 Augen Chirurgie Pinzetten  
 Ojo Pinzas Cirugía  
 Pince de chirurgie oculaire  
 Eye Pinze Chirurgia



**37-742-10**  
**Hoffer-McPherson Tissue Forcep**  
 Very Delicate, 1 x 2 Teeth  
 11 mm, 0.12 mm  
 Overall Length 10 cm (4")



**Castroviejo Suture Tying Forcep**  
 1 x 2 Teeth, With Tying Platform  
 Overall Length 11 cm (4 1/4")

- 37-750-01** 0.12 mm
- 37-750-03** 0.3 mm
- 37-750-05** 0.5 mm
- 37-750-09** 0.9 mm



**37-750-01 T**  
**Castroviejo Suture Tying Forcep**  
 1 x 2 Teeth, With Tying Platform  
 0.12 mm, Titanium  
 Overall Length 11 cm (4 1/4")

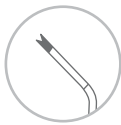
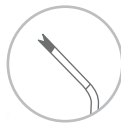

Eye Surgery Forceps  
 Augenchirurgie Pinzetten  
 Ojo Pinzas Cirugia  
 Pince de chirurgie oculaire  
 Eye Pinze Chirurgia

 1:2

 1:2

 1:2

**Castroviejo Suture Tying Forcep**

Angled, 1 x 2 Teeth  
 With Tying Platform  
 Overall Length 11 cm (4 1/4")

- 37-751-01** 0.12 mm
- 37-751-03** 0.3 mm
- 37-751-05** 0.5 mm
- 37-751-09** 0.9 mm

**37-751-01 T**

**Castroviejo Suture Tying Forcep**  
 Angled, 1 x 2 Teeth, With Tying Platform  
 0.12 mm, Titanium  
 Overall Length 11 cm (4 1/4")



TITANIUM

**37-752-05**

**Stern-Castroviejo Suture Tying Forcep**  
 1 x 2 Teeth, 0.5 mm  
 Overall Length 11 cm (4 1/4")



Eye Surgery Forceps  
 Augen Chirurgie Pinzetten  
 Ojo Pinzas Cirugía  
 Pince de chirurgie oculaire  
 Eye Pinze Chirurgia



**37-754-10**  
**Girard Corneoscleral Forcep**  
 1 x 2 Teeth With Tying Platform  
 For Right Hand, 0.12 mm  
 Overall Length 10.5 cm (4")



**37-756-10**  
**Girard Corneoscleral Forcep**  
 1 x 2 Teeth With Tying Platform  
 For Left Hand, 0.12 mm  
 Overall Length 10.5 cm (4")



**37-758-08**  
 0.3 mm Delicate  
 1 x 2 Teeth



**37-760-08**  
 0.8 mm Standard  
 1 x 2 Teeth



**Bishop-Harmon Iris Forcep**  
 Overall Length 8.5 cm (3 1/4")

Eye Surgery Forceps  
 Augenchirurgie Pinzetten  
 Ojo Pinzas Cirugia  
 Pince de chirurgie oculaire  
 Eye Pinze Chirurgia



**37-762-09**  
**Bishop-Harmon Dressing Forcep**  
 Cross Serrated Jaws  
 Overall Length 8.5 cm (3 ¼")



**37-764-09**  
**St. Martin's Suture Tying Forcep**  
 1 x 2 Teeth  
 With Tying Platform  
 Overall Length 9 cm (3 ½")



**37-765-09**  
**Paufique Suture Tying Forcep**  
 1 x 2 Teeth  
 With Tying Platform  
 Overall Length 9 cm (3 ½")



**37-766-09**  
**Sauer Fixation Forcep**  
 1 x 2 Teeth, 0.3 mm  
 Overall Length 9 cm (3 ½")

Eye Surgery Forceps  
 Augen Chirurgie Pinzetten  
 Ojo Pinzas Cirugía  
 Pince de chirurgie oculaire  
 Eye Pinze Chirurgia

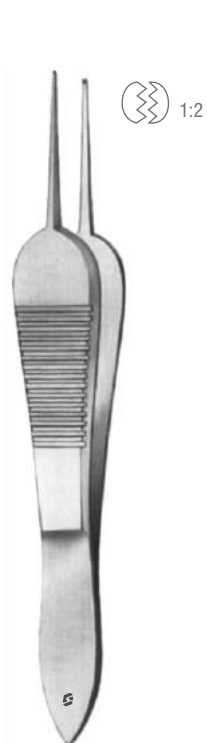

**37-768-09**  
**Manhattan Eye & Ear Fixation Forcep**  
 1 x 2 Teeth, 0.3 mm, With Tying Platform  
 Overall Length 9 cm (3 1/2")



**37-770-11**  
**Elschnig Fixation Forcep**  
 1 x 2 Teeth  
 Overall Length 11 cm (4 1/4")



**37-772-01**  
**Graefe Fixation Forcep**  
 Without Lock  
 Overall Length 11 cm (4 1/4")



**37-772-02**  
**Graefe Fixation Forcep**  
 With Lock  
 Overall Length 11 cm (4 1/4")

Eye Surgery Forceps  
Augenchirurgie Pinzetten  
Ojo Pinzas Cirugia  
Pince de chirurgie oculaire  
Eye Pinze Chirurgia



**37-774-10**  
**Green Fixation Forcep**  
9.0 mm  
Overall Length 10.5 cm (4")



**37-774-11**  
**Troutman Superior Rectus Forcep**  
Angled, 1 x 2 Teeth  
Overall Length 11 cm (4 1/4")



**Lester Fixation Forcep**  
Overall Length 9.5 cm (3 3/4")



**37-776-01**  
Angled  
1 x 2 Teeth



**37-776-02**  
Angled  
2 x 3 Teeth





Eye Surgery Forceps  
 Augenchirurgie Pinzetten  
 Ojo Pinzas Cirugía  
 Pince de chirurgie oculaire  
 Eye Pinze Chirurgia



**37-777-01**  
**Moody Fixation Forcep**  
 Curved Right  
 Overall Length 11 cm (4 1/4")



**37-777-02**  
**Moody Fixation Forcep**  
 Curved Left  
 Overall Length 11 cm (4 1/4")

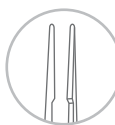

**37-780-10**  
**McPherson Suture Tying Forcep**  
 Straight, With Tying Platform, 5 mm  
 Overall Length 10 cm (4")



**37-780-10 T**  
**McPherson Suture Tying Forcep**  
 Straight, With Tying Platform, 5 mm  
 Titanium  
 Overall Length 10 cm (4")



Eye Surgery Forceps  
Augenchirurgie Pinzetten  
Ojo Pinzas Cirugia  
Pince de chirurgie oculaire  
Eye Pinze Chirurgia



**37-781-10**

**McPherson Suture Tying Forcep**  
Angled, With Tying Platform, 5 mm  
Overall Length 10 cm (4")



**37-781-10 T**

**McPherson Suture Tying Forcep**  
Angled, With Tying Platform, 5 mm Titanium  
Overall Length 10 cm (4")



Eye Surgery Forceps  
 Augen Chirurgie Pinzetten  
 Ojo Pinzas Cirugía  
 Pince de chirurgie oculaire  
 Eye Pinze Chirurgia



**37-784-10**  
**Kelman-McPherson Suture Tying Forcep**  
 Angled, With Tying Platform, 7.5 mm  
 Overall Length 10 cm (4")



**37-784-10 T**  
**Kelman-McPherson Suture Tying Forcep**  
 Angled, With Tying Platform, 7.5 mm Titanium  
 Overall Length 10 cm (4")



**37-790-10**  
**Kurstin Flap Stretching Forcep**  
 Disc Shaped, Serrated Jaws  
 Overall Length 10.5 cm (4")



**37-793-10**  
**Buratto LASIK Flap Forcep**  
 Curved, Disc Shaped, Serrated Jaws  
 Overall Length 10.5 cm (4")

Eye Surgery Forceps  
Augenchirurgie Pinzetten  
Ojo Pinzas Cirugia  
Pince de chirurgie oculaire  
Eye Pinze Chirurgia



**37-795-10**  
**Mendez Multipurpose LASIK Forcep**  
Angled, Spatulated Jaws & Tip  
Overall Length 10 cm (4")



**37-797-10**  
**Kraff Capsule Tag Forcep**  
Angled, 11 mm, 1.5 mm  
Overall Length 10.5 cm (4")



**37-801-10**  
**Utrata Capsulorrhexis Forcep**  
Very Delicate Triangular Grasping Tips Extremely Thin, 11 mm  
Over Length 10.5 cm (4")

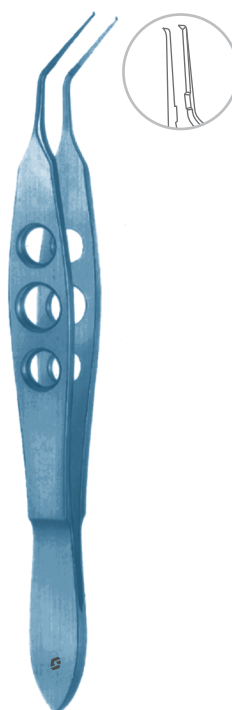

**37-801-10 T**  
**Utrata Capsulorrhexis Forcep**  
Very Delicate Triangular Grasping Tips Extremely Thin, 11 mm, Titanium  
Overall Length 10.5 cm (4")



TITANIUM



Eye Surgery Forceps  
Augenchirurgie Pinzetten  
Ojo Pinzas Cirugía  
Pince de chirurgie oculaire  
Eye Pinze Chirurgia



**37-803-10**  
**Jaffe Capsulorrhexis Forcep**  
Very Delicate Round Grasping Tip  
Extremely Thin, 11 mm  
Overall Length 10.5 cm (4")



**37-805-10**  
**O'Gawa-Utrata Capsulorrhexis Forcep**  
Very Delicate, Round Grasping Tips  
Extremely Thin  
Overall Length 11.5 cm (4 1/2")



**37-807-11**  
**Inamura Capsulorrhexis Forcep**  
Delicate Tapered 12 mm Long Shanks  
Overall Length 11.5 cm (4 1/2")



**37-809-10**  
**Masket Capsulorrhexis Forcep**  
With Very Delicate Triangle Grasping Tip & Very  
Delicate Vaulted Shanks, Length 11 mm  
Overall Length 11.5 cm (4 1/2")

Eye Surgery Forceps  
 Augenchirurgie Pinzetten  
 Ojo Pinzas Cirugia  
 Pince de chirurgie oculaire  
 Eye Pinze Chirurgia



**37-810-10**  
**Jaffe Suture Tying Forcep**  
 Straight, Very Delicate  
 Smooth Jaws, 6 mm  
 Overall Length 10.5 cm (4")



**37-811-10**  
**Jaffe Suture Tying Forcep**  
 Curved, Very Delicate  
 Smooth Jaws 6 mm  
 Overall Length 10.5 cm (4")



**37-816-10**  
**Tennant Suture Tying Forcep**  
 Straight, Round Handle With  
 Guide Pin Extra Delicate  
 Smooth Jaws, 6 mm  
 Overall Length 10.5 cm (4")



**37-816-10 T**  
**Tennant Suture Tying Forcep**  
 Straight, Round Handle With  
 Guide Pin Extra Delicate Smooth  
 Jaws, 6 mm  
 Overall Length 10.5 cm (4")



Eye Surgery Forceps  
 Augenchirurgie Pinzetten  
 Ojo Pinzas Cirugía  
 Pince de chirurgie oculaire  
 Eye Pinze Chirurgia



**37-817-10**  
**Tennant Suture Tying Forcep**  
 Curved, Round Handle With Guide Pin  
 Extra Delicate Smooth Jaws, 6 mm  
 Overall Length 10.5 cm (4")

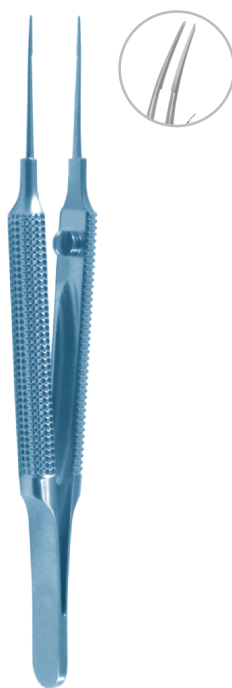

**37-817-10 T**  
**Tennant Suture Tying Forcep**  
 Curved, Round Handle With Guide Pin  
 Extra Delicate Smooth Jaws, 6 mm  
 Titanium  
 Overall Length 10.5 cm (4")



**37-820-10**  
**Harms Suture Tying Forcep**  
 Straight  
 Overall Length 10.5 cm (4")



**37-821-10**  
**Harms Suture Tying Forcep**  
 Curved  
 Overall Length 10.5 cm (4")

Eye Surgery Forceps  
Augenchirurgie Pinzetten  
Ojo Pinzas Cirugia  
Pince de chirurgie oculaire  
Eye Pinze Chirurgia



**37-824-10**  
**Helveston Suture Tying Forcep**  
Straight  
Overall Length 10.5 cm (4")



**37-825-10**  
**Fine Suture Tying Forcep**  
Curved  
Overall Length 10.5 cm (4")

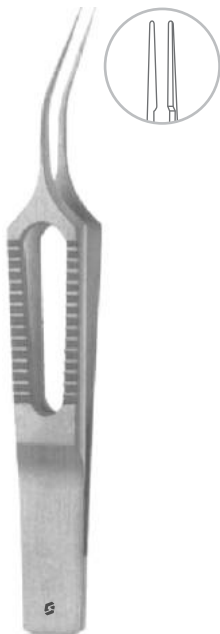

**37-827-08**  
**Gerl Suture Tying Forcep**  
Smooth Jaws, Curved Shanks, 6 mm  
Overall Length 8.5 cm (3 1/4")



**37-827-08 T**  
**Gerl Suture Tying Forcep**  
Smooth Jaws, Curved Shanks, 6 mm  
Titanium  
Overall Length 8.5 cm (3 1/4")





Eye Surgery Forceps  
Augenchirurgie Pinzetten  
Ojo Pinzas Cirugía  
Pince de chirurgie oculaire  
Eye Pinze Chirurgia



**37-830-10**  
**Gradle Cilia Forcep**  
Smooth Jaws  
Overall Length 10 cm (4")



**Bonaccolto Conjunctival Forcep**  
Overall Length 10 cm (4")

**37-834-12**  
Longitudinal Serrated Jaws  
With Cross Serrated Tips, 1.2 mm

**37-834-17**  
Longitudinal Serrated Jaws  
With Cross Serrated Tips, 1.7 mm



**37-836-10**  
**Lister Conjunctival Forcep**  
1 x 2 Teeth  
Overall Length 10 cm (4")

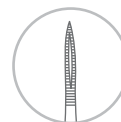

**37-838-10**  
**Moorfield Conjunctival Forcep**  
Overall Length 10 cm (4")

Eye Surgery Forceps  
 Augen Chirurgie Pinzetten  
 Ojo Pinzas Cirugia  
 Pince de chirurgie oculaire  
 Eye Pinze Chirurgia

 1:2

**Nugent Utility Forcep**  
 Overall Length 10 cm (4")

**37-840-10**  
 Smooth Jaws

**37-842-10**  
 Serrated Jaws

**37-844-11**  
**Lister Utility Forcep**  
 Serrated Jaws  
 1 x 2 Teeth  
 Overall Length 11 cm (4 1/4")

**37-847-08**  
**Scleral Plug Removing Forcep**  
 Overall Length 8.5 cm - (3 1/2")

**37-846-10**  
**Gold Punctal Plug Forcep**  
 With Longitudinal Groove  
 Pointed Tip  
 Overall Length 11 cm (4 1/4")

Eye Surgery Forceps  
Augenchirurgie Pinzetten  
Ojo Pinzas Cirugía  
Pince de chirurgie oculaire  
Eye Pinze Chirurgia



**37-848-11**  
**Osher Iris Forcep**  
Very Fine Textured Jaws  
Overall Length 11 cm (4 1/4")



**37-850-11**  
**Foreign Body Forcep**  
Straight  
Overall Length 8.5 cm (3 1/4")



**37-855-11**  
**Jaffe Utility Forcep**  
Curved, Very Delicate  
Smooth Jaws  
Overall Length 11 cm (4 1/4")



**37-857-11**  
**Castroviejo Capsule Forcep**  
Overall Length 11 cm (4 1/4")



**37-859-11**  
**Arruga Capsule Forcep**  
Curved, Very Delicate  
Overall Length 11 cm (4 1/4")

Eye Surgery Forceps  
 Augenchirurgie Pinzetten  
 Ojo Pinzas Cirugia  
 Pince de chirurgie oculaire  
 Eye Pinze Chirurgia



**37-861-11**  
**Akahoshi Phaco PreChopper**  
 Delicate Jaws With Sharp Tip  
 4.5 mm  
 Overall Length 11 cm (4 1/4")



**37-863-11**  
**Ernest Nucleus Cracker**  
 Extra Delicate Cross Action  
 Serrated Paddle Tip  
 Overall Length 11 cm (4 1/4")



**37-867-11**  
**Dodick Nucleus Cracker**  
 Cross Action, Longitudinally  
 Serrated Paddle Shaped Jaws  
 Overall Length 11 cm (4 1/4")



**37-869-10**  
**Alfonso Nucleus Grasping Forcep**  
 With Two Short Rows of Delicate  
 Interlocking Teeth  
 Overall Length 10.5 cm (4")



Eye Surgery Forceps  
 Augen Chirurgie Pinzetten  
 Ojo Pinzas Cirugía  
 Pince de chirurgie oculaire  
 Eye Pinze Chirurgia



**37-871-11**  
**Rosenwasser Donor Lamella Inserting Forcep**  
 With Vaulted Shanks  
 Overall Length 11 cm (4 1/4")



**37-875-11**  
**Dodick IOL Folding Forcep**  
 For Short IOLs  
 Overall Length 11 cm (4 1/4")



**37-877-10**  
**Livernois IOL Folding Forcep**  
 Concave Jaw Surfaces, For Soft IOLs  
 Overall Length 11 cm (4 1/4")

Eye Surgery Forceps  
Augenchirurgie Pinzetten  
Ojo Pinzas Cirugia  
Pince de chirurgie oculaire  
Eye Pinze Chirurgia



**37-879-10**  
**Steinert IOL Inserting Forcep**  
Conically Shaped Jaws  
Overall Length 10 cm (4")



**37-882-10**  
**Livernois IOL Holding Forcep**  
Straight, Highly Polished Round  
Jaws For Holding Soft IOLs  
Overall Length 10.5 cm (4")



**37-883-10**  
**Livernois IOL Holding Forcep**  
Angled, Highly Polished Round  
Jaws For Holding Soft IOLs  
Overall Length 10.5 cm (4")

Eye Surgery Forceps  
Augenchirurgie Pinzetten  
Ojo Pinzas Cirugía  
Pince de chirurgie oculaire  
Eye Pinze Chirurgia



**37-885-10**  
**Livernois-McDonald IOL Inserting Forcep**  
Concave Jaws, 5.0 mm  
Overall Length 10.5 cm (4")



**37-887-10**  
**Faulkner Lens Holding Forcep**  
Round, Smooth Jaws  
Overall Length 10 cm (4")



**37-889-10**  
**Buratto IOL Inserting Forcep**  
Extra Delicate Highly Polished Convex Jaws  
For Soft IOLs  
Overall Length 10 cm (4")

Eye Surgery Forceps  
Augenchirurgie Pinzetten  
Ojo Pinzas Cirugia  
Pince de chirurgie oculaire  
Eye Pinze Chirurgia



**37-891-12**  
**Bechert Lens Holding Forcep**  
Very Delicate Flat Jaws  
Overall Length 12.5 cm (5")



**37-893-12**  
**Kratz Lens Holding Forcep**  
Very Delicate Narrow Jaws  
Overall Length 12.5 cm (5")



**37-895-11**  
**Blaydes Lens Holding Forcep**  
Very Delicate Narrow Jaws  
Angled 45°  
Overall Length 11.5 cm (4 ½")



**37-897-12**  
**Shepard Lens Holding Forcep**  
Gently Curved, Duckbill Shaped Jaws  
Overall Length 12.5 cm (5")



Eye Surgery Forceps  
Augenchirurgie Pinzetten  
Ojo Pinzas Cirugía  
Pince de chirurgie oculaire  
Eye Pinze Chirurgia



**37-899-12**  
**Clayman Lens Holding Forcep**  
Gently Curved, Blades With  
Delicately Angled Jaws  
Overall Length 12.5 cm (5")

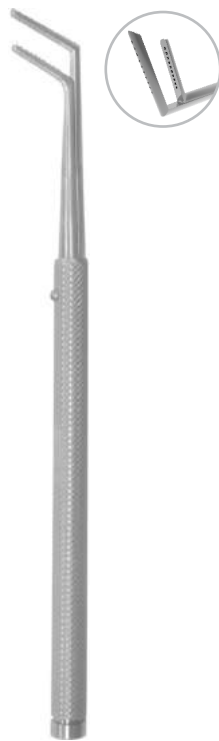

**37-900-10**  
**Bangerter Muscle Clamp**  
With 10 Delicate Teeth  
and Push Button  
Overall Length 10 cm (4")



**37-901-01**  
**Jameson Muscle Forcep**  
Right, With Slide Lock,  
4 Teeth, Child Size  
Overall Length 9.5 cm (3 ¾")



**37-901-02**  
**Jameson Muscle Forcep**  
Left, With Slide Lock,  
4 Teeth, Child Size  
Overall Length 9.5 cm (3 ¾")

Eye Surgery Forceps  
Augenchirurgie Pinzetten  
Ojo Pinzas Cirugia  
Pince de chirurgie oculaire  
Eye Pinze Chirurgia



**37-903-01**  
**Jameson Muscle Forcep**  
Right, With Slide Lock,  
6 Teeth, Adult Size  
Overall Length 10 cm (4")



**37-903-02**  
**Jameson Muscle Forcep**  
Left, With Slide Lock,  
6 Teeth, Adult Size  
Overall Length 10 cm (4")



**37-905-20**  
**Berke Ptosis Forcep**  
Longitudinally Grooved  
Jaws, With Side Lock, 20 mm  
Overall Length 11 cm (4 1/4")



**37-905-27**  
**Berke Ptosis Forcep**  
Longitudinally Grooved  
Jaws, With Side Lock, 27 mm  
Overall Length 11 cm (4 1/4")

Eye Surgery Forceps  
Augenchirurgie Pinzetten  
Ojo Pinzas Cirugía  
Pince de chirurgie oculaire  
Eye Pinze Chirurgia



**37-906-10**  
**Putterman-Muellers Muscle Conjunctival Resection Ptosis Clamp**  
With Slide Lock,  
Overall Length 10 cm (4")



**37-907-11**  
**Watzke Sleeve Spreading Forcep**  
Jaw Length 10 mm  
Overall Length 11.5 cm (4 1/2")



**37-908-10**  
**Erhardt Lid Forcep**  
Overall Length 10.5 cm (4")

Eye Surgery Forceps  
Augenchirurgie Pinzetten  
Ojo Pinzas Cirugia  
Pince de chirurgie oculaire  
Eye Pinze Chirurgia

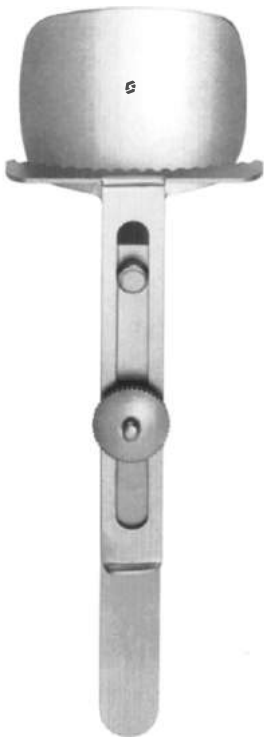

**37-910-09**  
**Downes Lid Clamp**  
Overall Length 9.5 cm (3 3/4")



**37-912-08**  
**Lambert Chalazion Forcep**  
Round Jaws, Ø 8.0 mm  
Overall Length 9 cm (3 1/2")



**37-912-12**  
**Hunt Chalazion Forcep**  
Round Jaws, Ø 12.0 mm  
Overall Length 9.5 cm (3 3/4")



**37-914-09**  
**Baird Chalazion Forcep**  
Small, Oval Jaws, 11 x 8 mm  
Overall Length 9.5 cm (3 3/4")

Eye Surgery Forceps  
 Augenchirurgie Pinzetten  
 Ojo Pinzas Cirugía  
 Pince de chirurgie oculaire  
 Eye Pinze Chirurgia



**37-916-09**  
**Francis Chalazion Forcep**  
 Medium, Oval Jaws, 14 x 11 mm  
 Overall Length 9.5 cm (3 3/4")



**37-918-09**  
**Desmarres Chalazion Forcep**  
 Large, Oval Jaws, 20 x 13 mm  
 Overall Length 9.5 cm (3 3/4")



**37-920-09**  
**Wies Chalazion Forcep**  
 Grooved Upper Jaws  
 Overall Length 9.5 cm (3 3/4")



**37-921-09**  
**Lordan Chalazion Forcep**  
 Triangular Jaws  
 Overall Length 9.5 cm (3 3/4")

Eye Surgery Forceps  
Augenchirurgie Pinzetten  
Ojo Pinzas Cirugia  
Pince de chirurgie oculaire  
Eye Pinze Chirurgia

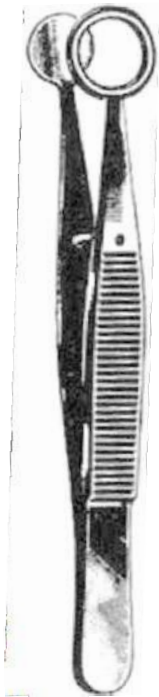

**37-922-01**  
**Ayer Chalazion Forcep**  
Round Jaws, Ø 12.0 mm  
Overall Length 9.5 cm (3 ¾")



**37-923-01**  
**Desmarres Entropian Forcep**  
Right  
Overall Length 10 cm (4")



**37-923-02**  
**Desmarres Entropian Forcep**  
Left  
Overall Length 10 cm (4")

Bulldog Clamps, Haemostatic Forceps  
 Bulldogklemmen, Arterienklemmen  
 Clamps Bulldog, Pinzas hemostáticas  
 Clamps Bulldog, Pincas hémostatiques  
 Pinze Bulldog, Pinze emostatische



**Dieffenbach Bulldog Clamp**  
 3.5 cm (1 1/2")

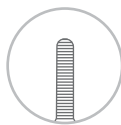

**23-062-03**  
 Straight



**23-063-03**  
 Curved



**Hartmann Haemostatic Forcep**

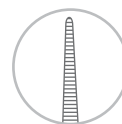

**23-140-10**  
 Straight  
 10 cm (4")



**23-141-10**  
 Curved  
 9.5 cm (3 3/4")



**Halsted-Mosquito Haemostatic Forcep**



**23-160-12**  
 Straight  
 12.5 cm (4 3/4")



**23-161-12**  
 Curved  
 12 cm (4 3/4")



**Micro-Mosquito Haemostatic Forcep**



**23-170-10**  
 Straight  
 10 cm (4")



**23-171-10**  
 Curved  
 9.5 cm (3 3/4")



**23-172-10**  
 Straight  
 1 x 2 Teeth  
 10 cm (4")

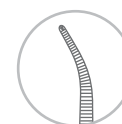

**23-173-10**  
 Curved  
 1 x 2 Teeth  
 10 cm (4")

Towel Clamps  
Tuchklemmen  
Pinzas de campo  
Pinces à champs  
Pinze fissatele



**23-761-05**  
**Jones Towel Clamp**  
Sharp  
Overall Length 5.5 cm (2 1/2")

**23-761-09**  
Sharp  
Overall Length 8.5 cm (3 1/4")



**23-773-08**  
**Backhaus Towel Clamp**  
Overall Length 9 cm (3 1/2")



Sphenoid Bone Punches  
Keilbeinstanzen  
Pinzas sacabocadas para esfenoides  
Pinces emporte-pièces pour sinus sphénoïdal  
Pinze taglienti per seno sfenoidale



**Citelli Mastoid Rongeur**  
Shaft Length 17 cm (6 3/4")

  
**67-751-02**  
Bite Size 2.0 mm

  
**67-751-03**  
Bite Size 3.0 mm



**Kerrison Sphenoid Punch**

  
**74-305-03**  
Up Cutting  
Bite Size Ø 3.0 mm x 3.0 mm  
Shaft Length 14 cm (5 1/2")

  
**74-305-04**  
Up Cutting  
Bite Size Ø 4.0 mm x 4.0 mm  
Shaft Length 9 cm (3 1/2")

  
**74-305-05**  
Up Cutting  
Bite Size Ø 5.0 mm x 5.0 mm  
Shaft Length 9 cm (3 1/2")

  
**74-305-06**  
Up Cutting  
Bite Size Ø 6.0 mm x 6.0 mm  
Shaft Length 9 cm (3 1/2")

Septum Chisels, Septum Gouges, Nasal Specula  
 Septummeißel, Septum-Hohlmeißel, Nasenspekula  
 Cinceles para tabique nasal, Gubias para tabique nasal, Espéculos nasales  
 Élévateurs pour le périoste, Gouges pour la cloison nasale, Spécuments nasaux  
 Elevatori per il periosto, Sgorbie per il setto nasale, Specoli nasali



**74-033-01**

27 mm, Fig. 1



**74-033-02**

31 mm, Fig. 2

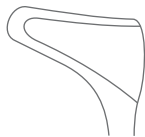

**74-033-03**

35 mm, Fig. 3

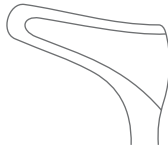

**Hartmann-Halle Nasal Speculum**

Overall Length 15.5 cm (6")



**74-475-18**

**Freer Septum Elevator**

Double Ended, Sharp/Blunt, Blades Size 5.0 mm, 5.0 mm  
 Overall Length 18.5 cm (7 1/4")



**74-600-16**

**Freer Septum Chisel**

Straight, 4.0 mm  
 Overall Length 16.5 cm (6 1/2")

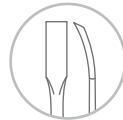

**74-601-16**

**Freer Septum Chisel**

Curved, 4.0 mm  
 Overall Length 16.5 cm (6 1/2")



**74-604-16**

**West Septum Chisel**

Overall Length 16 cm (6 1/4")



**74-605-16**

**West Septum Gouge**

Overall Length 16 cm (6 1/4")

Micro Needle Holders  
Mikro-Nadelhalter  
Micro Porta-agujas  
Micro Porte-aiguilles  
Micro Portaghi



Heavy Pattern

**78-040-13**  
**Brown Needle Holder**  
Overall Length 13 cm (5")

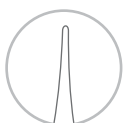

**78-200-10**  
Straight



**78-201-10**  
Curved



**78-202-10**  
Straight



**78-203-10**  
Curved

**McPherson Micro Needle Holder**  
Very Delicate Tips, Without Lock  
Overall Length 10 cm (4")

**McPherson Micro Needle Holder**  
Very Delicate Tips, With Lock  
Overall Length 10 cm (4")

Micro Needle Holders  
Mikro-Nadelhalter  
Micro Porta-agujas  
Micro Porte-aiguilles  
Micro Portaghi

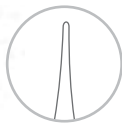

**78-210-14**  
Straight



**78-211-14**  
Curved

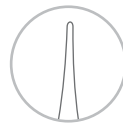

**78-212-14**  
Straight



**78-213-14**  
Curved

**Castroviejo Micro Needle Holder**

Delicate Tips, Without Lock  
Overall Length 14 cm (5 1/2")

**Castroviejo Micro Needle Holder**

Delicate Tips, With Lock  
Overall Length 14 cm (5 1/2")

Micro Needle Holders  
Mikro-Nadelhalter  
Micro Porta-agujas  
Micro Porte-aiguilles  
Micro Portaghi

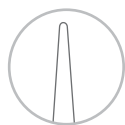

**78-220-14**  
Straight



**78-221-14**  
Curved



**78-222-14**  
Straight



**78-223-14**  
Curved

**Castroviejo Micro Needle Holder**  
Standard Tips, Without Lock  
Overall Length 14 cm (5 1/2")

**Castroviejo Micro Needle Holder**  
Standard Tips, With Lock  
Overall Length 14 cm (5 1/2")

Micro Needle Holders  
Mikro-Nadelhalter  
Micro Porta-agujas  
Micro Porte-aiguilles  
Micro Portaghi

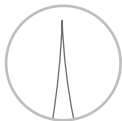

**78-300-10**  
Straight



**78-301-10**  
Curved

**Barraquer-Troutman Micro Needle Holder**  
Round Handle, Extra Delicate Tips, Without Lock  
Overall Length 10 cm (4")

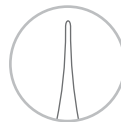

**78-310-10**  
Straight  
With Lock  
10.5 cm (4")

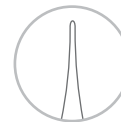

**78-310-11**  
Straight  
With Lock  
11.5 cm (4 ½")



**78-311-10**  
Curved  
With Lock  
10.5 cm (4")



**78-311-11**  
Curved  
With Lock  
11.5 cm (4 ½")

**Barraquer-Troutman Micro Needle Holder**  
Round Handle, Very Delicate Tips



Micro Needle Holders  
Mikro-Nadelhalter  
Micro Porta-agujas  
Micro Porte-aiguilles  
Micro Portaghi



**78-313-11**  
Curved, Delicate  
Round Handle

**Barraquer Micro Needle Holder**  
Overall Length 11.5 cm (4 1/2")



**78-315-11**  
Curved, Delicate  
Round Handle  
With Lock

**Barraquer Micro Needle Holder**  
Overall Length 11.5 cm (4 1/2")



**78-315-11 T**  
Curved, Delicate  
Round Handle  
With Lock, Titanium

**Barraquer Micro Needle Holder**  
Overall Length 11.5 cm (4 1/2")



Micro Needle Holders  
Mikro-Nadelhalter  
Micro Porta-agujas  
Micro Porte-aiguilles  
Micro Portaghi

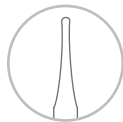

**78-320-13**  
Straight



**78-321-13**  
Curved

**Barraquer Micro Needle Holder**  
Round Handle, Very Delicate Tips, Without Lock  
Overall Length 13 cm (5")

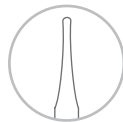

**78-322-13**  
Straight



**78-323-13**  
Curved

**Barraquer Micro Needle Holder**  
Round Handle, Very Delicate Tips, With Lock  
Overall Length 13 cm (5")





Micro Needle Holders  
Mikro-Nadelhalter  
Micro Porta-agujas  
Micro Porte-aiguilles  
Micro Portaghi

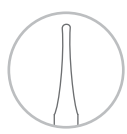

**78-331-14**  
Straight  
Very Delicate  
Round Handle

**Barraquer Micro Needle Holder**  
Overall Length 14 cm (5 1/2")

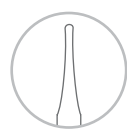

**78-331-14 T**  
Straight  
Very Delicate  
Round Handle, Titanium

**Barraquer Micro Needle Holder**  
Overall Length 14 cm (5 1/2")

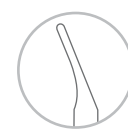

**78-333-14**  
Curved  
Very Delicate  
Round Handle  
With Lock

**Barraquer Micro Needle Holder**  
Overall Length 14 cm (5 1/2")



Micro Needle Holders  
 Mikro-Nadelhalter  
 Micro Porta-agujas  
 Micro Porte-aiguilles  
 Micro Portaghi



**78-333-14 T**  
 Curved  
 Very Delicate  
 Round Handle  
 With Lock, Titanium

**Barraquer Micro Needle Holder**  
 Overall Length 14 cm (5 1/2")



**78-341-12**  
 Without Lock



**78-343-12**  
 With Lock

**Troutman Micro Needle Holder**  
 Round Handle, Strongly Curved Delicate Tips  
 Overall Length 12 cm (4 3/4")



Micro Needle Holders  
Mikro-Nadelhalter  
Micro Porta-agujas  
Micro Porte-aiguilles  
Micro Portaghi



**78-500-13**

Curved  
Smooth Jaws  
Round Handle  
Without Lock

**UltraGrip™ TC Barraquer Micro Needle Holder**  
Overall Length 13 cm (5")

**ULTRA GRIP<sup>™</sup>X**



**78-502-13**

Curved  
Smooth Jaws  
Round Handle  
With Lock

**UltraGrip™ TC Barraquer Micro Needle Holder**  
Overall Length 13 cm (5")

**ULTRA GRIP<sup>™</sup>X**



Micro Needle Holders  
Mikro-Nadelhalter  
Micro Porta-agujas  
Micro Porte-aiguilles  
Micro Portaghi



**78-510-14**  
Straight  
With Lock

**UltraGrip™ TC Castroviejo Micro Needle Holder**  
Overall Length 14.5 cm (5 ¾")

**ULTRA GRIP<sup>™</sup>**



**78-511-14**  
Curved  
With Lock

**UltraGrip™ TC Castroviejo Micro Needle Holder**  
Overall Length 14.5 cm (5 ¾")

**ULTRA GRIP<sup>™</sup>**



Micro Needle Holders  
Mikro-Nadelhalter  
Micro Porta-agujas  
Micro Porte-aiguilles  
Micro Portaghi

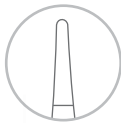

**78-512-14**  
Straight, Smooth Jaws  
With Lock

**UltraGrip™ TC Castroviejo Micro Needle Holder**  
Overall Length 14.5 cm (5 3/4")

**ULTRA GRIP** X



**78-513-14**  
Curved, Smooth Jaws  
With Lock

**UltraGrip™ TC Castroviejo Micro Needle Holder**  
Overall Length 14.5 cm (5 3/4")

**ULTRA GRIP** X



Calipers  
Schieblehren  
Calibres  
Pieds à coulisse  
Calibro



**34-850-20**  
**Castroviejo Caliper**  
Straight  
Measuring Range 20 mm  
Overall Length 14.5 cm (5 3/4")



**34-880-15**  
**Ruler**  
Graduated in mm & inches  
Measuring Range 150 mm  
Overall Length 10 cm (4")



**78-048-01**  
Fig. 1



**78-048-02**  
Fig. 2



**78-048-03**  
Fig. 3

**Graefe Nerve Hook**  
Blunt  
Overall Length 14 cm (5 1/2")



**78-066-13**  
4 Sharp Prongs



**78-068-13**  
4 Blunt Prongs

**Knapp Fine Wound Retractor**  
Overall Length 13.5 cm (5 1/4")



**78-074-02**  
2.0 mm



**78-074-05**  
5.0 mm



**78-074-07**  
7.0 mm



**78-074-10**  
10.0 mm

**Joseph Mucus Hook**  
Overall Length 16.5 cm (6 1/2")



**78-120-08**  
8.0 mm



**78-120-10**  
10.0 mm

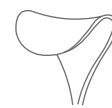

**78-120-12**  
12.0 mm

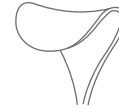

**78-120-14**  
14.0 mm

**Desmarres Lid Retractor**  
Overall Length 16 cm (6 1/4")



Bone Rongeurs  
Hohlmeißelzangen  
Pinzas gubias  
Pinces-gouges  
Pinze-sgorbie



**67-470-19**  
**Cottle Bone Mallet**  
Plain, Convex, Ø 30.0 mm,  
300 Grams  
Overall Length 19 cm (7 1/2")



**Friedman Bone Rongeur**  
Overall Length 13.5 cm (5 1/4")



**67-933-01**



**67-934-02**



**67-937-16**  
**Mead Bone Rongeur**  
Overall Length 16.5 cm (6 1/2")

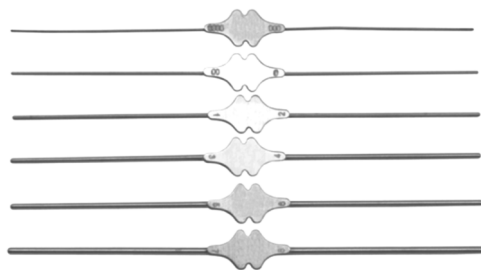

**77-200-00**  
**Bowman Lacrimal Probes Complete**  
Set of 6 Probes

Sterilizing Cases  
Sterilisierbehälter Koffer  
Los casos de esterilización  
Stérilisation cas  
Sterilizzazione Custodie i

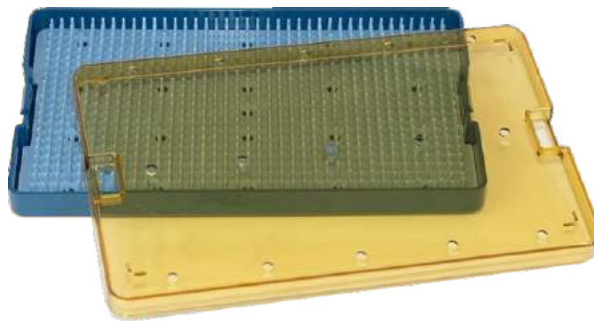

**78-110-01**  
**Storing Case Plastic**  
Single Level With Perforated  
Silicone Mat Size 160 x 70 x 25

**78-110-02**  
**Storing Case Plastic**  
Single Level With Perforated  
Silicone Mat Size 200 x 110 x 25

**78-110-03**  
**Storing Case Plastic**  
Single Level With Perforated  
Silicone Mat Size 265 x 160 x 25

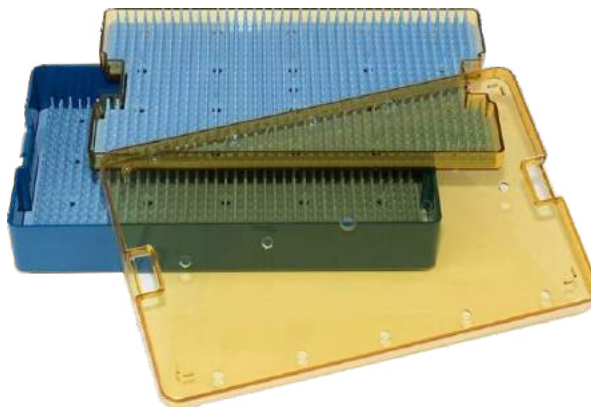

**78-112-26**  
**Storing Case Plastic**  
Double Level With Perforated  
Silicone Mat Size 265 x 160 x 50



## Basic Eye Surgery Set

Codes	Description	Quantity
75-010-03	Bard-Parker Scalpel Handle No. 3 Solid 12 cm - 4 3/4"	1
75-030-07	Scalpel Handle No. 7 Solid 16 cm - 6 1/4"	1
75-206-13	Scalpel Handle For Micro Scalpel Blades 13 cm - 5"	1
77-430-10	Iris Scissor Straight 10 cm - 4"	1
77-431-10	Iris Scissor Curved 10 cm - 4"	1
23-170-12	Micro-Mosquito Haemostatic Forcep Straight 12 cm - 4 3/4"	4
23-171-12	Micro-Mosquito Haemostatic Forcep Curved 11.5 cm - 4 1/2"	6
23-773-08	Backhaus Towel Clamp 9 cm - 3 1/2"	4
77-423-09	Very Delicate Operating Scissor Curved 9 cm - 3 1/2"	1
75-010-15	Barraquer Wire Speculum Standard Wire Blade Size 15 mm	1
75-083-15	Lieberman Eye Speculum Adjustable Blade Size 15 mm	1
75-091-14	Castroviejo Eye Speculum Adjustable Mechanism Blade Size 14 mm	1
75-175-15	Desmarres Lid Retractor Thin Solid Blades - Size 2 13 cm - 5" Blade Width 15 mm	1
78-048-02	Graefe Nerve Hook Fig. 2 14 cm - 5 1/2"	1
75-745-50	Castroviejo Cyclodialysis Spatula 13 cm - 5" Width 0.5 mm	1
34-850-20	Castroviejo Caliper Straight 8 cm - 3" Measuring Range 20 mm	1
37-700-01	Graefe Eye Dressing Forcep 10 cm - 4"	1
37-700-02	Graefe Eye Dressing Forcep 10 cm - 4"	1
37-702-01	Graefe Dissecting Forcep 1 x 2 Teeth 10 cm - 4"	1
37-702-02	Graefe Dissecting Forcep 1 x 2 Teeth 10 cm - 4"	1
37-772-01	Graefe Fixation Forcep 11 cm - 4 1/4"	1
37-750-03	Castroviejo Suture Tying Forcep 1 x 2 Teeth with Tying Platform 11 cm - 4 1/4" Tip Size 0.3 mm	1
37-859-11	Arruga Capsule Forcep 11 cm - 4 1/4"	1
37-918-09	Desmarres Chalazion Forcep Large - Oval Jaws 9 cm - 3 1/2" Jaw Size 20 x 13 mm	1
77-453-11	Stevens Tenotomy Scissor Curved - Blunt/Blunt 11 cm - 4 1/2"	1
77-653-01	Castroviejo Corneoscleral Scissor Right - Medium Blades 11 cm - 4 1/2"	1
77-653-02	Castroviejo Corneoscleral Scissor Left - Medium Blades 11 cm - 4 1/2"	1
77-630-12	Noyes Iris Scissor Straight - Sharp/Sharp 12.5 cm - 5"	1
77-631-12	Noyes Iris Scissor Curved - Sharp/Sharp 12.5 cm - 5"	1
77-683-11	Westcott Stitch Scissor Curved - Very Sharp Pointed Tips - Standard Blades 11.5 cm - 4 1/2"	1
78-222-14	Castroviejo Micro Needle Holder Straight - Standard - With Lock 14 cm - 5 1/2"	1
75-180-02	Scleral Shield Large (Pair) Blade Width 22 x 30 mm	2
78-112-26	Storing Case Double Level 265 x 160 x 50 mm Plastic	1

## Planned Extra-Capsular Cataract Extraction

Codes	Description	Quantity
75-471-19	Bishop-Harmon Anterior Chamber Irrigator Gauge 19	1
23-761-05	Jones Towel Clamp Sharp 5.5 cm - 2 1/4"	2
23-140-10	Hartmann Haemostatic Forcep Straight 10 cm - 4"	1
23-062-03	Dieffenbach Bulldog Clamp Straight 3.5 cm - 1 1/2"	1
75-083-15	Lieberman Eye Speculum Adjustable Blade Size 15 mm	1
75-010-15	Barraquer Wire Speculum Standard Wire Blade Size 15 mm	1
75-206-13	Scalpel Handle For Micro Scalpel Blades 13 cm - 5"	2
75-210-69 A	Micro Scalpel Blade No. 69A Pack of 25	1
75-232-15	Disposable Stab Knife Straight 15 Degree Cutting Edge Box of 6	1
75-320-01	Diamond Step Knife With Adjustable Cutting Depth of 0/0.3/0.4/0.5/0.6/0.8/1.0/2.5 mm Single 45° Cutting Edge 12 cm - 4 3/4" Width 1.0 mm Titanium Handle	1
75-865-13	Fine-Thronton Swivel Fixation Ring With Swivel Handle 12 cm - 4 3/4" Tip Ø 13 mm	1
77-651-01	Castroviejo Corneoscleral Scissor Right - Small Blades 10.5 cm - 4"	1
77-651-02	Castroviejo Corneoscleral Scissor Left - Small Blades 10.5 cm - 4"	1
77-675-11	Westcott Tenotomy Scissor Curved - Blunt Tips - Medium Blades 11 cm - 4 1/2"	1
77-683-11	Westcott Stitch Scissor Curved - Very Sharp Pointed Tips - Standard Blades 11.5 cm - 4 1/2"	1
77-695-08	Vannas Capsulotomy Scissor Curved - Sharp Tips 8 cm - 3 1/4" Blade Size 5 mm	1
77-713-11	Stern-Gills Micro Scissor Angled Forward - Sharp Tips - Extra Thin 11 cm - 4 1/2" Blade Size 10 mm	1
34-850-20	Castroviejo Caliper Straight 8 cm - 3" Measuring Range 20 mm	1
37-834-12	Bonaccolto Conjunctival Forcep Longitudinal Serrated Jaws with Cross Serrations at Tips 10.5 cm - 4" Tip Width 1.2 mm Stainless Steel	1
37-718-07	Harms-Colibri Corneal Forcep Very Delicate 1 x 2 Teeth with Tying Platform 7.5 cm - 3 1/4" Tip Size 0.12 mm	1
37-732-10	Bonn Corneal Forcep Very Delicate 1 x 2 Teeth with Tying Platform 10 cm - 4" Tip Size 0.12 mm	1
37-760-08	Bishop-Harmon Iris Forcep Standard 1 x 2 Teeth 8.5 cm - 3 1/4"	1
37-780-10	McPherson Suture Tying Forcep Straight - With Tying Platform 10 cm - 4" Jaws Length 5 mm	1
37-781-10	McPherson Suture Tying Forcep Angled - With Tying Platform 10 cm - 4" Jaws Length 5 mm	1
37-784-10	Kelman-McPherson Suture Tying Forcep Angled - With Tying Platform 10 cm - 4" Jaws Length 7.5 mm	1
37-801-10	Utrata Capsulorrhesis Forcep Very Delicate Triangular Grasping Tips - Extremely Thin 10.5 cm - 4" Shanks Length 11 mm	1
75-677-11	Nagahara Nucleus Chopper And Spatula 11 cm - 4 1/4"	1
75-826-04	Sinsky II Lens Manipulating Hook Angled 11.5 cm - 4 1/2" Tip Diameter 0.2 mm	1
75-827-02	Kuglen Iris Hook and Lens Manipulator Push Pull Modle - Angled 11.5 cm - 4 1/2"	1
75-635-02	Barraquer Iris Spatula Round - Smooth 12 cm - 4 3/4" Width 0.5 mm	2
78-313-11	Barraquer Micro Needle Holder Curved - Delicate - Round Handle 11.5 cm - 4 1/2"	1
78-213-14	Castroviejo Micro Needle Holder Curved - Delicate - With Lock 14 cm - 5 1/2"	1
75-750-02	Lewis Lens Loop Large 14 cm - 5 1/2"	1
75-765-10	Alfonso Nucleus Trisector For Use With Ref:- 75-775-02 10.5 cm - 4 1/4" Width 1.5 mm	1
75-775-02	Alfonso Cutting Platform 12.5 cm - 5" Width 2 mm Stainless Steel	1
37-869-10	Alfonso Nucleas Grasping Forcep With Two Short Rows of Delicate Interlocking Teeth 10.5 cm - 4"	1
75-542-25	Alfonso Nucleus Irrigating Spoon 2.5 mm Wide	1
75-542-40	Alfonso Nucleus Irrigating Spoon 4.0 mm Wide	1
75-519-30	Gimbel Cortex Aspirating Cannula End Opening Gauge 30	1
75-421-27	Air Injection Cannula Angled at 5 mm Gauge 27	1
75-517-26	McIntyre Anterior Chamber Cannula Angled Gauge 26	1
75-467-23	Jansen Capsul Polisher Cannula 23 Gauge	1
75-451-23	Simcoe Irrigation Aspirating Cannula Original Modle Gauge 23	1
78-112-26	Storing Case Double Level 265 x 160 x 50 mm Plastic	1

**Corneal Graft Surgery Set**

<b>Codes</b>	<b>Description</b>	<b>Quantity</b>
75-471-19	Bishop-Harmon Anterior Chamber Irrigator Gauge 19	1
23-761-05	Jones Towel Clamp Sharp 5.5 cm - 2 1/4"	1
75-100-00	Flieringa Scleral Fixation Ring Set of 9 Ref:- 75-100-14 to 75-100-22	1
75-111-16	McNeill-Goldman Scleral Fixation Ring & Blepharostat Medium, I.D Blade Size 16 mm	1
75-010-15	Barraquer Wire Speculum Standard Wire Blade Size 15 mm	1
75-087-15	Lieberman Eye Speculum Adjustable Blade Size 15 mm	1
23-140-10	Hartmann Haemostatic Forcep Straight 10 cm - 4"	2
23-062-03	Dieffenbach Bulldog Clamp Straight 3.5 cm - 1 1/2"	2
77-659-01	Troutman-Katzin Corneal Transplant Scissor Right - Strongly Curved - Small Blades - With Lock 10.5 cm - 4"	1
77-659-02	Troutman-Katzin Corneal Transplant Scissor Left - Strongly Curved - Small Blades - With Lock 10.5 cm - 4"	1
77-675-11	Westcott Tenotomy Scissor Curved - Blunt Tips - Medium Blades 11 cm - 4 1/2"	1
77-685-11	Jaffe Stitch Scissor Curved - Very Sharp Pointed Tips - Medium Blades 11 cm - 4 1/2"	1
75-685-11	Rosen Phaco Splitter Angled 60° - Wedge Shaped 11.5 cm - 4 1/2"	1
75-400-06	Corneal Trephine Blade Diameter 7.5 mm	1
75-400-08	Corneal Trephine Blade Diameter 8.0 mm	1
75-401-06	Corneal Trephine Handle Diameter 7.5 mm	1
75-401-08	Corneal Trephine Handle Diameter 8.0 mm	1
37-720-07	Colibri Corneal Forcep Standard 1 x 2 Teeth with Tying Platform 7.5 cm - 3 1/4" Tip Size 0.4 mm	1
37-750-01	Castroviejo Suture Tying Forcep 1 x 2 Teeth with Tying Platform 11 cm - 4 1/4" Tip Size 0.12 mm	1
37-750-03	Castroviejo Suture Tying Forcep 1 x 2 Teeth with Tying Platform 11 cm - 4 1/4" Tip Size 0.3 mm	1
37-718-07	Harms-Colibri Corneal Forcep Very Delicate 1 x 2 Teeth with Tying Platform 7.5 cm - 3 1/4" Tip Size 0.12 mm	1
37-816-10	Tennant Suture Tying Forcep Straight - Round Handle with Guide Pin - Extra Delicate Smooth Jaws 10.5 cm - 4" Jaws Length 6 mm	1
37-817-10	Tennant Suture Tying Forcep Curved - Round Handle with Guide Pin - Extra Delicate Smooth Jaws 10.5 cm - 4" Jaws Length 6 mm	1
75-793-14	Paton Spatula & Spoon For Corneal Button Transfer 14 cm - 5 1/2"	1
78-323-13	Barraquer Micro Needle Holder Curved - Very Delicate - Round Handle - With Lock 13 cm - 5"	1
78-213-14	Castroviejo Micro Needle Holder Curved - Delicate - With Lock 14 cm - 5 1/2"	1
75-421-30	Air Injection Cannula Angled at 5 mm Gauge 30	1
75-517-26	McIntyre Anterior Chamber Cannula Angled Gauge 26	1
78-112-26	Storing Case Double Level 265 x 160 x 50 mm Plastic	1

**Phacoemulsification Cataract Extraction Set**

<b>Codes</b>	<b>Description</b>	<b>Quantity</b>
75-471-19	Bishop-Harmon Anterior Chamber Irrigator Gauge 19	1
75-083-15	Lieberman Eye Speculum Adjustable Blade Size 15 mm	2
75-030-15	Barraquer Wire Speculum Open Blades Blade Size 15 mm	1
75-316-03	Diamond Knife Tri-Facet Cutting Edge 12.5 cm - 5" Width 1.0 mm Titanium Handle	1
75-341-28	Diamond Phaco Knife Angled - Spear Shaped 13 cm - 5" Blade Width 2.8 mm Titanium Handle	1
75-230-02	Disposable Crescent Knife Angled Box of Six	1
75-232-15	Disposable Stab Knife Straight 15 Degree Cutting Edge Box of 6	1
75-206-13	Scalpel Handle For Micro Scalpel Blades 13 cm - 5"	1
23-140-10	Hartmann Haemostatic Forcep Straight 10 cm - 4"	2
23-761-05	Jones Towel Clamp Sharp 5.5 cm - 2 1/4"	2
75-659-02	Chang Phaco Chopper Left Hand 13 cm - 5" Tip Length 0.9 mm	1
75-532-27	Chang Hydrodissection Cannula Flat Tip With Bevelled Opening 27 Gauge	1
75-683-11	Rosen Phaco Splitter Wedge Shaped 11.5 cm - 4 1/2"	1
75-827-02	Kuglen Iris Hook and Lens Manipulator Push Pull Modle - Angled 11.5 cm - 4 1/2"	1
75-689-02	Jaffe-Bechert Nucleus Rotator Blunt Forked Tip - Angled At 9 mm 11.5 cm - 4 1/2"	1
75-729-12	Lester IOL Manipulator Angled 12 cm - 4 3/4" Tip Diameter 0.25 mm	1
77-675-11	Westcott Tenotomy Scissor Curved - Blunt Tips - Medium Blades 11 cm - 4 1/2"	1
34-850-20	Castroviejo Caliper Straight 8 cm - 3" Measuring Range 20 mm	1
77-713-11	Stern-Gills Micro Scissor Angled Forward - Sharp Tips - Extra Thin 11 cm - 4 1/2" Blade Size 10 mm	1
37-716-07	Colibri Corneal Forcep Very Delicate 1 x 2 Teeth 7.5 cm - 3 1/4" Tip Size 0.12 mm	1
37-750-01	Castroviejo Suture Tying Forcep 1 x 2 Teeth with Tying Platform 11 cm - 4 1/4" Tip Size 0.12 mm	1
37-724-10	Fechtner Conjunctival Forcep Very Delicate Ring Shaped Tips with Tying Platform 10.5 cm - 4"	1
37-816-10	Tennant Suture Tying Forcep Straight - Round Handle with Guide Pin - Extra Delicate Smooth Jaws 10.5 cm - 4" Jaws Length 6 mm	1
37-817-10	Tennant Suture Tying Forcep Curved - Round Handle with Guide Pin - Extra Delicate Smooth Jaws 10.5 cm - 4" Jaws Length 6 mm	1
37-801-10	Utrata Capsulorrhhexis Forcep Very Delicate Triangular Grasping Tips - Extremely Thin 10.5 cm - 4" Shanks Length 11 mm	1
37-784-10	Kelman-McPherson Suture Tying Forcep Angled - With Tying Platform 10 cm - 4" Jaws Length 7.5 mm	1
37-885-10	Livernois-McDonald IOL Inserting Forcep Concave Jaws 10.5 cm - 4" Jaws Length 5 mm	1
37-877-10	Livernois IOL Folding Forcep Concave Jaw Surfaces - For Soft IOLs 10.5 cm - 4"	1
78-315-11	Barraquer Micro Needle Holder Curved - Delicate - Round Handle - With Lock 11.5 cm - 4 1/2"	1
37-863-11	Ernest Nucleus Cracker Extra Delicate Cross Action Serrated Paddle Tips 11 cm - 4 1/4"	2
75-451-23	Simcoe Irrigation Aspirating Cannula Original Modle Gauge 23	1
75-475-25	Hydrodissection Cannula Angled at 8 mm - Flat Tip Gauge 25	1
75-421-27	Air Injection Cannula Angled at 5 mm Gauge 27	1
75-467-23	Jansen Capsul Polisher Cannula 23 Gauge	1
75-441-19	Stevens Sub Tenon's Anesthesia Cannula Gently Curved - Flat Tip Gauge 19	1
75-865-13	Fine-Thronton Swivel Fixation Ring With Swivel Handle 12 cm - 4 3/4" Tip Diameter 13 mm	1
75-465-23	McIntyre Cystotome Gauge 23	1
77-695-08	Vannas Capsulotomy Scissor Curved - Sharp Tips 8 cm - 3 1/4" Blade Size 5 mm	1
78-112-26	Storing Case Double Level 265 x 160 x 50 mm Plastic	1

**Phaco fracture Cataract Extraction Set**

Codes	Description	Quantity
75-085-15	Lieberman Eye Speculum Adjustable Blade Size 15 mm	1
77-440-11	Iris Scissor Straight 11.5 cm - 4 1/2"	1
77-675-11	Westcott Tenotomy Scissor Curved - Blunt Tips - Medium Blades 11 cm - 4 1/2"	1
37-750-01	Castroviejo Suture Tying Forcep 1 x 2 Teeth with Tying Platform 11 cm - 4 1/4" Tip Size 0.12 mm	1
75-206-13	Scalpel Handle For Micro Scalpel Blades 13 cm - 5"	1
75-210-69	A Micro Scalpel Blade No. 69A Pack of 25	1
75-232-15	Disposable Stab Knife Straight 15 Degree Cutting Edge Box of 6	1
34-850-20	Castroviejo Caliper Straight 8 cm - 3" Measuring Range 20 mm	1
37-801-10	Utrata Capsulorrhexis Forcep Very Delicate Triangular Grasping Tips - Extremely Thin 10.5 cm - 4" Shanks Length 11 mm	1
75-827-02	Kuglen Iris Hook and Lens Manipulator Push Pull Modle - Angled 11.5 cm - 4 1/2"	1
75-775-02	Alfonso Cutting Platform 12.5 cm - 5" Width 2 mm	1
75-775-03	Alfonso Cutting Platform 12.5 cm - 5" Width 3 mm	1
75-765-10	Alfonso Nucleus Trisector For Use With Ref:- 75-775-02 10.5 cm - 4 1/4" Width 1.5 mm	1
75-767-10	Bucher-Kansas Nucleus Trisector For Use With Ref:- 75-775-03 10.5 cm - 4 1/4" Width 2.5 mm	1
75-771-11	Kansas Nucleus Bisector 11.5 cm - 4 1/2" Stainless Steel	1
37-869-10	Alfonso Nucleus Grasping Forcep With Two Short Rows of Delicate Interlocking Teeth 10.5 cm - 4"	1
75-542-25	Alfonso Nucleus Irrigating Spoon 2.5 mm Wide	1
75-542-40	Alfonso Nucleus Irrigating Spoon 4.0 mm Wide	1
75-421-27	Air Injection Cannula Angled at 5 mm Gauge 27	1
75-525-21	Simcoe Cortex Extractor Smooth Closed Tip - 21 mm Long Gauge 21	1
37-875-11	Dodick IOL Folding Forcep For Soft IOLs 11 cm - 4 1/4"	1
37-889-10	Buratto Soft IOL Inserting Forcep Extra Delicate Highly Polished Convex Jaws 10 cm - 4"	1
78-112-26	Storing Case Double Level 265 x 160 x 50 mm Plastic	1

**Glaucoma (Optic Nerve Repair) Surgery Set**

Codes	Description	Quantity
75-471-19	Bishop-Harmon Anterior Chamber Irrigator Gauge 19	1
23-761-05	Jones Towel Clamp Sharp 5.5 cm - 2 1/4"	1
23-140-10	Hartmann Haemostatic Forcep Straight 10 cm - 4"	1
75-064-15	Murdoch Eye Speculum Blade Size 15 mm	1
75-010-15	Barraquer Wire Speculum Standard Wire Blade Size 15 mm	1
75-083-15	Lieberman Eye Speculum Adjustable Blade Size 15 mm	1
77-440-11	Iris Scissor Straight 11.5 cm - 4 1/2"	1
77-675-11	Westcott Tenotomy Scissor Curved - Blunt Tips - Medium Blades 11 cm - 4 1/2"	1
77-647-07	Barraquer Iris Scissor Angled 5.5 cm - 2 1/4" Blade Size 7 mm	1
77-707-10	Gills-Vannas Micro Scissor Curved - Sharp Tips - Extra Thin 10.5 cm - 4" Blade Size 7 mm	1
77-681-11	McPherson-Westcott Stitch Scissor Curved - Very Sharp Pointed Tips - Small Blades 11 cm - 4 1/2"	1
37-724-10	Fechtner Conjunctival Forcep Very Delicate Ring Shaped Tips with Tying Platform 10.5 cm - 4"	2
37-716-07	Colibri Corneal Forcep Very Delicate 1 x 2 Teeth 7.5 cm - 3 1/4" Tip Size 0.12 mm	1
37-760-08	Bishop-Harmon Iris Forcep Standard 1 x 2 Teeth 8.5 cm - 3 1/4"	1
75-919-09	Fechtner Trabeculectomy Marker 9 cm - 3 1/2"	1
34-850-20	Castroviejo Caliper Straight 8 cm - 3" Measuring Range 20 mm	1
75-206-13	Scalpel Handle For Micro Scalpel Blades 13 cm - 5"	2
75-230-02	Disposable Crescent Knife Angled Box of Six	1
75-210-69 A	Micro Scalpel Blade No. 69A Pack of 25	1
75-232-15	Disposable Stab Knife Straight 15 Degree Cutting Edge Box of 6	1
75-395-00	Luntz-Dodick Trabeculectomy Punch Complete With Punch Ref:- 75-455-01 Diameter - Deep Bite 1.0 mm - 0.5 mm	1
75-397-00	Kelly Descemet's Membrane Punch Diameter - Deep Bite 1.0 mm - 0.5 mm	1
75-587-13	Blumenthal Conjunctiva Dissector With Blunt Disc Shaped Tip 13 cm - 5"	1
78-321-13	Barraquer Micro Needle Holder Curved - Very Delicate - Round Handle 13 cm - 5"	1

**Glaucoma (Optic Nerve Repair) Surgery Set**

Codes	Description	Quantity
75-421-27	Air Injection Cannula Angled at 5 mm Gauge 27	1
75-941-01	Harms Trabeculotomy Probe Right 5 cm - 2"	1
75-941-02	Harms Trabeculotomy Probe Left 5 cm - 2"	1
78-112-26	Storing Case Double Level 265 x 160 x 50 mm Plastic	1

**LASIK Set**

Codes	Description	Quantity
75-083-15	Lieberman Eye Speculum Adjustable Blade Size 15 mm	1
75-083-15 A	Lieberman Eye Speculum With Aspirating Ports Adjustable Blade Size 15 mm	1
75-591-12	Buratto Lasik Flap Protector 12.5 cm - 5"	1
75-597-11	Mannis-Buratto Lasik Flap Protector Blades Angled 45° 11.5 cm - 4 1/2"	1
75-713-14	Hersh Flap Spatula 14 cm - 5 1/2"	1
75-717-12	Fukasaaku Lasik Spatula 12 cm - 4 3/4"	1
75-720-13	Katzen Lasik Flap Unzipper 13.5 cm - 5 1/4"	1
75-863-11	Gimbel Stabilization Ring With Swivel Handle 11.5 cm - 4 1/2" Tip Diameter 13 mm	1
75-887-11	Chayet Corneal Marker for LASIK Surgery 11.5 cm - 4 1/2"	1
37-793-10	Buratto LASIK Flap Forcep Curved - Disc Shaped Serrated Jaws 10.5 cm - 4"	1
75-507-25	Banaji Lasik Cannula With 6 Ports Gauge 25	1
75-495-26	Spatulated Lasik Cannula Flattened Spatulated Tip - End Opening Gauge 26	1
75-509-23	Buratto Lasik Cannula With 3 Ports - Slightly Flattened Gauge 23	1
78-110-03	Storing Case Large 265 x 160 x 25 mm Plastic	1

**LASEK Surgery Set**

Codes	Description	Quantity
75-083-15 A	Lieberman Eye Speculum With Aspirating Ports Adjustable Blade Size 15 mm	1
75-385-08	Camellin Lasek Trepine & Alcohol Retaining Well 12.5 cm - 5" Diameter 8 mm - 8.5 mm	1
75-385-09	Camellin Lasek Trepine & Alcohol Retaining Well 12.5 cm - 5" Diameter 9 mm - 9.5 mm	1
75-619-13	Sloane Lasek Micro Hoe & Epi Peeler 13.5 cm - 5 1/4"	1
75-627-12	Sloane Lasek Flap Repositor Gently Curved Spatulated Tip 12 cm - 4 3/4"	1
75-439-25	Lasek Alcohol Cannula Delicate Olive Shaped Tip Gauge 25	1
78-110-03	Storing Case Small 165 x 70 x 25 mm Plastic	1

**Chalazion Surgery Set**

Codes	Description	Quantity
75-192-11	Jaeger Lid Plate 11 cm - 4 1/4"	1
75-550-01	Meyerhoefer Chalazion Curette Size 1 12.5 cm - 5" Diameter 1.75 mm	1
75-550-02	Meyerhoefer Chalazion Curette Size 2 12.5 cm - 5" Diameter 2.25 mm	1
75-550-03	Meyerhoefer Chalazion Curette Size 3 12.5 cm - 5" Diameter 2.5 mm	1
75-550-04	Meyerhoefer Chalazion Curette Size 4 12.5 cm - 5" Diameter 3.5 mm	1
77-441-11	Iris Scissor Curved 11.5 cm - 4 1/2"	1
37-768-09	Manhattan Eye and Ear Fixation Forcep 1 x 2 Teeth with Tying Platform 9 cm - 3 1/2" Tip Size 0.3 mm	1
37-912-12	Hunt Chalazion Forcep Round Jaws 9.5 cm - 3 3/4" Jaw Diameter 12 mm Ø	1
37-916-09	Francis Chalazion Forcep Medium - Oval Jaws 9.5 cm - 3 3/4" Jaw Size 14 x 11 mm	1
78-211-14	Castroviejo Micro Needle Holder Curved - Delicate 14 cm - 5 1/2"	1
75-206-13	Scalpel Handle For Micro Scalpel Blades 13 cm - 5"	1
75-210-67	Micro Scalpel Blade No. 67 Pack of 25	1
78-110-03	Storing Case Large 265 x 160 x 25 mm Plastic	1

**Strabismus / Squint Surgery Set**

Codes	Description	Quantity
75-087-10	Lieberman Eye Speculum Adjustable - Solid Blades Blade Size 10 mm	1
75-087-15	Lieberman Eye Speculum Adjustable Blade Size 15 mm	1
23-141-10	Hartmann Haemostatic Forcep Curved 9.5 cm - 3 3/4"	2
23-062-03	Dieffenbach Bulldog Clamp Straight 3.5 cm - 1 1/2"	2
75-211-07	Helveston Tissue Retractor Thin Curved Blade 12.5 cm - 5" Blade Width 7 mm	1
75-211-09	Helveston Tissue Retractor Thin Curved Blade 12.5 cm - 5" Blade Width 9 mm	1
75-211-11	Helveston Tissue Retractor Thin Curved Blade 6.5 cm - 2 1/2" Blade Width 11 mm	2
75-873-12	Helveston Teaser Hook Extra Delicate - Blunt 12.5 cm - 5"	2
75-877-01	Helveston Finder Hook Large 12.5 cm - 5"	1
75-877-02	Helveston Finder Hook Small 12 cm - 4 3/4"	1
75-879-01	Helveston Muscle Hook Fig. 1 13 cm - 5" Tip Length 8 mm	1
75-879-02	Helveston Muscle Hook Fig. 2 13 cm - 5" Tip Length 10 mm	1
75-879-03	Helveston Muscle Hook Fig. 3 13 cm - 5" Tip Length 12 mm	1
75-930-12	Helveston Scleral Ruler 15 mm Long in Notches in 5 mm increments 12 cm - 4 3/4"	1
34-850-20	Castroviejo Caliper Straight 8 cm - 3" Measuring Range 20 mm	1
77-675-11	Westcott Tenotomy Scissor Curved - Blunt Tips - Medium Blades 11 cm - 4 1/2"	1
77-683-11	Westcott Stitch Scissor Curved - Very Sharp Pointed Tips - Standard Blades 11.5 cm - 4 1/2"	1
37-732-10	Bonn Corneal Forcep Very Delicate 1 x 2 Teeth with Tying Platform 10 cm - 4" Tip Size 0.12 mm	1
37-777-01	Moody Fixation Forcep Curved Right 11 cm - 4 1/4"	1
37-777-02	Moody Fixation Forcep Curved Left 11 cm - 4 1/4"	1
37-776-02	Lester Fixation Forcep Angled - 2 x 3 Teeth 9.5 cm - 3 3/4"	3
37-824-10	Helveston Suture Tying Forcep Straight 10.5 cm - 4"	1
75-881-02	Jameson Muscle Hook Large 13.5 cm - 5 1/4"	1
78-222-14	Castroviejo Micro Needle Holder Straight - Standard - With Lock 14 cm - 5 1/2"	1
78-323-13	Barraquer Micro Needle Holder Curved - Very Delicate - Round Handle - With Lock 13 cm - 5"	1
75-471-19	Bishop-Harmon Anterior Chamber Irrigator Gauge 19	1
75-206-13	Scalpel Handle For Micro Scalpel Blades 13 cm - 5"	1
75-210-69	Micro Scalpel Blade No. 69 Pack of 25	1
78-112-26	Storing Case Double Level 265 x 160 x 50 mm Plastic	1

**Lacrimal (Dacryocystorhinostomy) Surgery Set**

<b>Codes</b>	<b>Description</b>	<b>Quantity</b>
75-471-19	Bishop-Harmon Anterior Chamber Irrigator Gauge 19	1
23-773-08	Backhaus Towel Clamp 9 cm - 3 1/2"	2
23-160-12	Halsted-Mosquito Haemostatic Forcep Straight 12.5 cm - 5"	2
23-161-12	Halsted-Mosquito Haemostatic Forcep Curved 12 cm - 4 3/4"	2
74-305-03	Kerrison Sphenoid Punch Up Cutting 14 cm - 5 1/2" Bite size 3.0 x 3.0 mm	1
74-033-03	Hartmann-Halle Nasal Speculum Fig. 3 15.5 cm - 6" Blade Length 35 mm	1
67-937-16	Mead Bone Rongeur 16.5 cm - 6 1/2"	1
67-470-19	Cottle Bone Mallet Plain - Convex 19 cm - 7 1/2" Head Ø 30.0 mm - Weight 300 Grams	1
75-206-13	Scalpel Handle For Micro Scalpel Blades 13 cm - 5"	1
75-210-65	Micro Scalpel Blade No. 65 Pack of 25	1
75-220-00	Stevenson Lacrimal Sac Retractor 3 x 3 Blunt Pronges - Adjustable	1
75-410-23	Lacrimal Cannula Straight Gauge 23	1
75-411-23	Lacrimal Cannula Curved Gauge 23	1
75-950-14	Castroviejo Lacrimal Dilator Double Ended Fine and Meadium Taper 14 cm - 5 1/2"	1
74-475-18	Freer Septum Elevator Double Ended - Sharp/Blunt 18.5 cm - 7 1/4" Blade Size 1 - Blade Size 2 5.0 mm - 5.0 mm	1
74-604-16	West Septum Chisel 16 cm - 6 1/4"	1
74-601-16	Freer Septum Chisel Curved 16 cm - 6 1/4" Blade Width 4.0 mm	1
75-954-14	Worst Pigtail Probe With Hook 16 cm - 6 1/4"	1
75-956-14	Crawford Retrieval Hook 14.5 cm - 5 3/4"	1
75-960-00	Crawford Lacrimal Intubation Set Including 30.5 cm - 12" Silicone Tube and Two Olive Tip Probes Ø 0.6 mm	1
77-200-00	Bowman Probes Complete Set of 7	1
37-846-10	Gold Punctal Plug Forcep With Longitudinal Groove - Pointed Tips 11 cm - 4 1/4"	1
37-700-01	Graefe Eye Dressing Forcep 10 cm - 4"	1
37-766-09	Sauer Fixation Forcep 1 x 2 Teeth 9 cm - 3 1/2" Tip Size 0.3 mm	1
37-834-12	Bonaccolto Conjunctival Forcep Longitudinal Serrated Jaws with Cross Serrations at Tips 10.5 cm - 4" Tip Width 1.2 mm	1
37-750-03	Castroviejo Suture Tying Forcep 1 x 2 Teeth with Tying Platform 11 cm - 4 1/4" Tip Size 0.3 mm	1
78-068-13	Knapp Fine Wound Retractor 4 Blunt Pronges 13.5 cm - 5 1/4"	1
77-453-11	Stevens Tenotomy Scissor Curved - Blunt/Blunt 11 cm - 4 1/2"	1
77-440-11	Iris Scissor Straight 11.5 cm - 4 1/2"	1
78-213-14	Castroviejo Micro Needle Holder Curved - Delicate - With Lock 14 cm - 5 1/2"	1
77-683-11	Westcott Stitch Scissor Curved - Very Sharp Pointed Tips - Standard Blades 11.5 cm - 4 1/2"	1
77-679-11	Tibolt Punctal Scissor One Conically Shaped Blade with Micro Grooves and Textured Surface 11.5 cm - 4 1/2"	1
78-112-26	Storing Case Double Level 265 x 160 x 50 mm Plastic	1



**Enucleation / Evisceration Set**

Codes	Description	Quantity
75-078-00	Lester-Burch Eye Speculum Adjustable	1
23-161-12	Halsted-Mosquito Haemostatic Forcep Curved 12 cm - 4 3/4"	1
75-802-15	Wells Enucleation Spoon 15 cm - 6"	1
77-469-11	Enucleation Scissor Curved 11.5 cm - 4 1/2"	1
75-800-01	Bunge Evisceration Spoon Small 13.5 cm - 5 1/4"	1
75-800-02	Bunge Evisceration Spoon Small 14 cm - 5 1/2"	1
78-048-02	Graefe Nerve Hook Fig. 2 14 cm - 5 1/2"	1
77-452-11	Stevens Tenotomy Scissor Straight - Blunt/Blunt 11 cm - 4 1/2"	1
37-702-01	Graefe Dissecting Forcep 1 x 2 Teeth 10 cm - 4"	1
23-161-12	Halsted-Mosquito Haemostatic Forcep Curved 12 cm - 4 3/4"	1
78-110-03	Storing Case Large 265 x 160 x 25 mm Plastic	1

**Pterygium Excision Set**

Codes	Description	Quantity
75-206-13	Scalpel Handle For Micro Scalpel Blades 13 cm - 5"	1
75-210-64	Micro Scalpel Blade No. 64 Pack of 25	1
75-076-16	Lancaster Eye Speculum Adjustable Blade Size 16 mm	1
37-780-10	McPherson Suture Tying Forcep Straight - With Tying Platform 10 cm - 4" Jaws Length 5 mm	1
37-750-01	Castroviejo Suture Tying Forcep 1 x 2 Teeth with Tying Platform 11 cm - 4 1/4" Tip Size 0.12 mm	1
75-260-12	Gill Corneal Knife Curved Cutting Edge - Straight 12.5 cm - 5"	1
78-211-14	Castroviejo Micro Needle Holder Curved - Delicate 14 cm - 5 1/2"	1
77-440-11	Iris Scissor Straight 11.5 cm - 4 1/2"	1
77-430-10	Iris Scissor Straight 10 cm - 4"	1
37-834-12	Bonaccolto Conjunctival Forcep Longitudinal Serrated Jaws with Cross Serrations at Tips 10.5 cm - 4" Tip Width 1.2 mm	1
37-776-02	Lester Fixation Forcep Angled - 2 x 3 Teeth 9.5 cm - 3 3/4"	1
78-110-03	Storing Case Large 265 x 160 x 25 mm Plastic	1

**Scleral Buckling (Retinal Detachment) Set**

<b>Codes</b>	<b>Description</b>	<b>Quantity</b>
75-010-15	Barraquer Wire Speculum Standard Wire Blade Size 15 mm	1
34-850-20	Castroviejo Caliper Straight 8 cm - 3" Measuring Range 20 mm	1
75-160-14	Schocket Scleral Depressor Double End With Pocket Clip 14 cm - 5 1/2"	1
37-760-08	Bishop-Harmon Iris Forcep Standard 1 x 2 Teeth 8.5 cm - 3 1/4"	1
37-750-01	Castroviejo Suture Tying Forcep 1 x 2 Teeth with Tying Platform 11 cm - 4 1/4" Tip Size 0.12 mm	1
37-700-01	Graefe Eye Dressing Forcep 10 cm - 4"	1
37-781-10	McPherson Suture Tying Forcep Angled - With Tying Platform 10 cm - 4" Jaws Length 5 mm	1
37-716-07	Colibri Corneal Forcep Very Delicate 1 x 2 Teeth 7.5 cm - 3 1/4" Tip Size 0.12 mm	1
75-881-01	Jameson Muscle Hook Small 13 cm - 5"	1
78-333-14	Barraquer Micro Needle Holder Curved - Very Delicate - Round Handle - With Lock 14 cm - 5 1/2"	1
78-222-14	Castroviejo Micro Needle Holder Straight - Standard - With Lock 14 cm - 5 1/2"	1
34-880-15	Ruler Graduated in mm and inches 16.5 cm - 6 1/2" Measuring Range 150 mm	1
77-441-11	Iris Scissor Curved 11.5 cm - 4 1/2"	1
77-453-11	Stevens Tenotomy Scissor Curved - Blunt/Blunt 11 cm - 4 1/2"	1
77-683-11	Westcott Stitch Scissor Curved - Very Sharp Pointed Tips - Standard Blades 11.5 cm - 4 1/2"	1
23-062-03	Dieffenbach Bulldog Clamp Straight 3.5 cm - 1 1/2"	2
75-750-01	Lewis Lens Loop Small 13 cm - 5"	1
37-750-03	Castroviejo Suture Tying Forcep 1 x 2 Teeth with Tying Platform 11 cm - 4 1/4" Tip Size 0.3 mm	1
37-750-05	Castroviejo Suture Tying Forcep 1 x 2 Teeth with Tying Platform 11 cm - 4 1/4" Tip Size 0.5 mm	1
23-160-12	Halsted-Mosquito Haemostatic Forcep Straight 12.5 cm - 5"	2
37-903-01	Jameson Muscle Forcep Right - With Slide Lock 6 Teeth - Adult Size 10 cm - 4"	1
37-903-02	Jameson Muscle Forcep Left - With Slide Lock 6 Teeth - Adult Size 10 cm - 4"	1
37-784-10	Kelman-McPherson Suture Tying Forcep Angled - With Tying Platform 10 cm - 4" Jaws Length 7.5 mm	1
37-702-01	Graefe Dissecting Forcep 1 x 2 Teeth 10 cm - 4"	1
37-840-10	Nugent Utility Forcep Smooth Jaws 10.5 cm - 4"	1
23-755-09	Schaedel Towel Clamp Sharp 9 cm - 3 1/2"	2
75-875-13	Gass Retinal Detachment Hook With Oval Hole 13 cm - 5"	1
75-883-13	Green Muscle Hook 13 cm - 5"	1
75-849-01	Twist Hook Right 11 cm - 4 1/4"	1
78-333-14	Barraquer Micro Needle Holder Curved - Very Delicate - Round Handle - With Lock 14 cm - 5 1/2"	1
75-171-15	Schepens Orbital Retractor 15 cm - 6"	1
77-643-11	Wecker Iris Scissor Angled - Sharp/Blunt 11 cm - 4 1/2"	1
77-440-11	Iris Scissor Straight 11.5 cm - 4 1/2"	1
75-230-02	Disposable Crescent Knife Angled Box of 6	1
75-232-15	Disposable Stab Knife Straight 15 Degree Cutting Edge Box of 6	1
78-112-26	Storing Case Double Level 265 x 160 x 50 mm Plastic	1

**Blepharoplasty Set (Eyelid Surgery Set)**

Codes	Description	Quantity
34-880-15	Ruler Graduated in mm and inches 16.5 cm - 6 1/2" Measuring Range 150 mm	1
75-012-03	Scalpel Handle No. 3 Solid, cm-Graduation 12 cm - 4 3/4"	1
77-440-11 SC	SuperEdge™ Iris Scissor Straight 11.5 cm - 4 1/2"	1
77-441-11 SC	SuperEdge™ Iris Scissor Curved 11.5 cm - 4 1/2"	1
23-160-12	Halsted-Mosquito Haemostatic Forcep Straight 12.5 cm - 5"	2
23-161-12	Halsted-Mosquito Haemostatic Forcep Curved 12 cm - 4 3/4"	2
78-222-14	Castroviejo Micro Needle Holder Straight - Standard - With Lock 14 cm - 5 1/2"	2
77-243-12	Kilner Dissecting Scissor Curved 12 cm - 4 3/4"	1
78-074-02	Joseph Mucosa Hook 16.5 cm - 6 1/2" Width 2.0 mm	2
23-773-08	Backhaus Towel Clamp 9 cm - 3 1/2"	4
37-250-12	Adson Dissecting Forcep 1 x 2 Teeth 12 cm - 4 3/4"	1
78-120-14	Desmarres Lid Retractor 16 cm - 6 1/4" Blade Width 14.0 mm	1
34-850-20	Castroviejo Caliper Straight 8 cm - 3" Measuring Range 20 mm	1
37-760-08	Bishop-Harmon Iris Forcep Standard 1 x 2 Teeth 8.5 cm - 3 1/4"	1
78-110-02	Storing Case Medium 200 x 110 x 25 mm Plastic	1

**Ocuplasty Set (Eyelid Surgery Set)**

Codes	Description	Quantity
75-078-00	Lester-Burch Eye Speculum Adjustable	1
75-171-15	Schepens Orbital Retractor 15 cm - 6"	1
75-175-15	Desmarres Lid Retractor Thin Solid Blades - Size 2 13 cm - 5" Blade Width 15 mm	1
75-180-02	Scleral Shield Large (Pair) Blade Width 22 x 30 mm	1
75-192-11	Jaeger Lid Plate 11 cm - 4 1/4"	1
75-197-14	Wright Fascia Needle Oval Hole 14 cm - 5 1/2" Width - Length 1 x 6 mm	1
78-068-13	Knapp Fine Wound Retractor 4 Blunt Prongs 13.5 cm - 5 1/4"	1
75-550-03	Meyerhoefer Chalazion Curette Size 3 12.5 cm - 5" Diameter 2.5 mm	1
75-800-02	Bunge Evisceration Spoon Small 14 cm - 5 1/2"	1
75-845-02	Fixation Hook Large (Sharp) 13 cm - 5"	1
78-048-02	Graefe Nerve Hook Fig. 2 14 cm - 5 1/2"	1
34-880-15	Ruler Graduated in mm and inches 16.5 cm - 6 1/2" Measuring Range 150 mm	1
77-452-11	Stevens Tenotomy Scissor Straight - Blunt/Blunt 11 cm - 4 1/2"	1
77-469-11	Enucleation Scissor Curved 11.5 cm - 4 1/2"	1
37-702-01	Graefe Dissecting Forcep 1 x 2 Teeth 10 cm - 4"	1
37-906-10	Putterman Mullers Muscle Conjunctival Resection Ptosis Clamp - With Side Lock 10.5 cm - 4"	1
37-916-09	Francis Chalazion Forcep Medium - Oval Jaws 9.5 cm - 3 3/4" Jaw Size 14 x 11 mm	1
37-910-09	Downes Lid Clamp 9.5 cm - 3 3/4"	1
23-140-10	Hartmann Haemostatic Forcep Straight 10 cm - 4"	1
78-222-14	Castroviejo Micro Needle Holder Straight - Standard - With Lock 14 cm - 5 1/2"	1
74-475-18	Freer Septum Elevator Double Ended - Sharp/Blunt 18.5 cm - 7 1/4" Blade Size 1 - Blade Size 2 5.0 mm - 5.0 mm	1
74-604-16	West Septum Chisel 16 cm - 6 1/4"	1
75-948-02	Wilder Lacrimal Dilator Medium Taper - Size 2 10.5 cm - 4 1/4"	1
77-204-34	Bowman Probe Fig. 3/4 13 cm - 5" Tip Diameter 1.3 mm - 1.4 mm	1
75-954-14	Worst Pigtail Probe With Hook 16 cm - 6 1/4"	1
75-012-03	Scalpel Handle No. 3 Solid, cm-Graduation 12 cm - 4 3/4"	1
75-100-11	Scalpel Blade No. 11 Pack of 100	1
75-100-13	Scalpel Blade No. 15 Pack of 100	1
78-112-26	Storing Case Double Level 265 x 160 x 50 mm Plastic	1

**23 G Vitreoretinal Set**

<b>Codes</b>	<b>Description</b>	<b>Quantity</b>
75-091-16	Castroviejo Eye Speculum Adjustable Mechanism Blade Size 16 mm	1
23-062-03	Dieffenbach Bulldog Clamp Straight 3.5 cm - 1 1/2"	4
23-160-12	Halsted-Mosquito Haemostatic Forcep Straight 12.5 cm - 5"	2
77-440-11	Iris Scissor Straight 11.5 cm - 4 1/2"	1
75-471-19	Bishop-Harmon Anterior Chamber Irrigator Gauge 19	1
77-452-11	Stevens Tenotomy Scissor Straight - Blunt/Blunt 11 cm - 4 1/2"	1
77-453-11	Stevens Tenotomy Scissor Curved - Blunt/Blunt 11 cm - 4 1/2"	1
77-675-11	Westcott Tenotomy Scissor Curved - Blunt Tips - Medium Blades 11 cm - 4 1/2"	1
77-683-11	Westcott Stitch Scissor Curved - Very Sharp Pointed Tips - Standard Blades 11.5 cm - 4 1/2"	1
75-206-13	Scalpel Handle For Micro Scalpel Blades 13 cm - 5"	1
75-210-64	Micro Scalpel Blade No. 64 Pack of 25	1
75-234-19	Disposable MVR Knife Straight 19 Ga Box of 6	1
75-171-15	Schepens Orbital Retractor 15 cm - 6"	1
78-048-02	Graefe Nerve Hook Fig. 2 14 cm - 5 1/2"	1
75-875-13	Gass Retinal Detachment Hook With Oval Hole 13 cm - 5"	1
75-160-14	Schocket Scleral Depressor Double End With Pocket Clip 14 cm - 5 1/2"	1
34-850-20	Castroviejo Caliper Straight 8 cm - 3" Measuring Range 20 mm	1
75-151-01	Gass Scleral Marker Tip Diameter 1.5 mm	1
37-907-11	Watzke Sleeve Spreading Forcep 11.5 cm - 4 1/2" Jaws Length 10 mm	1
37-834-12	Bonaccolto Conjunctival Forcep Longitudinal Serrated Jaws with Cross Serrations at Tips 10.5 cm - 4" Tip Width 1.2 mm	1
37-840-10	Nugent Utility Forcep Smooth Jaws 10.5 cm - 4"	1
37-750-01	Castroviejo Suture Tying Forcep 1 x 2 Teeth with Tying Platform 11 cm - 4 1/4" Tip Size 0.12 mm	1
37-750-03	Castroviejo Suture Tying Forcep 1 x 2 Teeth with Tying Platform 11 cm - 4 1/4" Tip Size 0.3 mm	1
37-760-08	Bishop-Harmon Iris Forcep Standard 1 x 2 Teeth 8.5 cm - 3 1/4"	2
78-213-14	Castroviejo Micro Needle Holder Curved - Delicate - With Lock 14 cm - 5 1/2"	1
78-212-14	Castroviejo Micro Needle Holder Straight - Delicate - With Lock 14 cm - 5 1/2"	1
37-780-10	McPherson Suture Tying Forcep Straight - With Tying Platform 10 cm - 4" Jaws Length 5 mm	1
75-211-07	Helveston Tissue Retractor Thin Curved Blade 12.5 cm - 5" Blade Width 7 mm	1
75-211-09	Helveston Tissue Retractor Thin Curved Blade 12.5 cm - 5" Blade Width 9 mm	1
75-429-22	Viscoelastic Aspirating Cannula Angled at 10 mm Gauge 22	1
75-427-19	Randolph Cyclodialysis Cannula Flat Tip Gauge 19	1
75-934-35	Braunstein Caliper 3.5 / 4.0 mm	1
77-721-23	Virectomy Scissor Curved - Horizontal Opening 23 G	1
37-680-23	Virectomy Forcep Straight Horizontal Opening - Serrated Tips 23 G	1
37-682-23	Virectomy Forcep Straight End Gripping Jaws Horizontal Opening Tips 23 G	1
37-689-23	Virectomy Forcep Straight Asymmetrical Jaws 23 G	1
37-690-23	ILM Virectomy Forcep Straight 23 G	1
78-112-26	Storing Case Double Level 265 x 160 x 50 mm Plastic	1

**Micro Incision Cataract Surgery (MICS) Surgery Set**

Codes	Description	Quantity
75-357-18	MICS Diamond Knife Angled Trapezoid Cutting Edge 12 cm - 4 3/4" Blade Width 1.8 to 2.2 mm Titanium Handle	1
75-735-12	Alio-Kelman IOL Hook 12 cm - 4 3/4" Tip Diameter 0.2 mm	1
77-725-23	Alio MICS Virectomy Scissor Straight Horizontal Opening With Curved Shaft 23 G	1
37-695-23	Alio MICS Virectomy Capsulorrhexis Forcep Angled Shaft 23 G	1
37-807-11	Inamura Capsulorrhexis Forcep Delicate Tapered Shanks 11.5 cm - 4 1/2" Shanks Length 12 mm	1
37-863-11	Ernest Nucleus Cracker Extra Delicate Cross Action Serrated Paddle Tips 11 cm - 4 1/4"	1
75-549-01 T	Irrigation Handpiece For Bimanual Technique 2 x 0.5 mm (21G) Side Ports 10.5 cm - 4" Titanium	1
75-549-02 T	Aspiration Handpiece For Bimanual Technique 2 x 0.5 mm (21G) Side Ports 10.5 cm - 4" Titanium	1
78-110-02	Storing Case Medium 200 x 110 x 25 mm Plastic	1

**Deep Anterior Lamellar Keratoplasty (DALK) Set**

Codes	Description	Quantity
75-083-15	Lieberman Eye Speculum Adjustable Blade Size 15 mm	1
75-629-01	DALK Corneal Dissector 12 mm Long Flat Vaulted Spatula With Vaulted Tip 12.5 cm - 5"	1
75-629-02	Rosenwasser DALK Trisector 10 mm Long Triangular Shaft With Spatula Shaped Tip 12.5 cm - 5"	1
75-629-03	Bonfadini DALK Spatula Vaulted 1.0 mm Wide 8 mm Spatula Shaped Blade With Central Groove 12.5 cm - 5"	1
77-649-01	Holland DALK Scissor With Inner Spatulated Blade Curved Right 10.5 cm - 4"	1
77-649-02	Holland DALK Scissor With Inner Spatulated Blade Curved Left 10.5 cm - 4"	1
77-705-08	Holland DALK Scissor Angled Blade With Blunt Tips 8 cm - 3 1/4"	1
75-417-27	DALK Air Injection Cannula Vaulted Shank With Flattened Tip Gauge 27	1
75-419-27	Rosenwasser DALK Air Injection Cannula Flattened Cobra Shaped Tip Gauge 27	1
37-816-10	Tennant Suture Tying Forcep Straight - Round Handle with Guide Pin - Extra Delicate Smooth Jaws 10.5 cm - 4" Jaws Length 6 mm	1
37-817-10	Tennant Suture Tying Forcep Curved - Round Handle with Guide Pin - Extra Delicate Smooth Jaws 10.5 cm - 4" Jaws Length 6 mm	1
78-313-11	Barraquer Micro Needle Holder Curved - Delicate - Round Handle 11.5 cm - 4 1/2"	1

# OPHTHALMIC INSTRUMENTS CATALOGUE



**SUNMARK**  
I N S T R U M E N T S

*Mark Of Quality*

## Our Range of Best Selling Instruments

Ophthalmic Surgery Instruments ◆ Augenheilkunde Instrumente ◆ Oftalmologia cirugía Instrumentos

Ophthalmique chirurgie Instruments ◆ Oftalmica chirurgia Strumenti

+92 (331) 661 9646

www.sunmarkinstruments.com

sales@sunmarkinstruments.com

Small Industrial Estate Sialkot-51310 Punjab Pakistan

