

SUNMARK
INSTRUMENTS

Mark Of Quality

CARDIOVASCULAR INSTRUMENTS CATALOGUE

Cardiovascular Instruments ◆ Herz - Kreislauf - Instrumente ◆ Instrumentos cardiovasculares
Instruments cardiovasculaires ◆ Strumenti cardiovascolari

INSTRUCTIONS FOR REPROCESSING OF REUSABLE SURGICAL INSTRUMENTS

The following instructions are for all reusable medical devices supplied by Sunmark Instruments Ltd, unless stated otherwise with the packaging of the product. These instructions are intended for use only by persons with the required specialist knowledge and training.

Warnings

- Follow instructions and warnings as issued by the manufacturers of any decontaminants, disinfectants and cleaning agents. Wherever possible avoid use of mineral acids and harsh, abrasive agents.
- No part of the process shall exceed 140 °C.
- Some sensitive materials (e.g. Aluminium) are damaged by high alkaline solutions (pH>10).
- Devices with long, narrow cannula, hinges and blind holes require particular attention during cleaning.

Note: When reprocessing medical devices, always handle with care, wearing protective clothing, gloves and eye-wear in accordance with local health & safety procedures.

Limitations on Reprocessing

- Repeated processing has minimal effect on these instruments.
- End of life normally determined by wear and damage in use.
- Any specific limitations on the number of reprocessing cycles shall be made available with instrument.

From Point of Use

Whenever possible, do not allow blood, debris or bodily fluids to dry on instruments. For best results and to prolong the life of the medical device reprocess immediately after use. If they cannot be reprocessed immediately, use an enzymatic foam spray cleaner to help prevent soil from drying.

Preparation for Decontamination

- Process all the instruments as soon as it is reasonably practical following use.
- Disassemble only where intended, without the use of tools unless specifically provided by the manufacturer. Instructions for dis assembly are available with the device, where required.

Cleaning: Automated

- Use only either CE marked or validated washer-disinfector machines and low foaming, non-ionizing cleaning agents and detergents following the manufacturer's instructions for use, warnings, concentrations and recommended cycles.
- Load instruments carefully, with any box joints and hinges open and so that any fenestration in instruments can drain.
- Place heavy instruments with care in the bottom of containers, taking care not to overload wash baskets.
- Place instruments with concave surfaces facing down to prevent pooling of water.
- Where possible, use appropriate attachments to flush inside reamers and devices with lumens or cannula.
- Ensure that soft, high purity water which is controlled for bacterial endo-toxins is used in the final rinse stage.

Note: Automated cleaning may not be suitable for all lumens and cannula in which case clean manually with a water jet gun, if available, and an appropriate brush (and stilette if provided) that reaches the depth of the feature. After manually cleaning, pass all devices through an automatic cleaning cycle to achieve disinfection.

Note: These instruments have been validated using a washer-disinfector cycle validated to include two cold rinses at <35 °C, a detergent cycle and a rinse cycle both at >50°C, a disinfection cycle operating at a temperature of between 80 °C and 90 °C for a minimum holding time of 1 minute (actual holding time in excess of 2 minutes 50 seconds) and a 20 minute drying cycle. The detergent used was low foaming, non-ionizing spray wash detergent cleaner (max 12pH) and the rinse aid a neutral pH low foaming, non-ionic surfactant with isopropyl alcohol.

Cleaning: Manual

- Manual cleaning is not advised if an automatic washer-disinfector is available. If the equipment is not available, use the following process:-
1. Use a double sink system (wash/rinse) dedicated for instrument cleaning (not used for hand washing). Ensure that the water temperature does not exceed 35 of the re-processor to ensure that the reprocessing as actually performed using equipment, materials and personnel in the reprocessing facility achieve the desired result. This requires validation and routine monitoring of the process. Likewise any deviation by the re-processor from the instructions provided must be properly evaluated for effectiveness and potential adverse consequences.
 2. In the first sink, keeping the instrument submerged, with an autoclavable brush, apply CE marked cleaning solution to all surfaces until all soil has been removed. Pay particular attention to serrations, teeth, ratchets and hinges, always brushing away from the body and avoiding splashing. Ensure rongeurs and hinged instruments are thoroughly cleaned in both open and closed positions.
 3. In the second sink, rinse instruments thoroughly with soft, high purity water which is controlled for bacterial endotoxins, so that the water reaches all parts of the instrument, then carefully hand dry or use a drying cabinet.

Note: Manual Cleaning is NOT a disinfection process: When manual cleaning is used it may not be possible to disinfect the device prior to further handling.

Cleaning Inspection

- After cleaning visually inspect, visually inspect all surfaces, cannulations, ratchets, joints, holes and lumens for complete removal of soil and fluids. If ANY soil or fluid is still visible, return the instrument for repeat decontamination.

Maintenance

- Apply surgical grade lubricant to hinges, joints and moving parts as per the lubricant manufacturer's instructions.

Continued on next page

Inspection and Functional Testing

- Visually inspect and check: - all instruments for damage and wear; cutting edges are free from nicks and present a continuous edge; jaws and teeth align correctly; all articulated instruments have a smooth movement without excess play; locking mechanisms (such as ratchets) fasten securely and close easily; long, slender instruments are not distorted; any component parts fit and assemble correctly with mating components.
- Remove for repair and replacement any blunt, worn out, flaking, fractured or damaged instruments.

Note: If an instrument is returned to the manufacturer / supplier, the instrument must be decontaminated and sterilized and be accompanied with the relevant documented evidence.

Packaging

- All instruments to be packed following local protocol in accordance with ISO 11607-1 or AAMI/CSR technique.

Sterilization (USA)

- Autoclave should comply with the requirements of, and be validated and maintained in accordance with ANSI/AAMI ST79.
- Pre-Vacuum moist heat sterilization operating at temperature 132 °C bar for a minimum holding time of 4 minutes always following the instructions of the machine manufacturer.
- When sterilizing multiple instruments in one autoclave cycle, ensure that the sterilizer manufacturers stated maximum load is not exceeded.
- Ensure instruments are dry before sterilization.

Sterilization (Outside USA)

- Autoclave should comply with the requirements of, and be validated and maintained in accordance with EN 285, EN 13060, EN ISO 17665.
- Either CE marked or validated vacuum autoclave operating at 134-137 °C bar for a minimum holding time of 3 minutes always following the instructions of the machine manufacturer.
- When sterilizing multiple instruments in one autoclave cycle, ensure that the sterilizer manufacturers stated maximum load is not exceeded.

Storage

- Ensure instruments are dry before storage, and stored in dry, clean conditions at an ambient room temperature.

Additional Information

- Other forms of cleaning (i.e. ultrasonic) and sterilization (i.e. Low temperature steam and Formaldehyde, Ethylene Oxide and Gas Plasma) are available. However, always follow the instructions for use as issued by the manufacturer and always consult with them if in any doubt over the suitability of any process used.
- Cleaning and sterilizing guidelines are available in HTM 2030 and HTM 2010. Contact: The NHS Estates Stationers Office Publications Cent for details at www.tsonline.gov.uk. For further information contact: NHS Estates Information Center, Department of Health, 1 Trevelyan Square, Boar Lane, Leeds, LS1 6AE, UK or visit www.nhsestates.gov.uk.

Note: It is the responsibility of the re-processor to ensure that the reprocessing as actually performed using equipment, materials and personnel in the reprocessing facility achieve the desired result. This requires validation and routine monitoring of the process. Likewise any deviation by the re-processor from the instructions provided must be properly evaluated for effectiveness and potential adverse consequences.



Rib Shears
Rippenscheren
Costótomos
Costotomes
Costotomi



28-010-23
Bone Shear
Overall Length 23 cm (9")



28-013-22
Rib Shear
Overall Length 23 cm (9")



28-017-22
Gluck Rib Shear
Drawing Cut
Overall Length 21 cm (8 ¼")

Rib Shears
Rippenscheren
Costótomos
Costotomes
Costotomi



Bethune Rib Shear

28-026-29
Overall Length 29 cm (11 ½")

28-026-34
Overall Length 34 cm (13 ½")



28-029-24
Vermeiren (Tudor-Edwards) Costotome
Overall Length 24 cm (9 ½")



28-031-26
Sauerbruch Bone Shear
Overall Length 26 cm (10 ¼")



28-033-21
Schumacher Rib Shear
Overall Length 21 cm (8 ½")

Rib Shears, Sternum Chisel
 Rippenscheren, Sternummeißel
 Costótomos, Cincel para esternón
 Costotomes, Ciseau-burin à sternum
 Costotomi, Scalpello per sterno



28-037-27
Giertz-Stille Rib Shear
 Overall Length 24.5 cm (9 3/4")

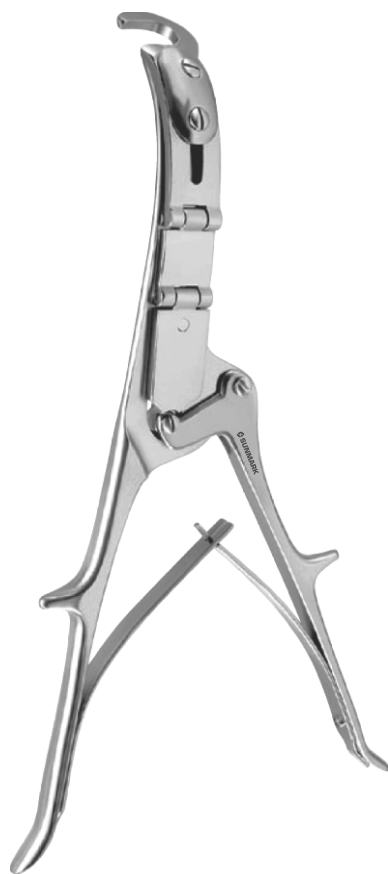

Brunner Rib Shear
 Overall Length 32 cm (12 1/2")

28-047-28
 For Right Hand

28-049-28
 For Left Hand



28-051-24
Lebsche Sternum Chisel
 Overall Length 24.5 cm (9 3/4")

Rib Retractors
Rippensperrer
Separadores costales
Ecarteurs des côtes
Divaricatori costali

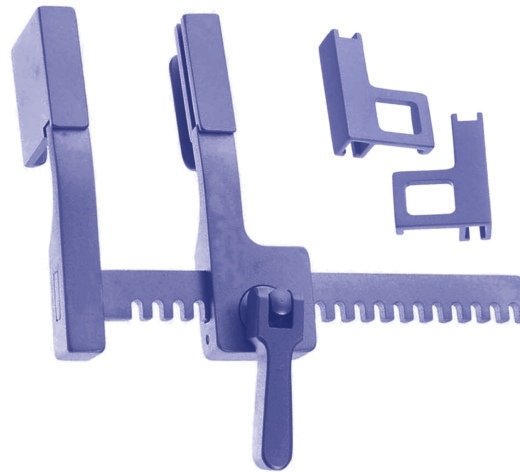
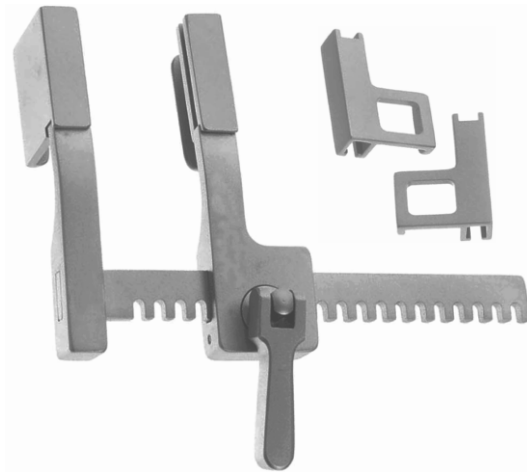
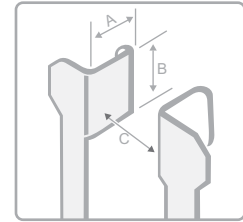

28-058-00
Rib Shear
For Babies, Two Pairs of Lateral Blades

A	B	C
9 x 20 mm	9 x 10 mm	52 mm

28-058-00 T
Rib Shear
For Babies, Two Pairs of Lateral Blades, Titanium

A	B	C
9 x 20 mm	9 x 10 mm	52 mm



Cooley Rib Spreader
For Babies, Aluminium

Code	A	B	C
28-060-01	12 mm	16 mm	95 mm

Cooley Rib Spreader
For Children, Aluminium

Code	A	B	C
28-060-02	15 mm	30 mm	140 mm
28-060-03	21 mm	44 mm	150 mm

Cooley Rib Spreader
For Adult, Aluminium

Code	A	B	C
28-060-04	35 mm	50 mm	200 mm

Rib Retractors
Rippensperrer
Separadores costales
Ecarteurs des côtes
Divaricatori costali

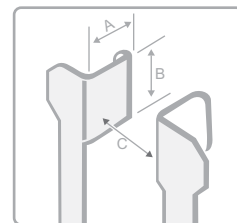

28-071-01
Finochietto-Infant Rib Spreader
For Babies, Aluminium

A	B	C
15 mm	15 mm	75 mm



28-072-01
Finochietto-Infant Rib Spreader
For Children, Aluminium

A	B	C
31 mm	31 mm	100 mm



Finochietto Rib Spreader
For Adults, Aluminium

Code	A	B	C
28-073-01	40 mm	45 mm	135 mm
28-073-02	52 mm	62 mm	175 mm
28-073-03	85 mm	65 mm	175 mm



Rib Retractors
 Rippensperrer
 Separadores costales
 Ecarteurs des côtes
 Divaricatori costali

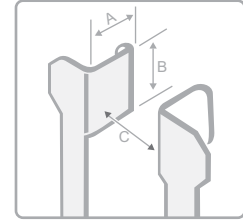

28

OPHTHALMIC SURGERY INSTRUMENTS



Burford Rib Spreader

With 2 Pairs of Lateral Blades, Aluminium

Code	A	B	C
28-075-01	47 x 62 mm	65 x 62 mm	200 mm
28-075-02	47 x 62 mm	65 x 62 mm	260 mm
28-075-03	47 x 62 mm	65 x 62 mm	300 mm



28-077-01

Castaneda Rib Spreader

For Babies, Aluminium

A	B	C
10.5 mm	32 mm	65 mm



Castaneda Rib Spreader

For Infant, Aluminium

Code	A	B	C
28-077-02	12 mm	45 mm	70 mm
28-077-03	15 mm	60 mm	120 mm

Rib Retractors
 Rippensperrer
 Separadores costales
 Ecarteurs des côtes
 Divaricatori costali

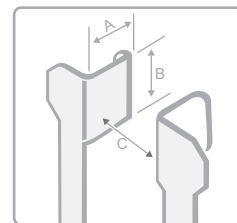

28-081-01
Finochietto (Modif) Rib Spreader
 Aluminium

A	B	C
14 mm	15 mm	120 mm



28-086-90
Haight Rib Spreader
 Aluminium

A	B	C
30 mm	30 mm	120 mm



28-091-01
Morse-Favaloro Rib Spreader
 For Children, 4 Moveable Blades

A	B	C
17 mm	22 mm	160 mm



Rib Retractors
 Rippensperrer
 Separadores costales
 Ecarteurs des côtes
 Divaricatori costali

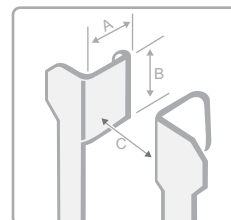

Morse Rib Spreader
 For Adults, 4 Moveable Blades

Code	A	B	C
28-094-00	22 mm	27 mm	200 mm
28-094-03	42 mm	28 mm	210 mm
28-094-04	55 mm	28 mm	210 mm



28-096-00
Tuffier Rib Spreader

A	B	C
45 mm	45 mm	160 mm



28-098-03
Ronald Edward Rib Spreader

A	B	C
65 mm	75 mm	245 mm

Rib Retractors
 Rippensperrer
 Separadores costales
 Ecarteurs des côtes
 Divaricatori costali



28-101-00
Finochietto-Baby Rib Spreader

A	B	C
14 mm	15 mm	75 mm



Finochietto Rib Spreader

	A	B	C
28-102-01	40 mm	45 mm	150 mm
28-102-02	46 mm	62 mm	190 mm
28-102-03	80 mm	65 mm	190 mm

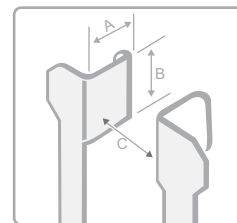

DeBakey Rib Spreader
 Complete

DeBakey Rib Spreader Only

A	B	C
28-105-00		150 mm
28-105-01		150 mm



28-105-02
DeBakey Lateral Blades Pair (Fig. 1)
 30 x 30 mm



28-105-03
DeBakey Lateral Blades Pair (Fig. 2)
 40 x 40 mm



28-105-04
DeBakey Lateral Blades Pair (Fig. 3)
 50 x 50 mm



Rib Retractors
 Rippensperrer
 Separadores costales
 Ecarteurs des côtes
 Divaricatori costali

28

THORAX, CARDIOVASCULAR SURGERY

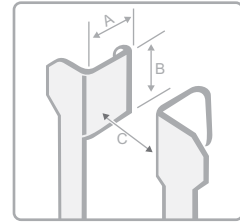
28-106-00
DeBakey Rib Spreader Complete

With 3 Pairs of Blades Ref: 28-106-02 to 28-106-04

A	B	C
		200 mm

28-106-01
DeBakey Rib Spreader Only

A	B	C
		200 mm

28-106-02
Lateral Blades Pair

(Fig. 1)

60 x 60 mm

28-106-03
Lateral Blades Pair

(Fig. 2)

50 x 80 mm

28-106-04
Lateral Blades Pair

(Fig. 3)

40 x 100 mm

28-106-05
Lateral Blades Pair

(Fig. 4)

80 x 60 mm

28-106-06
Lateral Blades Pair

(Fig. 4)

50 x 66 mm

Rib Retractors
 Rippensperrer
 Separadores costales
 Ecarteurs des côtes
 Divaricatori costali

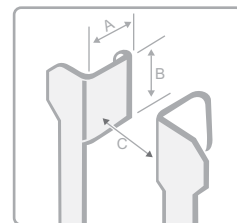

28-111-00
Mercedes Thoracic Retractor Complete
 With Lateral Blades Ref: 28-111-02 to 28-111-03

A	B	C
		200 mm



28-111-01
Mercedes Thoracic Retractor Only

A	B	C
		200 mm



28-111-02
Lateral Blades
 (Fig. 1)
 48 x 68 mm



28-111-03
Lateral Blades
 (Fig. 2)
 70 x 75 mm

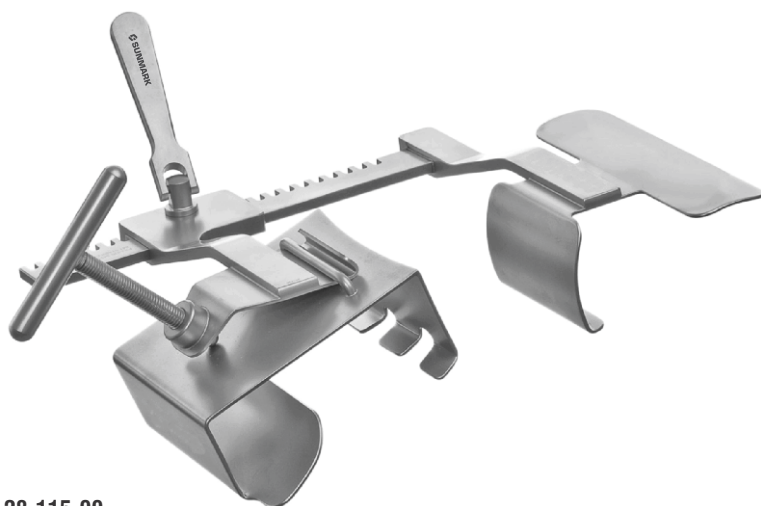

Rib Retractors
 Rippensperrer
 Separadores costales
 Ecarteurs des côtes
 Divaricatori costali

28-115-00

I.M.A Mammaria Retractor
 Complete

A	B	C
40 mm	150 mm	110 mm

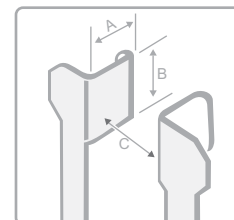
28-117-00

I.M.A Sternal Retractor French Pattern Standard
 Complete

Including 1 x 28-117-10, 1 x 28-117-90, 1 x Each of
 28-117-28 and 28-117-32

A	B	C
55 mm	100 mm	170 mm

28-117-10

I.M.A Sternal Retractor French Pattern Standard
 Frame Only

A	B	C
55 mm	100 mm	170 mm

Rib Retractors
Rippensperrer
Separadores costales
Ecarteurs des côtes
Divaricatori costali

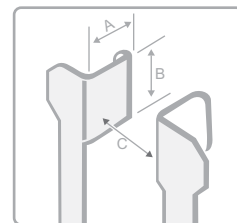

28-117-28

I.M.A Sternal Retractor Claw Blade
28 mm Deep

28-117-32

I.M.A Sternal Retractor Claw Blade
32 mm Deep

28-117-38

I.M.A Sternal Retractor Claw Blade
38 mm Deep

28-117-43

I.M.A Sternal Retractor Claw Blade
43 mm Deep

28-117-50

I.M.A Sternal Retractor Claw Blade
50 mm Deep

28-117-90

I.M.A Sternal Retractor U Shaped Blade
100 x 20 mm

28-117-91

I.M.A Sternal Retractor U Shaped Blade
100 x 25 mm

28-117-92

I.M.A Sternal Retractor U Shaped Blade
30 x 20 mm



28-118-00

I.M.A Sternal Retractor French Pattern Ministernotomy Complete
Complete
Including 1 x 28-118-10, 1 x 28-117-92, 1 x Each of 28-117-43 and 28-117-50

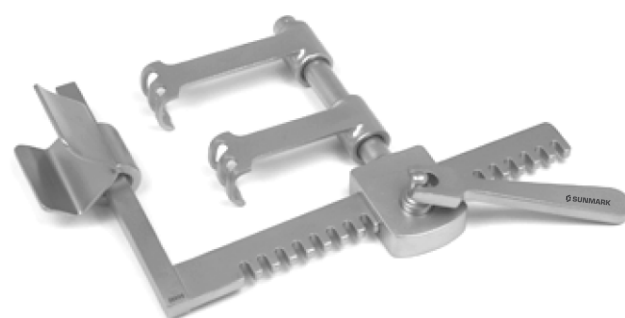

28-118-10

I.M.A Sternal Retractor French Pattern Ministernotomy Complete
Frame Only

A	B	C
55 mm	100 mm	170 mm

A	B	C
55 mm	100 mm	170 mm

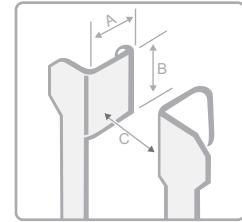

Rib Retractors
 Rippensperrer
 Separadores costales
 Ecarteurs des côtes
 Divaricatori costali

28-120-00
Mitral Valve Retractor Set
 Complete With Accessories

Includes

- 1 x 28-120-10 Mitral Valve Retractor Attachment Main Bracket
- 3 x 28-120-11 Universal Clamp for Mounting Blades to Mitral Valve Retractor
- 1 x 28-120-12 Mitral Valve Retractor Attachment Side Arm Bar
- 3 x 28-120-15 Small Retractor Blade for Mitral Valve Retractor 24 x 75 mm
- 1 x 28-120-14 Large Retractor Blade for Mitral Valve Retractor 34 x 74 mm
- 1 x 28-120-13 Tricuspid Retractor Blade for Mitral Valve Retractor 44 x 60 mm
- 1 x 28-120-90 Cooley Type Frame For Mitral Valve Retractor 40 x 110 mm

Accessories

28-120-10

Mitral Valve Retractor Attachment Main Bracket

28-120-12

Mitral Valve Retractor Attachment Side Arm Bar

28-120-14

Large Retractor Blade for Mitral Valve Retractor 34 x 74 mm

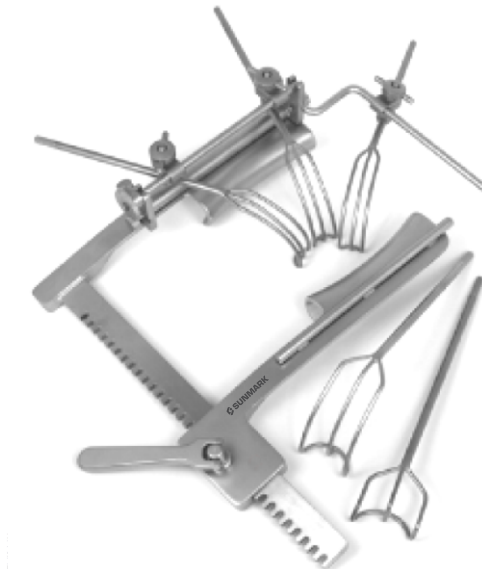
28-120-11

Universal Clamp for Mounting Blades to Mitral Valve Retractor



28-120-13

Tricuspid Retractor Blade for Mitral Valve Retractor 44 x 60 mm

28-120-15

Small Retractor Blade for Mitral Valve Retractor 24 x 75 mm

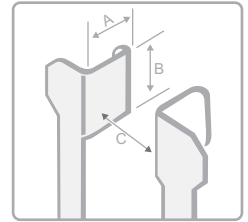
Rib Retractors
Rippensperrer
Separadores costales
Ecarteurs des côtes
Divaricatori costali



28-120-20

Suture Bar For Mitral Valve Retractor (Optional)



28-120-90

Cooley Type Frame For Mitral Valve Retractor 40 x 110 mm



Rib Contractors
Rippenkontraktoren
Aproximadores para costillas
Rapprocheurs des côtes
Approssimatori costali



28-150-20
Sellers Rib Contractor
Overall Length 20 cm (8")



28-154-15
Bailey-Baby Rib Contractor
Overall Length 15.5 cm (6")



28-158-16
Bailey Rib Contractor
Short Claws
Overall Length 20 cm (8")



28-160-16
Bailey-Gibbon Rib Contractor
Long Claws
Overall Length 20 cm (8")

Rib Contractors
Rippenkonraktoren
Aproximadores para costillas
Rapprocheurs des côtes
Approssimatori costali



28-166-22

Gaubatz Rib Contractor

With 60 mm Deep Blades
Overall Length 22 cm (8 1/2")

28-166-29

Gaubatz Rib Contractor

With 85 mm Deep Blades
Overall Length 29 cm (11 1/2")

Lung Spatulas
Lungenspatel
Espátulas pulmonares
Spatules pulmonaires
Spatole per pulmone



28-171-30
Allis Lung Spatula
Overall Length 29.5 cm (11 ½")

28-171-32
Overall Length 32.5 cm (12 ¾")

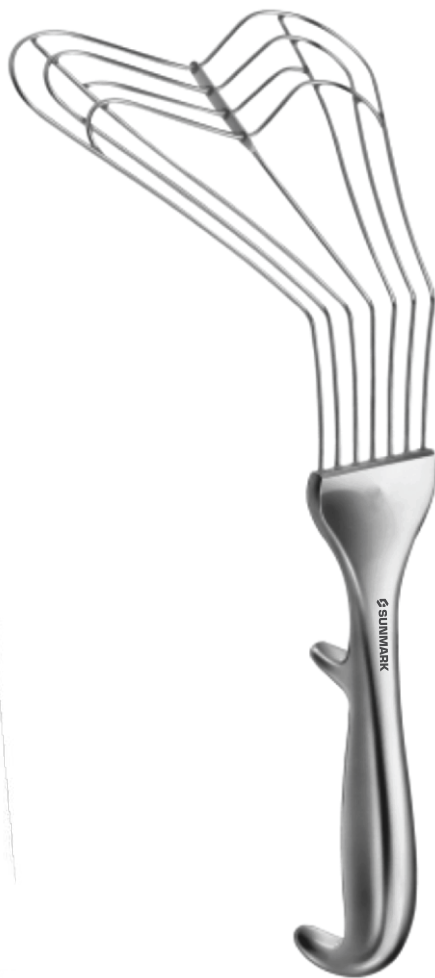

28-173-30
Allis Lung Spatula
Overall Length 26 cm (10 ¼")

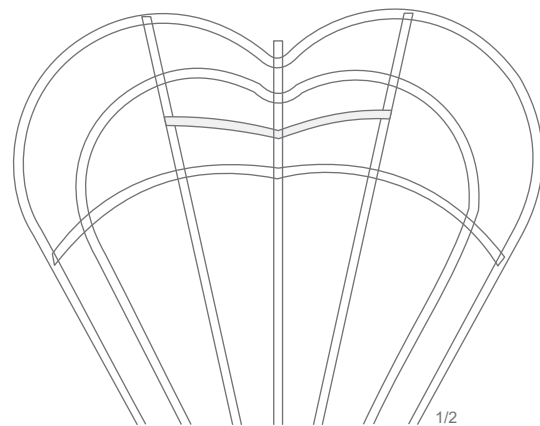

Cardiovascular Clamps
 Kardiovaskuläre Klemmen
 Pinzas cardiovasculares
 Pinces cardiovasculaires
 Pinze cardiovascolari



28-201-22
Price-Thomas Bronchus Clamp
 Overall Length 22 cm (8 3/4")



Price-Thomas Bronchus Clamp
 Overall Length 22 cm (8 3/4")

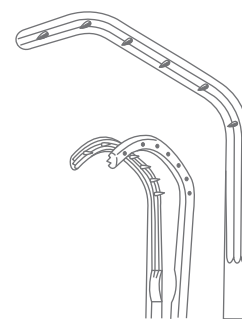

28-205-22
 Fig. 1, Spikes on Left Jaw

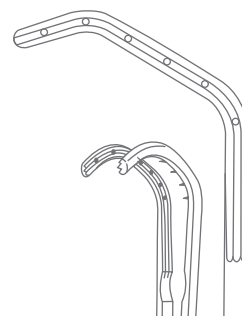

28-207-22
 Fig. 2, Spikes on Right Jaw

Cardiovascular Clamps
Kardiovaskuläre Klemmen
Pinzas cardiovasculares
Pinces cardiovasculaires
Pinze cardiovascolari

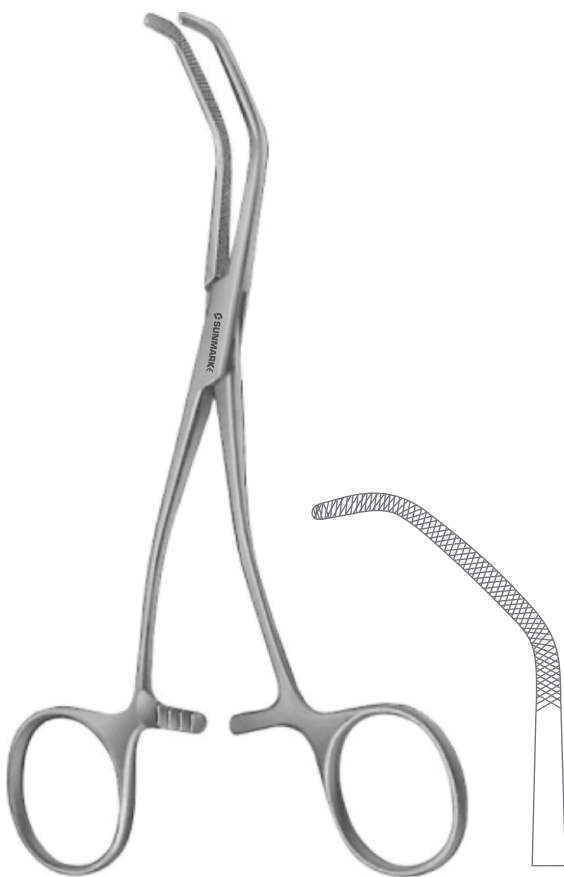

28-209-15
Baby-Satinsky Anastomosis Clamp
Cross Serrated
Overall Length 15 cm (6")



28-211-26
Baby-Satinsky Anastomosis Clamp
Cross Serrated
Overall Length 26.5 cm (10 1/2")

Cardiovascular Clamps
Kardiovaskuläre Klemmen
Pinzas cardiovasculares
Pincers cardiovasculaires
Pinze cardiovascolari



Baby-Satinsky Anastomosis Clamp
Overall Length 26.5 cm (10 1/2")

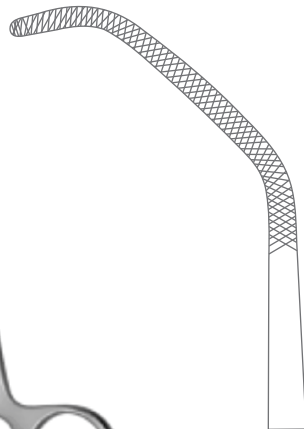

28-213-01
Cross Serrated
Fig. 1

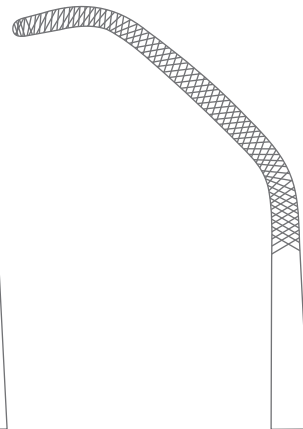

28-213-02
Cross Serrated
Fig. 2

Cardiovascular Clamps
Kardiovaskuläre Klemmen
Pinzas cardiovasculares
Pinces cardiovasculaires
Pinze cardiovascolari



Semb Bronchus Clamp



28-215-24
Slightly Curved
24.5 cm (9 3/4")



28-217-24
Strongly Curved
24 cm (9 1/2")

Lung Grasping Forceps
Lungenfasszangen
Pinzas para coger el pulmón
Pince-clamps à poumons
Pinze per afferrare polmone



28-220-20
Lovelace Lung Grasping Forcep
Overall Length 20.5 cm (8")

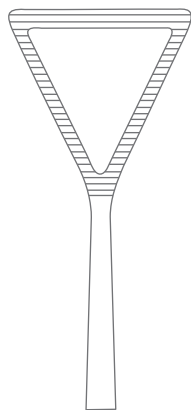

28-221-20
Lovelace Lung Grasping Forcep
Laterally Curved
Overall Length 20.5 cm (8")

Bulldog Clamps
 Bulldogklemmen
 Clamps Bulldog
 Clamps Bulldog
 Pinze Bulldog

Atrauma™

DeBakey Atrauma Bulldog Clamp
 Straight

	Jaw Size
28-250-07	25 mm
28-250-08	35 mm
28-250-10	50 mm
28-250-12	68 mm

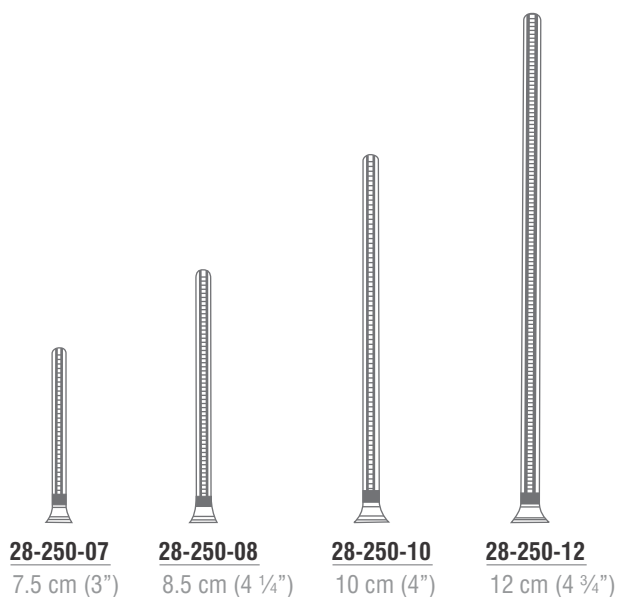

Atrauma™

DeBakey Atrauma Bulldog Clamp
 Curved

	Jaw Size
28-251-07	23 mm
28-251-08	31 mm
28-251-10	42 mm
28-251-12	58 mm

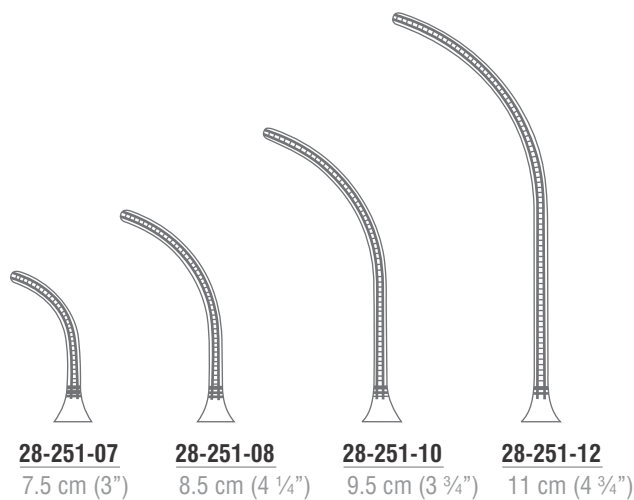

Bulldog Clamps
Bulldogklemmen
Clamps Bulldog
Clamps Bulldog
Pinze Bulldog



28-253-23

Bulldog Clamp Applying Forcep

Overall Length 23.5 cm (9 1/4")



Bulldog Clamps
 Bulldogklemmen
 Clamps Bulldog
 Clamps Bulldog
 Pinze Bulldog

Atrauma™

Glover Atrauma Bulldog Clamp
 Straight

	Jaw Size
28-260-06	32 mm
28-260-07	37 mm
28-260-09	50 mm
28-260-11	69 mm

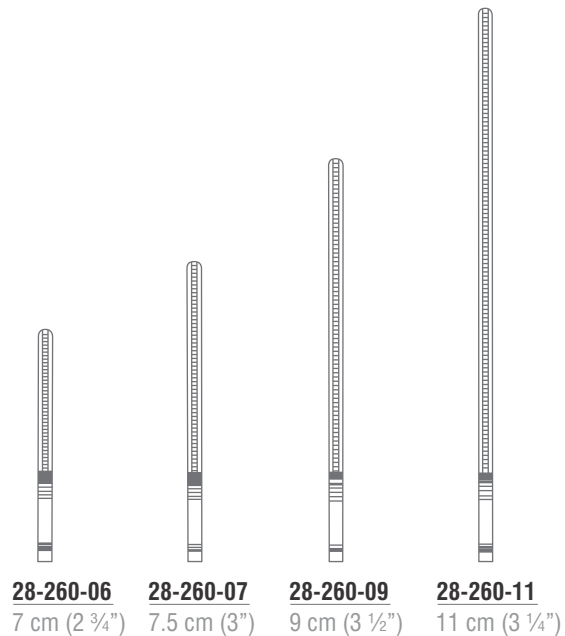

THORAX, CARDIOVASCULAR SURGERY

Atrauma™

Glover Atrauma Bulldog Clamp
 Curved

	Jaw Size
28-261-06	33 mm
28-261-07	37 mm
28-261-09	50 mm
28-261-11	69 mm

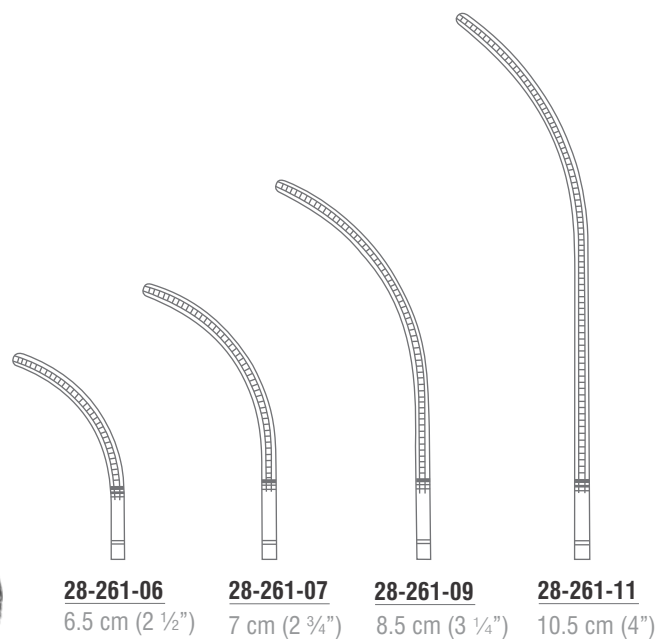

Bulldog Clamps
Bulldogklemmen
Clamps Bulldog
Clamps Bulldog
Pinze Bulldog



Atrauma™



28-265-07
DeBakey-Satinsky Atrauma Bulldog Clamp
38 mm
Overall Length 7 cm (2 ¾")



28-265-09
DeBakey-Satinsky Atrauma Bulldog Clamp
54 mm
Overall Length 9 cm (3 ½")



28-265-10
DeBakey-Satinsky Atrauma Bulldog Clamp
63 mm
Overall Length 10 cm (4")



28-277-06
Glover Atrauma Bulldog Clamp
35 mm
Overall Length 6 cm (2 ¼")



28-281-07
Santulli Atrauma Bulldog Clamp
Overall Length 7 cm (2 ¾")

Bulldog Clamps
 Bulldogklemmen
 Clamps Bulldog
 Clamps Bulldog
 Pinze Bulldog

Atrauma™

Gregory-Soft Atrauma Bulldog Clamp
 Carotid Clamp

	Jaw Size
28-285-09	45 mm
28-285-11	58 mm

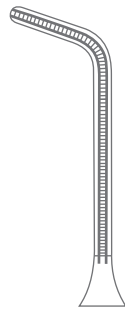

28-285-09
 9 cm (3 1/2")

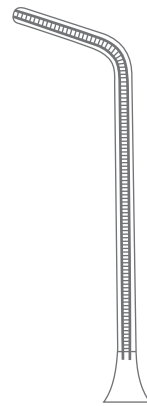

28-285-11
 11 cm (3 1/4")

Atrauma™

Gregory Atrauma Bulldog Clamp
 Carotid Clamp

	Jaw Size	Profile
28-287-01	62 mm	Left
28-287-02	62 mm	Right

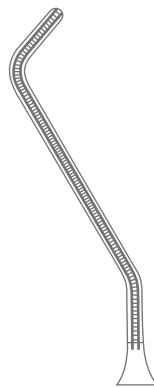

28-287-01
 10.5 cm (3 1/2")

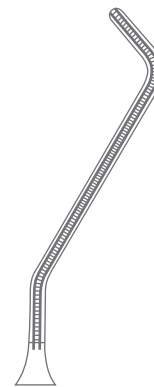

28-287-02
 10.5 cm (3 1/2")

THORAX, CARDIOVASCULAR SURGERY

Bulldog Clamps
Bulldogklemmen
Clamps Bulldog
Clamps Bulldog
Pinze Bulldog



28-289-10
George-Krasopoulos Atrauma Bulldog Artery Clamp
Overall Length 10.5 cm (4")

28-293-25
Mueller Atrauma Bulldog Clamp
Angled, 91 mm, (250 Grams)

28-295-25
Mueller Atrauma Bulldog Clamp
Slightly Curved, 112 mm, (250 Grams)

28-293-35
Mueller Atrauma Bulldog Clamp
Angled, 91 mm, (350 Grams)

28-295-35
Mueller Atrauma Bulldog Clamp
Slightly Curved, 112 mm, (350 Grams)

28-297-25
Mueller Atrauma Bulldog Clamp
Curved, 112 mm, (250 Grams)

28-299-25
Mueller Atrauma Bulldog Clamp
Knee Bent, 108 mm, (250 Grams)

28-297-35
Mueller Atrauma Bulldog Clamp
Curved, 112 mm, (350 Grams)

28-299-35
Mueller Atrauma Bulldog Clamp
Knee Bent, 108 mm, (350 Grams)



Cardiovascular Clamps
Kardiovaskuläre Klemmen
Pinzas cardiovasculares
Pinces cardiovasculaires
Pinze cardiovascolari

THORAX, CARDIOVASCULAR SURGERY

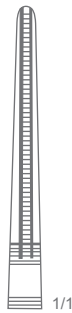

28-300-16
Straight, 40 mm

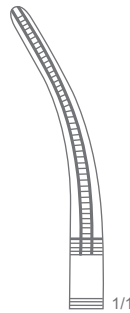

28-301-16
Curved, 40 mm



DeBakey-Rankin Atrauma Hemostatic Forcep
Overall Length 16 cm (6 1/4")

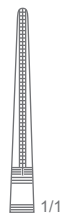
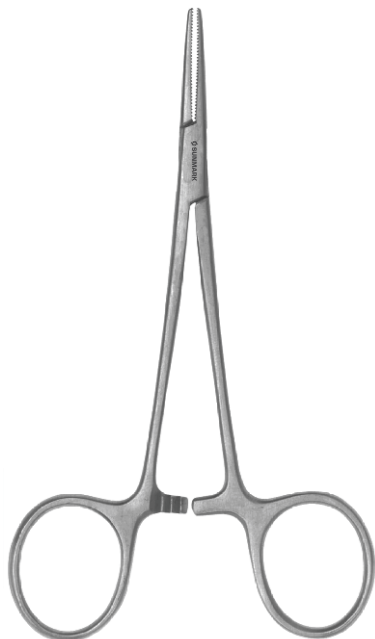

28-304-15
Straight, 27 mm

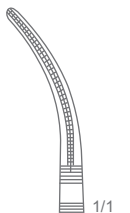

28-305-15
Curved, 27 mm



DeBakey-Mosquito Atrauma Hemostatic Forcep
Overall Length 15 cm (6")

Cardiovascular Clamps
Kardiovaskuläre Klemmen
Pinzas cardiovasculares
Pinces cardiovasculaires
Pinze cardiovascolari



28-307-01
Slightly Curved
81 mm
25 cm (10")

DeBakey-Rumel Atrauma Dissecting & Ligature Forcep

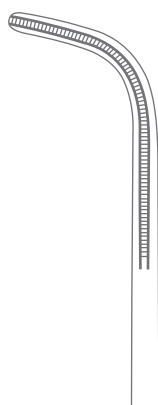
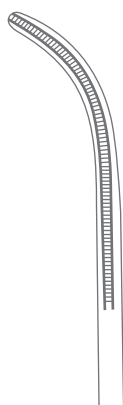

28-307-02
Strongly Curved
81 mm
24.5 cm (9 3/4")



28-309-28
DeBakey-Mixer Atrauma Dissecting & Ligature Forcep
80 mm
Overall Length 28.5 cm (11 1/4")



Cardiovascular Clamps
Kardiovaskuläre Klemmen
Pinzas cardiovasculares
Pincés cardiovasculaires
Pinze cardiovascolari

Atrauma™

THORAX, CARDIOVASCULAR SURGERY



28-311-21
DeBakey-McQuigg-Mixer Atrauma Dissecting & Ligature Forcep
70 mm
Overall Length 21 cm (8 1/4")



28-313-24
Purse String Forcep
55 mm Wide Jaws
Overall Length 24 cm (9 3/4")

Cardiovascular Clamps
Kardiovaskuläre Klemmen
Pinzas cardiovasculares
Pincès cardiovasculaires
Pinze cardiovascolari



28-315-23
Ochsner Atrauma Aortic Clamp
50 mm
Overall Length 23.5 cm (9 1/4")

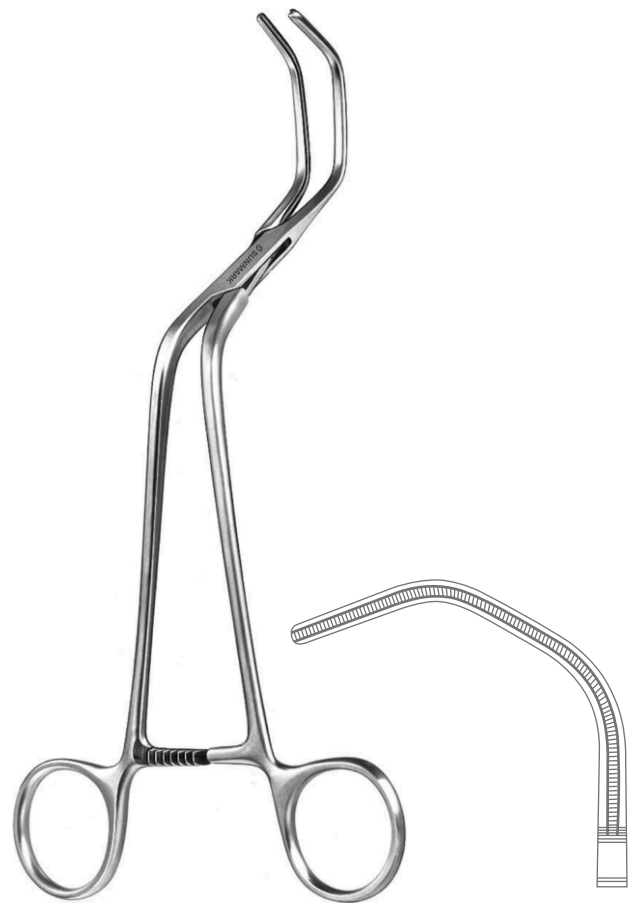

28-317-22
Diethrich Atrauma Aortic Clamp
45 mm
Overall Length 22 cm (8 3/4")



Cardiovascular Clamps
Kardiovaskuläre Klemmen
Pinzas cardiovasculares
Pincas cardiovasculaires
Pinze cardiovascolari

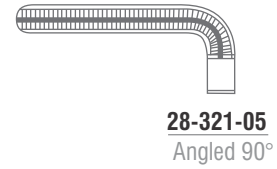
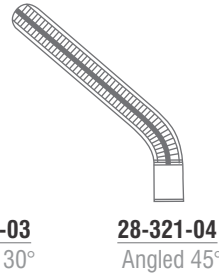
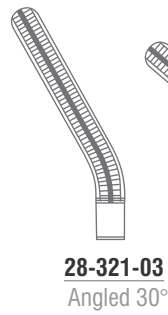
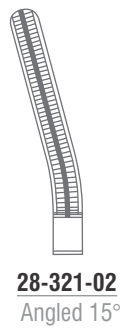
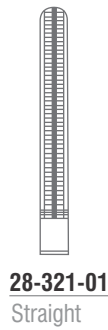

Dardik Atrauma Multipurpose Vascular Clamp
30 mm
Overall Length 15 cm (6")

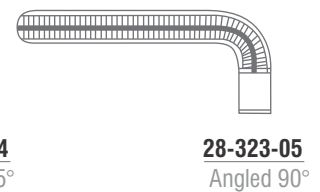
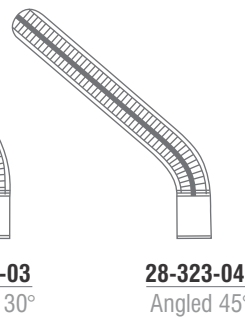
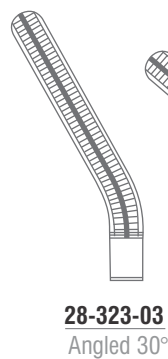
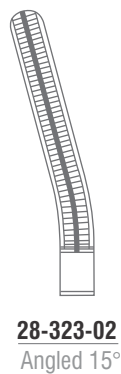
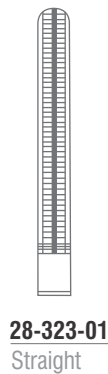

Dardik Atrauma Multipurpose Vascular Clamp
50 mm
Overall Length 17 cm (6 3/4")

THORAX, CARDIOVASCULAR SURGERY

Cardiovascular Clamps
Kardiovaskuläre Klemmen
Pinzas cardiovasculares
Pinces cardiovasculaires
Pinze cardiovascolari



28-331-18
Dale Atrauma Peripheral Vascular Clamp
37 mm
Overall Length 18 cm (7")

Atrauma™

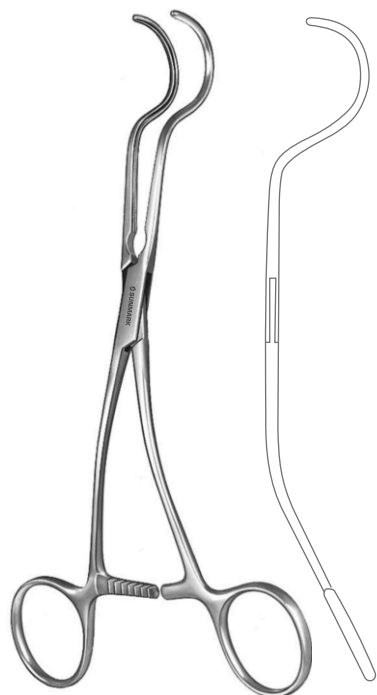

28-333-17
20 mm
17.5 cm (7")

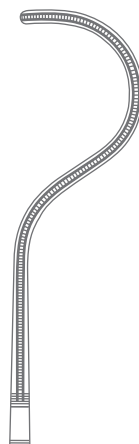

28-333-18
25 mm
18 cm (7")

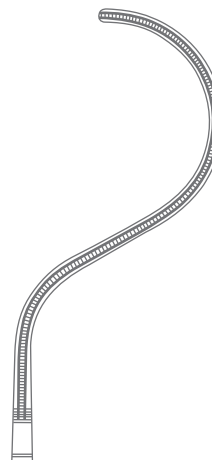

28-333-19
35 mm
18.5 cm (7 1/4")

Dale Atrauma Peripheral Vascular Clamp

Atrauma™

Cardiovascular Clamps
Kardiovaskuläre Klemmen
Pinzas cardiovasculares
Pinces cardiovasculaires
Pinze cardiovascolari



28-335-18
Klintman Liver Transplant Clamp
Overall Length 18 cm (7")

THORAX, CARDIOVASCULAR SURGERY



Gregory Atrauma Profunda Clamp

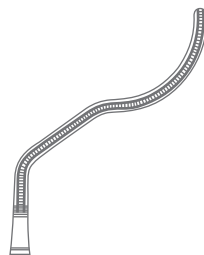

28-337-14
13 cm (5")
45 mm

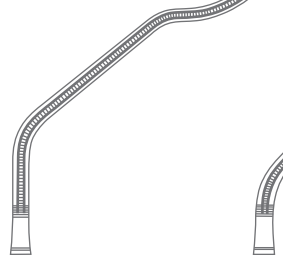

28-337-16
16 cm (6 1/4")
70 mm

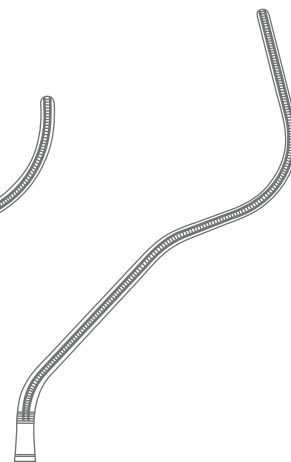

28-337-18
18 cm (7")
78 mm



Cardiovascular Clamps
Kardiovaskuläre Klemmen
Pinzas cardiovasculares
Pinces cardiovasculaires
Pinze cardiovascolari



28-341-18
Javid Carotid Shunt Clamp
Overall Length 17.5 cm (7")



28-341-19
Javid Carotid Shunt Clamp
Overall Length 18 cm (7")



Cooley Catheter Clamp

- 28-343-24** 16 cm (6 1/4"), Ø 24 Charr.
- 28-343-26** 16 cm (6 1/4"), Ø 26 Charr.
- 28-343-28** 20 cm (8"), Ø 28 Charr.
- 28-343-30** 20 cm (8"), Ø 30 Charr.
- 28-343-32** 20 cm (8"), Ø 32 Charr.
- 28-343-36** 20 cm (8"), Ø 36 Charr.

Cardiovascular Clamps
Kardiovaskuläre Klemmen
Pinzas cardiovasculares
Pincas cardiovasculaires
Pinze cardiovascolari

Atrauma™

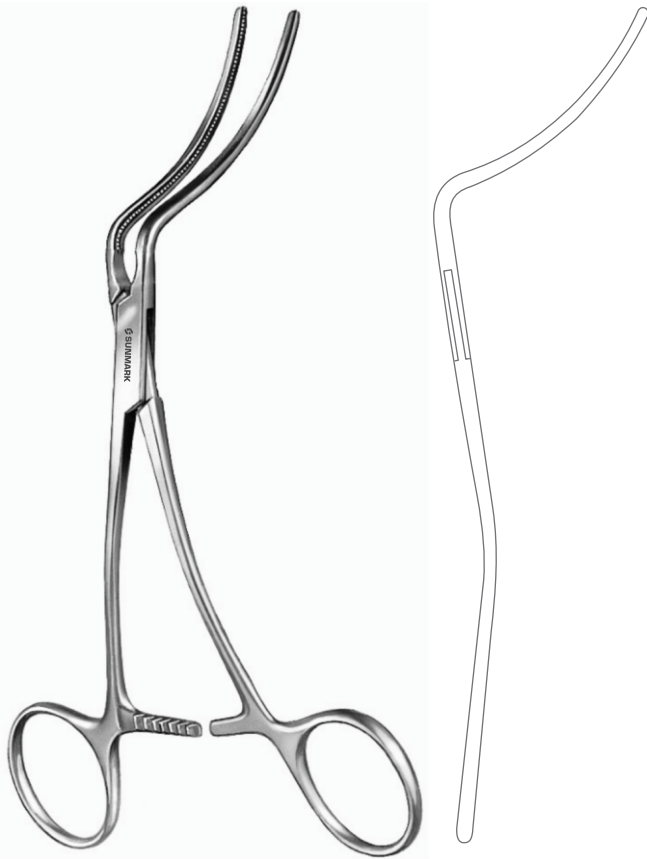

DeBakey-Wylie Atrauma Peripheral Vascular Clamp

**Discuss Omar sir
Sizes Issue KLS Martin**

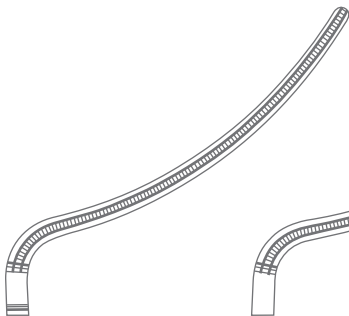

28-345-01
55 mm
16 cm (6 ¼")

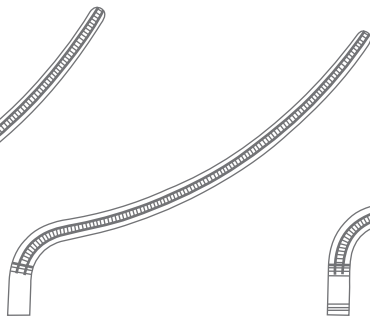

28-345-02
55 mm
16.5 cm (6 ½")

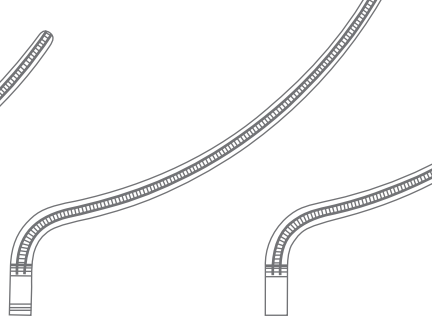

28-345-03
80 mm
18 cm (7")

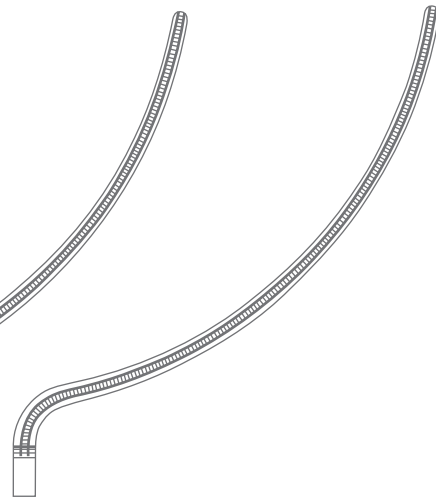

28-345-04
80 mm
19.5 cm (7 ¾")

Cardiovascular Clamps
Kardiovaskuläre Klemmen
Pinzas cardiovasculares
Pinces cardiovasculaires
Pinze cardiovascolari

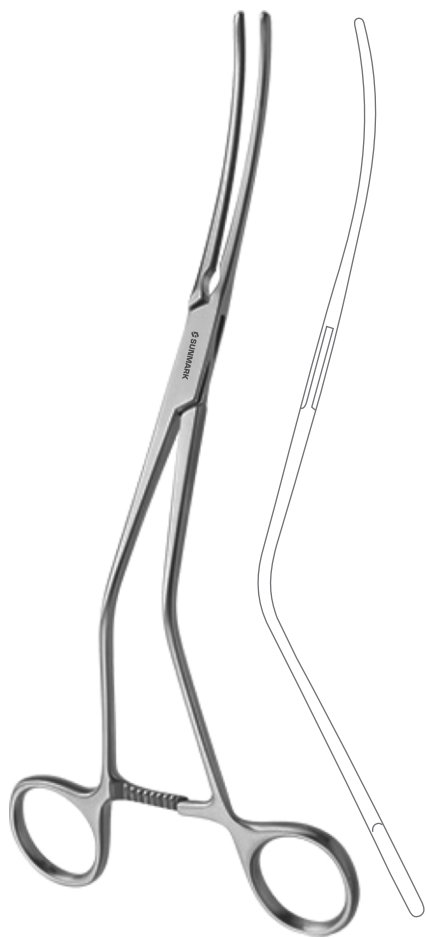

Wylie Atrauma Aortic Clamp

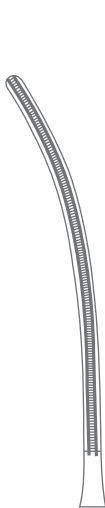

28-347-24
24 cm (9 1/2")

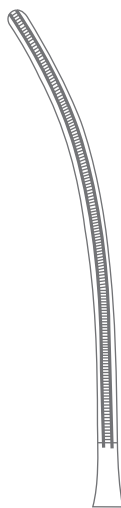

28-347-27
27 cm (10 1/2")



28-349-30
DeBakey Atrauma Aortic Clamp
115 mm
Overall Length 30 cm (11 3/4")



Cardiovascular Clamps
Kardiovaskuläre Klemmen
Pinzas cardiovasculares
Pincas cardiovasculaires
Pinze cardiovascolari

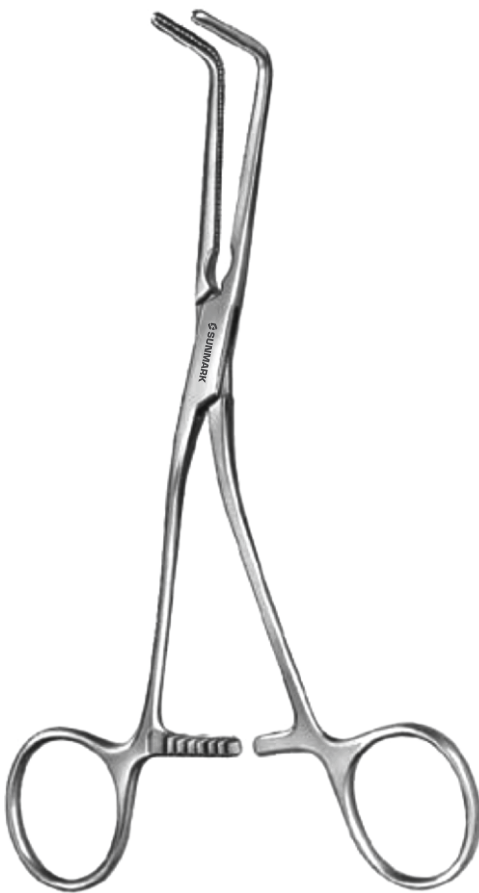

Husfeldt Atrauma Peripheral Vascular Clamp

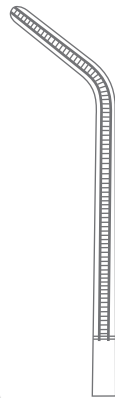

28-351-18
48 mm
17,5 cm (7")

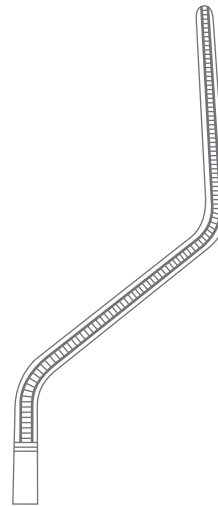

28-353-18
30 mm x 30 mm
18 cm (7")



28-355-17
28 mm
17 cm (6 3/4")

Atrauma™

Cardiovascular Clamps
 Kardiovaskuläre Klemmen
 Pinzas cardiovasculares
 Pincas cardiovasculaires
 Pinze cardiovascolari



Potts Atrauma Coarctation Clamp

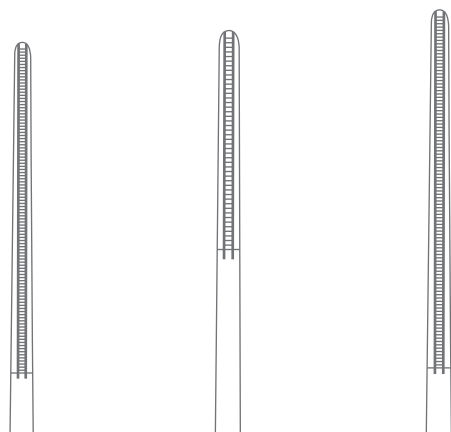

28-370-20

Straight
 41 mm
 20.5 cm (8")

28-370-21

Straight
 30 mm
 21 cm (8 1/4")

28-370-22

Straight
 55 mm
 22.5 cm (8 3/4")

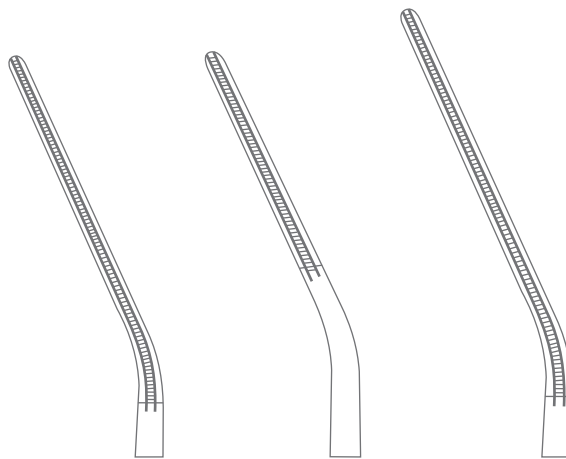

28-371-20

Angled 15°
 41 mm
 20.5 cm (8")

28-371-21

Angled 15°
 30 mm
 20.5 cm (8")

28-371-22

Angled 15°
 55 mm
 22.5 cm (8 3/4")

Cardiovascular Clamps
Kardiovaskuläre Klemmen
Pinzas cardiovasculares
Pincés cardiovasculaires
Pinze cardiovascolari

THORAX, CARDIOVASCULAR SURGERY



Potts Atrauma Coarctation Clamp

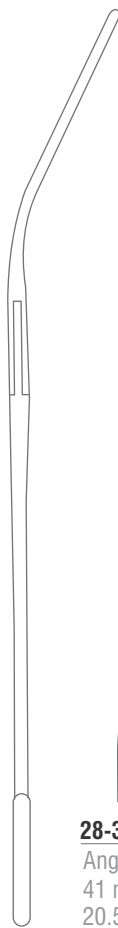

28-373-20
Angled 15°
41 mm
20.5 cm (8")

28-373-21
Angled 15°
30 mm
20.5 cm (8")

28-373-22
Angled 15°
55 mm
22 cm (8")



Cardiovascular Clamps
Kardiovaskuläre Klemmen
Pinzas cardiovasculares
Pinces cardiovasculaires
Pinze cardiovascolari



Potts Atrauma Anastomosis Clamp



28-375-22
Curved, 65 mm
21.5 cm (8 1/2")



28-377-22
Curved, 60 mm
22 cm (8 3/4")



DeBaey Atrauma Dissecting and Ligature Forcep

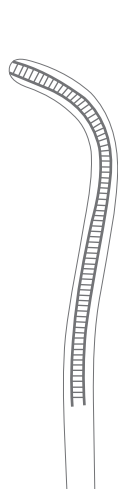

28-379-21
51 mm
21 cm (8 1/4")

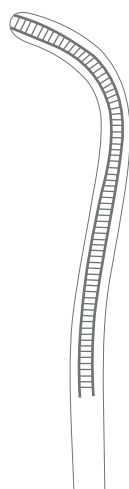

28-379-23
51 mm
23 cm (9")



Cardiovascular Clamps
 Kardiovaskuläre Klemmen
 Pinzas cardiovasculares
 Pinces cardiovasculaires
 Pinze cardiovascolari



28-381-19
 77 mm
 19 cm (7 1/2")

28-381-23
 180 mm
 24 cm (9 1/2")



DeBakey Atrauma Dissecting and Ligature Forcep



28-383-16
 56 mm
 16 cm (6 1/4")

28-385-19
 90 mm
 19 cm (7 1/2")

28-385-20
 92 mm
 19.5 cm (7 3/4")

DeBakey Atrauma Peripheral Vascular Clamp

THORAX, CARDIOVASCULAR SURGERY

Cardiovascular Clamps
Kardiovaskuläre Klemmen
Pinzas cardiovasculares
Pincas cardiovasculaires
Pinze cardiovascolari

Atrauma™

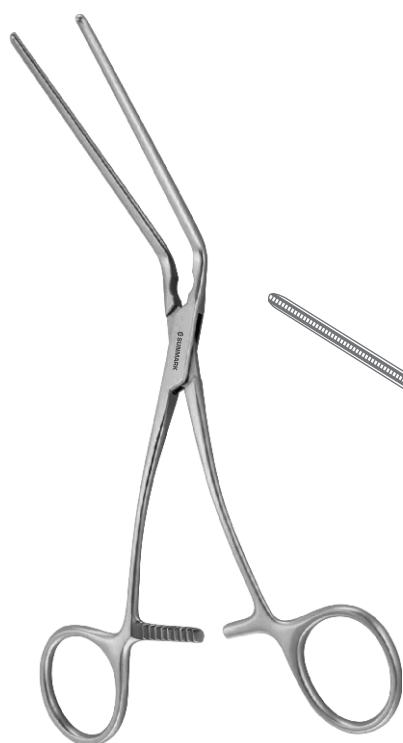

Leland-Jones Atrauma Peripheral Vascular Clamp



28-387-18
Angled 60°
77 mm
18 cm (7")

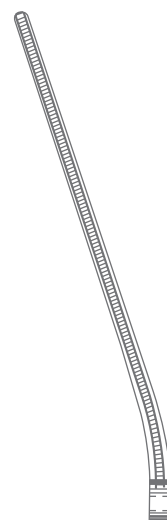

28-387-19
Angled 30°
77 mm
18.5 cm (7 1/4")

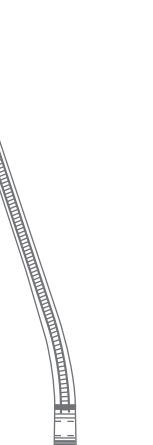

28-387-20
Angled 30°
77 mm
19.5 cm (7 3/4")



28-388-20
Straight
77 mm
19.5 cm (7 3/4")



Cardiovascular Clamps
Kardiovaskuläre Klemmen
Pinzas cardiovasculares
Pinces cardiovasculaires
Pinze cardiovascolari

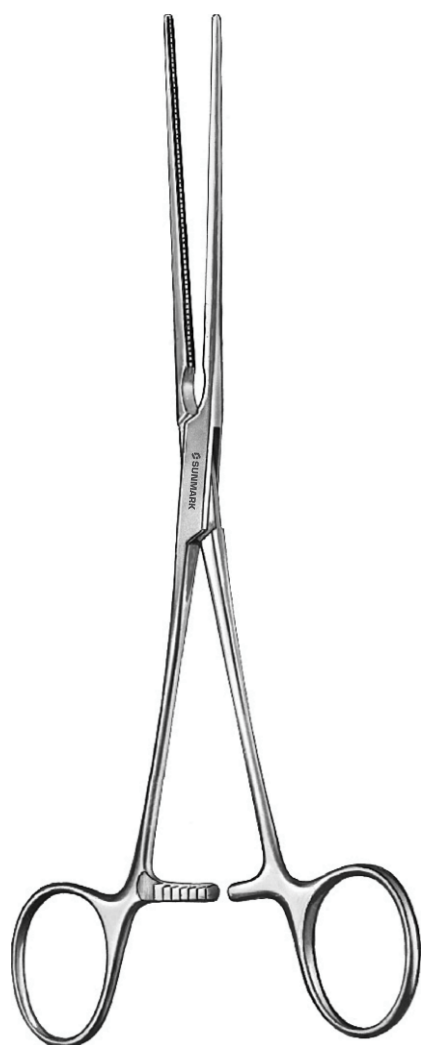

28-390-15
Straight
40 mm
15 cm (6")

28-390-18
Straight
65 mm
18.5 cm (7 1/4")

28-391-15
Curved
40 mm
15 cm (6")

28-391-18
Curved
65 mm
18.5 cm (7 1/4")

Bainbridge Atrauma Multipurpose Vascular Clamp



Cardiovascular Clamps
Kardiovaskuläre Klemmen
Pinzas cardiovasculares
Pinces cardiovasculaires
Pinze cardiovascolari

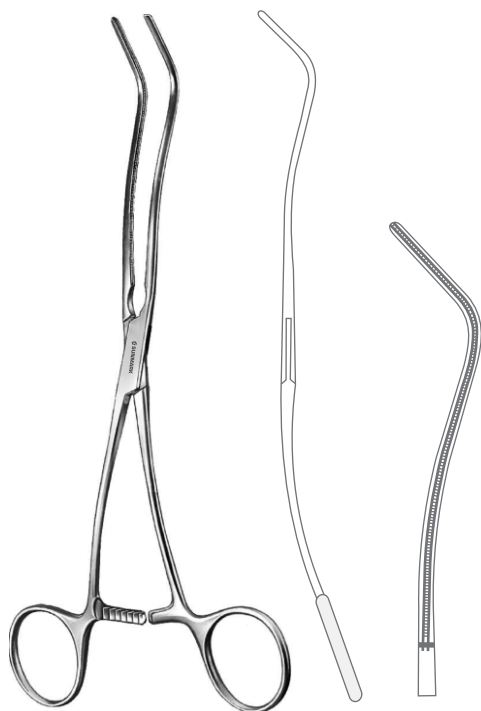

Atrauma™

28-393-20
DeBakey Atrauma Multipurpose Vascular Clamp
180 mm
Overall Length 20 cm (8")

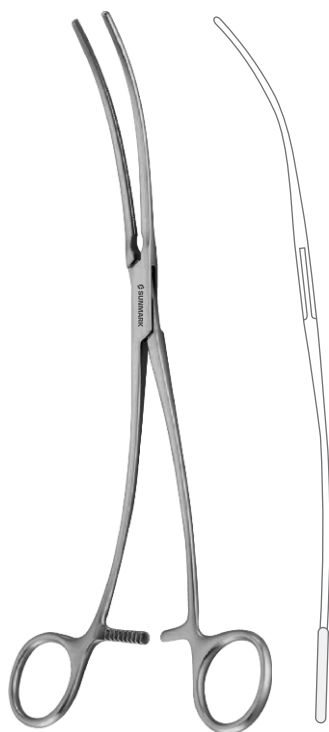

28-395-26
95 mm
26 cm (10 1/4")

28-395-27
110 mm
27 cm (10 3/4")

28-395-31
130 mm
31 cm (12 1/4")

28-395-33
140 mm
33 cm (13")

28-397-28
90 mm
28 cm (11")

DeBakey Atrauma Aortic Aneurysm Clamp

Cardiovascular Clamps
Kardiovaskuläre Klemmen
Pinzas cardiovasculares
Pincas cardiovasculaires
Pinze cardiovascolari



28-399-30
DeBakey Atrauma Aortic Aneurysm Clamp
115 mm
Overall Length 30 cm (11 3/4")

Atrauma™



28-401-27
DeBakey Atrauma Aortic Clamp
Angled 70°, 60 mm
Overall Length 27 cm (10 3/4")

Atrauma™

Cardiovascular Clamps
Kardiovaskuläre Klemmen
Pinzas cardiovasculares
Pinces cardiovasculaires
Pinze cardiovascolari



28-403-24
DeBakey Atrauma Ligature Forcep 24.5 cm - 9 3/4"



28-405-24
DeBakey Atrauma Ligature Forcep 24.5 cm - 9 3/4"



Rib Retractors
Rippensperrer
Separadores costales
Ecarteurs des côtes
Divaricatori costali

28

THORAX, CARDIOVASCULAR SURGERY

28-407-25

DeBakey Atrauma Ligature Forcep 24.5 cm - 9 3/4"

 atrauma™



Cardiovascular Clamps
Kardiovaskuläre Klemmen
Pinzas cardiovasculares
Pinces cardiovasculaires
Pinze cardiovascolari

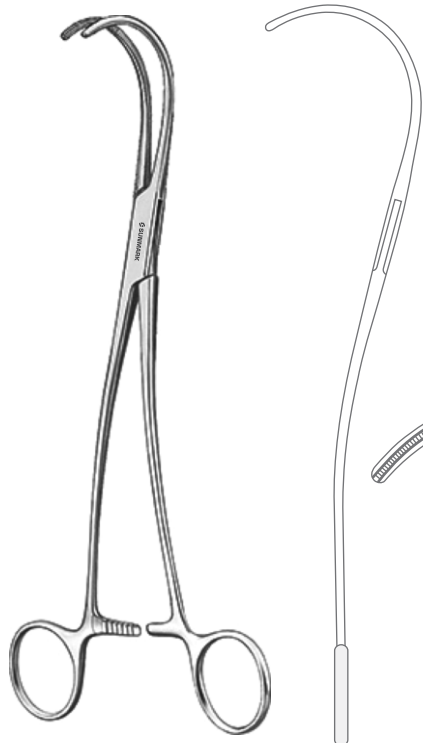

28-409-26
DeBakey Atrauma Aortic Clamp
60 mm
Overall Length 27 cm (10 3/4")

Atrauma™



Weber Atrauma Aortic Clamp
52 mm
Overall Length 24 cm (9 1/2")

28-411-01
Right

28-411-02
Left

Cardiovascular Clamps
Kardiovaskuläre Klemmen
Pinzas cardiovasculares
Pincas cardiovasculaires
Pinze cardiovascolari

Atrauma™

THORAX, CARDIOVASCULAR SURGERY

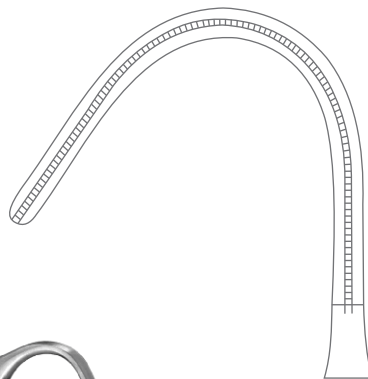

28-413-01
25 mm
22.5 cm (8 ¾")

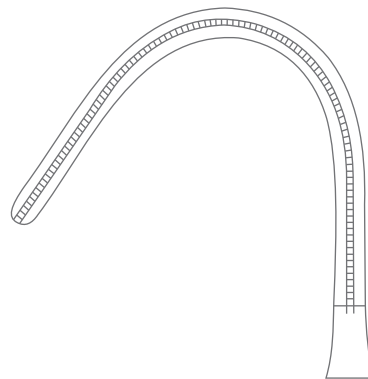

28-413-02
25 mm
23 cm (9")

Wylie Atrauma Aortic Aneurysm Clamp

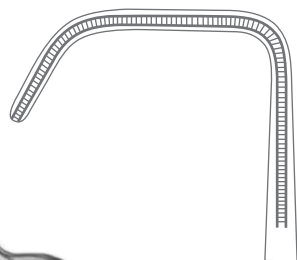

28-415-01
41 mm

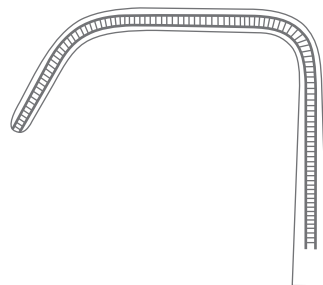

28-415-02
51 mm

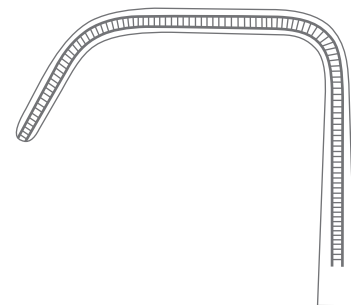

28-415-02
65 mm

Hopt Atrauma Clamp
Kidney & Pancreas Clamp
Overall Length 20 cm (8")

Cardiovascular Clamps
Kardiovaskuläre Klemmen
Pinzas cardiovasculares
Pinces cardiovasculaires
Pinze cardiovascolari



Satinsky Atrauma Tangential Occlusion Clamp

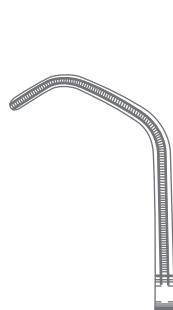

28-417-20
38 mm
22 cm (8 3/4")

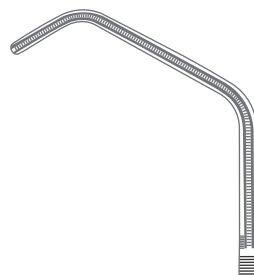

28-417-24
48 mm
26 cm (10 1/4")

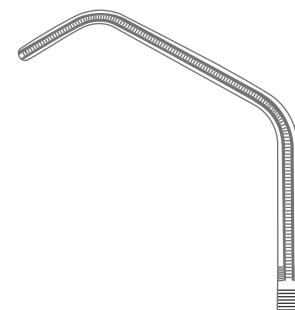

28-417-25
54 mm
26.5 cm (10 1/2")

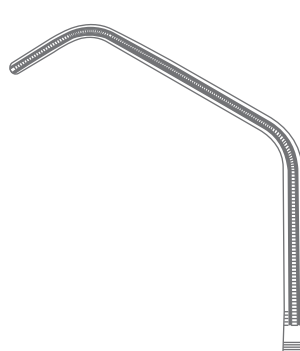

28-417-26
58 mm
27.5 cm (10 1/2")



28-417-27
75 mm
27.5 cm (10 1/2")

Cardiovascular Clamps
Kardiovaskuläre Klemmen
Pinzas cardiovasculares
Pincas cardiovasculaires
Pinze cardiovascolari

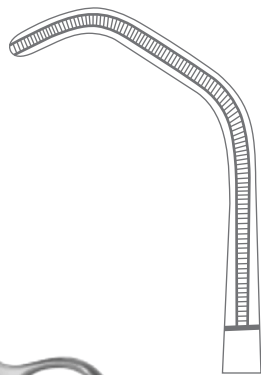

28-419-23
32 mm
23.5 cm (9 1/4")

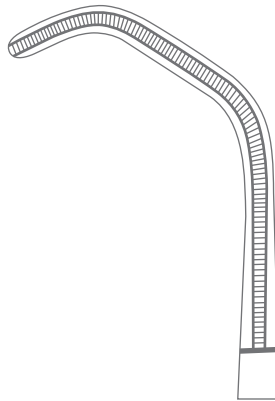

28-419-24
40 mm
24 cm (9 1/2")

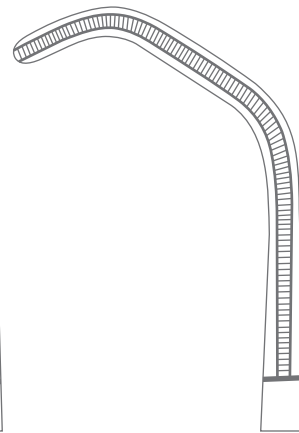

28-419-25
47 mm
24.5 cm (9 1/2")

DeBakey Satinsky Atrauma Tangential Occlusion Clamp

Atrauma™

Cardiovascular Clamps
Kardiovaskuläre Klemmen
Pinzas cardiovasculares
Pinces cardiovasculaires
Pinze cardiovascolari



Harken Atrauma Auricle Clamp

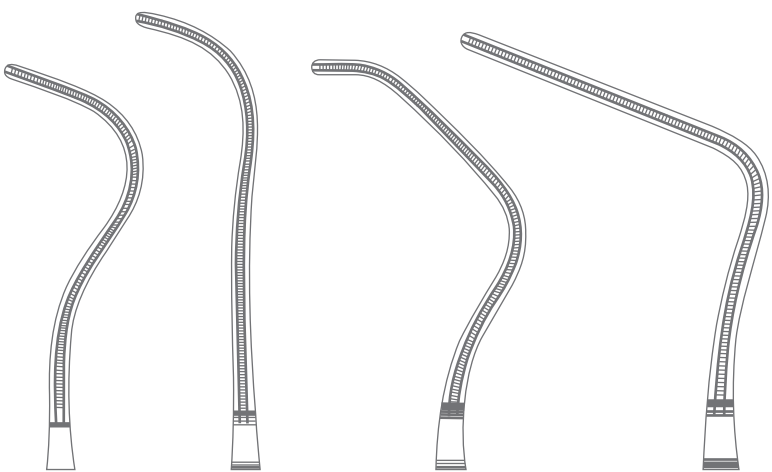

28-421-01
86 mm
25.5 cm (10")

28-421-02
86 mm
24 cm (9 1/2")

28-421-03
86 mm
24.5 cm (9 3/4")

28-421-04
86 mm
23.5 cm (9 1/4")

Cardiovascular Clamps
Kardiovaskuläre Klemmen
Pinzas cardiovasculares
Pinces cardiovasculaires
Pinze cardiovascolari

Atrauma™

THORAX, CARDIOVASCULAR SURGERY



Lees Atrauma Bronchus Clamp

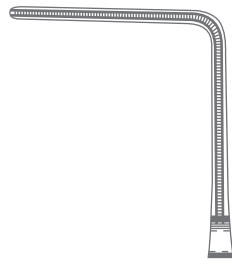

28-423-23
Angled 90°
42 mm
23 cm (9")

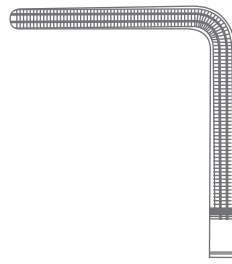

28-423-25
Angled 90°
42 mm
2 x 3 DeBakey Teeth
25.5 cm (10")



Lees Atrauma Bronchus Clamp

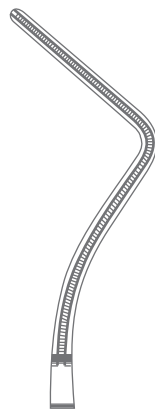

28-425-25
95 mm
25 cm (9 3/4")

Cardiovascular Clamps
Kardiovaskuläre Klemmen
Pinzas cardiovasculares
Pinces cardiovasculaires
Pinze cardiovascolari

Atrauma™



Lambert-Kay Atrauma Anastomosis Clamp

Overall Length 22.5 cm (8 3/4")

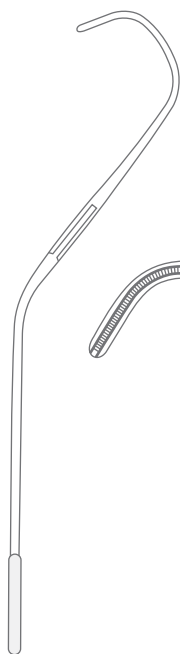

28-427-21
40 mm

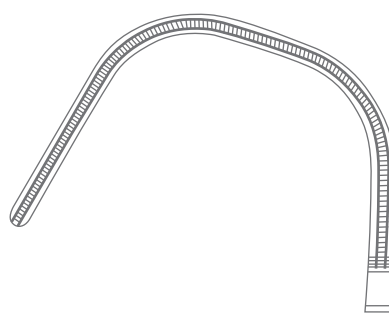
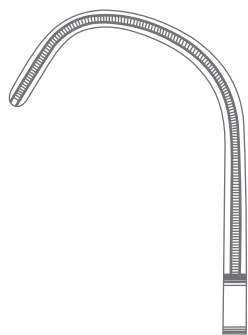

28-427-22
47 mm



28-429-17

Lambert-Kay Atrauma Anastomosis Clamp

24 mm

Overall Length 16.5 cm (6 1/2")

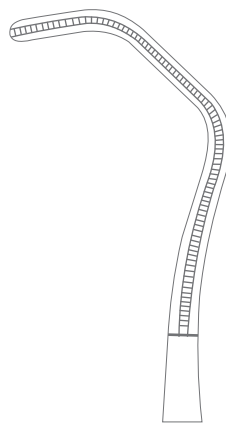
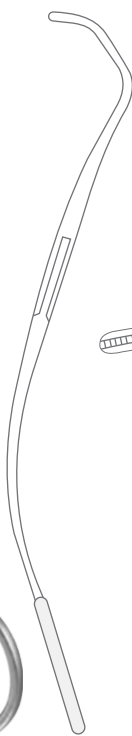

Cardiovascular Clamps
Kardiovaskuläre Klemmen
Pinzas cardiovasculares
Pincas cardiovasculaires
Pinze cardiovascolari

Atrauma™



Morris-DeBakey Atrauma Aortic Clamp

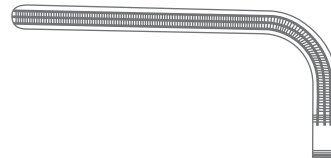

28-431-01
Angled 90°
67 mm
16.5 cm (6 1/2")

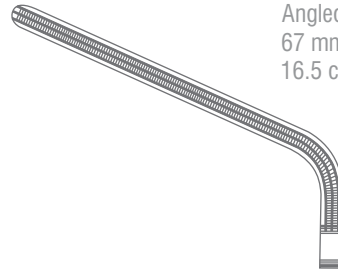

28-431-02
Angled 70°
67 mm
20 cm (8")

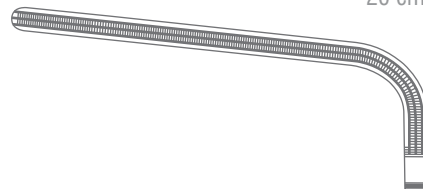

28-431-03
Angled 70°
70 mm
24 cm (9 1/2")



28-431-04
Angled 90°
70 mm
26 cm (10 1/4")

Cardiovascular Clamps
Kardiovaskuläre Klemmen
Pinzas cardiovasculares
Pinces cardiovasculaires
Pinze cardiovascolari



DeBakey-Bahnson Atrauma Aneurysm Clamp

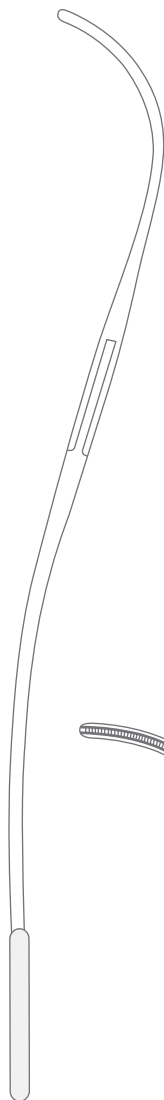

28-433-23
70 mm
25.5 cm (10")

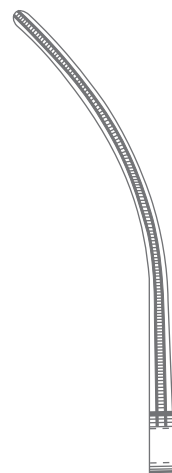

28-433-24
75 mm
26.5 cm (10 1/2")

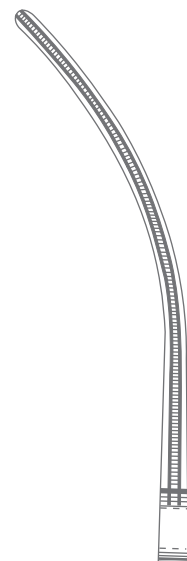

28-433-25
85 mm
28 cm (11")



Cardiovascular Clamps
 Kardiovaskuläre Klemmen
 Pinzas cardiovasculares
 Pincas cardiovasculaires
 Pinze cardiovascolari

Atrauma™



Potts Atrauma Multipurpose Vascular Clamp

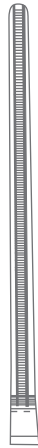

28-436-21
 Straight
 60 mm
 21.5 cm (8 ½")

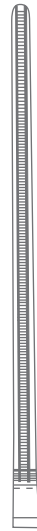

28-436-23
 Straight
 75 mm
 23.5 cm (9")

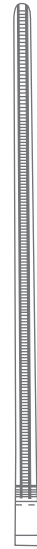

28-436-27
 Straight
 82 mm
 27 cm (10 ¾")

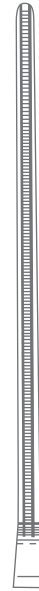

28-436-31
 Straight
 100 mm
 31 cm (12 ¼")

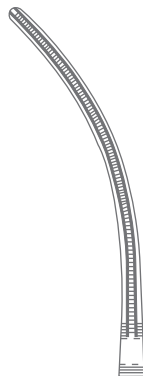

28-437-21
 Curved
 60 mm
 21 cm (8 ¼")

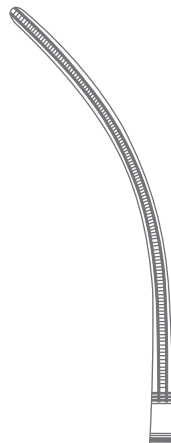

28-437-23
 Curved
 75 mm
 23 cm (9")

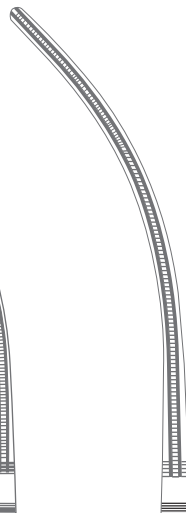

28-437-27
 Curved
 82 mm
 26 cm (10 ¼")

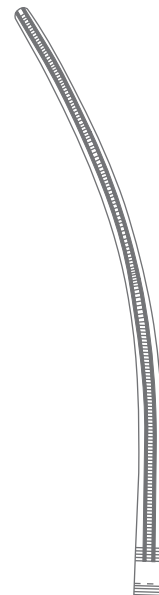

28-437-31
 Curved
 100 mm
 30.5 cm (12")

Cardiovascular Clamps
Kardiovaskuläre Klemmen
Pinzas cardiovasculares
Pinces cardiovasculaires
Pinze cardiovascolari

Atrauma™



DeBakey Atrauma Multipurpose Vascular Clamp



28-439-18
Angled 90°
50 mm
18 cm (7")

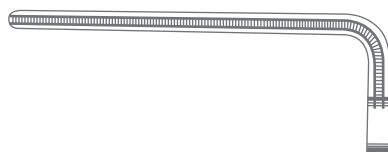

28-439-19
Angled 90°
69 mm
18.5 cm (7 1/4")

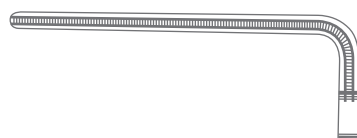

28-439-23
Angled 90°
87 mm
21.5 cm (8 1/2")



28-439-27
Angled 90°
108 mm
25.5 cm (10")

Rib Retractors
Rippensperrer
Separadores costales
Ecarteurs des côtes
Divaricatori costali

28

THORAX, CARDIOVASCULAR SURGERY

28-440-25

DeBakey Atrauma Multipurpose Vascular Clamp

Angled 45°

Overall Length 26 cm (10 1/4")

 **Atrauma™**



Rib Retractors
Rippensperrer
Separadores costales
Ecarteurs des côtes
Divaricatori costali



DeBakey Atrauma Multipurpose Vascular Clamp

Atrauma™



28-441-20
Angled 60°
50 mm
21 cm (8 1/4")

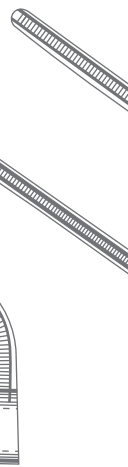

28-441-21
Angled 60°
70 mm
22 cm (8 3/4")

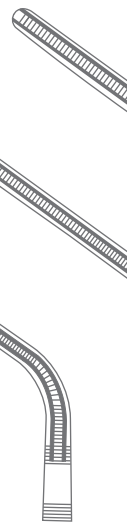

28-441-25
Angled 60°
82 mm
26 cm (10 1/4")

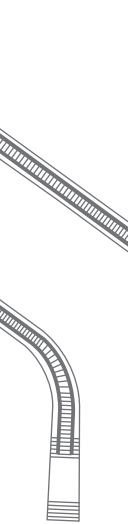

28-441-29
Angled 60°
105 mm
31 cm (12 1/4")

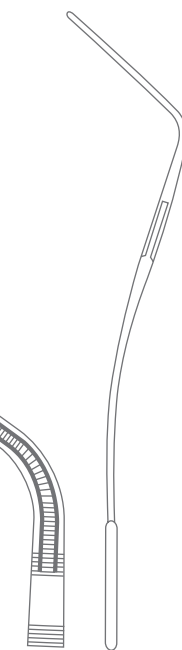

Cardiovascular Clamps
Kardiovaskuläre Klemmen
Pinzas cardiovasculares
Pinces cardiovasculaires
Pinze cardiovascolari

Atrauma™

28-443-25

DeBakey Atrauma Multipurpose Vascular Clamp

Angled 45°

Overall Length 26 cm (10 1/4")

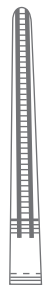

28-444-12
Straight



28-445-12
Curved

DeBakey-Mosquito Atrauma Hemostatic Forcep

Overall Length 12.5 cm (5")

Rib Retractors
Rippensperrer
Separadores costales
Ecarteurs des côtes
Divaricatori costali

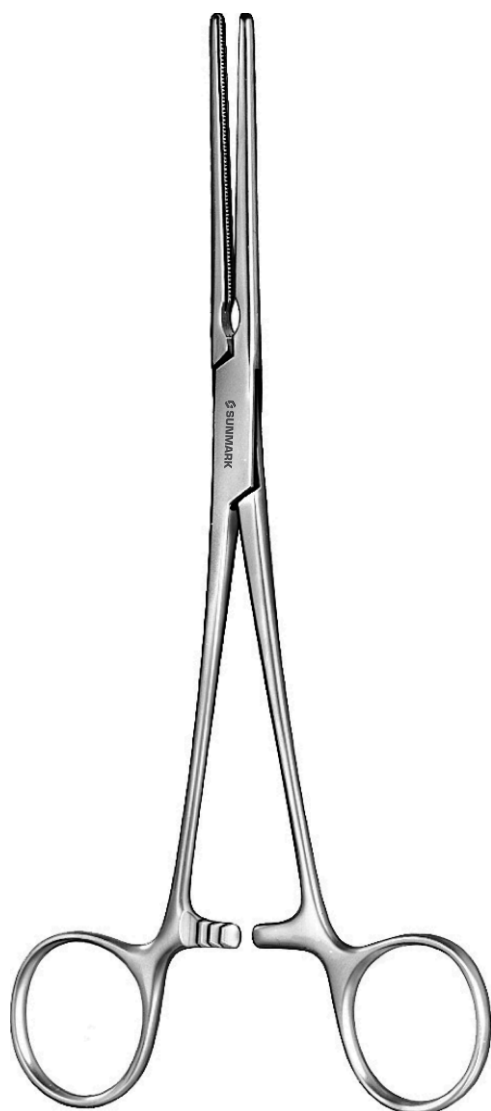

DeBakey-Pean Atrauma Hemostatic Forcep

 atrauma™



28-446-14
Straight
40 mm
14.5 cm (5 3/4")



28-446-16
Straight
45 mm
16.5 cm (6 1/2")



28-446-18
Straight
50 mm
18.5 cm (7 1/4")

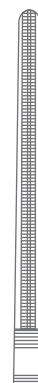

28-446-20
Straight
55 mm
20.5 cm (8")

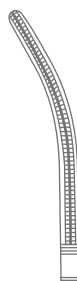

28-447-14
Straight
40 mm
14.5 cm (5 3/4")

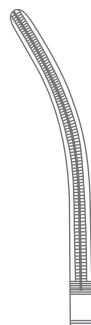

28-447-16
Straight
45 mm
16.5 cm (6 1/2")



28-447-18
Straight
50 mm
18.5 cm (7 1/4")

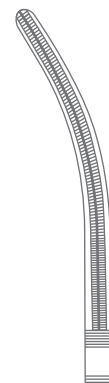

28-447-20
Straight
55 mm
20.5 cm (8")

Cardiovascular Clamps
Kardiovaskuläre Klemmen
Pinzas cardiovasculares
Pincés cardiovasculaires
Pinze cardiovascolari



28-448-17

DeBakey Atrauma Multipurpose Vascular Clamp

50 mm

Overall Length 17 cm (6 3/4")

Atrauma™

Cardiovascular Clamps
Kardiovaskuläre Klemmen
Pinzas cardiovasculares
Pinces cardiovasculaires
Pinze cardiovascolari

Atrauma™



DeBakey Atrauma Multipurpose Vascular Clamp

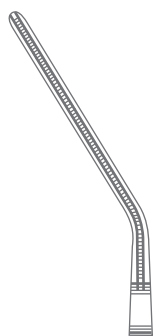

28-449-16
Angled 30°
30 mm
16.5 cm (6 1/2")

28-450-16
Angled 45°
45 mm
16 cm (6 1/4")

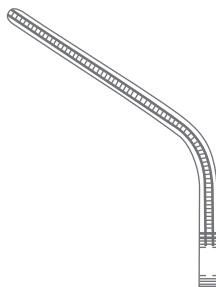

28-451-15
Angled 60°
30 mm
16 cm (6 1/4")

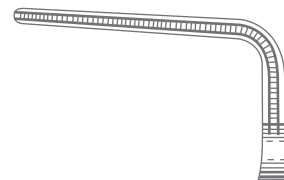

28-453-15
Angled 90°
30 mm
14.5 cm (5 3/4")



Cardiovascular Clamps
Kardiovaskuläre Klemmen
Pinzas cardiovasculares
Pinces cardiovasculaires
Pinze cardiovascolari

Atrauma™

THORAX, CARDIOVASCULAR SURGERY

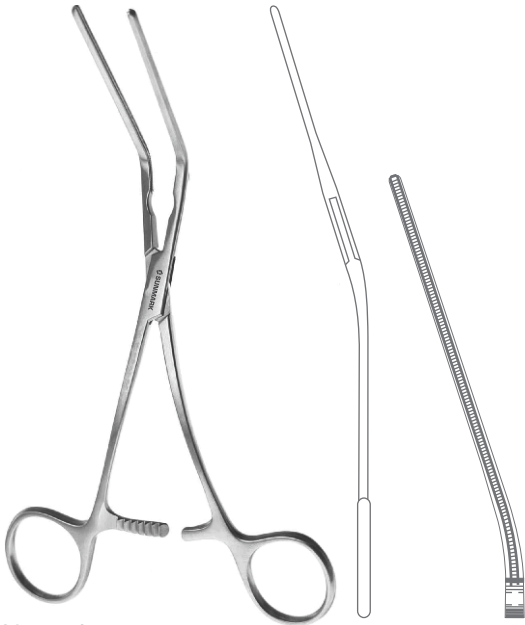

28-455-17

DeBakey Atrauma Multipurpose Vascular Clamp

Angled 15° 50 mm

Overall Length 16.5 cm (6 1/2")



28-457-17

50 mm
17 cm (6 3/4")

28-459-17

63 mm
17.5 cm (7")

Glover Atrauma Multipurpose Vascular Clamp

Cardiovascular Clamps
Kardiovaskuläre Klemmen
Pinzas cardiovasculares
Pinces cardiovasculaires
Pinze cardiovascolari

Atrauma™



Glover Atrauma Multipurpose Vascular Clamp

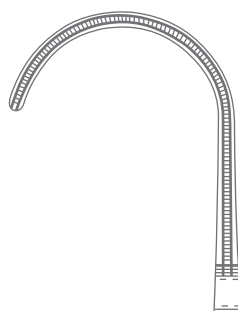

28-461-16
40 mm
16.5 cm (6 1/2")

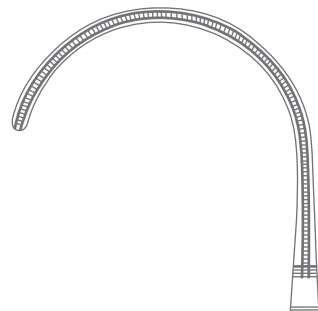

28-463-17
31 mm
17 cm (6 3/4")

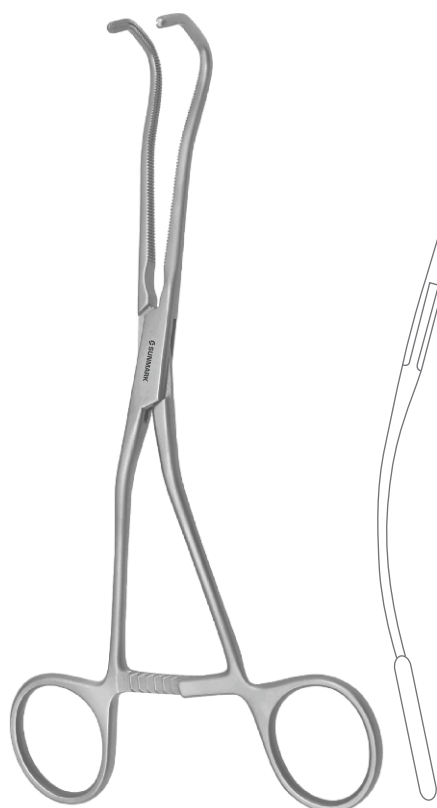

Glover Atrauma Multipurpose Vascular Clamp

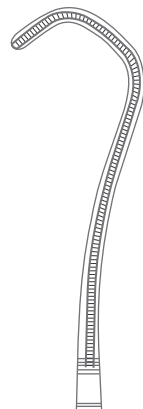

28-465-16
Fig. 1
16 mm
16.5 cm (6 1/2")

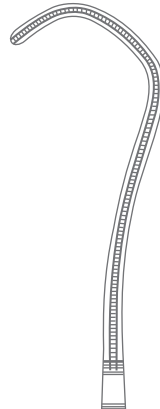

28-465-17
Fig. 2
20 mm
17 cm (6 3/4")

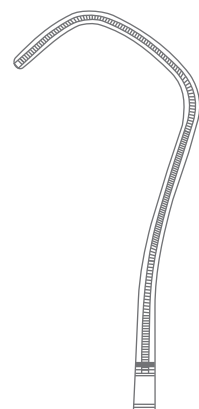

28-465-18
Fig. 3
26 mm
18 cm (7")



Cardiovascular Clamps
Kardiovaskuläre Klemmen
Pinzas cardiovasculares
Pincas cardiovasculaires
Pinze cardiovascolari

Atrauma™

THORAX, CARDIOVASCULAR SURGERY



DeBakey-Beck Atrauma Anastomosis Clamp

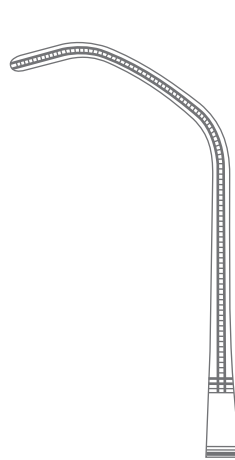

28-467-20
30 mm
20.5 cm (8")

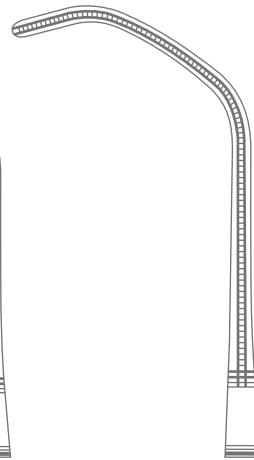

28-467-21
45 mm
21 cm (8 1/4")



Glover Atrauma Anastomosis Clamp

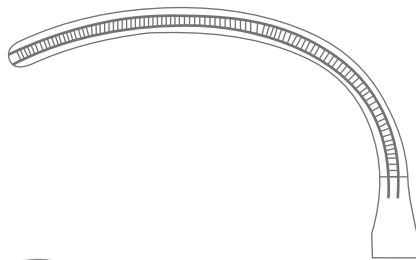

28-469-18
47 mm
18 cm (7")

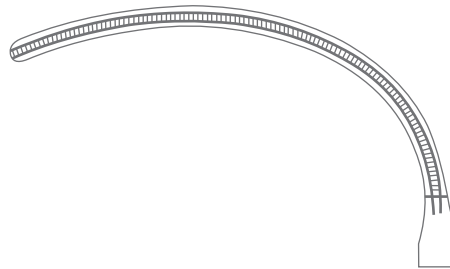

28-469-22
63 mm
22 cm (8 3/4")

Cardiovascular Clamps
Kardiovaskuläre Klemmen
Pinzas cardiovasculares
Pinces cardiovasculaires
Pinze cardiovascolari

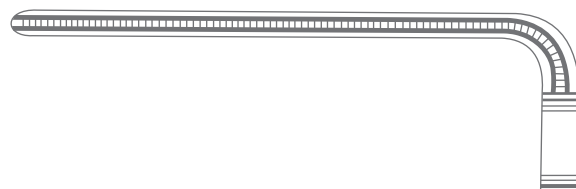
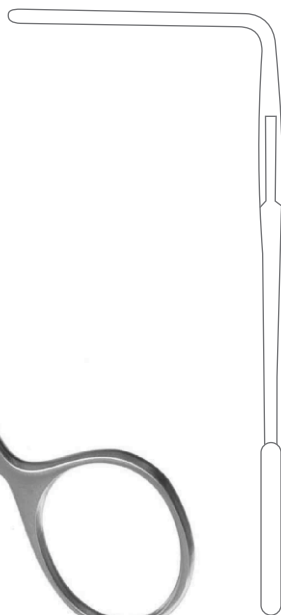

Atrauma™

28-470-10
DeBakey Atrauma Pediatric Vascular Clamp
Angled 90°, 40 mm
Overall Length 10 cm (4")

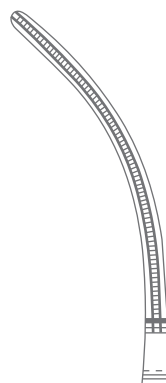
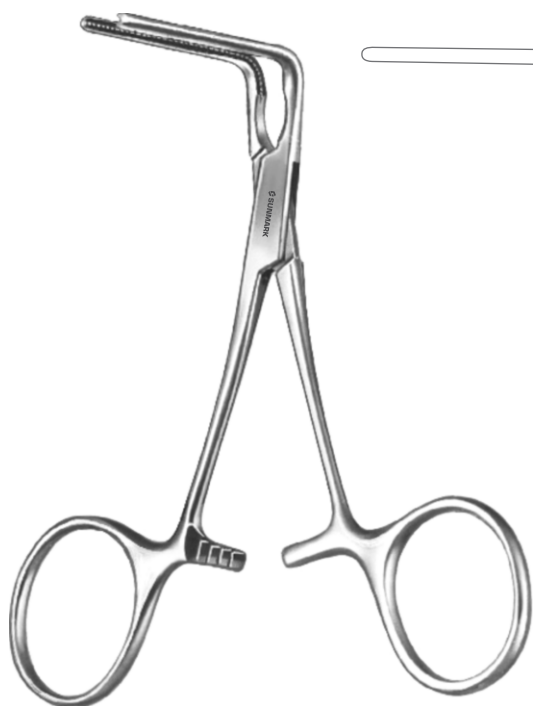

28-471-11
DeBakey Atrauma Pediatric Vascular Clamp
53 mm
Overall Length 12.5 cm (5")

Cardiovascular Clamps
Kardiovaskuläre Klemmen
Pinzas cardiovasculares
Pincas cardiovasculaires
Pinze cardiovascolari

Atrauma™

THORAX, CARDIOVASCULAR SURGERY

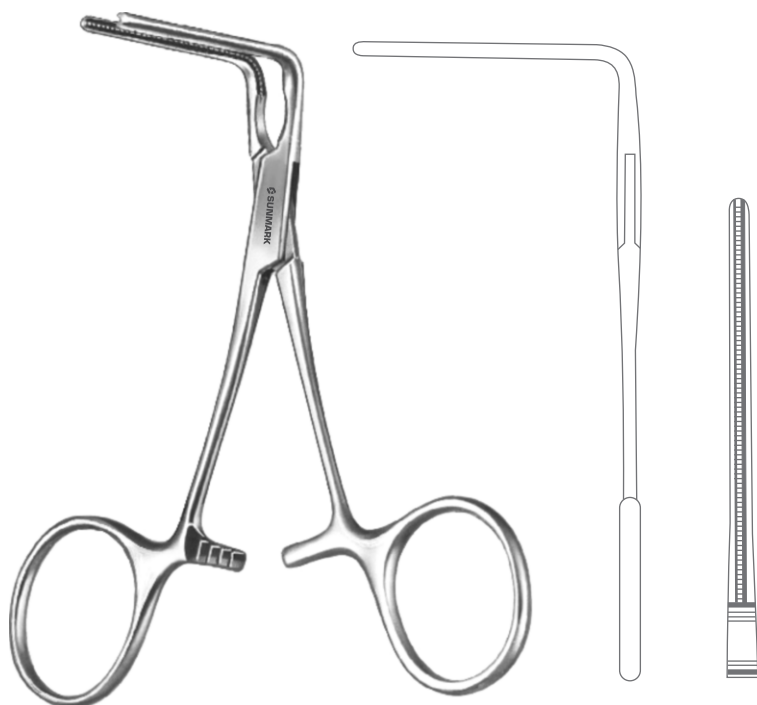

28-473-12

DeBakey Atrauma Pediatric Vascular Clamp

53 mm

Overall Length 13 cm (5")



28-475-12

DeBakey Atrauma Pediatric Vascular Clamp

Curved S Shaped, 53 mm

Overall Length 12.5 cm (5")



Cardiovascular Clamps
Kardiovaskuläre Klemmen
Pinzas cardiovasculares
Pinces cardiovasculaires
Pinze cardiovascolari



28-477-13
DeBakey Atrauma Pediatric Vascular Clamp
Angled 45°, 40 mm
Overall Length 12.5 cm (5")



Cooley-Beck Atrauma Anastomosis Clamp

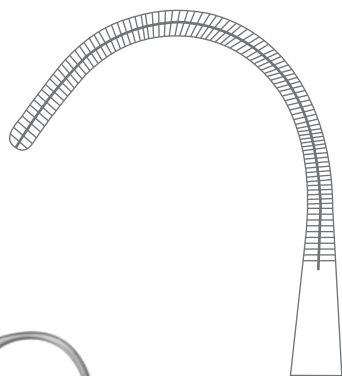

28-481-01
25 mm
15 cm (6")

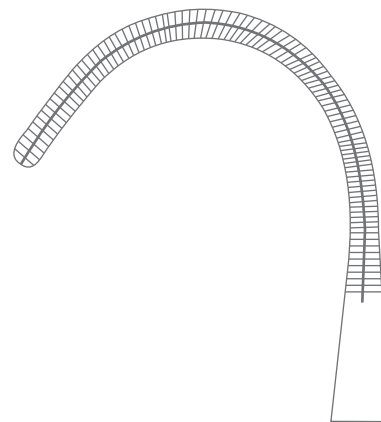

28-481-02
30 mm
15.5 cm (6")

Cardiovascular Clamps
Kardiovaskuläre Klemmen
Pinzas cardiovasculares
Pinces cardiovasculaires
Pinze cardiovascolari

Atrauma™

THORAX, CARDIOVASCULAR SURGERY



28-482-01
Straight
32 mm
14.5 cm (5 3/4")

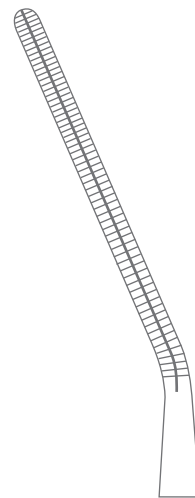

28-482-01
Angled 40°
32 mm
14.5 cm (5 3/4")

Cooley Atrauma Pediatric Vascular Clamp



28-483-03
Cooley Atrauma Pediatric Vascular Clamp
32 mm
Overall Length 14 cm (5 1/2")

Cardiovascular Clamps
Kardiovaskuläre Klemmen
Pinzas cardiovasculares
Pinces cardiovasculaires
Pinze cardiovascolari

Atrauma™



28-483-04
Cooley Atrauma Pediatric Vascular Clamp
18 mm
Overall Length 14 cm (5 1/2")

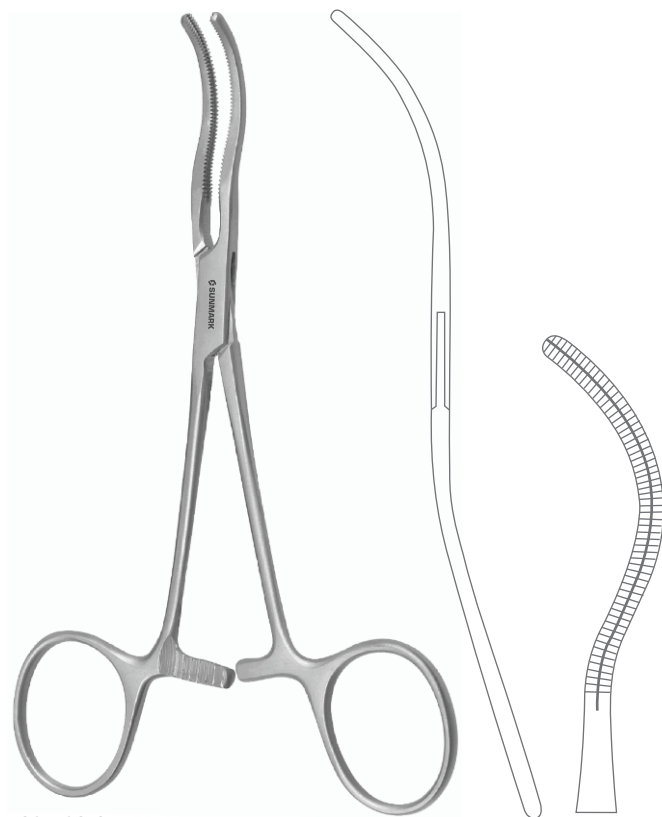

28-483-05
Cooley Atrauma Pediatric Vascular Clamp
30 mm
Overall Length 14.5 cm (5 3/4")

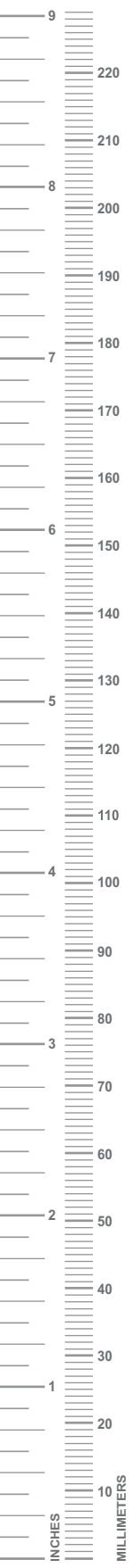

Cardiovascular Clamps
Kardiovaskuläre Klemmen
Pinzas cardiovasculares
Pinces cardiovasculaires
Pinze cardiovascolari

Atrauma™

THORAX, CARDIOVASCULAR SURGERY

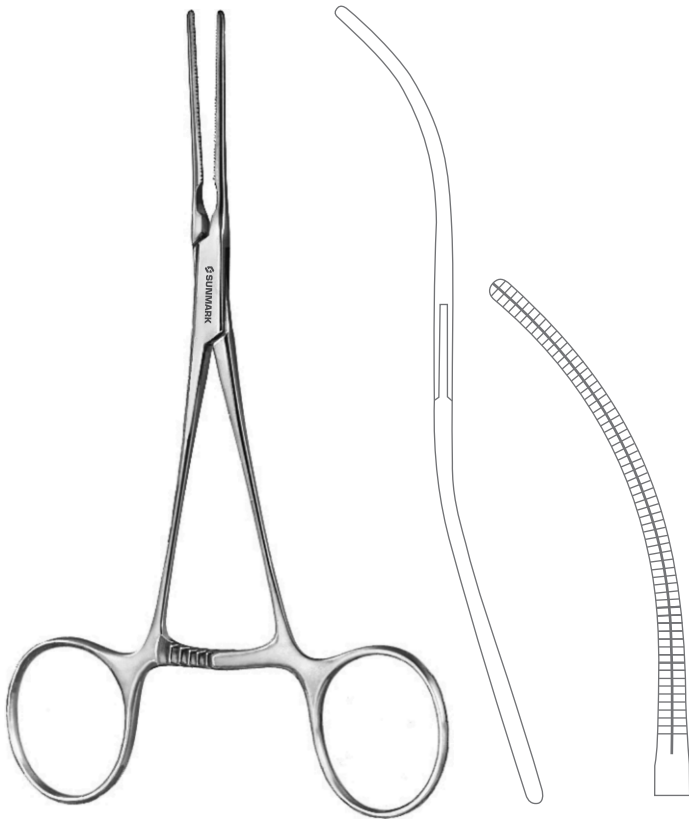

28-483-06

Cooley Atrauma Pediatric Vascular Clamp

30 mm

Overall Length 14 cm (5 1/2")

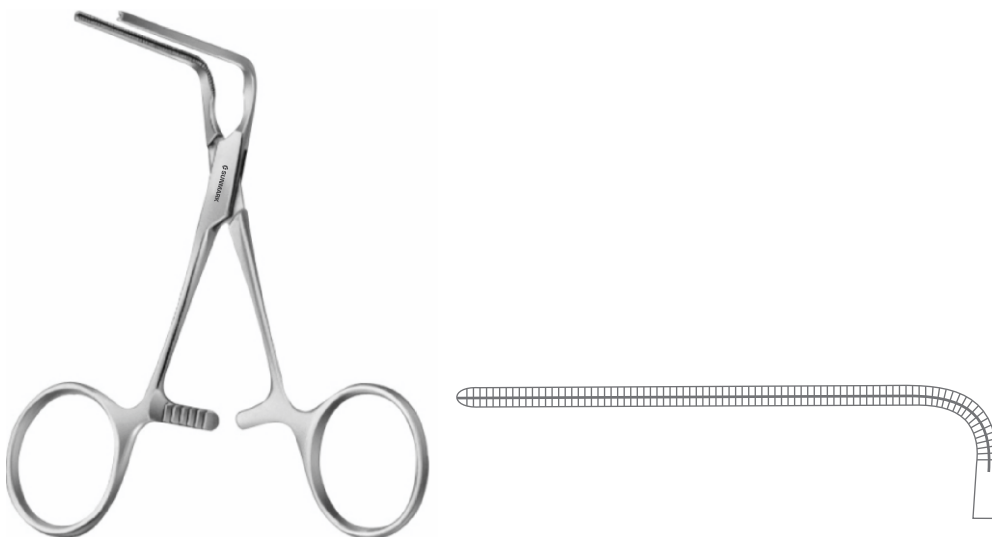

28-483-07

Cooley Atrauma Pediatric Vascular Clamp

Angled 90°, 41 mm

Overall Length 10 cm (4")

Cardiovascular Clamps
Kardiovaskuläre Klemmen
Pinzas cardiovasculares
Pinces cardiovasculaires
Pinze cardiovascolari



Cooley Atrauma Pediatric Vascular Clamp
Overall Length 12.5 cm (5")

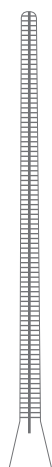

28-483-08
50 mm
Straight

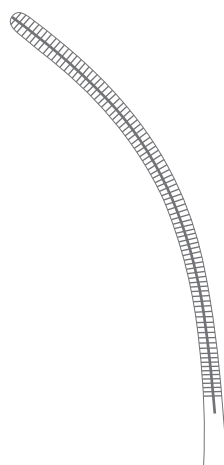

28-483-09
50 mm
Curved



28-483-10
Cooley Atrauma Pediatric Vascular Clamp
52 mm
Overall Length 12.5 cm (5")

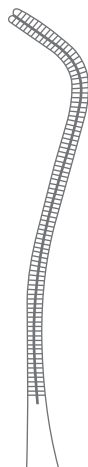

Cardiovascular Clamps
Kardiovaskuläre Klemmen
Pinzas cardiovasculares
Pinces cardiovasculaires
Pinze cardiovascolari

Atrauma™

THORAX, CARDIOVASCULAR SURGERY



28-483-11

Cooley Atrauma Pediatric Vascular Clamp

50 mm

Overall Length 12 cm (5")

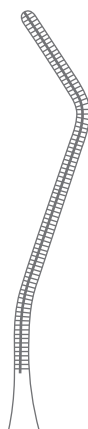

28-485-21

Cooley Atrauma Anastomosis Clamp

Iliac Clamp, 68 mm

Overall Length 22 cm (8 3/4")

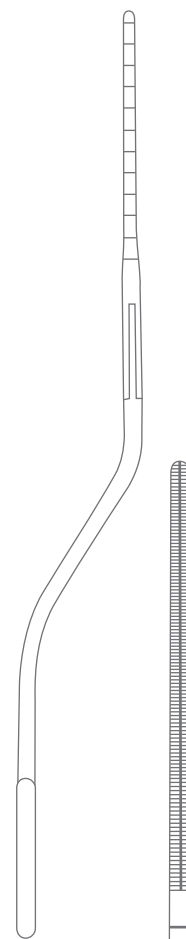

Cardiovascular Clamps
Kardiovaskuläre Klemmen
Pinzas cardiovasculares
Pinces cardiovasculaires
Pinze cardiovascolari



Cooley Atrauma Anastomosis Clamp

Atrauma™

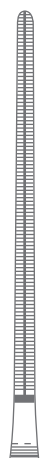

28-488-16
41 mm
16 cm (6 1/4")



28-488-17
52 mm
17 cm (6 3/4")



Cardiovascular Clamps
Kardiovaskuläre Klemmen
Pinzas cardiovasculares
Pinces cardiovasculaires
Pinze cardiovascolari

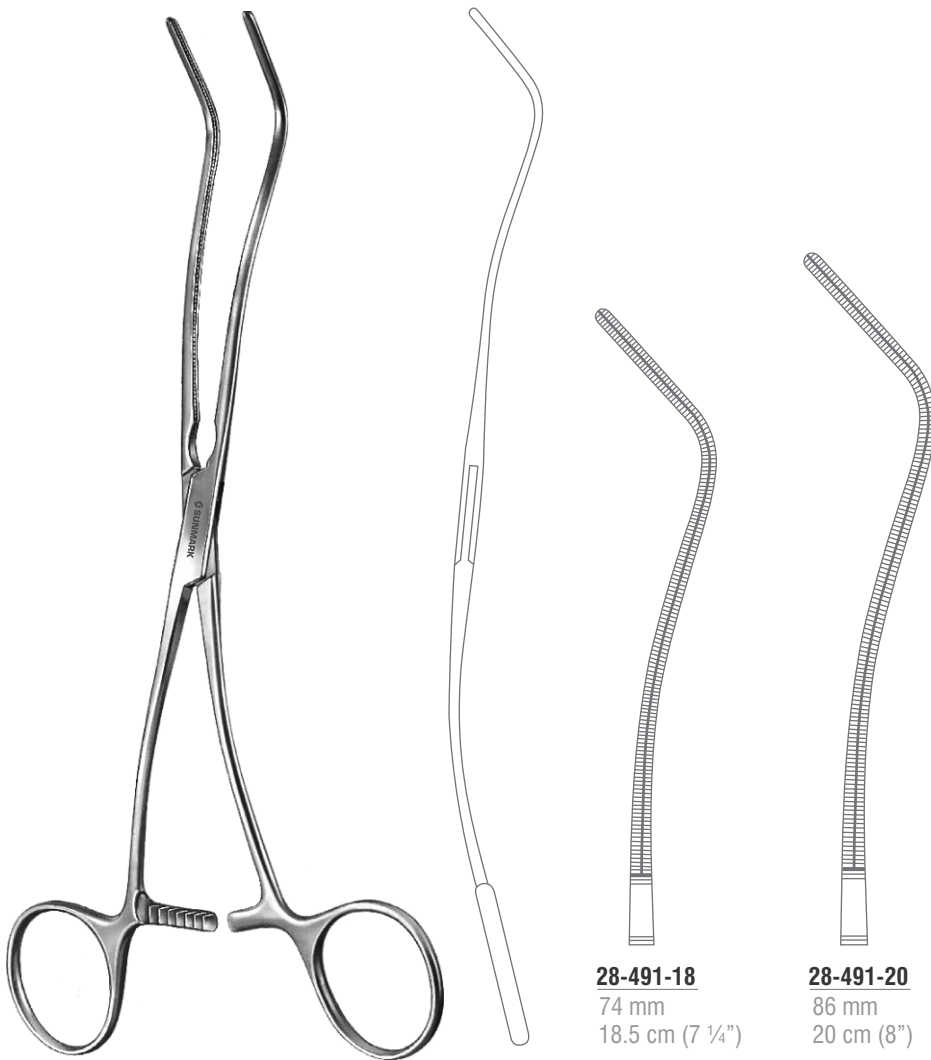

Cooley Atrauma Anastomosis Clamp
Carotid Clamp



Cardiovascular Clamps
Kardiovaskuläre Klemmen
Pinzas cardiovasculares
Pinces cardiovasculaires
Pinze cardiovascolari

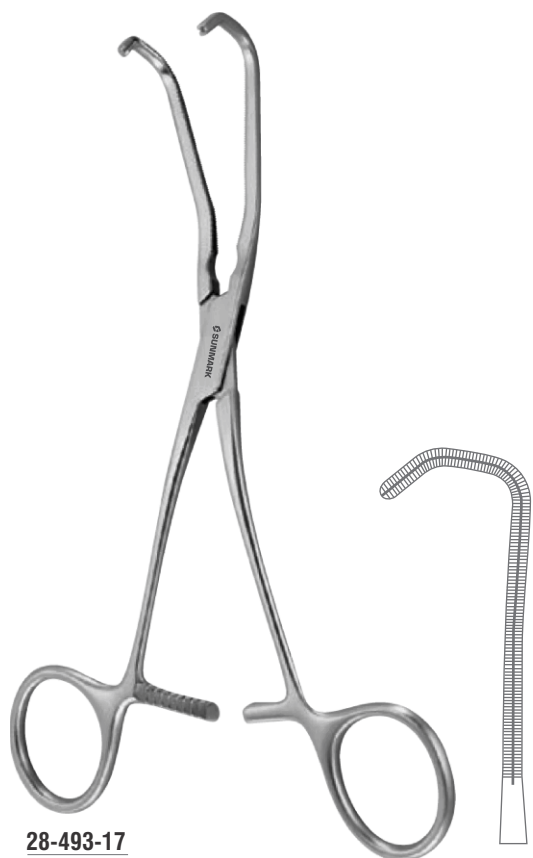

28-493-17
Cooley Atrauma Anastomosis Clamp
17 mm
Overall Length 17 cm (6 3/4")

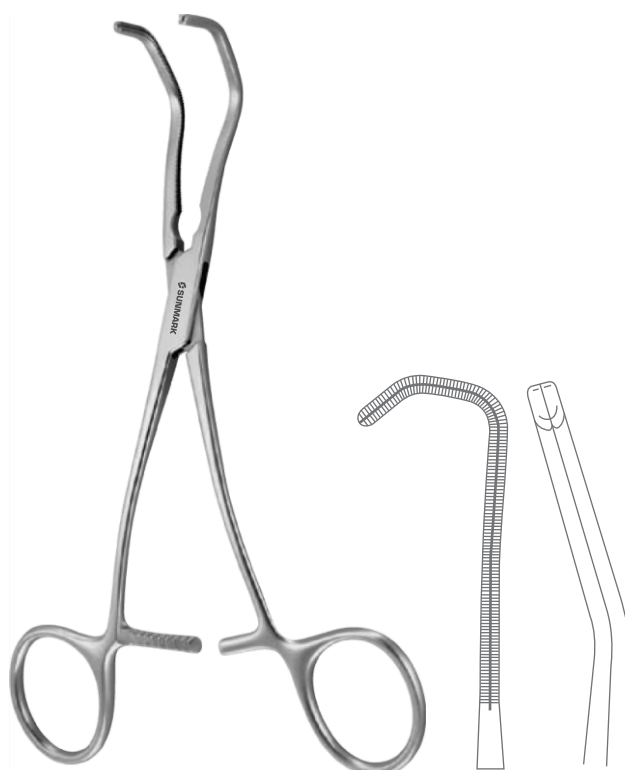

28-495-16
Cooley Atrauma Anastomosis Clamp
20 mm
Overall Length 16 cm (6 1/4")



Cardiovascular Clamps
Kardiovaskuläre Klemmen
Pinzas cardiovasculares
Pincas cardiovasculaires
Pinze cardiovascolari

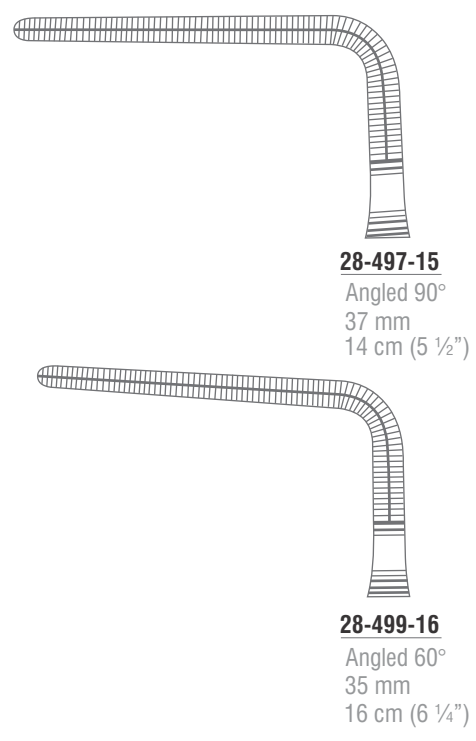

28-497-15
Angled 90°
37 mm
14 cm (5 ½")

28-499-16
Angled 60°
35 mm
16 cm (6 ¼")

Cooley Atrauma Multipurpose Vascular Clamp



Cardiovascular Clamps
Kardiovaskuläre Klemmen
Pinzas cardiovasculares
Pinces cardiovasculaires
Pinze cardiovascolari



28-501-17
Cooley Atrauma Multipurpose Vascular Clamp
Angled 30°, 35 mm
Overall Length 16.5 cm (6 1/2")



Cooley Atrauma Multipurpose Vascular Clamp

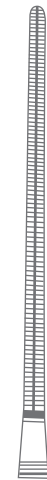

28-503-16
41 mm
16 cm (6 1/4")

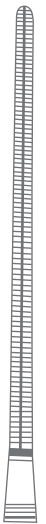

28-503-17
52 mm
17 cm (6 3/4")

Cardiovascular Clamps
Kardiovaskuläre Klemmen
Pinzas cardiovasculares
Pincas cardiovasculaires
Pinze cardiovascolari

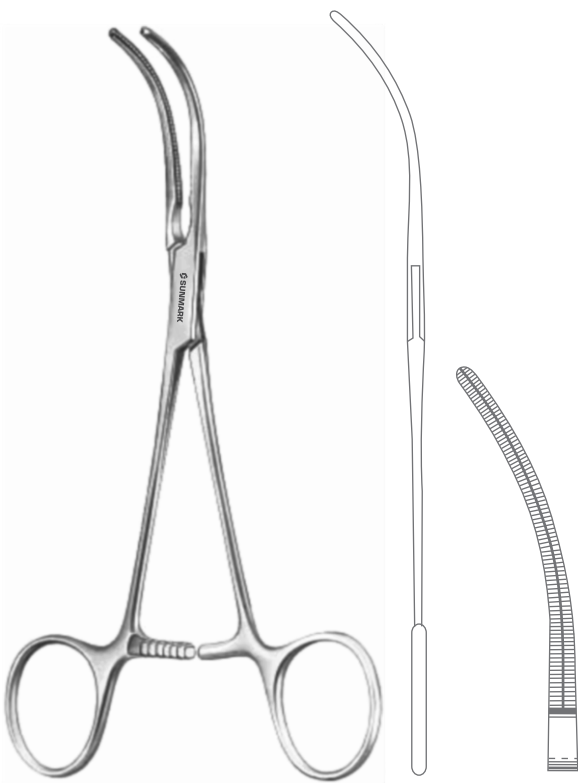

28-505-17
Cooley Atrauma Multipurpose Vascular Clamp
52 mm
Overall Length 17 cm (6 3/4")



28-507-17
Cooley Atrauma Multipurpose Vascular Clamp
63 mm
Overall Length 17.5 cm (7")

Atrauma™

Rib Retractors
Rippensperrer
Separadores costales
Ecarteurs des côtes
Divaricatori costali

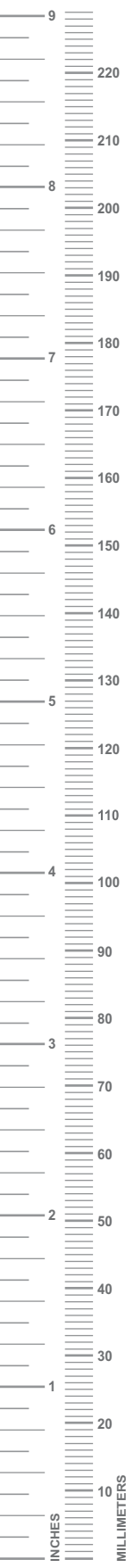

Cooley Atrauma Multipurpose Vascular Clamp

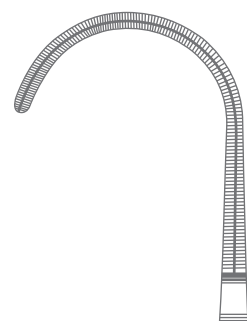

28-509-16
36 mm
16.5 cm (6 1/2")

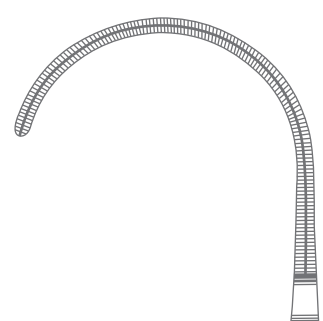

28-509-17
44 mm
17 cm (6 3/4")

Cardiovascular Clamps
Kardiovaskuläre Klemmen
Pinzas cardiovasculares
Pincas cardiovasculaires
Pinze cardiovascolari



Cooley-Derra Atrauma Anastomosis Clamp

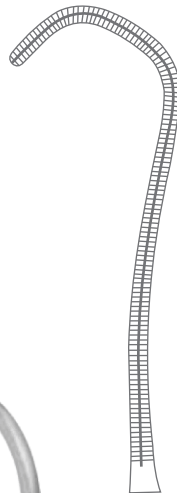

28-511-16
16 mm
16.5 cm (6 1/2")

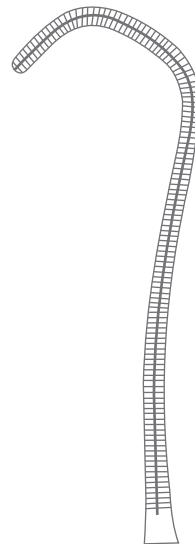

28-511-17
21 mm
17 cm (6 3/4")

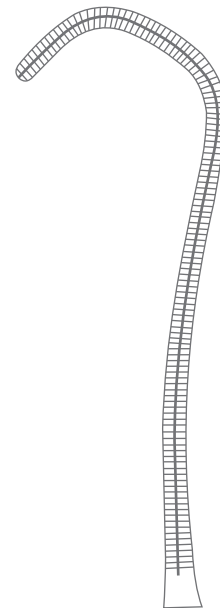

28-511-18
27 mm
17.5 cm (7")

Atrauma™

Cardiovascular Clamps
Kardiovaskuläre Klemmen
Pinzas cardiovasculares
Pincas cardiovasculaires
Pinze cardiovascolari



Cooley-Beck Atrauma Anastomosis Clamp

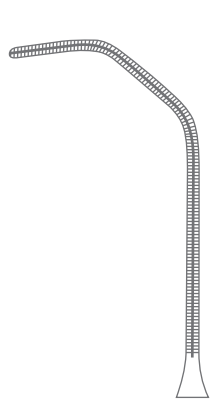

28-513-15
25 mm
16.5 cm (6 1/2")

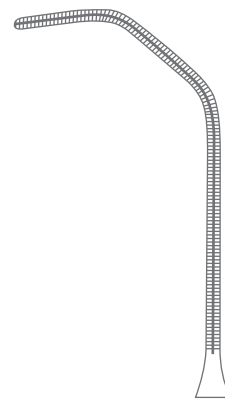

28-513-16
28 mm
16.5 cm (6 1/2")

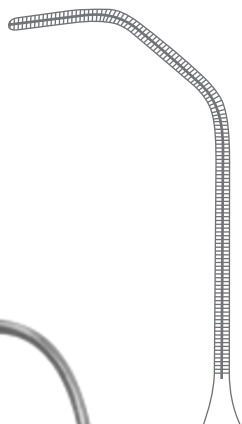

28-513-17
33 mm
17 cm (6 3/4")

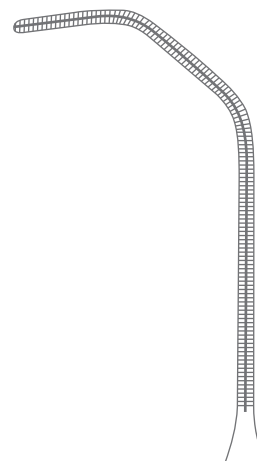

28-513-18
36 mm
18 cm (7")

Cardiovascular Clamps
Kardiovaskuläre Klemmen
Pinzas cardiovasculares
Pincas cardiovasculares
Pinze cardiovascolari

Atrauma™

THORAX, CARDIOVASCULAR SURGERY

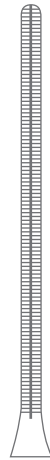

28-515-22
68 mm
22.5 cm (8 ¾")

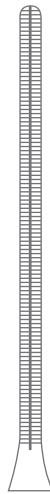

28-515-27
75 mm
27 cm (10 ¾")

Cooley Atrauma Multipurpose Vascular Clamp

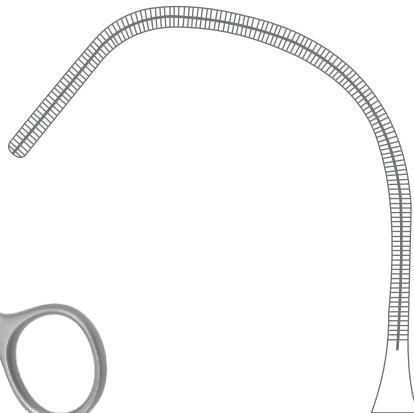

28-517-20
Leitz Atrauma Anastomosis Clamp
43 mm
Overall Length 20.5 cm (8")

Cardiovascular Clamps
Kardiovaskuläre Klemmen
Pinzas cardiovasculares
Pinces cardiovasculaires
Pinze cardiovascolari



28-519-26
Cooley Atrauma Anastomosis Clamp
108 mm
Overall Length 26 cm (10 1/4")

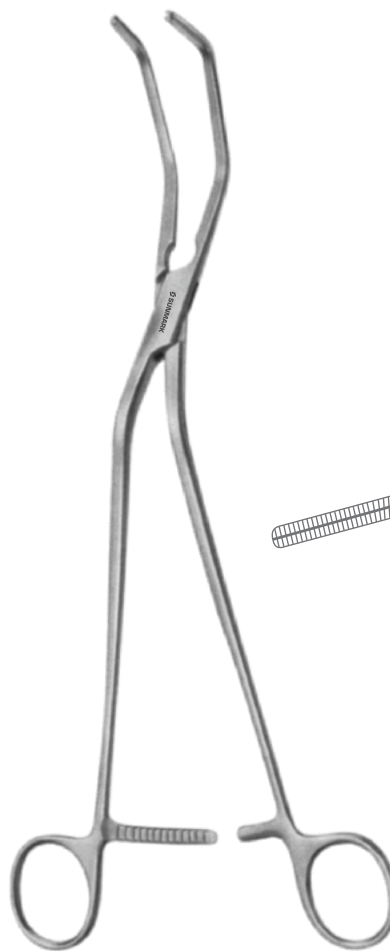
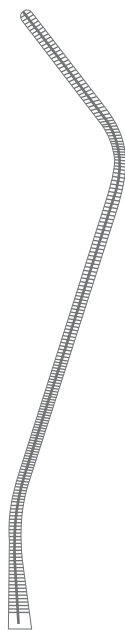

28-521-26
Cooley Atrauma Anastomosis Clamp
58 mm
Overall Length 26 cm (10 1/4")

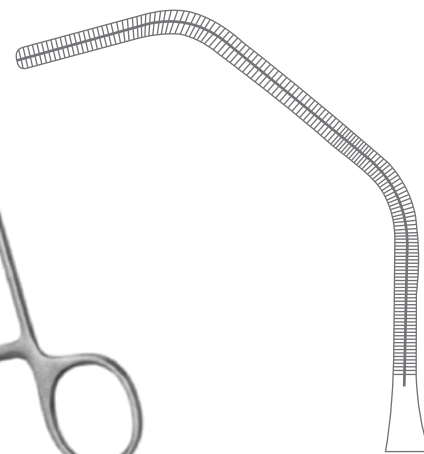

Cardiovascular Clamps
Kardiovaskuläre Klemmen
Pinzas cardiovasculares
Pincés cardiovasculaires
Pinze cardiovascolari

28

THORAX, CARDIOVASCULAR SURGERY

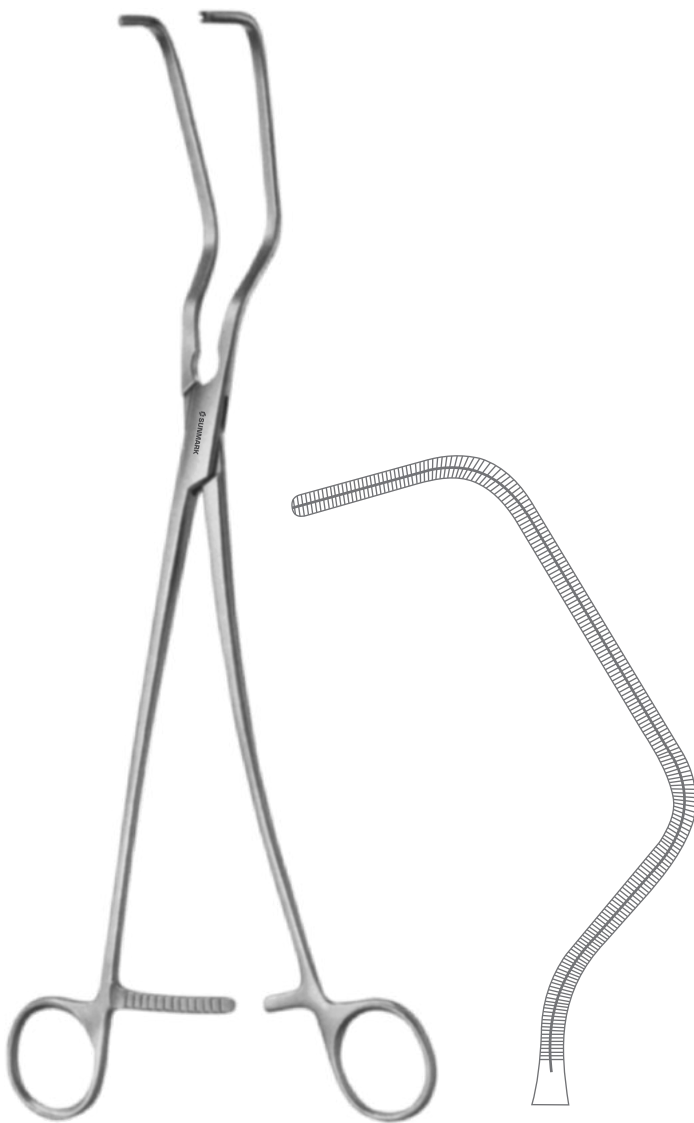

28-523-29

Cooley-Parry Atrauma Anastomosis Clamp

70 mm

Overall Length 29.5 cm (11 ½")

Atrauma™

Cardiovascular Clamps
Kardiovaskuläre Klemmen
Pinzas cardiovasculares
Pinces cardiovasculaires
Pinze cardiovascolari



Cooley Atrauma Anastomosis Clamp

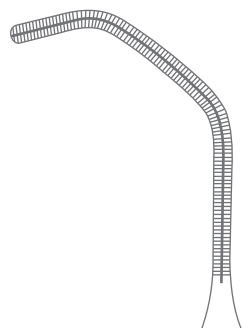

28-525-01
31 mm
20.5 cm (8")

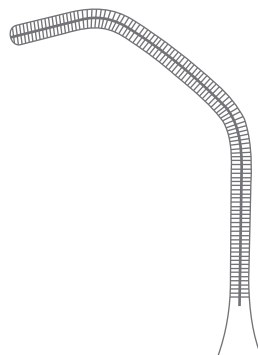

28-525-02
44 mm
26 cm (10 1/4")

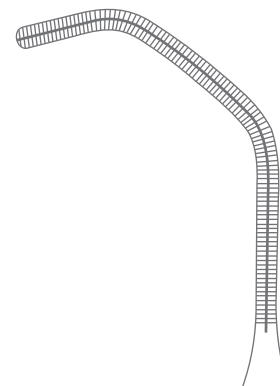

28-525-03
50 mm
26.5 cm (10 1/2")

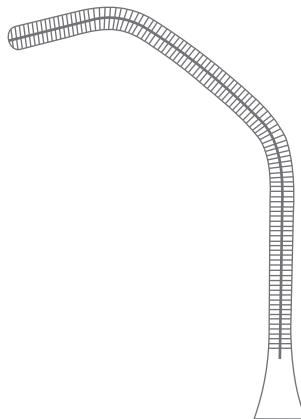

28-525-04
63 mm
26.5 cm (10 1/2")

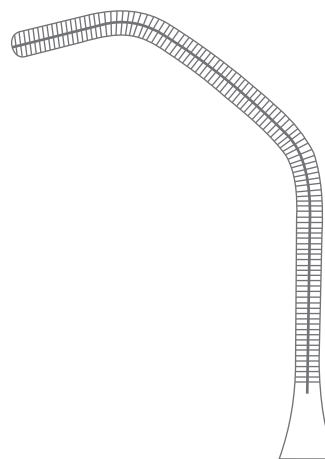

28-525-05
78 mm
27.5 cm (10 3/4")

Cardiovascular Clamps
Kardiovaskuläre Klemmen
Pinzas cardiovasculares
Pincas cardiovasculaires
Pinze cardiovascolari

THORAX, CARDIOVASCULAR SURGERY



28-527-32
Cooley Atrauma Aortic Clamp
115 mm
Overall Length 32 cm (12 ½")

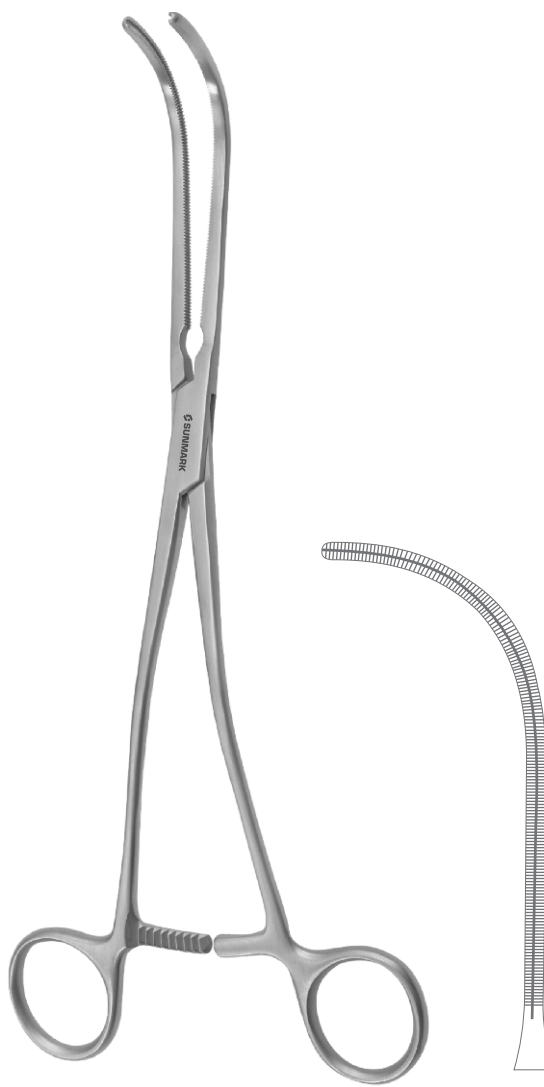

28-529-28
Cooley Atrauma Multipurpose Vascular Clamp
82 mm
Overall Length 28.5 cm (11 ¼")

Atrauma™



Cardiovascular Clamps
Kardiovaskuläre Klemmen
Pinzas cardiovasculares
Pinces cardiovasculaires
Pinze cardiovascolari

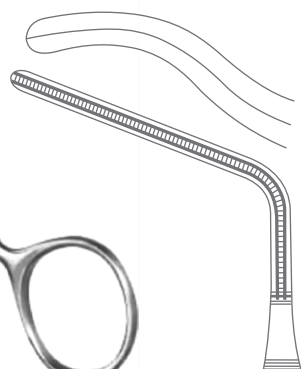
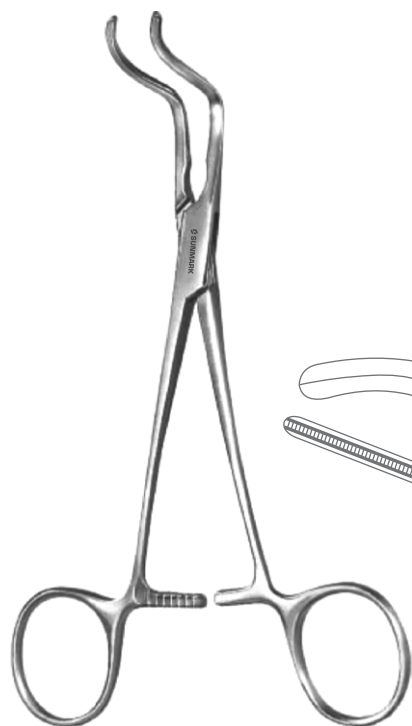

28-535-15
Subramanian-Miniature Atrauma Aortic Clamp
Angled 135°, 30 mm
Overall Length 15.5 cm (6")

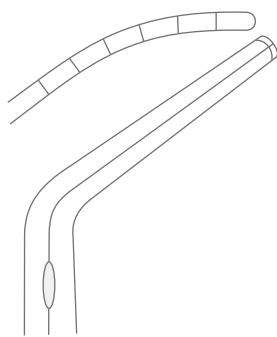

28-537-01
Right

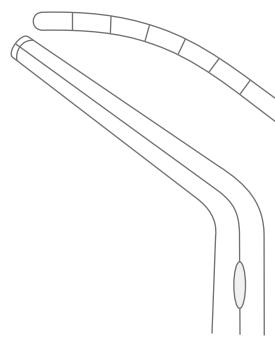

28-537-01
Left

Subramanian Atrauma Aortic Clamp
Overall Length 16 cm (6 1/4")

Cardiovascular Clamps
Kardiovaskuläre Klemmen
Pinzas cardiovasculares
Pincas cardiovasculaires
Pinze cardiovascolari



Subramanian Atrauma Aortic Clamp
Overall Length 13.5 cm (5 1/4")

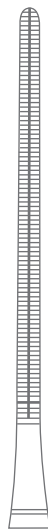

28-541-01
Straight
Fig. 1, 50 mm

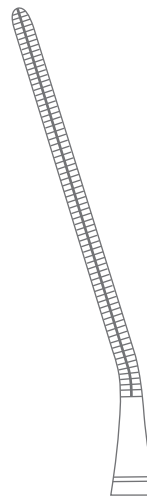

28-541-02
Angled 30°
Fig. 2, 33 mm

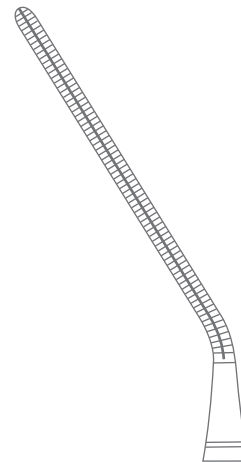

28-541-03
Angled 45°
Fig. 3, 31 mm

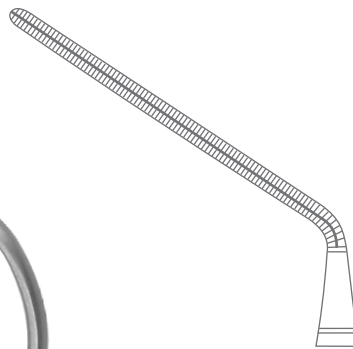

28-541-04
Angled 60°
Fig. 4, 31 mm

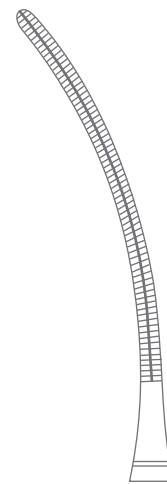

28-541-05
Curved
Fig. 5, 50 mm



Cardiovascular Clamps
Kardiovaskuläre Klemmen
Pinzas cardiovasculares
Pincas cardiovasculaires
Pinze cardiovascolari



Cooley Atrauma Pediatric Clamp

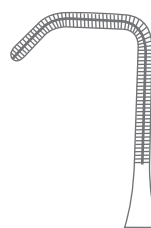

28-541-06
13 mm, Fig. 6
12.5 cm (5")

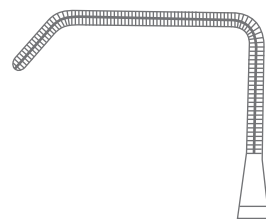

28-541-07
24 mm, Fig. 7
13.5 cm (5 1/4")

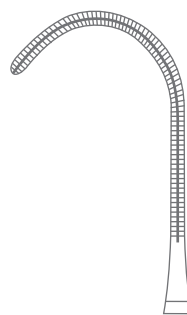

28-541-08
19 mm, Fig. 8
13.5 cm (5 1/4")

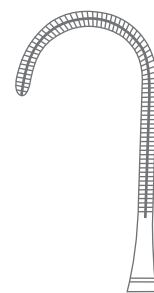

28-541-09
12 mm, Fig. 9
13.5 cm (5 1/4")

Cardiovascular Clamps
Kardiovaskuläre Klemmen
Pinzas cardiovasculares
Pincas cardiovasculaires
Pinze cardiovascolari

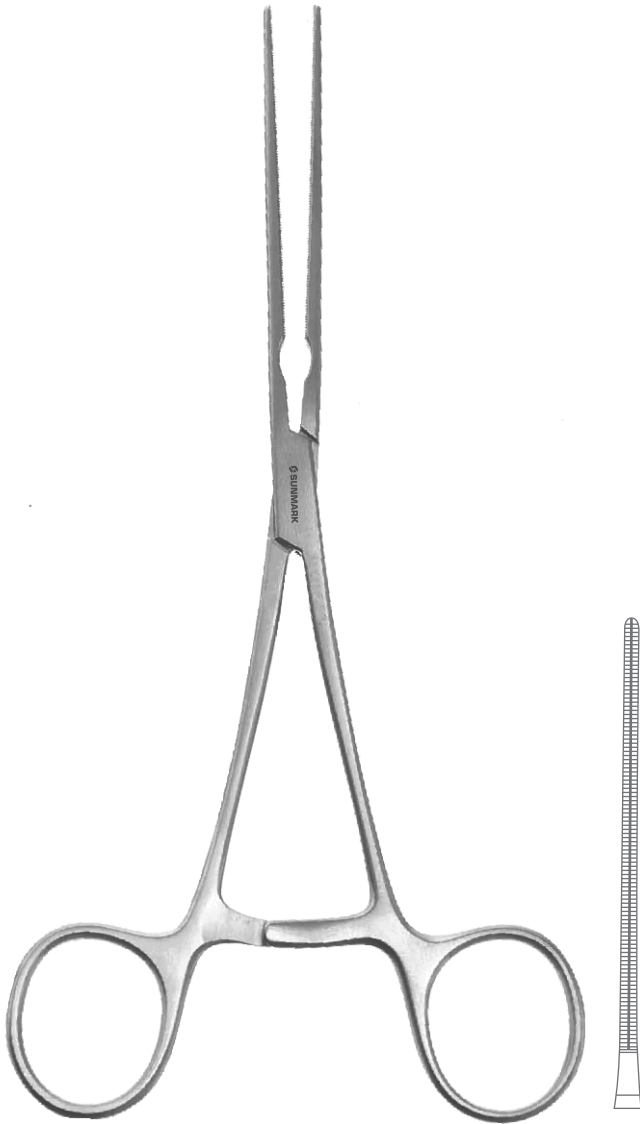

28-544-16
Cooley Atrauma Pediatric Clamp
52 mm
Overall Length 16.5 cm (6 1/2")

Atrauma

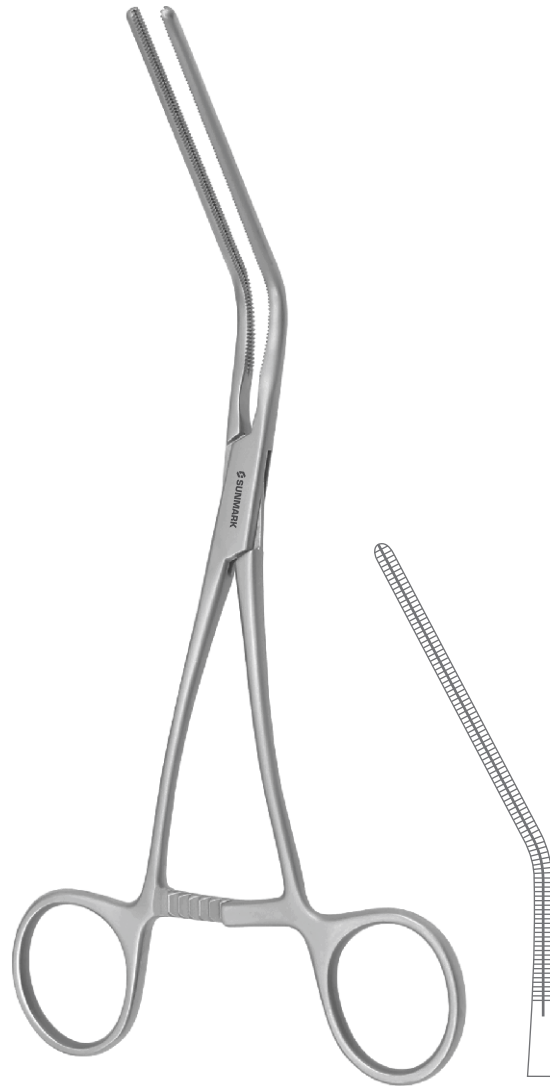

28-545-16
Cooley Atrauma Pediatric Clamp
35 mm
Overall Length 16 cm (6 1/4")

Atrauma

Cardiovascular Clamps
Kardiovaskuläre Klemmen
Pinzas cardiovasculares
Pinces cardiovasculaires
Pinze cardiovascolari

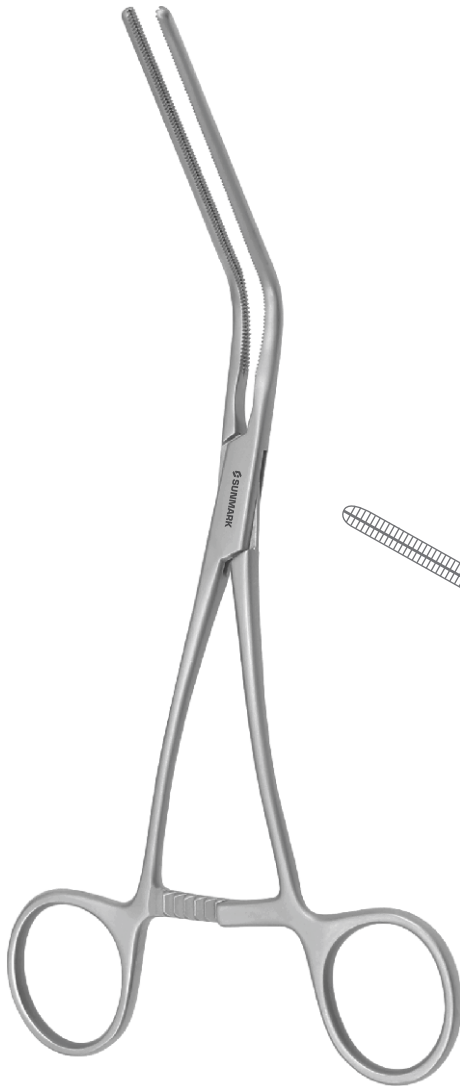

Cooley Atrauma Pediatric Clamp

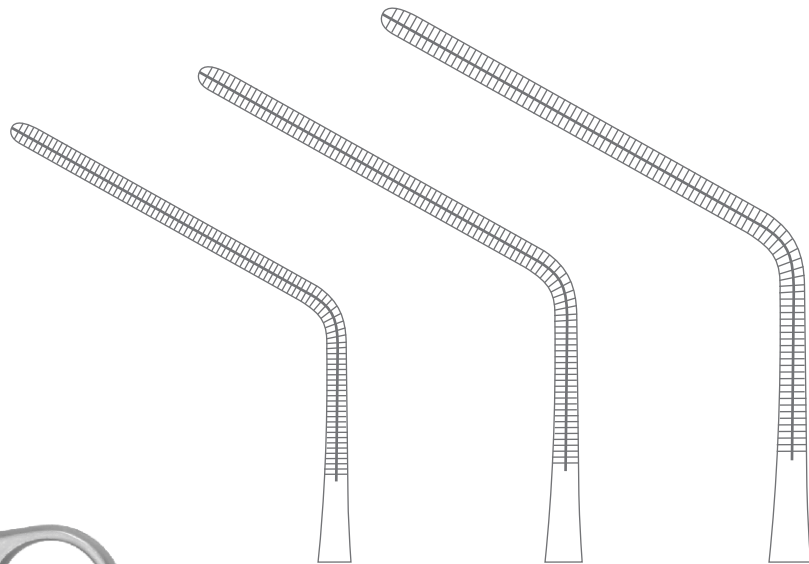

28-547-16
Angled 60°
40 mm
15.5 cm (6")

28-547-17
Angled 60°
52 mm
17 cm (7 3/4")

28-547-18
Angled 60°
70 mm
18.5 cm (7 1/4")

Cardiovascular Clamps
Kardiovaskuläre Klemmen
Pinzas cardiovasculares
Pincas cardiovasculaires
Pinze cardiovascolari

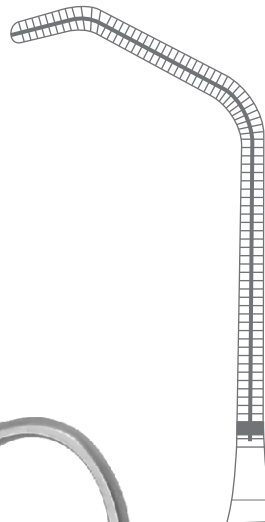
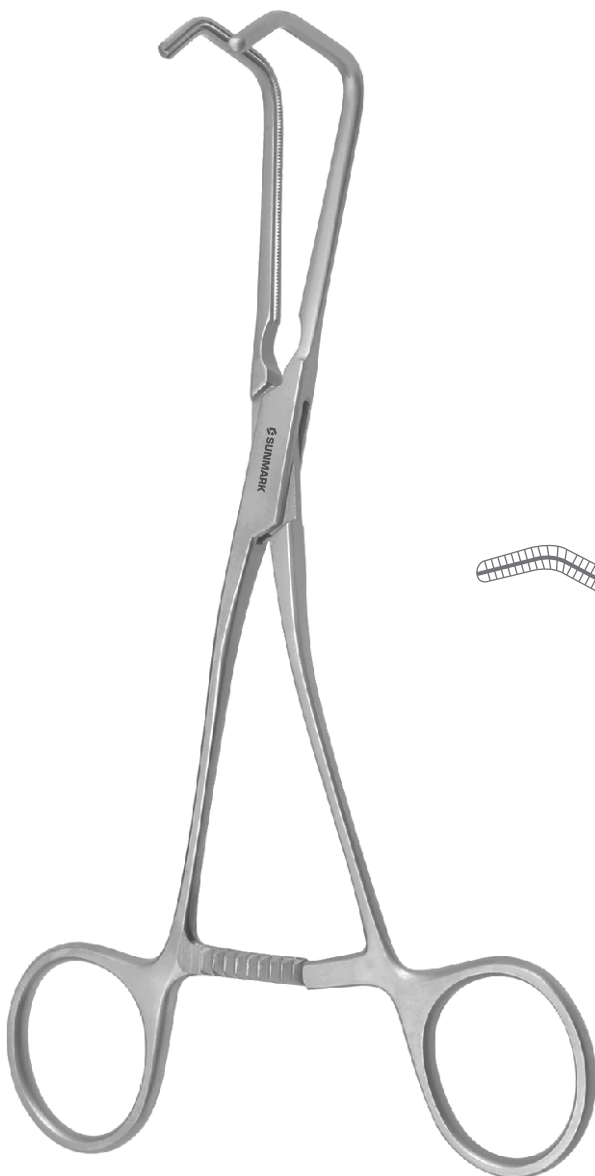

28-549-15
23 mm
15.5 cm (6")

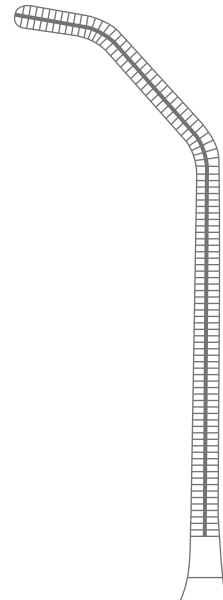

28-551-16
24 mm
16 cm (6 1/4")

Cooley Atrauma Pediatric Clamp



Cardiovascular Clamps
 Kardiovaskuläre Klemmen
 Pinzas cardiovasculares
 Pincas cardiovasculaires
 Pinze cardiovascolari

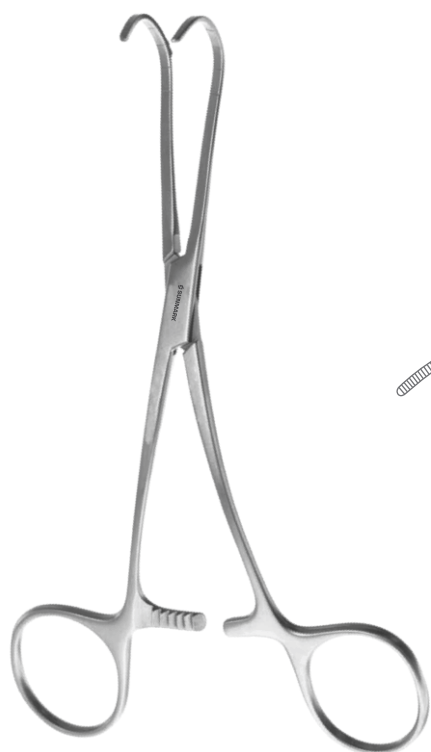

Castaneda Atrauma Neonatal Vascular Clamp

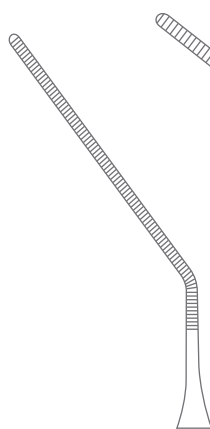

28-553-01
 Angled 30°
 33 mm
 12.5 cm (5")

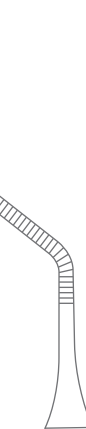

28-553-02
 Angled 45°
 31 mm
 11.5 cm (4 1/2")

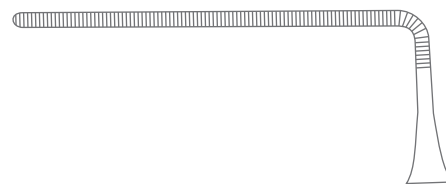

28-553-03
 Angled 90°
 41 mm
 11 cm (4 1/4")

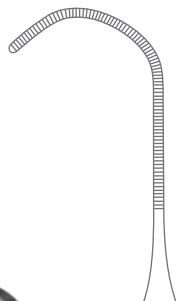

28-555-01
 15 mm
 11.5 cm (4 1/2")

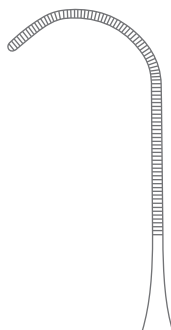

28-555-02
 18 mm
 12 cm (4 3/4")

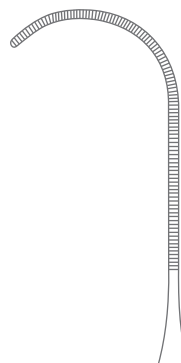

28-555-03
 23 mm
 12 cm (4 3/4")

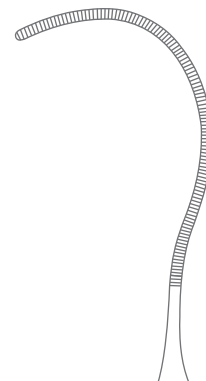

28-557-04
 25 mm
 12 cm (4 3/4")

Cardiovascular Clamps
Kardiovaskuläre Klemmen
Pinzas cardiovasculares
Pinces cardiovasculaires
Pinze cardiovascolari

THORAX, CARDIOVASCULAR SURGERY

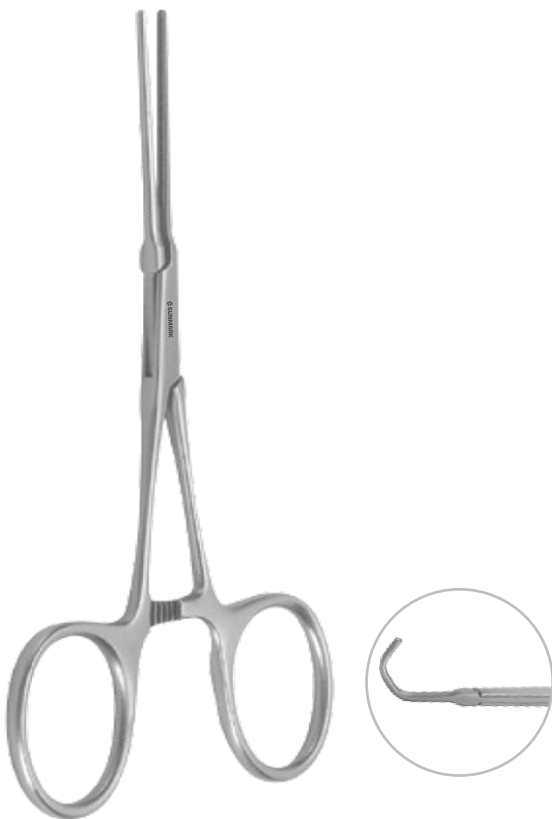

28-561-01

DeBakey Atrauma Neonatal Vascular Clamp

Slightly Angled Shank, Jaw Length 14 mm With 6 mm Jaws
Overall Length 10.5 cm (4")



28-561-01 T

DeBakey Atrauma Neonatal Vascular Clamp

Slightly Angled Shank, Jaw Length 14 mm With 6 mm Jaws
Overall Length 10.5 cm (4")



Cardiovascular Clamps
Kardiovaskuläre Klemmen
Pinzas cardiovasculares
Pinces cardiovasculaires
Pinze cardiovascolari



28-561-02
DeBakey Atrauma Neonatal Vascular Clamp
Straight Shank With Spoon Shaped
Jaw Length 14 mm With 6 mm Jaws
Overall Length 10.5 cm (4")



28-561-02 T
DeBakey Atrauma Neonatal Vascular Clamp
Straight Shank With Spoon Shaped
Jaw Length 14 mm With 6 mm Jaws
Overall Length 10.5 cm (4")



Rib Retractors
Rippensperrer
Separadores costales
Ecarteurs des côtes
Divaricatori costali



28-561-03

DeBakey Atrauma Neonatal Vascular Clamp

Slightly Angled Shanks
Jaw Length 16 mm With 9 mm Jaws
Overall Length 10.5 cm (4")



28-561-03 T

DeBakey Atrauma Neonatal Vascular Clamp

Slightly Angled Shanks
Jaw Length 16 mm With 9 mm Jaws
Overall Length 10.5 cm (4")

Rib Retractors
Rippensperrer
Separadores costales
Ecarteurs des côtes
Divaricatori costali

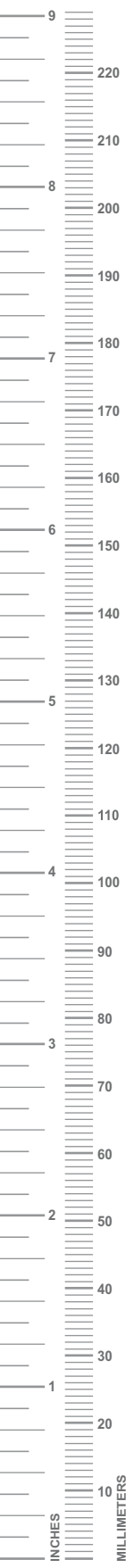

28-561-04
DeBakey Atrauma Neonatal Vascular Clamp
Slightly Angled Shanks
Jaw Length 22 mm With 6 mm Jaws
Overall Length 11.5 cm (4 ½")



28-561-04 T
DeBakey Atrauma Neonatal Vascular Clamp
Slightly Angled Shanks
Jaw Length 22 mm With 6 mm Jaws
Overall Length 11.5 cm (4 ½")

Rib Retractors
Rippensperrer
Separadores costales
Ecarteurs des côtes
Divaricatori costali



28-561-05

DeBakey Atrauma Neonatal Vascular Clamp

Slightly Angled Shanks

Jaw Length 20 mm With 9 mm Jaws

Overall Length 11.5 cm (4 ½")

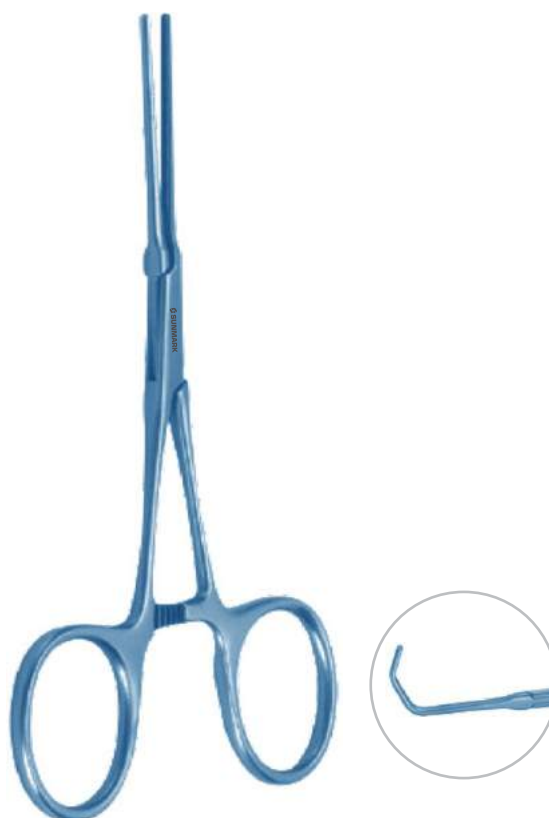

28-561-05 T

DeBakey Atrauma Neonatal Vascular Clamp

Slightly Angled Shanks

Jaw Length 20 mm With 9 mm Jaws

Overall Length 11.5 cm (4 ½")

Rib Retractors
Rippensperrer
Separadores costales
Ecarteurs des côtes
Divaricatori costali



28-561-06
DeBakey Atrauma Neonatal Vascular Clamp
Straight Shanks With Spoon Shaped
Jaw Length 26 mm With 6 mm Jaws
Overall Length 12 cm (4 3/4")



28-561-06 T
DeBakey Atrauma Neonatal Vascular Clamp
Straight Shanks With Spoon Shaped
Jaw Length 26 mm With 6 mm Jaws
Overall Length 12 cm (4 3/4")

Rib Retractors
Rippensperrer
Separadores costales
Ecarteurs des côtes
Divaricatori costali

THORAX, CARDIOVASCULAR SURGERY



28-563-01

DeBakey Atrauma Neonatal Vascular Clamp

45° Angles Jaws
Jaw Length 25 mm
Overall Length 11 cm (4 1/4")



28-563-01 T

DeBakey Atrauma Neonatal Vascular Clamp

45° Angles Jaws
Jaw Length 25 mm
Overall Length 11 cm (4 1/4")



Cardiovascular Clamps
Kardiovaskuläre Klemmen
Pinzas cardiovasculares
Pinces cardiovasculaires
Pinze cardiovascolari



28-563-02

DeBakey Atrauma Neonatal Vascular Clamp

45°Angles Jaws
Jaw Length 30 mm
Overall Length 11.5 cm (4 1/2")

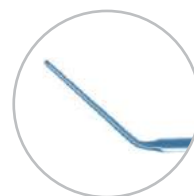

28-563-02 T

DeBakey Atrauma Neonatal Vascular Clamp

45°Angles Jaws
Jaw Length 30 mm
Overall Length 11.5 cm (4 1/2")

Cardiovascular Clamps
Kardiovaskuläre Klemmen
Pinzas cardiovasculares
Pincas cardiovasculaires
Pinze cardiovascolari



28-563-03

DeBakey Atrauma Neonatal Vascular Clamp

60°Angles Jaws
Jaw Length 23 mm
Overall Length 10.5 cm (4")



28-563-03 T

DeBakey Atrauma Neonatal Vascular Clamp

60°Angles Jaws
Jaw Length 23 mm
Overall Length 10.5 cm (4")

Cardiovascular Clamps
Kardiovaskuläre Klemmen
Pinzas cardiovasculares
Pinces cardiovasculaires
Pinze cardiovascolari



28-564-01
DeBakey Atrauma Neonatal Vascular Clamp
Straight Shanks
Jaw Length 30 mm
Overall Length 12 cm (4 3/4")



28-564-01 T
DeBakey Atrauma Neonatal Vascular Clamp
Straight Shanks
Jaw Length 30 mm
Overall Length 12 cm (4 3/4")

Cardiovascular Clamps
Kardiovaskuläre Klemmen
Pinzas cardiovasculares
Pinces cardiovasculaires
Pinze cardiovascolari

THORAX, CARDIOVASCULAR SURGERY



28-565-01

DeBakey Atrauma Neonatal Vascular Clamp

Slightly Angles Shanks
Jaw Length 30 mm
Overall Length 12 cm (4 ¾")



28-565-01 T

DeBakey Atrauma Neonatal Vascular Clamp

Slightly Angles Shanks
Jaw Length 30 mm
Overall Length 12 cm (4 ¾")



Cardiovascular Clamps
Kardiovaskuläre Klemmen
Pinzas cardiovasculares
Pinces cardiovasculaires
Pinze cardiovascolari



28-565-02
DeBakey Atrauma Neonatal Vascular Clamp
Angled Shanks
Jaw Length 22 mm
Overall Length 11 cm (4 1/4")



28-565-02 T
DeBakey Atrauma Neonatal Vascular Clamp
Angled Shanks
Jaw Length 22 mm
Overall Length 11 cm (4 1/4")

Cardiovascular Clamps
Kardiovaskuläre Klemmen
Pinzas cardiovasculares
Pincas cardiovasculaires
Pinze cardiovascolari



28-565-03

DeBakey Atrauma Neonatal Vascular Clamp

Angled Shanks
Jaw Length 30 mm
Overall Length 12 cm (4 ¾")



28-565-03 T

DeBakey Atrauma Neonatal Vascular Clamp

Angled Shanks
Jaw Length 30 mm
Overall Length 12 cm (4 ¾")



Cardiovascular Clamps
Kardiovaskuläre Klemmen
Pinzas cardiovasculares
Pinces cardiovasculaires
Pinze cardiovascolari



Bailey Aortic Valve Rongeur
Overall Length 12 cm (4 3/4")

28-591-01

Straight
Bite Size 3 x 7

28-591-02

25°Down Shaft Length
Bite Size 3 x 7

28-591-03

70°Down Shaft Length
Bite Size 3 x 7

28-591-04

90°Down Shaft Length
Bite Size 3 x 7

28-591-05

45°Left Shaft Length
Bite Size 3 x 7

28-591-06

45°Right Shaft Length
Bite Size 3 x 7

28-591-07

25°Up Shaft Length
Bite Size 3 x 7

Vascular Dilators
Gefäßdilatoren
Dilatadores vasculares
Dilateurs vasculaires
Dilatatori vascolari

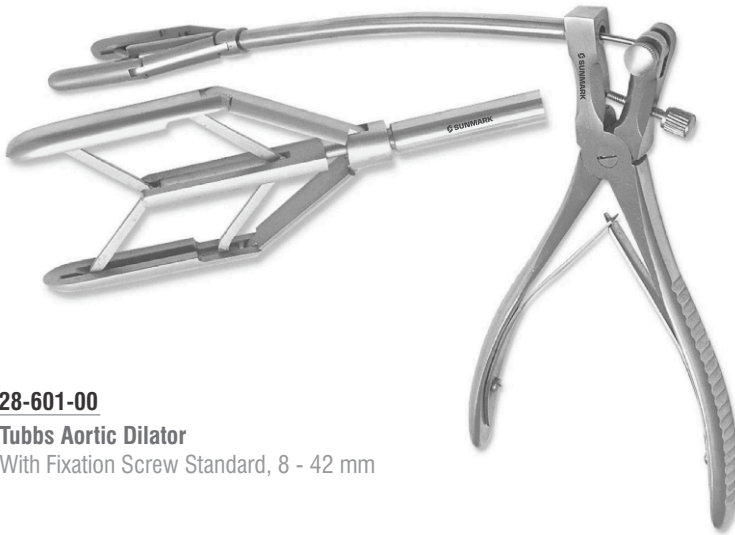

28-601-00
Tubbs Aortic Dilator
With Fixation Screw Standard, 8 - 42 mm

28-601-00
Cooley Vascular Dilator
Set of 8 Ref: 28-612-05 to 28-612-50
Overall Length 13 cm (5")

- 28-612-05** Ø 0.5 mm
- 28-612-10** Ø 1.0 mm
- 28-612-15** Ø 1.5 mm
- 28-612-20** Ø 2.0 mm
- 28-612-25** Ø 2.5 mm
- 28-612-30** Ø 3.0 mm
- 28-612-40** Ø 4.0 mm
- 28-612-50** Ø 5.0 mm



Vascular Dilators
 Gefäßdilatoren
 Dilatadores vasculares
 Dilatateurs vasculaires
 Dilatatori vascolari



28-620-00

Cooley Vascular Dilator

Set of 12 Ref: 28-622-05 to 28-622-90
 Overall Length 19 cm (7 ½")

- 28-622-05** Ø 0.5 mm
- 28-622-10** Ø 1.0 mm
- 28-622-15** Ø 1.5 mm
- 28-622-20** Ø 2.0 mm
- 28-622-25** Ø 2.5 mm
- 28-622-30** Ø 3.0 mm
- 28-622-35** Ø 3.5 mm
- 28-622-40** Ø 4.0 mm
- 28-622-45** Ø 4.5 mm
- 28-622-50** Ø 5.0 mm
- 28-622-70** Ø 7.0 mm
- 28-622-90** Ø 9.0 mm



28-630-00

Garret Vascular Dilator

Set of 9 Ref: 28-632-10 to 28-632-50
 Overall Length 14 cm (5 ½")

- 28-632-10** Ø 1.0 mm
- 28-632-15** Ø 1.5 mm
- 28-632-20** Ø 2.0 mm
- 28-632-25** Ø 2.5 mm
- 28-632-30** Ø 3.0 mm
- 28-632-35** Ø 3.5 mm
- 28-632-40** Ø 4.0 mm
- 28-632-45** Ø 4.5 mm
- 28-632-50** Ø 5.0 mm



28-640-00

Garret Vascular Dilator

Set of 9 Ref: 28-642-00 to 28-642-50
 Overall Length 22 cm (8 ¾")

- 28-642-10** Ø 1.0 mm
- 28-642-15** Ø 1.5 mm
- 28-642-20** Ø 2.0 mm
- 28-642-25** Ø 2.5 mm
- 28-642-30** Ø 3.0 mm
- 28-642-35** Ø 3.5 mm
- 28-642-40** Ø 4.0 mm
- 28-642-45** Ø 4.5 mm
- 28-642-50** Ø 5.0 mm



Vascular Dilators
Gefäßdilatoren
Dilatadores vasculares
Dilateurs vasculaires
Dilatatori vascolari

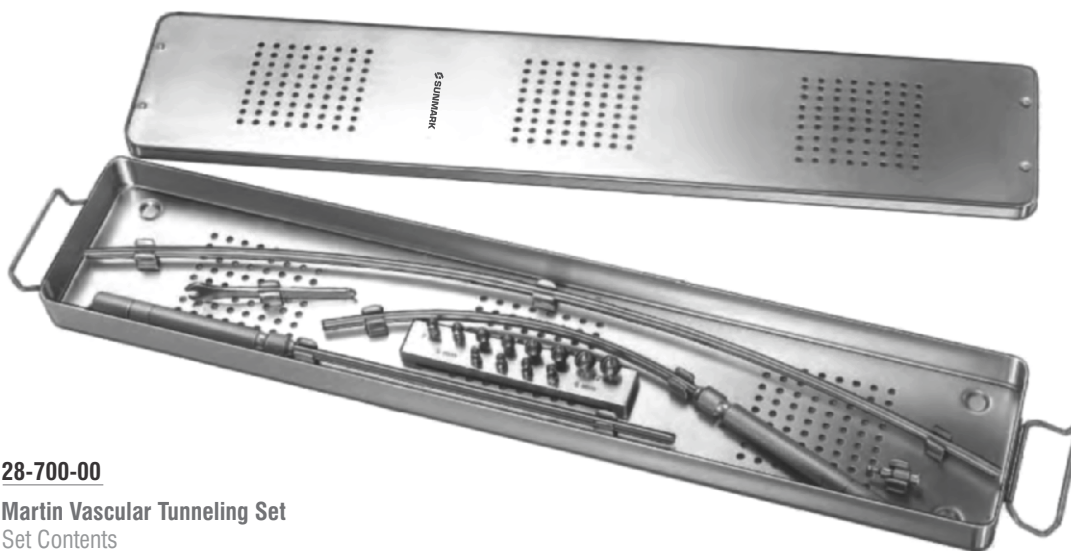

28-700-00

Martin Vascular Tunneling Set

Set Contents

- 1 - Handle for Tunneling Set
- 2 - Tunneling Shafts x 3
- 3 - Tunneling Tip x 4 (6 mm, 8 mm, 10 mm, 12 mm)
- 4 - Vein Tip x 1
- 5 - Luer Adapter
- 6 - Storage Case Stainless

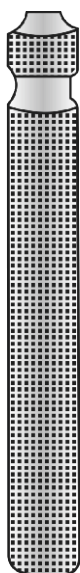

28-702-01

Universal Handle for Martin Tunneling Set

Overall Length 12.5 cm (5")

Tunneling Shaft
Gefäßdilatoren
Dilatadores vasculares
Dilatateurs vasculaires
Dilatatori vascolari



Tunneling Shaft

28-702-05
24.5 cm (9 3/4")

28-702-06
24.5 cm (9 3/4")

28-702-06
55.5 cm (21 3/4")



Screw Olive Tip
Gefäßdilatoren
Dilatadores vasculares
Dilateurs vasculaires
Dilatatori vascolari

THORAX, CARDIOVASCULAR SURGERY

Screw Olive Tip

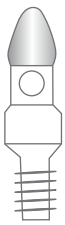

28-702-55
Ø 5.0 mm

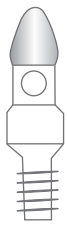

28-702-56
Ø 6.0 mm



28-702-57
Ø 7.0 mm



28-702-58
Ø 8.0 mm

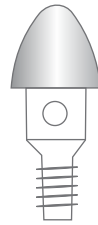

28-702-60
Ø 10.0 mm

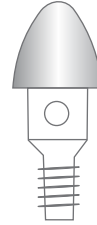

28-702-62
Ø 12.0 mm



Vein Tip
28-702-65
Standard



Luer Adapter
28-702-70
Standard



Fasciotomy Knife
Fasziotomiemesser
Cuchillo para fasciotomía
Couteau pour fasciotomie
Bisturi per fasziotomia

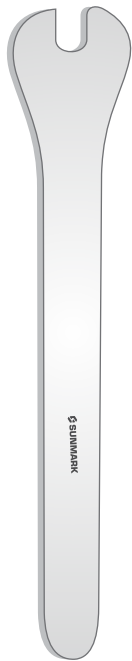

28-702-99
Wrench
Overall Length 10 cm (4")



28-720-00
Ross Ventricular Vent
Bullet Shaped
Set of 3
Ø 5.0, Ø 6.5, Ø 7.5 mm

28-720-01
Bullet Shaped
Small, Ø 5.0

28-720-02
Bullet Shaped
Small, Ø 6.5

28-720-03
Bullet Shaped
Small, Ø 7.5



28-751-01
Hach Fasciotomy Knife
Ferozcell Handle

Fasciotomy Spatulas
Fasziotomiespatel
Espátulas para fasciotomía
Spatule pour fasciotomie
Spatole per fasziotomia

THORAX, CARDIOVASCULAR SURGERY

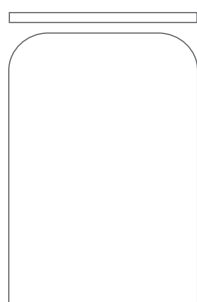

28-756-25
25 mm



28-756-32
32 mm

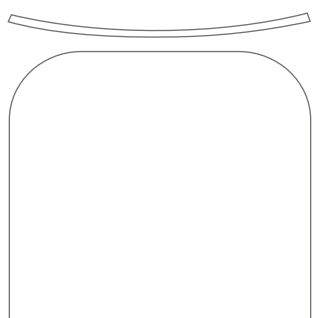

28-756-40
40 mm

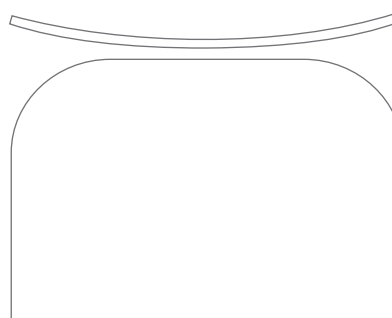

28-756-52
52 mm

Hach Fasciotomy Spatula
Overall Length 30 cm (11 3/4")



Intima Spatulas
Intimaspatel
Espátulas para la íntima
Spatules pour la tunique interne
Spatole per intima



28-759-01
Slightly Curved
28-759-02
Medium Curved
28-759-03
Strongly Curved
Lemmon Intima Spatula
Overall Length 16 cm (6 1/2")



28-771-18
Blunt
18.5 cm (7 1/4")
Intima Spatula

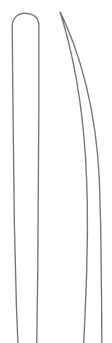

28-771-21
Blunt
21.5 cm (8 1/2")



28-773-14
Blunt
14 cm (5 1/2")
Intima Spatula



28-773-24
Blunt
23.5 cm (9 1/4")

Vascular Dissectors
Gefäßdissektoren
Disecadores vasculares
Dissecteurs vasculaires
Dissettori vascolari



28-775-01

Fig. 1
5 mm, Ø 2.5 mm

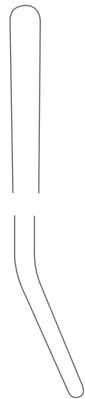

28-775-02

Fig. 2
4 mm, Ø 2 mm



28-775-03

Fig. 3
3 mm, Ø 1.5 mm



28-775-04

Fig. 4
2 mm, Ø 1.0 mm

Robb Vascular Dissector

Overall Length 24 cm (9 1/2")



Tourniquets
Tourniquets
Tourniquetes
Tourniquets
Tornichetti

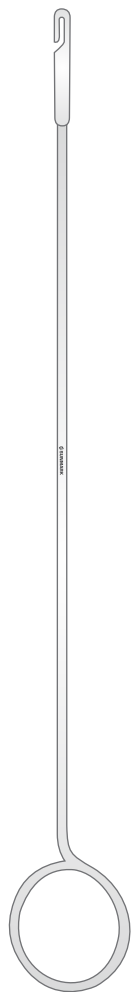

Ligature Catcher
Overall Length 26 cm (10 1/4")

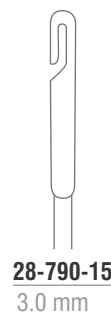
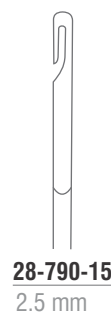
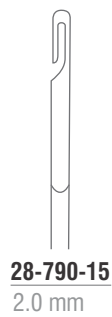
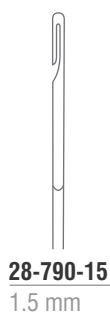

28-794-27
Rumel-Belmont Tourniquet
Ø 3.2 mm
Overall Length 27 cm (10 3/4")

28-796-30
Ø 6.4 mm
Overall Length 30.5 cm (12")

Operating Scissors
Chirurgische Scheren
Tijeras quirúrgicas
Ciseaux chirurgicaux
Forbici per chirurgia



Operating Scissors
Straight, Blunt/Blunt

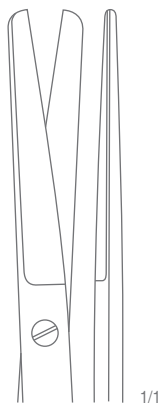

77-002-11
12 cm (4 3/4")

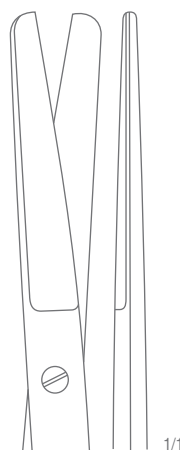

77-002-13
13 cm (5")

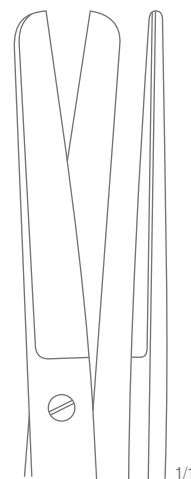

77-002-14
14.5 cm (5 3/4")

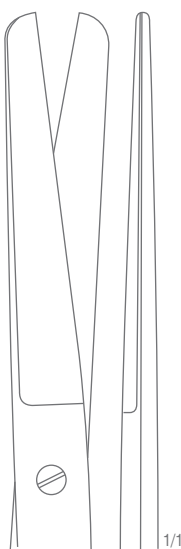

77-002-16
16.5 cm (6 1/2")

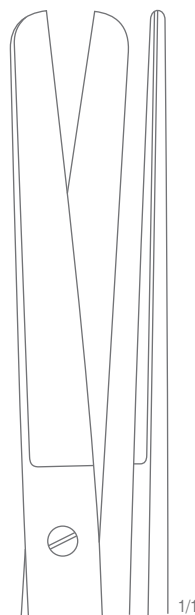

77-002-18
18.5 cm (7 1/4")

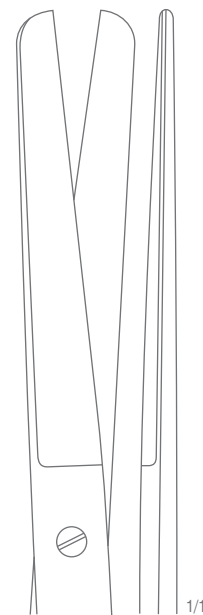

77-002-20
20.5 cm (8")

Operating Scissors
Chirurgische Scheren
Tijeras quirúrgicas
Ciseaux chirurgicaux
Forbici per chirurgia



Operating Scissors
Curved, Blunt/Blunt



77-003-11
12 cm (4 3/4")

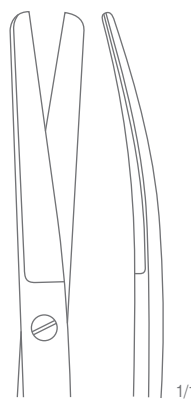

77-003-13
13 cm (5")

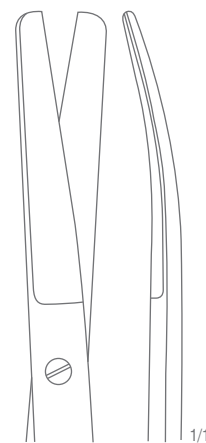

77-003-14
14.5 cm (5 3/4")



77-003-16
16.5 cm (6 1/2")



77-003-18
18.5 cm (7 1/4")



77-003-20
20.5 cm (8")

Operating Scissors
 Chirurgische Scheren
 Tijeras quirúrgicas
 Ciseaux chirurgicaux
 Forbici per chirurgia



Operating Scissors
 Straight, Sharp/Blunt



77-004-11
 12 cm (4 3/4")

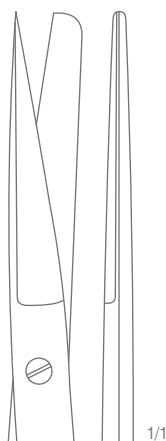

77-004-13
 13 cm (5")

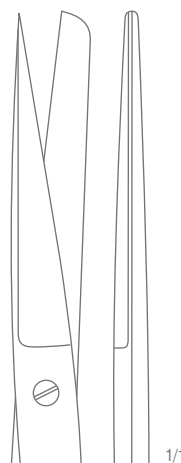

77-004-14
 14.5 cm (5 3/4")

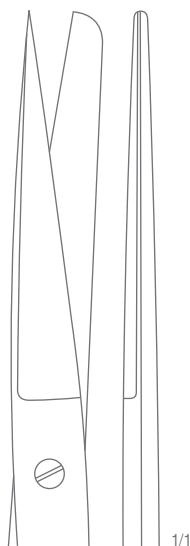

77-004-16
 16.5 cm (6 1/2")



77-004-18
 18.5 cm (7 1/4")

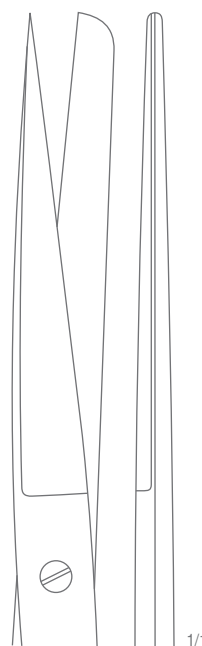

77-004-20
 20.5 cm (8")

Operating Scissors
Chirurgische Scheren
Tijeras quirúrgicas
Ciseaux chirurgicaux
Forbici per chirurgia

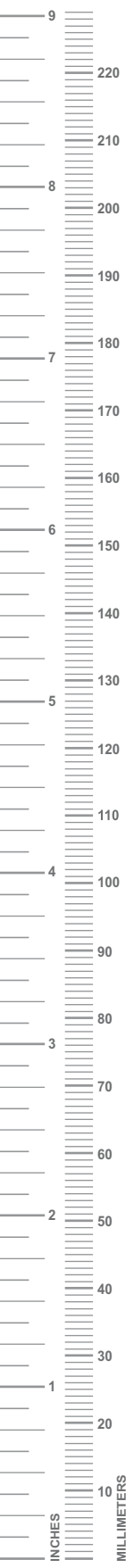

SUPEREdge™

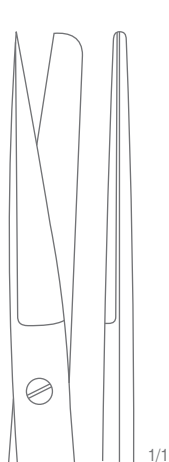

77-004-13 SC
13 cm (5")

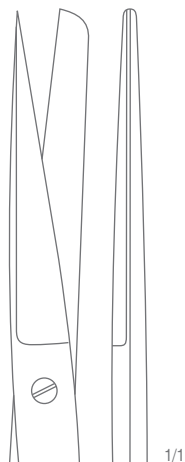

77-004-14 SC
14.5 cm (5 3/4")

Operating Scissors
Straight, Sharp/Blunt

Operating Scissors
Chirurgische Scheren
Tijeras quirúrgicas
Ciseaux chirurgicaux
Forbici per chirurgia



Operating Scissors
Curved, Sharp/Blunt

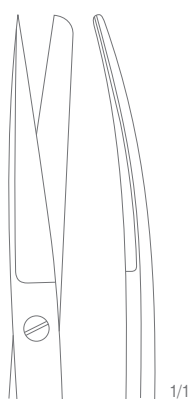

77-005-11
12 cm (4 3/4")

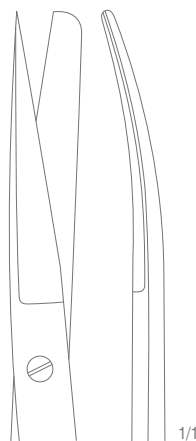

77-005-13
13 cm (5")



77-005-14
14.5 cm (5 3/4")



77-005-16
16.5 cm (6 1/2")



77-005-18
18.5 cm (7 1/4")



77-005-20
20.5 cm (8")

Operating Scissors
Chirurgische Scheren
Tijeras quirúrgicas
Ciseaux chirurgicaux
Forbici per chirurgia



Operating Scissors
Curved, Sharp/Blunt

SUPER*Edge*TM

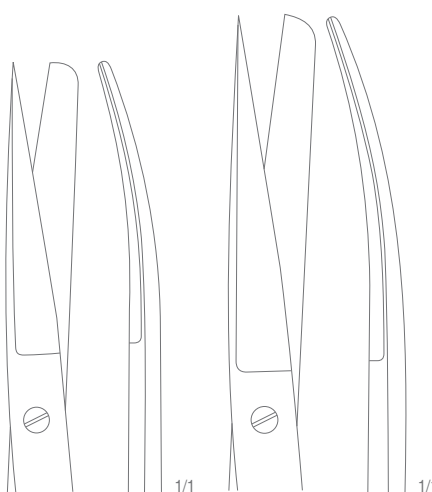

77-005-13 SC
13 cm (5")

77-005-14 SC
14.5 cm (5 3/4")

Operating Scissors
 Chirurgische Scheren
 Tijeras quirúrgicas
 Ciseaux chirurgicaux
 Forbici per chirurgia

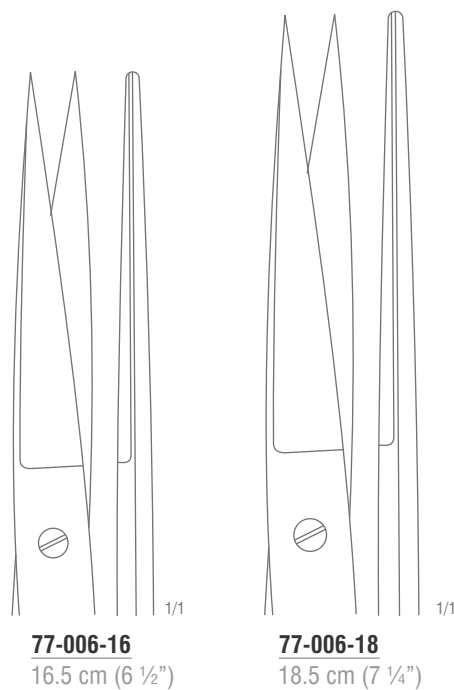
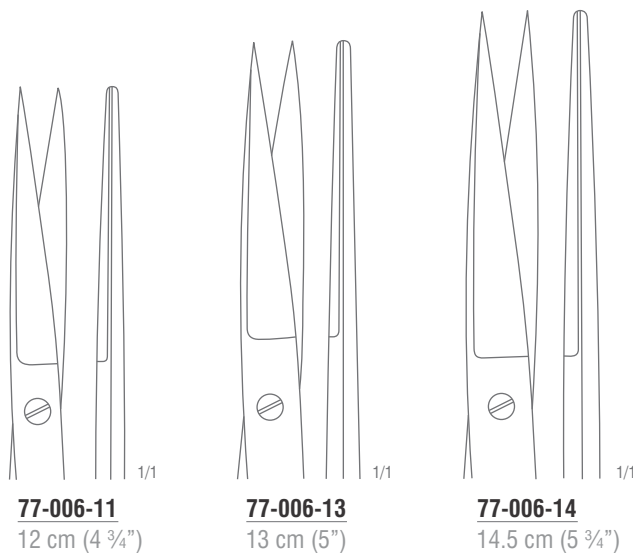

Operating Scissors
 Straight, Sharp/Sharp



Operating Scissors
Chirurgische Scheren
Tijeras quirúrgicas
Ciseaux chirurgicaux
Forbici per chirurgia

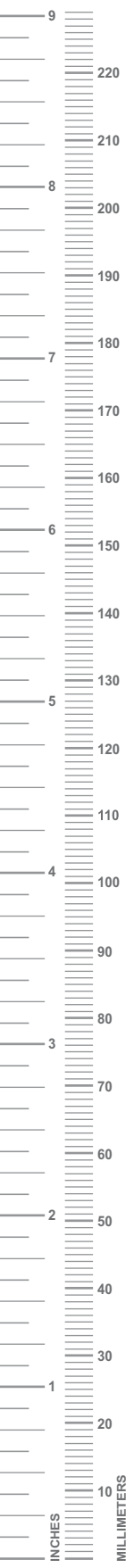

Operating Scissors
Curved, Sharp/Sharp

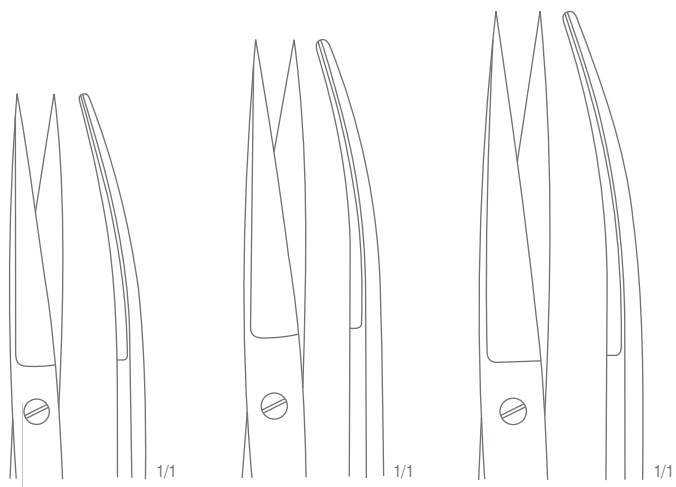

77-007-11
12 cm (4 3/4")

77-007-13
13 cm (5")

77-007-14
14.5 cm (5 3/4")

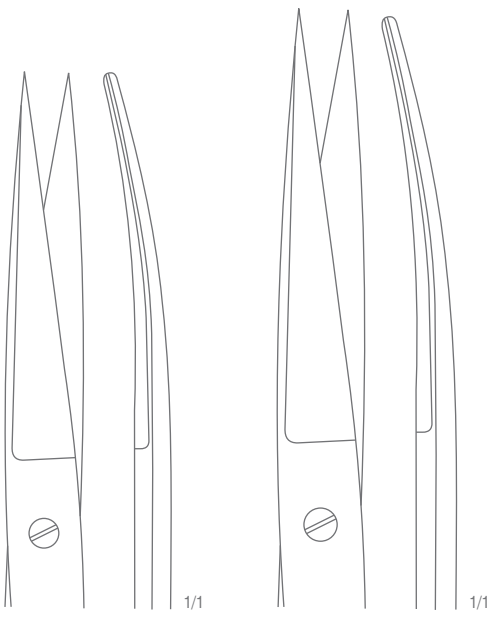

77-007-16
16.5 cm (6 1/2")

77-007-18
18.5 cm (7 1/4")

Operating Scissors
Chirurgische Scheren
Tijeras quirúrgicas
Ciseaux chirurgicaux
Forbici per chirurgia

77

THORAX, CARDIOVASCULAR SURGERY



Operating Scissors
Blunt/Blunt

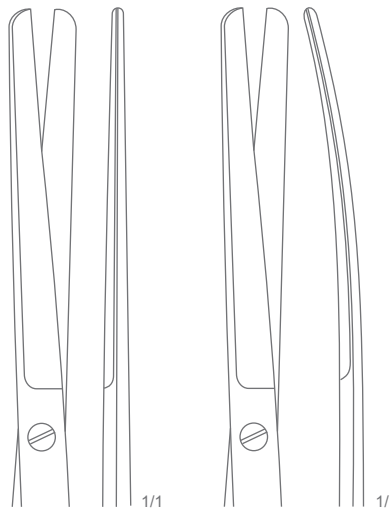

77-010-14
14.5 cm (5 3/4")
Straight

77-011-14
14.5 cm (5 3/4")
Curved

Operating Scissors
Chirurgische Scheren
Tijeras quirúrgicas
Ciseaux chirurgicaux
Forbici per chirurgia

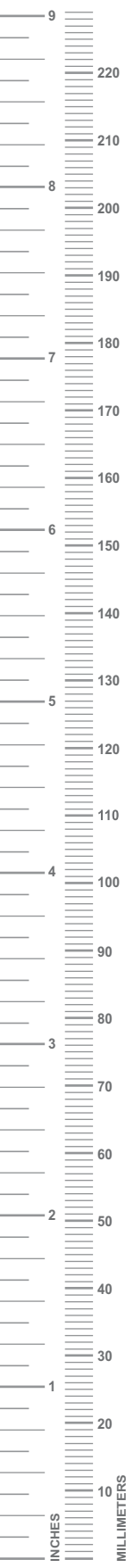

Operating Scissors
Straight, Sharp/Blunt

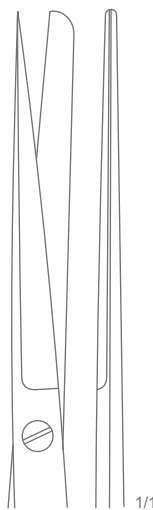

77-012-14
14.5 cm (5 3/4")
Straight



77-013-14
14.5 cm (5 3/4")
Curved

Operating Scissors
Chirurgische Scheren
Tijeras quirúrgicas
Ciseaux chirurgicaux
Forbici per chirurgia

77

THORAX, CARDIOVASCULAR SURGERY

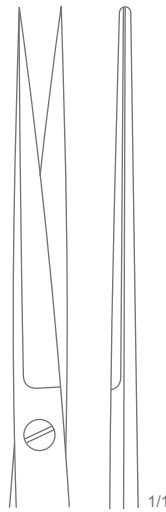

77-014-14
Straight
14.5 cm (5 3/4")



77-015-14
Curved
14.5 cm (5 3/4")

Operating Scissors
Straight, Sharp/Sharp

Operating Scissors
Chirurgische Scheren
Tijeras quirúrgicas
Ciseaux chirurgicaux
Forbici per chirurgia

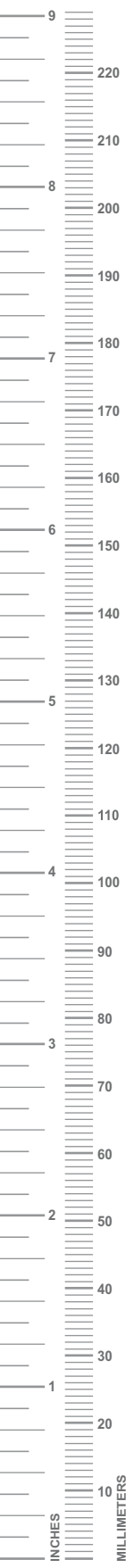

Deaver Operating Scissor
Sharp/Blunt

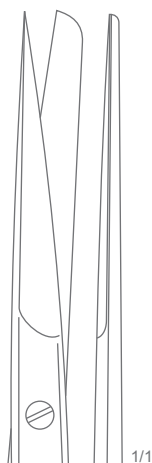

77-030-14
Straight
14 cm (5 1/2")



77-031-14
Curved
14 cm (5 1/2")

Operating Scissors
Chirurgische Scheren
Tijeras quirúrgicas
Ciseaux chirurgicaux
Forbici per chirurgia

77

THORAX, CARDIOVASCULAR SURGERY

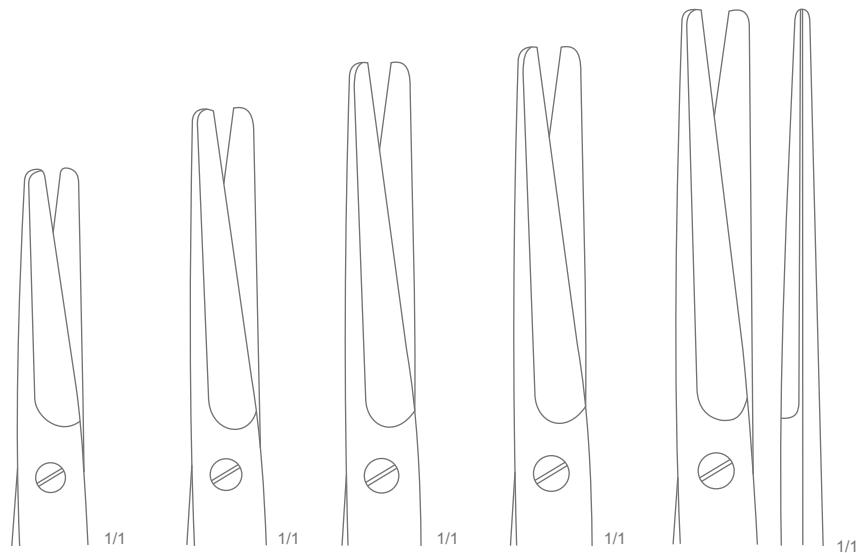

77-040-14
14.5 cm (5 ¾")

77-040-15
15 cm (6")

77-040-17
17 cm (6 ¾")

77-040-19
19 cm (7 ½")

77-040-23
23.5 cm (9 ¼")

Mayo Dissecting Scissor
Straight

Operating Scissors
Chirurgische Scheren
Tijeras quirúrgicas
Ciseaux chirurgicaux
Forbici per chirurgia



Mayo Dissecting Scissor
Straight

SUPER*Edge*TM

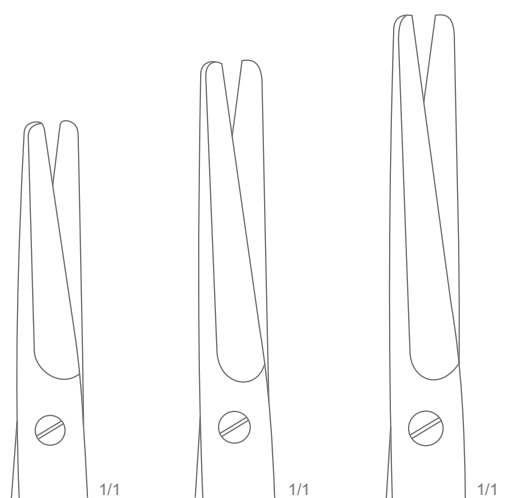

77-040-14 SC
14.5 cm (5 3/4")

77-040-15 SC
15 cm (6")

77-040-17 SC
17 cm (6 3/4")

Operating Scissors
Chirurgische Scheren
Tijeras quirúrgicas
Ciseaux chirurgicaux
Forbici per chirurgia

THORAX, CARDIOVASCULAR SURGERY



Mayo Dissecting Scissor
Curved

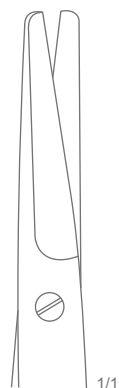

77-041-14
14.5 cm (5 3/4")

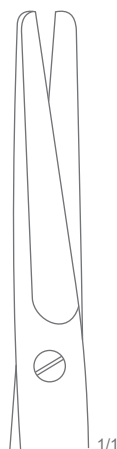

77-041-15
15 cm (6")

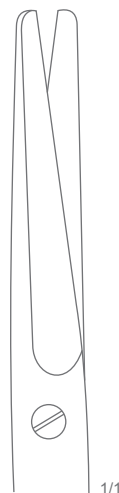

77-041-17
17 cm (6 3/4")

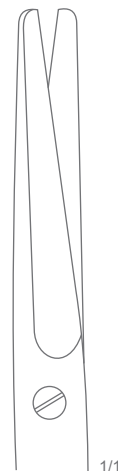

77-041-19
19 cm (7 1/2")



77-041-23
23.5 cm (9 1/4")



77-041-35
35.5 cm (14")

Operating Scissors
Chirurgische Scheren
Tijeras quirúrgicas
Ciseaux chirurgicaux
Forbici per chirurgia



Mayo Dissecting Scissor
Curved

SUPER*Edge*[™]



77-041-14
14.5 cm (5 3/4")

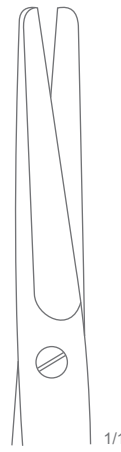

77-041-15
15 cm (6")

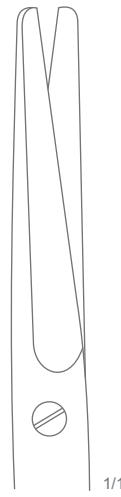

77-041-17
17 cm (6 3/4")



77-041-23
23.5 cm (9 1/4")



Dissecting Scissors
 Präparierscheren
 Tijeras de disección
 Ciseaux à dissection
 Forbici per dissezione

THORAX, CARDIOVASCULAR SURGERY



Mayo Dissecting Scissor
 With Chamfered Blades



77-042-19
 Straight
 19 cm (7 ½")

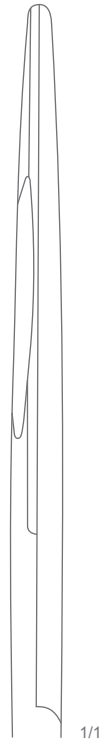

77-042-21
 Straight
 21.5 cm (8 ½")



77-043-19
 Curved
 19 cm (7 ½")

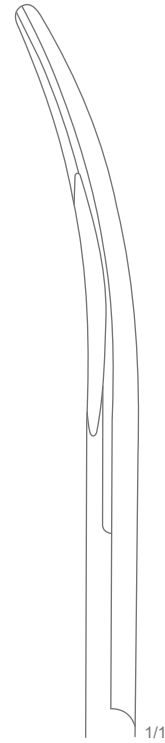

77-043-21
 Curved
 21.5 cm (8 ½")

Dissecting Scissors
Präparierscheren
Tijeras de disección
Ciseaux à dissection
Forbici per dissezione



77-046-23
Straight
23 cm (9")



77-047-23
Curved
22.5 cm (9")



77-047-28
Curved
28 cm (11")

Mayo-Harrington Dissecting Scissor



77-046-23 SC
Straight
23 cm (9")



77-047-23 SC
Curved
22.5 cm (9")

Mayo-Harrington Dissecting Scissor

Dissecting Scissors
Präparierscheren
Tijeras de disección
Ciseaux à dissection
Forbici per dissezione

THORAX, CARDIOVASCULAR SURGERY



Mayo-Stillie Dissecting Scissor

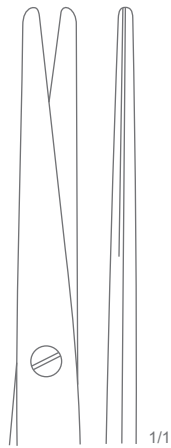

77-050-15
Straight
15 cm (6")

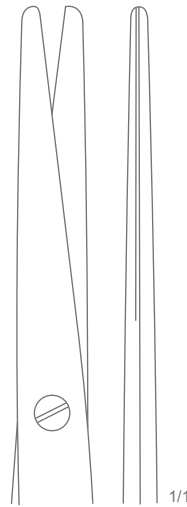

77-050-17
Straight
17 cm (6 3/4")



77-050-19
Straight
19.5 cm (7 3/4")

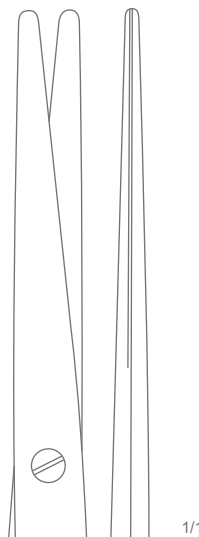

77-050-21
Straight
21.5 cm (8 1/2")

Dissecting Scissors
 Präparierscheren
 Tijeras de disección
 Ciseaux à dissection
 Forbici per dissezione



Mayo-Style Dissecting Scissor

SUPEREdge™

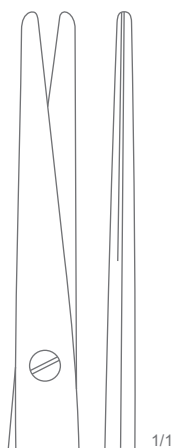

77-050-15 SC
 Straight
 15 cm (6")

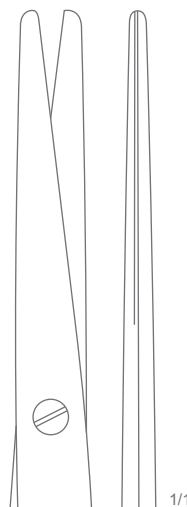

77-050-17 SC
 Straight
 17 cm (6 3/4")

Dissecting Scissors
Präparierscheren
Tijeras de disección
Ciseaux à dissection
Forbici per dissezione

THORAX, CARDIOVASCULAR SURGERY



Mayo-Stillie Dissecting Scissor



77-051-15
Curved
15 cm (6")



77-051-17
Curved
17 cm (6 ¾")



77-051-19
Curved
19.5 cm (7 ¾")



77-051-21
Curved
21.5 cm (8 ½")

Dissecting Scissors
 Präparierscheren
 Tijeras de disección
 Ciseaux à dissection
 Forbici per dissezione



Mayo-Style Dissecting Scissor

SUPER*Edge*[™]



77-051-15 SC
 Curved
 15 cm (6")



77-051-17 SC
 Curved
 17 cm (6 3/4")

Dissecting Scissors
Präparierscheren
Tijeras de disección
Ciseaux à dissection
Forbici per dissezione

77

THORAX, CARDIOVASCULAR SURGERY



Mayo-Style Dissecting Scissor
With Chamfered Blades



77-052-14
Straight
14 cm (5 1/2")

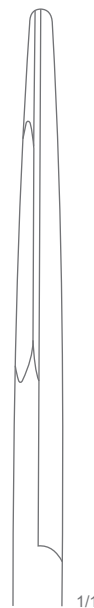

77-052-17
Straight
17 cm (6 3/4")



77-053-14
Curved
14 cm (5 1/2")



77-053-17
Curved
17 cm (6 3/4")

Dissecting Scissors
Präparierscheren
Tijeras de disección
Ciseaux à dissection
Forbici per dissezione



Stille Dissecting Scissor

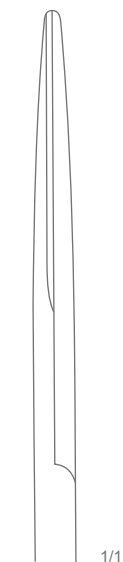

77-056-15
Straight
15 cm (6")

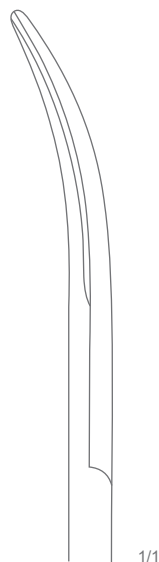

77-057-15
Curved
15 cm (6")



Mayo-Noble Gynecological Scissor



77-060-17
Straight
16.5 cm (6 1/2")



77-061-17
Curved
16.5 cm (6 1/2")

Dissecting Scissors
 Präparierscheren
 Tijeras de disección
 Ciseaux à dissection
 Forbici per dissezione

THORAX, CARDIOVASCULAR SURGERY



77-100-16
Straight

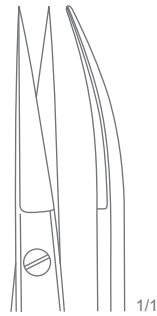

77-101-16
Curved

Kelly Dissecting Scissor
 Overall Length 16 cm (6 1/4")



77-100-16 SC
Straight

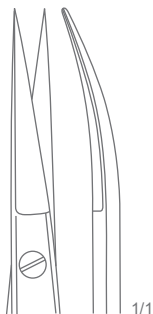

77-101-16 SC
Curved

Kelly Dissecting Scissor
 Overall Length 16 cm (6 1/4")

SUPER*Edge*[™]

Dissecting Scissors
Präparierscheren
Tijeras de disección
Ciseaux à dissection
Forbici per dissezione



Joseph Dissecting Scissor
Overall Length 15 cm (6")

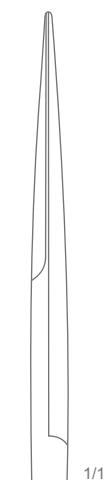

77-104-15
Straight

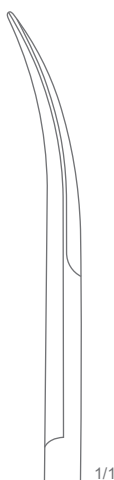

77-105-15
Curved



Joseph Dissecting Scissor
Overall Length 15 cm (6")

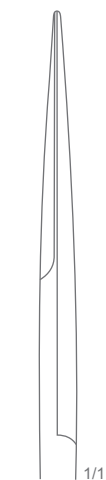

77-104-15 SC
Straight

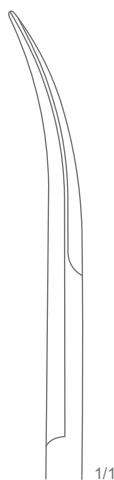

77-105-15 SC
Curved



Dissecting Scissors
 Präparierscheren
 Tijeras de disección
 Ciseaux à dissection
 Forbici per dissezione

THORAX, CARDIOVASCULAR SURGERY

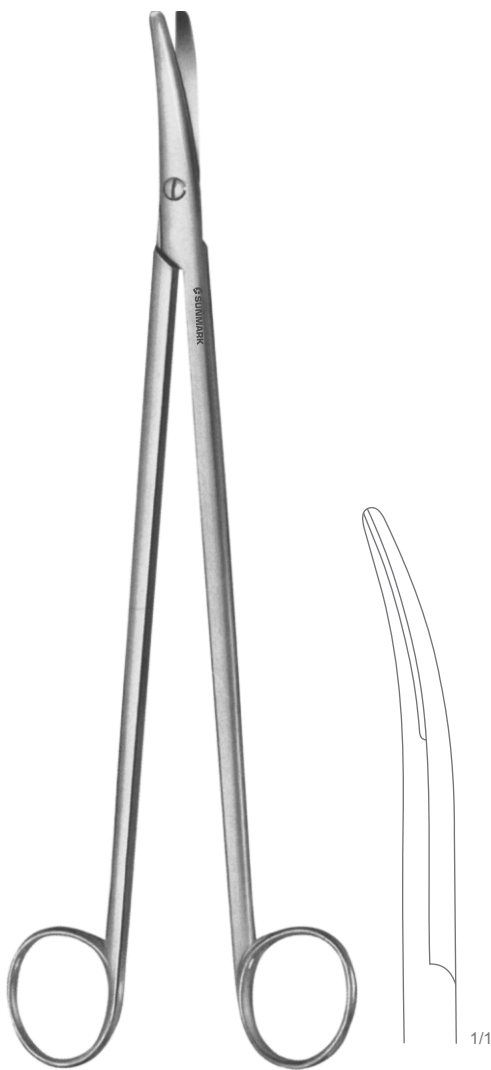

77-111-28
Weller Dissecting Scissor
 Heavy Pattern
 Overall Length 28 cm (11")



77-113-25
Resano Cartilage Scissor
 Overall Length 25 cm (9 3/4")

Dissecting Scissors
Präparierscheren
Tijeras de disección
Ciseaux à dissection
Forbici per dissezione



Metzenbaum Dissecting Scissor
Overall Length 11.5 cm (4 ½")

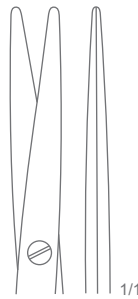

77-120-11
Straight
Blunt/Blunt

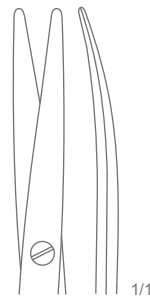

77-121-11
Curved
Blunt/Blunt



Metzenbaum Dissecting Scissor
Overall Length 11.5 cm (4 ½")

SUPEREdge™

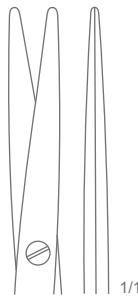

77-120-11 SC
Straight
Blunt/Blunt

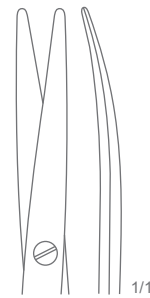

77-121-11 SC
Curved
Blunt/Blunt



Dissecting Scissors
Präparierscheren
Tijeras de disección
Ciseaux à dissection
Forbici per dissezione

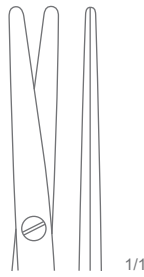
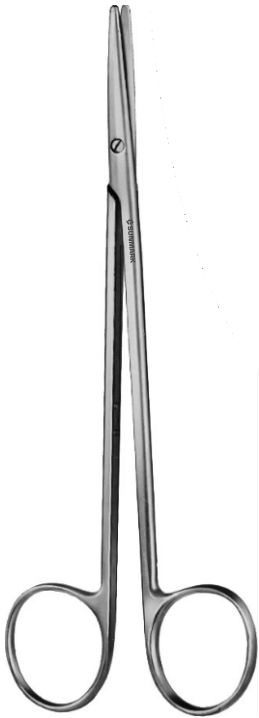

77-122-15
Straight
Blunt/Blunt

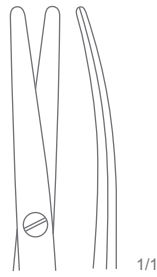

77-123-15
Curved
Blunt/Blunt

Metzenbaum Dissecting Scissor
Overall Length 15.5 cm (6")

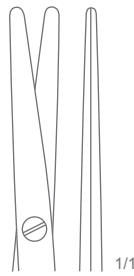
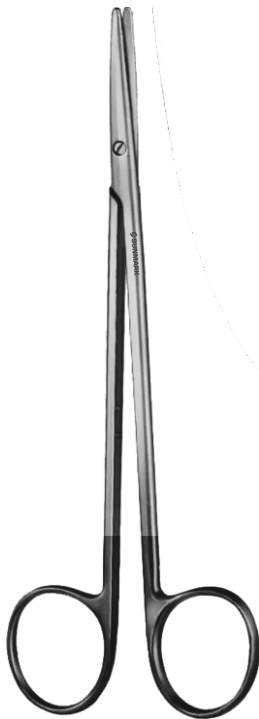

77-122-15 SC
Straight
Blunt/Blunt



77-123-15 SC
Curved
Blunt/Blunt

Metzenbaum Dissecting Scissor
Overall Length 15.5 cm (6")

SUPEREdge™

THORAX, CARDIOVASCULAR SURGERY

Dissecting Scissors
Präparierscheren
Tijeras de disección
Ciseaux à dissection
Forbici per dissezione

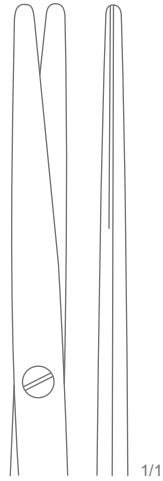

77-130-14
Straight
Blunt/Blunt



77-131-14
Curved
Blunt/Blunt

Metzenbaum Dissecting Scissor
Overall Length 14.5 cm (5 3/4")

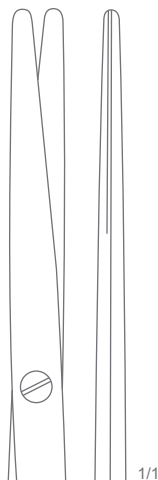

77-130-14 SC
Straight
Blunt/Blunt



77-131-14 SC
Curved
Blunt/Blunt

Metzenbaum Dissecting Scissor
Overall Length 14.5 cm (5 3/4")

SUPEREdge™

Dissecting Scissors
 Präparierscheren
 Tijeras de disección
 Ciseaux à dissection
 Forbici per dissezione



Metzenbaum Dissecting Scissor
 Overall Length 14.5 cm (5 ¾")



Metzenbaum Dissecting Scissor
 Overall Length 14.5 cm (5 ¾")

Dissecting Scissors
Präparierscheren
Tijeras de disección
Ciseaux à dissection
Forbici per dissezione



Metzenbaum-Nelson Dissecting Scissor
Straight, Blunt/Blunt

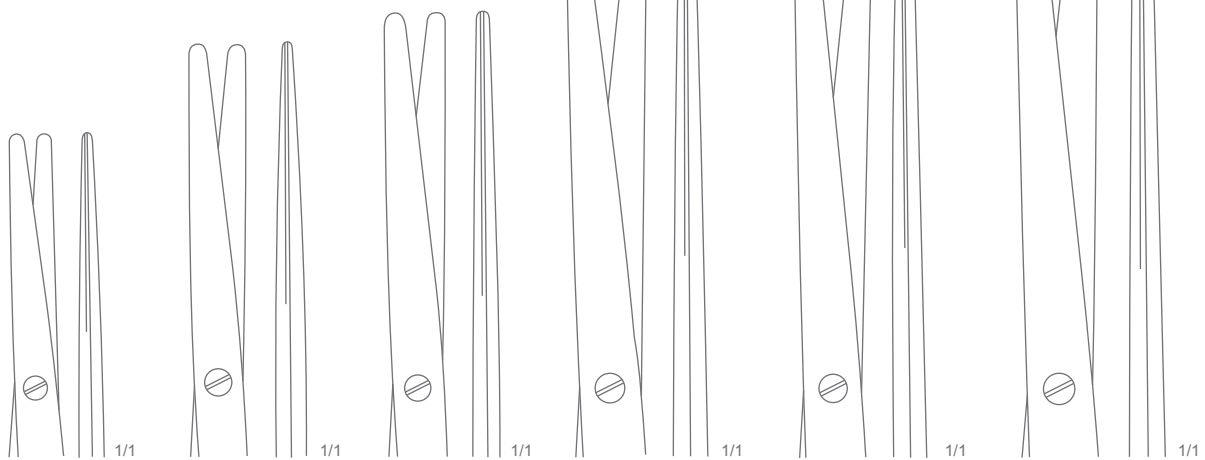

77-140-18
18 cm (7")

77-140-20
20.5 cm (8")

77-140-23
23 cm (9")

77-140-26
26 cm (10 1/4")

77-140-28
28.5 cm (11 1/4")

77-140-30
31 cm (12 1/4")

INCHES
MILLIMETERS

Dissecting Scissors
 Präparierscheren
 Tijeras de disección
 Ciseaux à dissection
 Forbici per dissezione

THORAX, CARDIOVASCULAR SURGERY

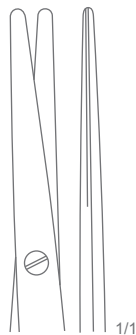

77-140-18 SC
18 cm (7")

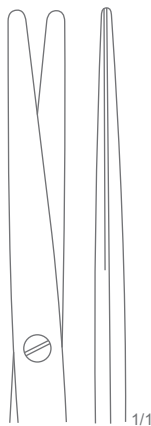

77-140-20 SC
20.5 cm (8")

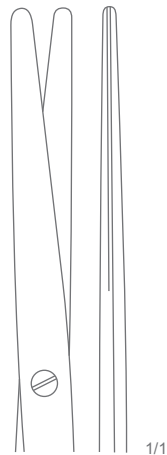

77-140-23 SC
23 cm (9")

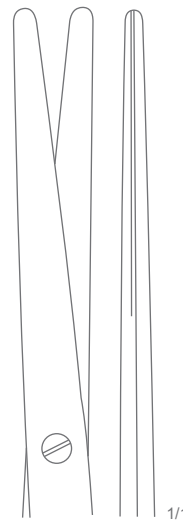

77-140-26 SC
26 cm (10 1/4")

Metzenbaum-Nelson Dissecting Scissor
 Straight, Blunt/Blunt

SUPEREdge™



Dissecting Scissors
 Präparierscheren
 Tijeras de disección
 Ciseaux à dissection
 Forbici per dissezione



Metzenbaum-Nelson Dissecting Scissor
 Curved, Blunt/Blunt



77-141-18
 18 cm (7")

77-141-20
 20.5 cm (8")

77-141-23
 23 cm (9")

77-141-26
 26 cm (10 1/4")

77-141-28
 28.5 cm (11 1/4")

77-141-30
 31 cm (12 1/4")



Dissecting Scissors
 Präparierscheren
 Tijeras de disección
 Ciseaux à dissection
 Forbici per dissezione



77-141-18 SC
18 cm (7")



77-141-20 SC
20.5 cm (8")



77-141-23 SC
23 cm (9")



77-141-26 SC
26 cm (10 1/4")

Metzenbaum-Nelson Dissecting Scissor
 Curved, Blunt/Blunt

SUPEREdge™



Dissecting Scissors
 Präparierscheren
 Tijeras de disección
 Ciseaux à dissection
 Forbici per dissezione



77-142-18

Metzenbaum-Nelson Dissecting Scissor

Straight, Sharp/Blunt
 Overall Length 18 cm (7")

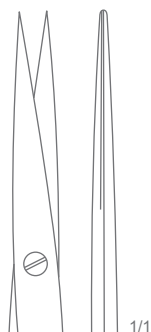

77-144-18
18 cm (7")

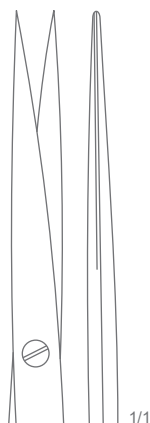

77-144-20
20.5 cm (8")

Metzenbaum-Nelson Dissecting Scissor

Straight, Sharp/Sharp

Dissecting Scissors
 Präparierscheren
 Tijeras de disección
 Ciseaux à dissection
 Forbici per dissezione

77-145-18

77-145-20

Metzenbaum-Nelson Dissecting Scissor

Curved, Sharp/Sharp
 Overall Length 18 cm (7")

77-145-18 SC

Metzenbaum-Nelson Dissecting Scissor

Curved, Sharp/Sharp
 Overall Length 18 cm (7")

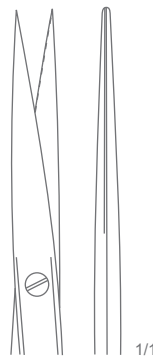

77-146-14



77-147-14

Metzenbaum Dissecting Scissor

Straight, Sharp/Sharp, Toothed
 Overall Length 14.5 cm (5 3/4")



Dissecting Scissors
Präparierscheren
Tijeras de disección
Ciseaux à dissection
Forbici per dissezione

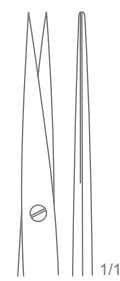
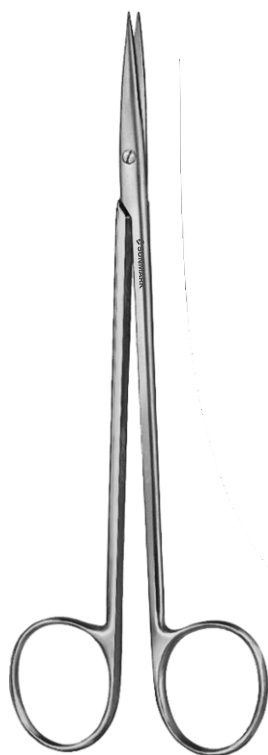

77-148-15
Straight



77-149-15
Curved

Metzenbaum Nerve Dissecting Scissor
Overall Length 15.5 cm (6")

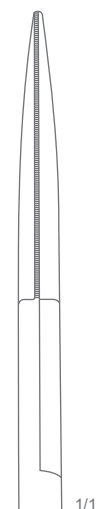

77-154-18
Straight
Toothed

Line Work

77-155-18
Curved
Toothed



77-157-18
Martin Cartilage Scissor
Curved
Overall Length 18.5 cm (7 1/4")

McIndoe Cartilage Scissor
Overall Length 18.5 cm (7 1/4")

Dissecting Scissors
Präparierscheren
Tijeras de disección
Ciseaux à dissection
Forbici per dissezione

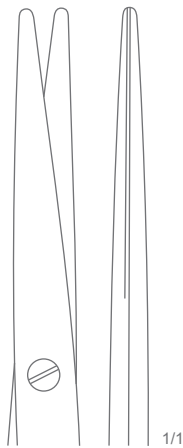

77-176-16
Straight



77-177-16
Curved

Aston Face-Lift Scissor
Overall Length 16 cm (6 1/4")



SUPER*Edge*[™]

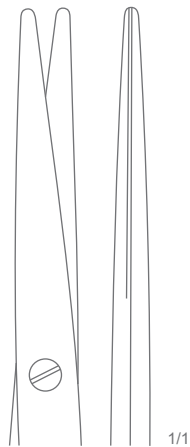

77-176-16 SC
Straight



77-177-16 SC
Curved

Aston Face-Lift Scissor
Overall Length 16 cm (6 1/4")

THORAX, CARDIOVASCULAR SURGERY

Dissecting Scissors
Präparierscheren
Tijeras de disección
Ciseaux à dissection
Forbici per dissezione

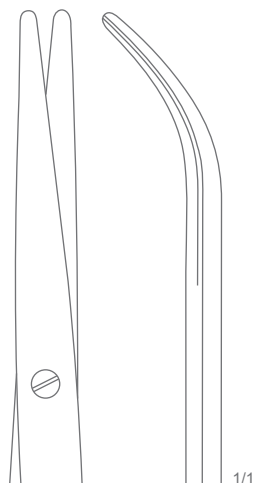

77-191-19
Thorek Dissecting Scissor
Curved
Overall Length 18.5 cm (7 1/4")

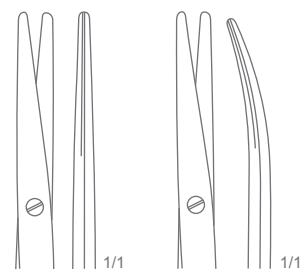

77-194-10
Straight

77-195-10
Curved

Lexer-Baby Dissecting Scissor
Overall Length 10 cm (4")

Dissecting Scissors
Präparierscheren
Tijeras de disección
Ciseaux à dissection
Forbici per dissezione

77

THORAX, CARDIOVASCULAR SURGERY

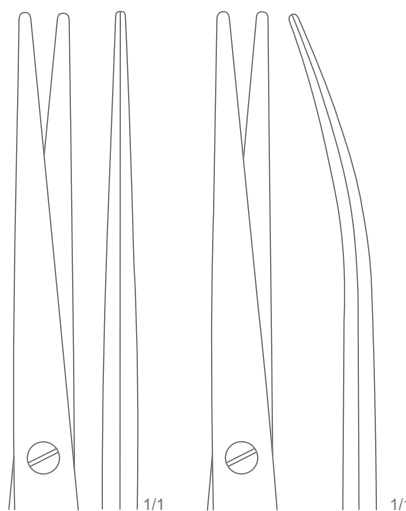

77-196-16
Straight
Slender Pattern

77-197-16
Curved
Slender Pattern

Lexer-Fine Delicate Dissecting Scissor
Overall Length 16.5 cm (6 1/2")

Dissecting Scissors
Präparierscheren
Tijeras de disección
Ciseaux à dissection
Forbici per dissezione

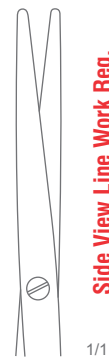

77-200-14
Straight

Side View Line Work Req.
Not found in KLS martin Cat.



77-201-14
Curved

Metzenbaum-Fine Delicate Dissecting Scissor
Blunt/Blunt, Slender Pattern
Overall Length 14.5 cm (5 3/4")



SUPEREdge™



77-200-14 SC
Straight

Side View Line Work Req.
Not found in KLS martin Cat.



77-201-14 SC
Curved

Metzenbaum-Fine Delicate Dissecting Scissor
Blunt/Blunt, Slender Pattern
Overall Length 14.5 cm (5 3/4")

Dissecting Scissors
Präparierscheren
Tijeras de disección
Ciseaux à dissection
Forbici per dissezione

THORAX, CARDIOVASCULAR SURGERY



77-202-14
Straight

Side View Line Work Req.
Not found in KLS martin Cat.



77-203-14
Curved

Metzenbaum-Fine Delicate Dissecting Scissor
Sharp/Sharp, Slender Pattern
Overall Length 14.5 cm (5 3/4")

Dissecting Scissors
Präparierscheren
Tijeras de disección
Ciseaux à dissection
Forbici per dissezione

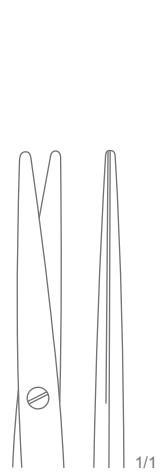

77-210-18
18 cm (7")

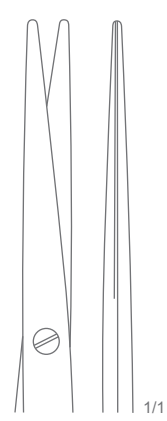

77-210-20
20 cm (8")

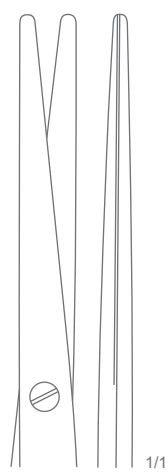

77-210-20
23 cm (9")

Metzenbaum-Fine Delicate Dissecting Scissor
Straight, Blunt/Blunt, Slender Pattern

SUPEREdge™

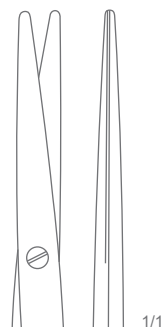

77-210-18 SC
18 cm (7")

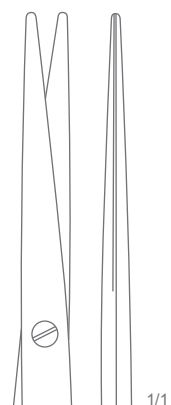

77-210-20 SC
20 cm (8")

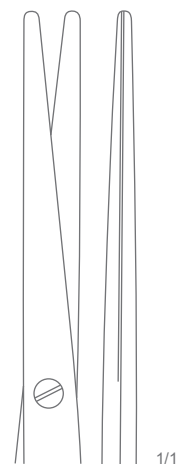

77-210-20 SC
23 cm (9")

Metzenbaum-Fine Delicate Dissecting Scissor
Straight, Blunt/Blunt, Slender Pattern

Dissecting Scissors
Präparierscheren
Tijeras de disección
Ciseaux à dissection
Forbici per dissezione

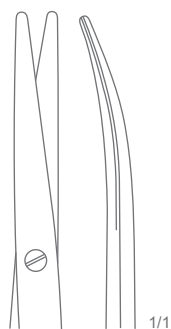

77-211-18
18 cm (7")



77-211-20
20 cm (8")



77-211-20
23 cm (9")

Metzenbaum-Fine Delicate Dissecting Scissor
Straight, Blunt/Blunt, Slender Pattern

SUPER*Edge*[™]

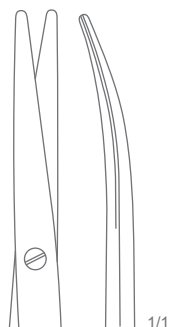

77-211-18 SC
18 cm (7")



77-211-20 SC
20 cm (8")

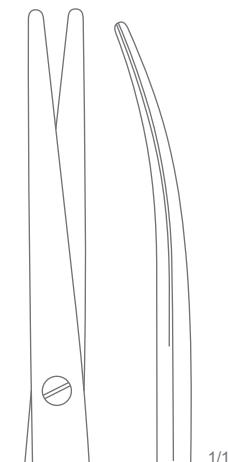

77-211-20 SC
23 cm (9")

Metzenbaum-Fine Delicate Dissecting Scissor
Straight, Blunt/Blunt, Slender Pattern

Dissecting Scissors
Präparierscheren
Tijeras de disección
Ciseaux à dissection
Forbici per dissezione



77-214-18
18 cm (7")

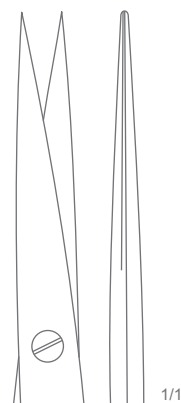

77-214-20
20 cm (8")

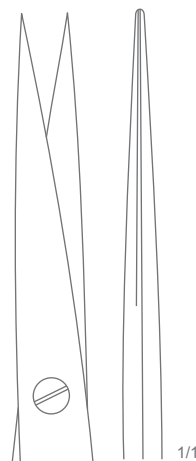

77-214-23
23 cm (9")

Metzenbaum-Fine Delicate Dissecting Scissor
Straight, Sharp/Sharp, Slender Pattern

SUPEREdge™

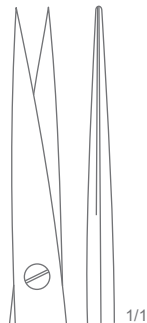

77-214-18 SC
18 cm (7")

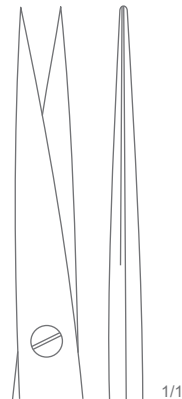

77-214-20 SC
20 cm (8")

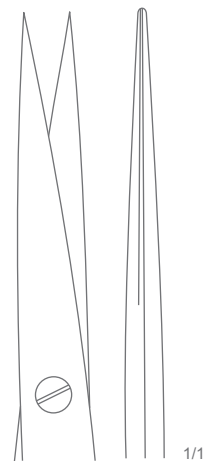

77-214-23 SC
23 cm (9")

Metzenbaum-Fine Delicate Dissecting Scissor
Straight, Sharp/Sharp, Slender Pattern



Dissecting Scissors
Präparierscheren
Tijeras de disección
Ciseaux à dissection
Forbici per dissezione



77-215-18
18 cm (7")



77-215-20
20 cm (8")



77-215-23
23 cm (9")

Metzenbaum-Fine Delicate Dissecting Scissor
Straight, Sharp/Sharp, Slender Pattern

SUPER*Edge*[™]



77-215-18 SC
18 cm (7")



77-215-20 SC
20 cm (8")



77-215-23 SC
23 cm (9")

Metzenbaum-Fine Delicate Dissecting Scissor
Straight, Sharp/Sharp, Slender Pattern

Dissecting Scissors
Präparierscheren
Tijeras de disección
Ciseaux à dissection
Forbici per dissezione

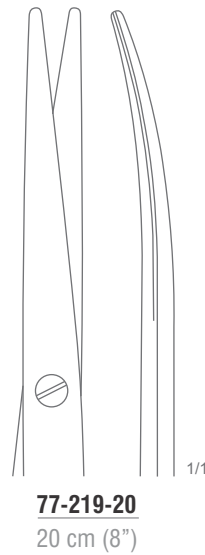
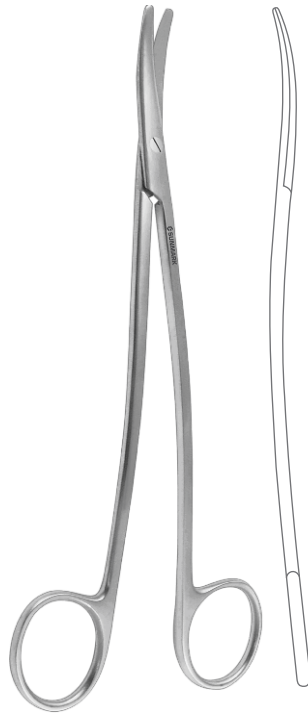

Metzenbaum-Fine Delicate Dissecting Scissor
Curved, S Shaped

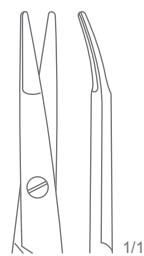

77-241-12
Shea Vein Graft Scissor
Curved
Overall Length 12 cm (4 3/4")

Dissecting Scissors
Präparierscheren
Tijeras de disección
Ciseaux à dissection
Forbici per dissezione

THORAX, CARDIOVASCULAR SURGERY

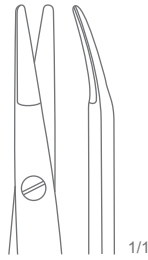

77-243-12
12 cm (4 ¾")



77-243-15
15 cm (6")

77-243-18
18 cm (7")

Ragnell (Kilner) Dissecting Scissor
Curved

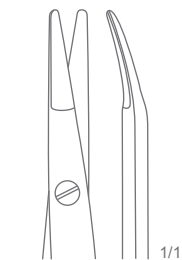

77-243-12 SC
12 cm (4 ¾")



77-243-15 SC
15 cm (6")

77-243-18 SC
18 cm (7")

Ragnell (Kilner) Dissecting Scissor
Curved

Dissecting Scissors
 Präparierscheren
 Tijeras de disección
 Ciseaux à dissection
 Forbici per dissezione



77-245-15
Nerve Dissecting Scissor
 Curved, Semi Sharp
 15 cm (6")

Dissecting Scissors
Präparierscheren
Tijeras de disección
Ciseaux à dissection
Forbici per dissezione

THORAX, CARDIOVASCULAR SURGERY

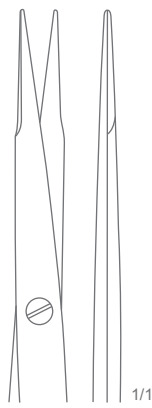
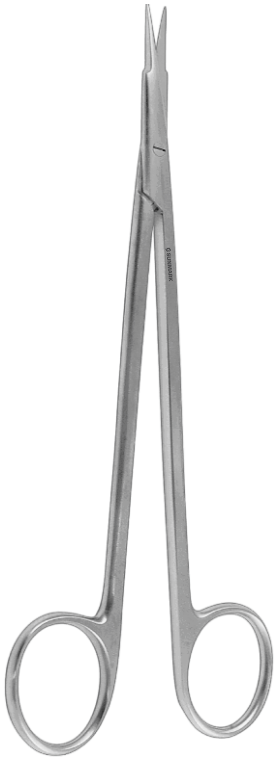

77-250-15
Straight
15.5 cm (6")

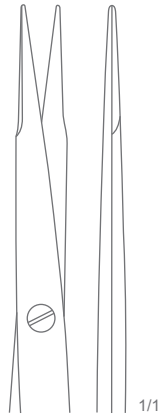

77-250-18
Straight
18 cm (7")



77-251-15
Curved
15.5 cm (6")



77-251-18
Curved
18 cm (7")

Reynolds Dissecting Scissor

SUPEREdge™

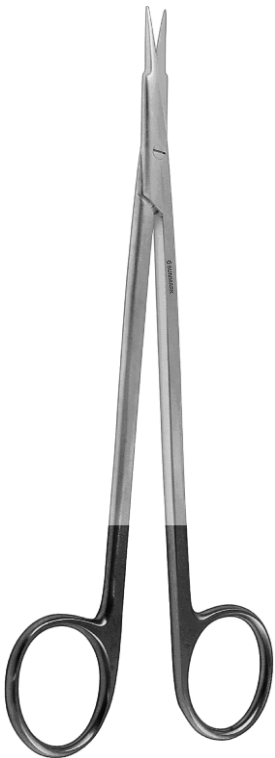

77-250-15 SC
Straight
15.5 cm (6")



77-250-18 SC
Straight
18 cm (7")



77-251-15 SC
Curved
15.5 cm (6")

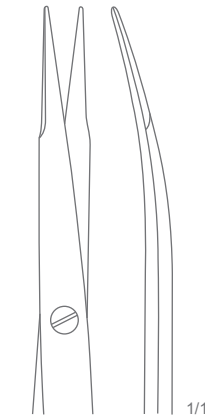

77-251-18 SC
Curved
18 cm (7")

Reynolds Dissecting Scissor

Dissecting Scissors
 Präparierscheren
 Tijeras de disección
 Ciseaux à dissection
 Forbici per dissezione

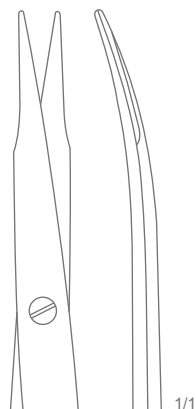
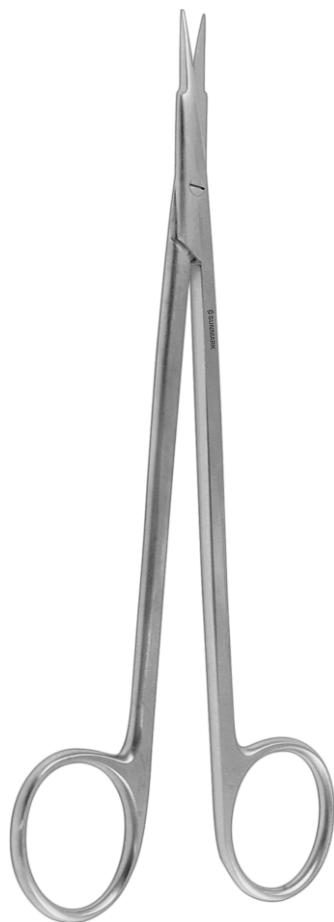

77-253-15
Jameson Dissecting Scissor
 Curved
 Overall Length 15.5 cm (6")

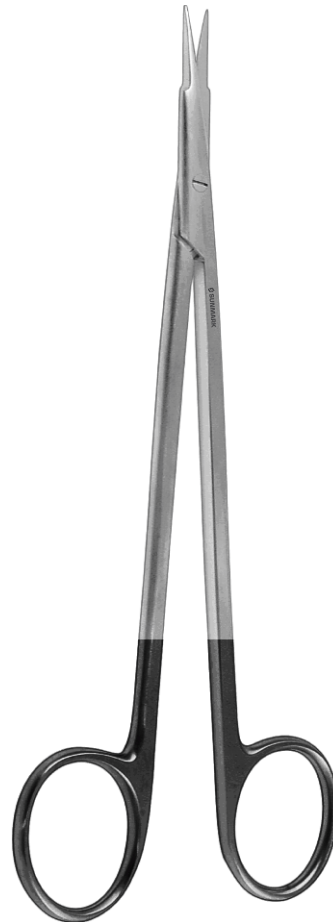

77-253-15 SC
Jameson Dissecting Scissor
 Curved
 Overall Length 15.5 cm (6")

SUPEREdge™

Dissecting Scissors
 Präparierscheren
 Tijeras de disección
 Ciseaux à dissection
 Forbici per dissezione

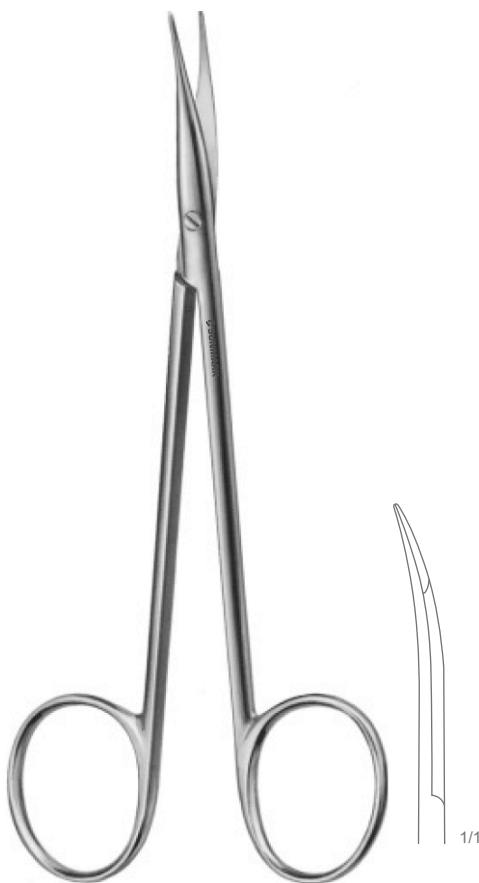

77-257-13
Jameson-Werber Dissecting Scissor
 Curved
 Overall Length 13 cm (5")



Potts Dissecting Scissor

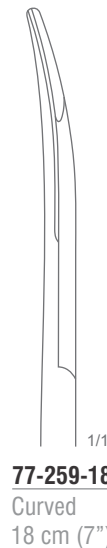

77-259-18
 Curved
 18 cm (7")

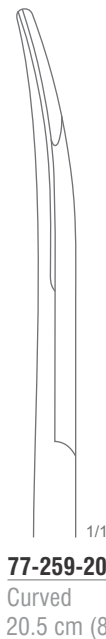

77-259-20
 Curved
 20.5 cm (8")

Vascular Scissors
 Gefäßscheren
 Tijeras vasculares
 Ciseaux vasculaires
 Forbici vascolari

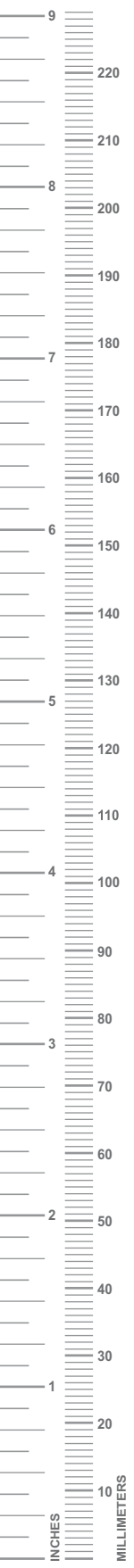

77-261-17
DeBakey Arteriotomy Scissor
 Curved
 Overall Length 17.5 cm (7")



DeBakey Arteriotomy Scissor
 Overall Length 19 cm (7 1/2")



77-264-19
 Straight



77-265-19
 Curved

Vascular Scissors
Gefäßscheren
Tijeras vasculares
Ciseaux vasculaires
Forbici vascolari

THORAX, CARDIOVASCULAR SURGERY

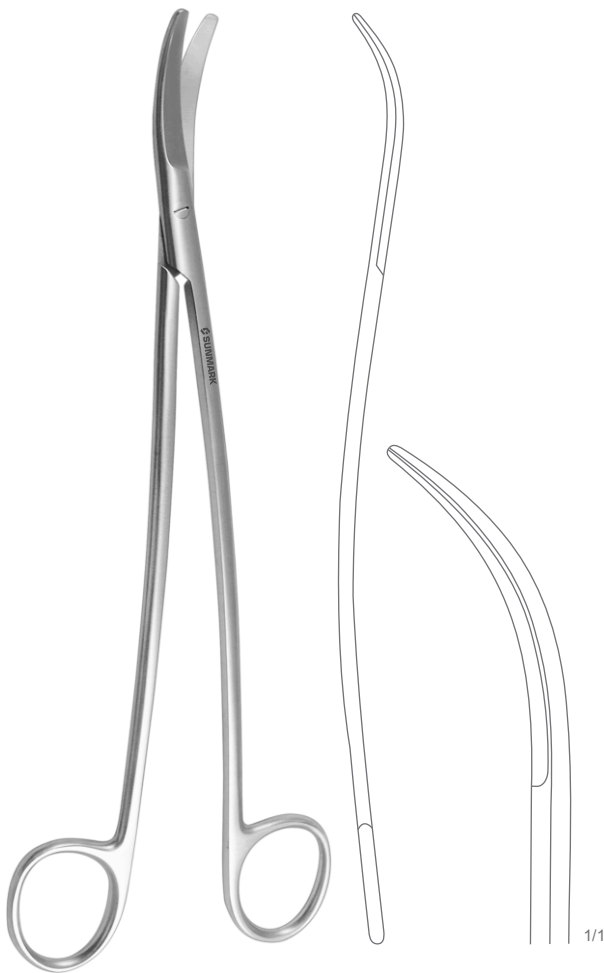

77-267-24
Satinsky Thoracic Scissor
Curved
Overall Length 25.5 cm (10")

77-267-25
Thomson Valve Scissor
Strongly Curved, With One Serrated Blade
Overall Length 25.5 cm (10")

Vascular Scissors
Gefäßscheren
Tijeras vasculares
Ciseaux vasculaires
Forbici vascolari

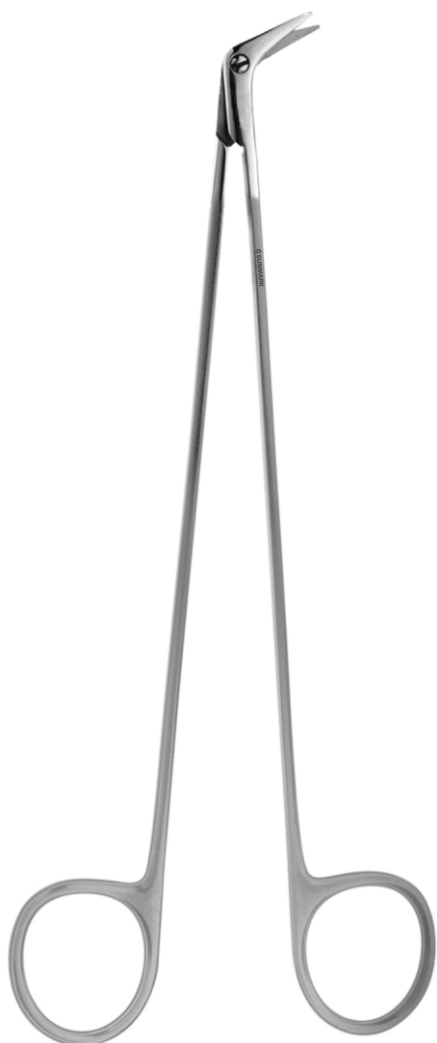

Peripheral Vascular Scissor
Overall Length 12.5 cm (5")

77-271-25
Peripheral Vascular Scissor
Angled 25°

77-271-45
Peripheral Vascular Scissor
Angled 45°

77-271-60
Peripheral Vascular Scissor
Angled 60°

77-271-90
Peripheral Vascular Scissor
Angled 90°

77-271-00
Peripheral Vascular Scissor
Angled 125°

Vascular Scissors
Gefäßscheren
Tijeras vasculares
Ciseaux vasculaires
Forbici vascolari

77

THORAX, CARDIOVASCULAR SURGERY

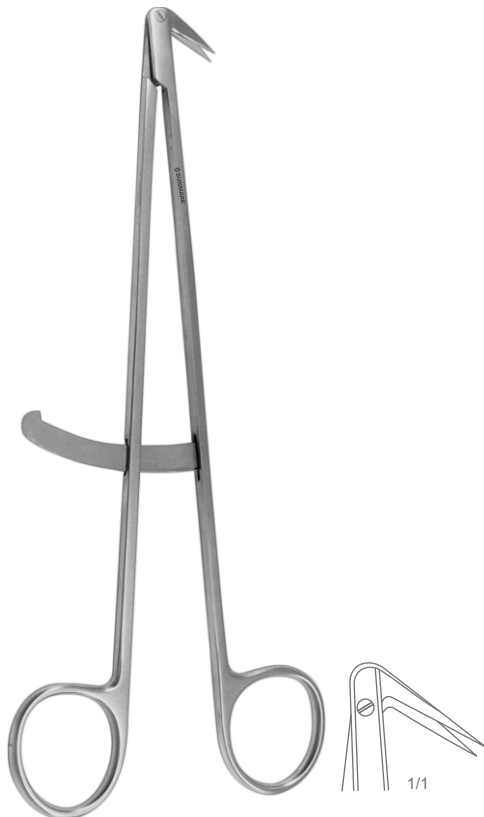

77-275-00
Diethrich Vascular Scissor
Angled, 125°, With Guide
Overall Length 17.5 cm (7")



DeBakey Vascular Scissor
Overall Length 16.5 cm (6 1/2")

77-277-45
Angled 45°

77-277-60
Angled 60°

Vascular Scissors
Gefäßscheren
Tijeras vasculares
Ciseaux vasculaires
Forbici vascolari

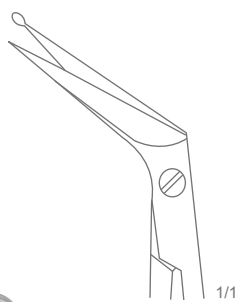
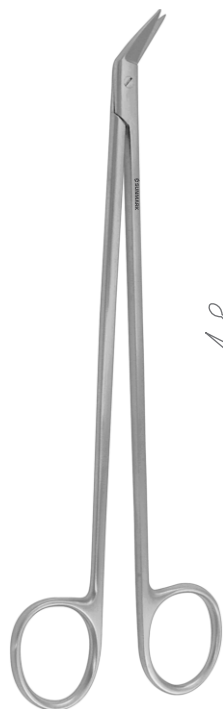

77-279-19
Angled 60°
With One Probe Tip

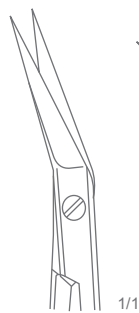

77-281-25
Angled 25°

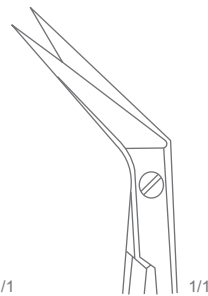

77-281-45
Angled 45°

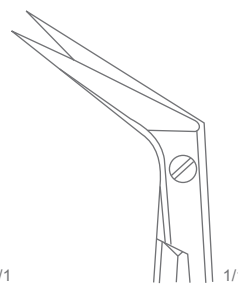

77-281-60
Angled 60°

Potts-Smith Vascular Scissor
Angled 60° With Probe Tip
Overall Length 18 cm (7")

SUPEREdge™

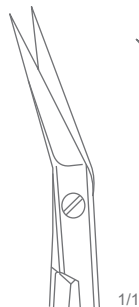
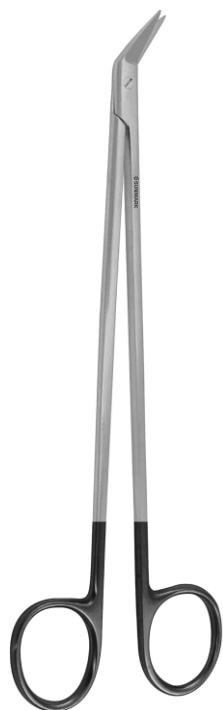

77-281-25 SC
Angled 25°

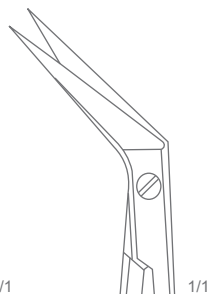

77-281-45 SC
Angled 45°

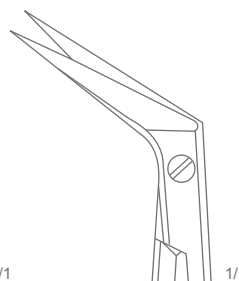

77-281-60 SC
Angled 60°

Potts-Smith Vascular Scissor
Overall Length 18 cm (7")

Vascular Scissors
Gefäßscheren
Tijeras vasculares
Ciseaux vasculaires
Forbici vascolari

THORAX, CARDIOVASCULAR SURGERY

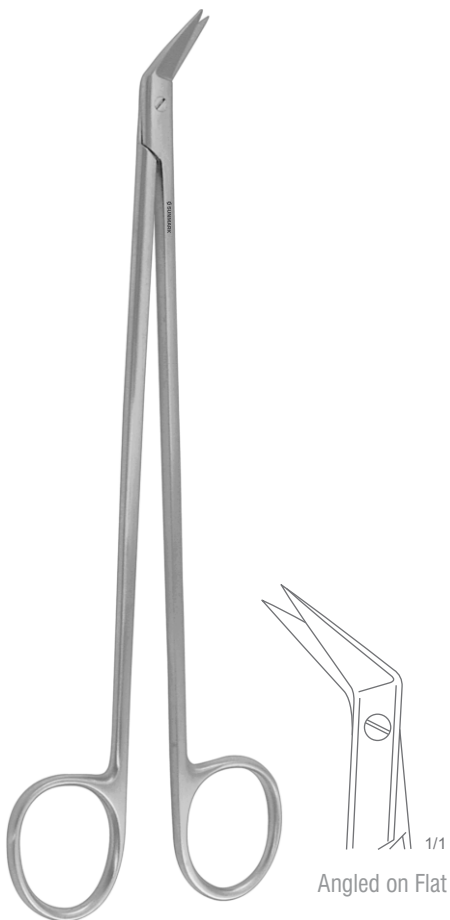

77-283-19
Potts-Smith Vascular Scissor
Angled 60°
Overall Length 18.5 cm (7 1/4")

Vascular Scissors
 Gefäßscheren
 Tijeras vasculares
 Ciseaux vasculaires
 Forbici vascolari

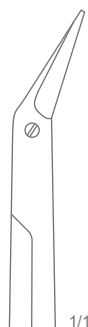

77-285-25
 Angled 25°

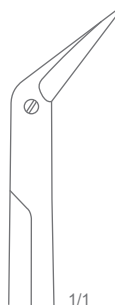

77-285-45
 Angled 45°

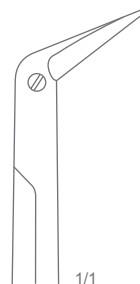

77-285-60
 Angled 60°

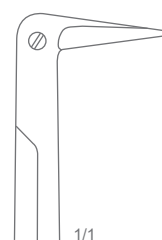

77-285-90
 Angled 90°

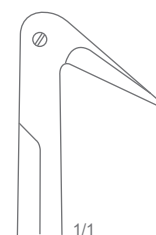

77-287-00
 Angled 125°

Standard Blade

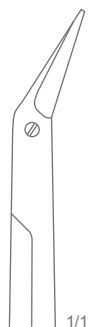

77-289-25
 Angled 25°

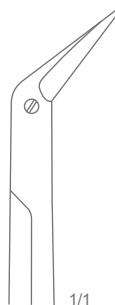

77-289-45
 Angled 45°

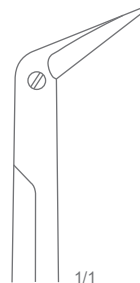

77-289-60
 Angled 60°

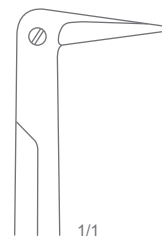

77-289-90
 Angled 90°

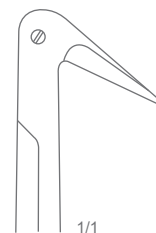

77-291-00
 Angled 125°

Delicate Blade

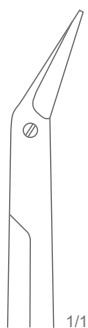

77-293-25
 Angled 25°

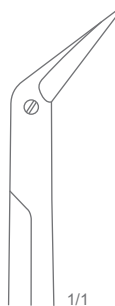

77-293-45
 Angled 45°

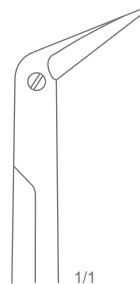

77-293-60
 Angled 60°

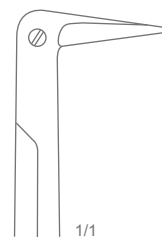

77-293-90
 Angled 90°



77-295-00
 Angled 125°

Ultra Delicate Blade

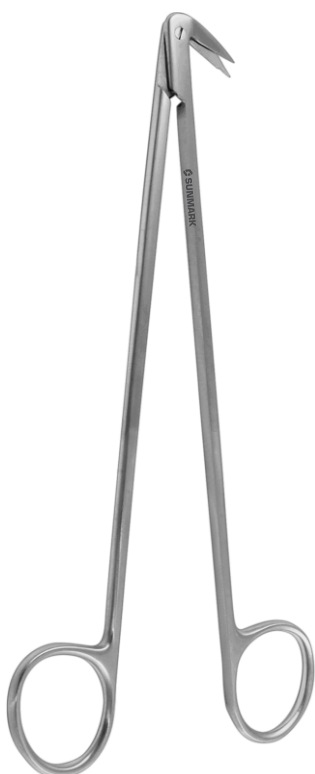

Potts-Smith Vascular Scissor
 Overall Length 18 cm (7")

Vascular Scissors
Gefäßscheren
Tijeras vasculares
Ciseaux vasculaires
Forbici vascolari

77

THORAX, CARDIOVASCULAR SURGERY



77-299-22
Potts-De Martel Cardiovascular Scissor
Angled 60°
Overall Length 22 cm (8 3/4")



77-301-16
DeBakey Offset Scissor
S Shaped
Overall Length 15.5 cm (6")

Vascular Scissors
Gefäßscheren
Tijeras vasculares
Ciseaux vasculaires
Forbici vascolari

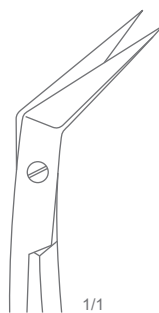

1/1

77-303-15
Favaloro Offset Scissor
Angled
Overall Length 15 cm (6")

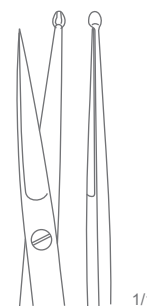

1/1

77-306-12
Vascular Scissor
One Blade Probe
Overall Length 12 cm (4 3/4")

Vascular Scissors
Gefäßscheren
Tijeras vasculares
Ciseaux vasculaires
Forbici vascolari

THORAX, CARDIOVASCULAR SURGERY



77-308-14
Vascular Scissor
One Blade Probe
Overall Length 14.5 cm (5 3/4")



77-311-22
Strully Vascular Scissor
Curved
Overall Length 22 cm (8 3/4")

Vascular Scissors
Gefäßscheren
Tijeras vasculares
Ciseaux vasculaires
Forbici vascolari

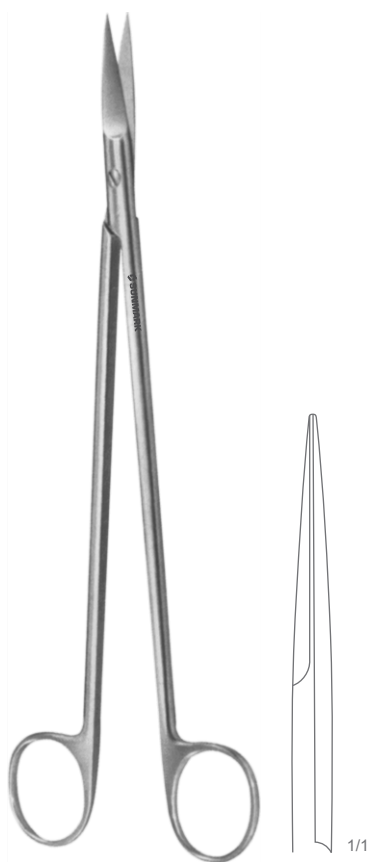
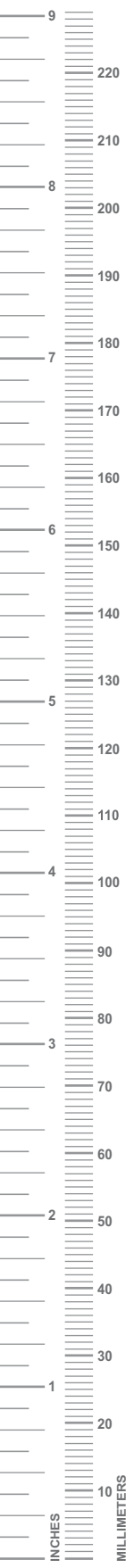

77-312-22
Vascular Scissor
Straight
Overall Length 22.5 cm (8 3/4")



77-314-28
Barre Vascular Scissor
Straight
Overall Length 28 cm (11")

Vascular Scissors
Gefäßscheren
Tijeras vasculares
Ciseaux vasculaires
Forbici vascolari

THORAX, CARDIOVASCULAR SURGERY



77-315-19
Potts-Smith Vascular Scissor
Curved
Overall Length 19 cm (7 ½")

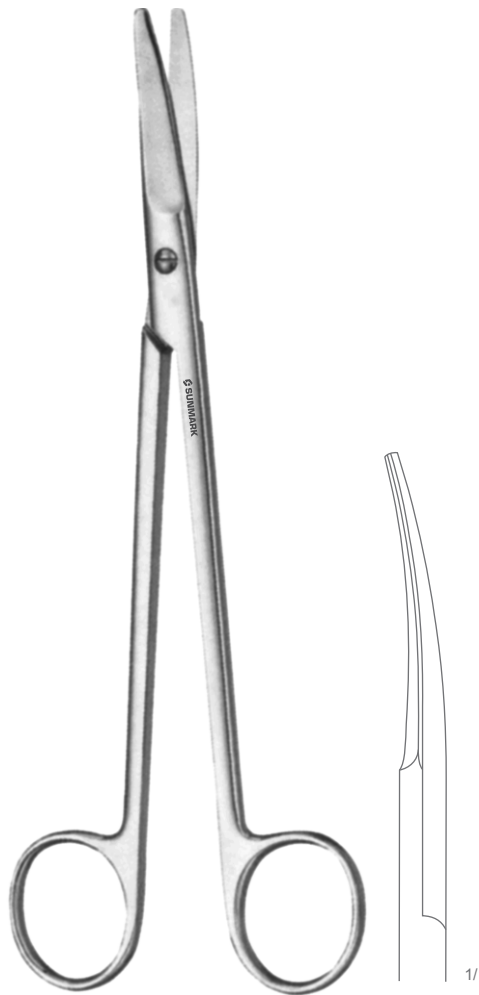

77-317-19
Cooley Vascular Scissor
Curved
Overall Length 19 cm (7 ½")

Vascular Scissors
Gefäßscheren
Tijeras vasculares
Ciseaux vasculaires
Forbici vascolari

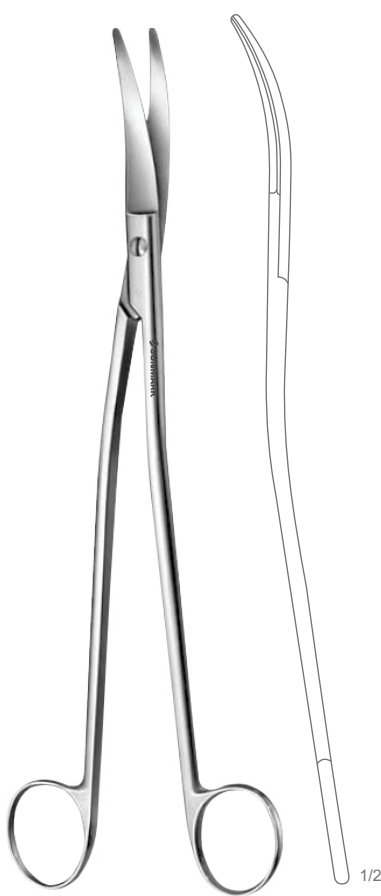

77-319-23
Klinkenberg-Loth Vascular Scissor
S Shaped
Overall Length 23 cm (9")

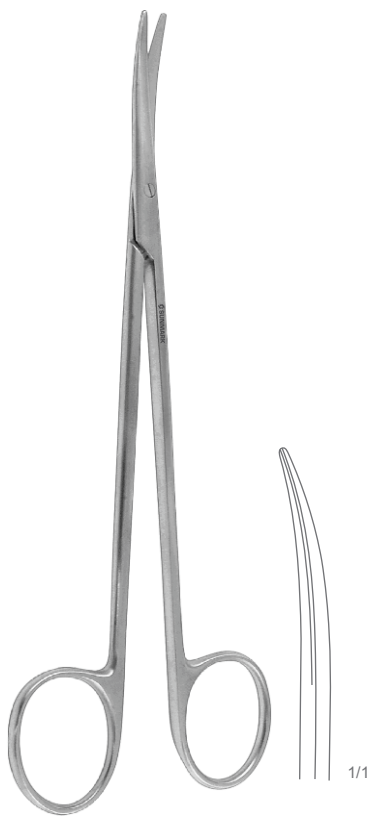

77-329-17
Toennis-Adson Dissecting Scissor
Curved
Overall Length 17.5 cm (7")

Vascular Scissors
Gefäßscheren
Tijeras vasculares
Ciseaux vasculaires
Forbici vascolari

THORAX, CARDIOVASCULAR SURGERY



Toennis Dissecting Scissor
Overall Length 18 cm (7")



77-332-18
Straight
Very Delicate



77-334-18
Straight
Delicate

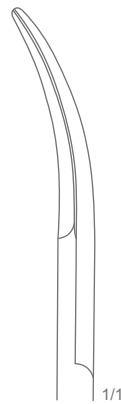

77-335-18
Curved
Delicate

Operating Scissors
Chirurgische Scheren
Tijeras quirúrgicas
Ciseaux chirurgicaux
Forbici per chirurgia

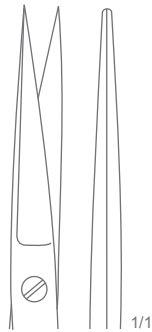

77-402-12
Straight



77-403-12
Curved

Wagner Operating Scissor
Overall Length 12 cm (4 3/4")

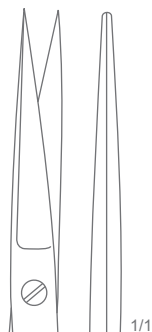

77-402-12 SC
Straight

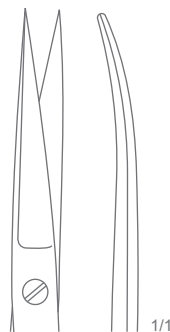

77-403-12 SC
Curved

Wagner Operating Scissor
Overall Length 12 cm (4 3/4")

Iris Scissors
Irisscheren
Tijeras para iridectomia
Ciseaux à iridectomie
Forbici per iridectomia

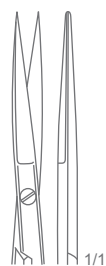

77-430-09
Straight
9 cm (3 1/2")

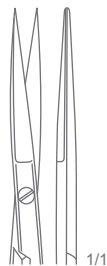

77-430-10
Straight
10 cm (4")



77-431-09
Curved
9 cm (3 1/2")

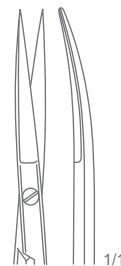

77-431-10
Curved
10 cm (4")

Iris Scissor



77-432-10
Iris Scissor
With Extra Flat Blades
Overall Length 10 cm (4")

Iris Scissors
 Irisscheren
 Tijeras para iridectomía
 Ciseaux à iridectomie
 Forbici per iridectomia

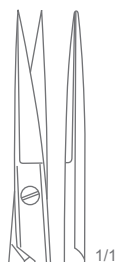

77-440-11
Straight

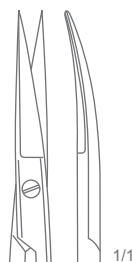

77-441-11
Curved

Iris Scissor
Overall Length 11.5 cm (4 1/2")



SUPEREdge™

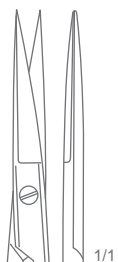

77-440-11
Straight

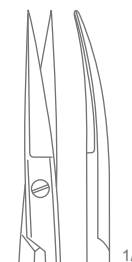

77-441-11
Curved

Iris Scissor
Overall Length 11.5 cm (4 1/2")



Iris Scissors
 Irisscheren
 Tijeras para iridectomia
 Ciseaux à iridectomie
 Forbici per iridectomia



77-443-11
Iris Scissor
 Curved to Side
 Overall Length 11.5 cm (4 1/2")

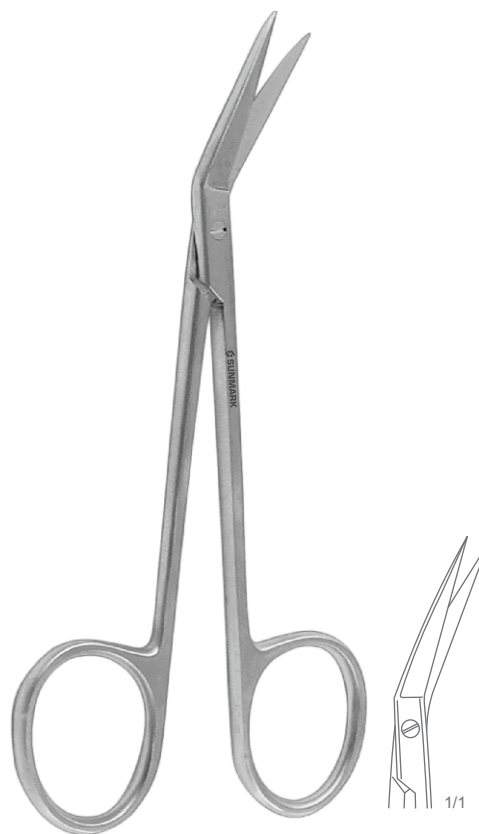

77-445-11
Iris Scissor
 Angled
 Overall Length 11.5 cm (4 1/2")

Iris Scissors
 Irisscheren
 Tijeras para iridectomía
 Ciseaux à iridectomie
 Forbici per iridectomia

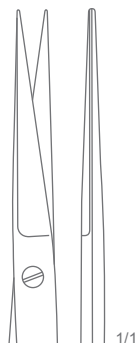

77-446-12
Straight

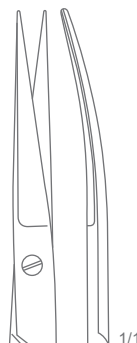

77-447-12
Curved

Iris Scissor
Overall Length 12.5 cm (5")

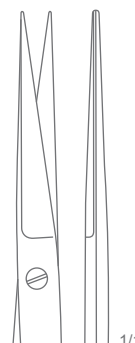

77-446-12 SC
Straight

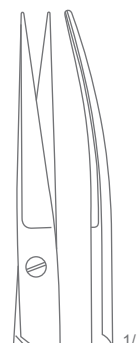

77-447-12 SC
Curved

Iris Scissor
Overall Length 12.5 cm (5")

Stevens Tenotomy Scissor
Rippensperrer
Separadores costales
Ecarteurs des côtes
Divaricatori costali



77-450-10
Straight
10 cm (4")



77-450-11
Straight
11 cm (4 1/2")



77-451-10
Curved
10 cm (4")

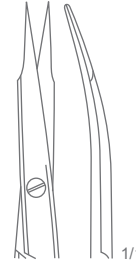

77-451-11
Curved
11 cm (4 1/2")

Stevens Tenotomy Scissor
Sharp/Sharp

THORAX, CARDIOVASCULAR SURGERY

SUPER*Edge*[™]



77-450-10 SC
Straight
10 cm (4")



77-450-11 SC
Straight
11 cm (4 1/2")



77-451-10 SC
Curved
10 cm (4")



77-451-11 SC
Curved
11 cm (4 1/2")

Stevens Tenotomy Scissor
Sharp/Sharp

52 mm

Stevens Tenotomy Scissor
Rippensperrer
Separadores costales
Ecarteurs des côtes
Divaricatori costali



Stevens Tenotomy Scissor
Blunt/Blunt



77-452-10
Straight
10 cm (4")

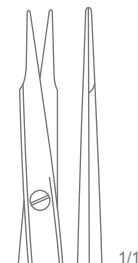

77-452-11
Straight
11 cm (4 1/2")



77-452-12
Straight
12.5 cm (5")



77-453-10
Curved
10 cm (4")



77-453-11
Curved
11 cm (4 1/2")



77-453-12
Curved
12.5 cm (5")

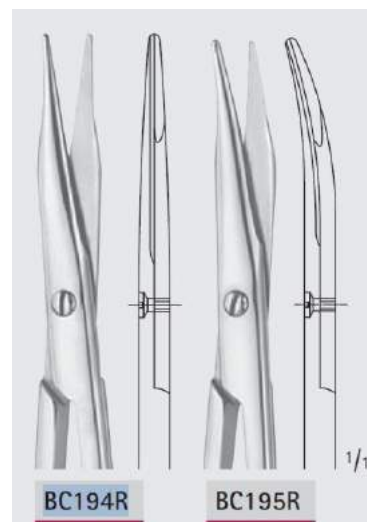

BC194R

BC195R

SUPER*Edge*[™]



77-452-11 SC
Straight



77-453-11
Curved



Stevens Tenotomy Scissor
Blunt/Blunt
Overall Length 11 cm (4 1/2")

Dissecting Scissors
 Präparierscheren
 Tijeras de disección
 Ciseaux à dissection
 Forbici per dissezione

THORAX, CARDIOVASCULAR SURGERY

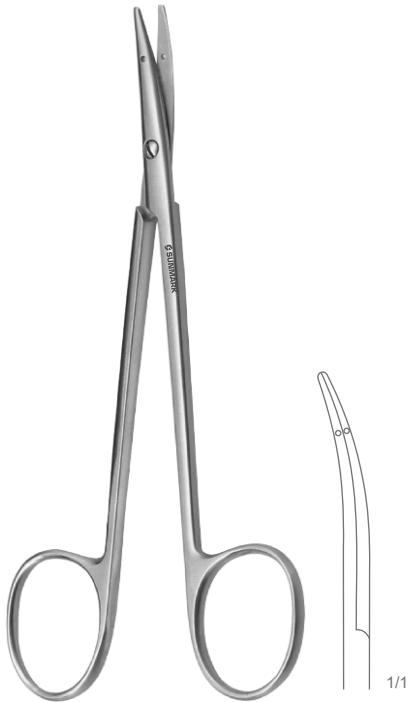

77-461-11
Littler Dissecting Scissor
 Curved, Tip With Eye For Suture
 Overall Length 11.5 cm (4 ½")



77-463-11
Cottle Bulldog Scissor
 Curved
 Overall Length 11.5 cm (4 ½")

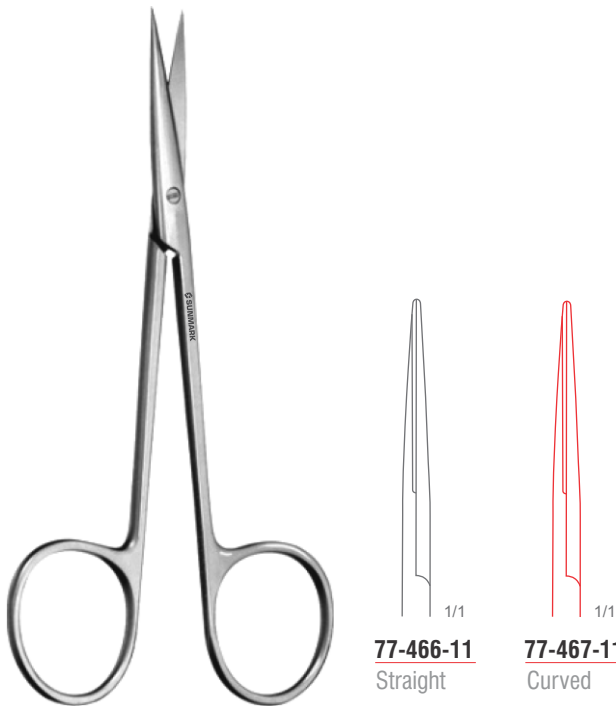

Kilner Delicate Dissecting Scissor
 Overall Length 11.5 cm (4 ½")

77-466-11
 Straight

77-467-11
 Curved

Wire Cutting Scissors
 Drahtscheren
 Tijeras para cortar hilos de acero
 Ciseaux coupe-fil
 Forbici per tagliare fili metallic



77-551-12
Universal Wire Cutting Scissor
 Angled, One Toothed Cutting Edge
 Overall Length 12 cm (4 3/4")

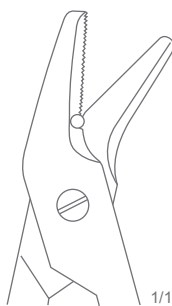

1/1



77-553-12
Heath Suture Scissor
 One Toothed Cutting Edge
 Overall Length 16 cm (6 1/4")

Wire Cutting Scissors
Drahtscheren
Tijeras para cortar hilos de acero
Ciseaux coupe-fil
Forbici per tagliare fili metallic



77-554-12
Harvey Wire Cutting Scissor
Straight, One Toothed Cutting Edge
Overall Length 12.5 cm (5")



77-591-14
14.5 cm (5 ¾")
77-591-18
18.5 cm (7 ¼")
77-591-20
20 cm (8")

Lister Bandage Scissor

Micro Scissors
Mikroscheren
Micro-Tijeras
Micro-Ciseaux
Micro-Forbici



77-620-01

Straight
Blunt/Blunt

77-620-02

Straight
Sharp/Blunt

77-620-03

Straight
Sharp/Sharp

Mueller Type Micro Scissor

Round Handle
Overall Length 12 cm (4 3/4")



77-621-01

Curved
Blunt/Blunt

77-621-02

Curved
Sharp/Blunt

77-621-03

Curved
Sharp/Sharp

Mueller Type Micro Scissor

Round Handle
Overall Length 12 cm (4 3/4")



77-622-01

Straight
Blunt/Blunt

77-622-02

Straight
Sharp/Blunt

77-622-03

Straight
Sharp/Sharp

Mueller Type Micro Scissor

Round Handle
Overall Length 15 cm (6")



77-623-01

Curved
Blunt/Blunt

77-623-02

Curved
Sharp/Blunt

77-623-03

Curved
Sharp/Sharp

Mueller Type Micro Scissor

Round Handle
Overall Length 15 cm (6")



Micro Scissors
 Mikroscheren
 Micro-Tijeras
 Micro-Ciseaux
 Micro-Forbici

THORAX, CARDIOVASCULAR SURGERY



77-636-12
 Straight

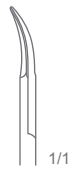

77-637-12
 Curved

Micro Scissor

13 mm Long Blades Max. With 10 mm Cutting Edge
 Overall Length 12 cm (4 3/4")



77-726-12

Vannas Micro Scissor
 Straight, 10 mm Long Blades With
 Max. 4 mm Cutting Edge
 Overall Length 12 cm (4 3/4")



77-727-12

Vannas Micro Scissor
 Curved, 10 mm Long Blades With
 Max. 4 mm Cutting Edge
 Overall Length 12 cm (4 3/4")



77-729-12

Vannas Micro Scissor
 Angled on Flat, 10 mm Long Blades With
 Max. 4 mm Cutting Edge
 Overall Length 12 cm (4 3/4")

Micro Scissors
Mikroscheren
Micro-Tijeras
Micro-Ciseaux
Micro-Forbici

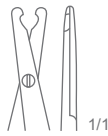

77-730-13
Biemer Vein Scissor
Overall Length 13 cm (5")

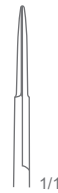
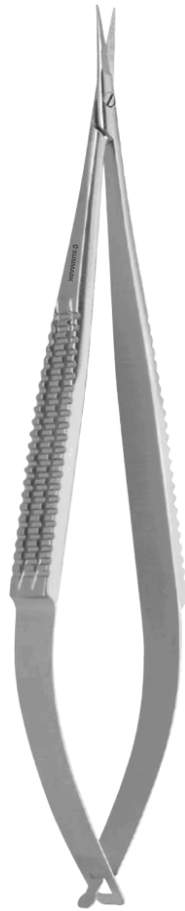

77-732-16
Straight



77-733-16
Curved

Micro Scissor
Overall Length 16 cm (6 1/4")

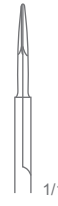
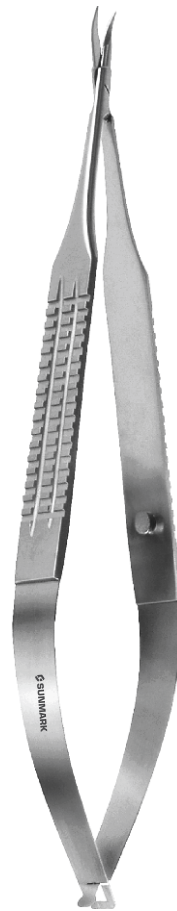

77-734-16
Straight

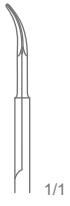

77-735-16
Curved

Vannas Micro Scissor
Overall Length 16 cm (6 1/4")

Micro Scissors
Mikroscheren
Micro-Tijeras
Micro-Ciseaux
Micro-Forbici

THORAX, CARDIOVASCULAR SURGERY

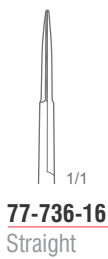

77-736-16
Straight

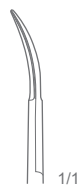

77-737-16
Curved

Millesi Micro Scissor
Serrated
Overall Length 16 cm (6 1/4")



77-738-18
Straight
Yasargil



77-739-18
Curved
Jacobson

Yasargil Micro Scissor
Overall Length 18.5 cm (7 1/4")

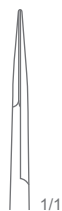

77-740-14
Straight
Sharp/Sharp

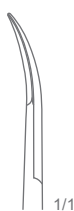

77-741-14
Curved
Sharp/Sharp

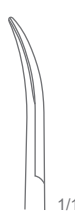

77-743-14
Curved
Blunt/Blunt

Adventitia Micro Scissor
Overall Length 14.5 cm (5 3/4")

Micro Scissors
Mikroscheren
Micro-Tijeras
Micro-Ciseaux
Micro-Forbici



Micro Scissor
Overall Length 16.5 cm (6 1/2")



77-744-16
Straight
Delicate Blades



77-745-16
Curved
Delicate Blades

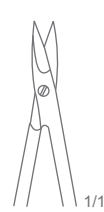

77-746-16
Straight
Extra Delicate Blades

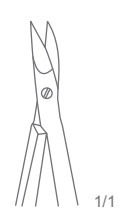

77-747-16
Curved
Extra Delicate Blades

Micro Scissors
Mikroscheren
Micro-Tijeras
Micro-Ciseaux
Micro-Forbici

THORAX, CARDIOVASCULAR SURGERY

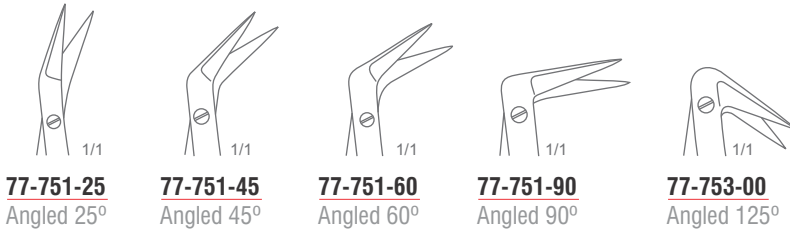

77-751-25
Angled 25°

77-751-45
Angled 45°

77-751-60
Angled 60°

77-751-90
Angled 90°

77-753-00
Angled 125°

Micro Coronary Scissor
Overall Length 18 cm (7")

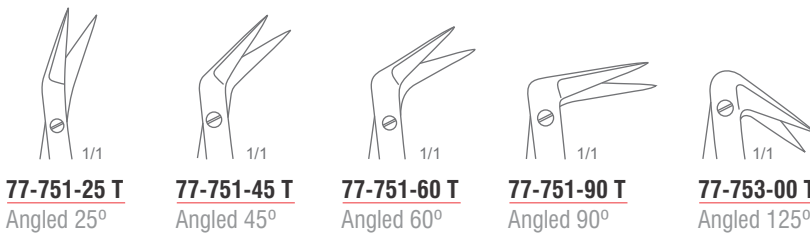
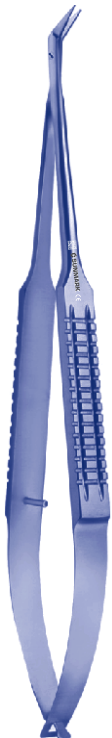

77-751-25 T
Angled 25°

77-751-45 T
Angled 45°

77-751-60 T
Angled 60°

77-751-90 T
Angled 90°

77-753-00 T
Angled 125°



Micro Coronary Scissor
Overall Length 18 cm (7")

Micro Scissors
 Mikroscheren
 Micro-Tijeras
 Micro-Ciseaux
 Micro-Forbici



Micro Coronary Scissor
 Overall Length 16.5 cm (6 1/2")



77-755-25
 Fine Blades
 Angled 45°

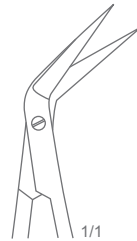

77-755-45
 Fine Blades
 Angled 45°

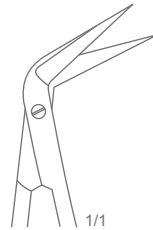

77-755-60
 Fine Blades
 Angled 60°

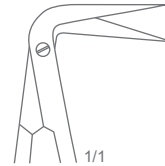

77-755-90
 Fine Blades
 Angled 90°



77-757-00
 Fine Blades
 Angled 125°



77-759-25
 Fine Blades
 One Blade
 Probe Tip
 Angled 25°

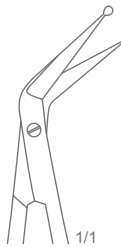

77-759-45
 Fine Blades
 One Blade
 Probe Tip
 Angled 45°

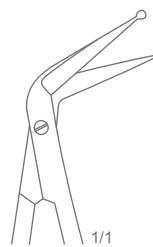

77-759-60
 Fine Blades
 One Blade
 Probe Tip
 Angled 60°

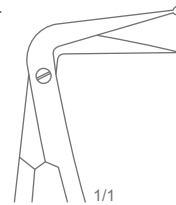

77-759-90
 Fine Blades
 One Blade
 Probe Tip
 Angled 90°

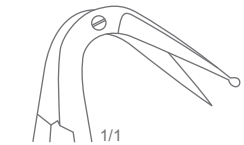

77-761-00
 Fine Blades
 One Blade
 Probe Tip
 Angled 125°



77-763-25
 Delicate
 Blades
 Angled 25°



77-763-45
 Delicate
 Blades
 Angled 45°



77-763-60
 Delicate
 Blades
 Angled 60°

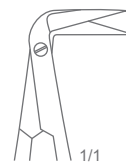

77-763-90
 Delicate
 Blades
 Angled 90°



77-765-00
 Delicate
 Blades
 Angled 125°



77-767-25
 Extra Delicate
 Blades
 Angled 25°



77-767-45
 Extra Delicate
 Blades
 Angled 45°

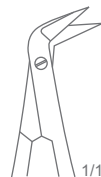

77-767-60
 Extra Delicate
 Blades
 Angled 60°

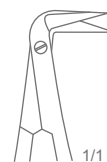

77-767-90
 Extra Delicate
 Blades
 Angled 90°



77-769-00
 Extra Delicate
 Blades
 Angled 125°

Micro Scissors
 Mikroscheren
 Micro-Tijeras
 Micro-Ciseaux
 Micro-Forbici



77-775-25
 Fine Blades
 Angled 25°
 23 cm (9")

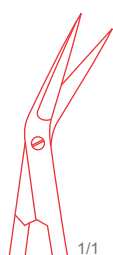

77-775-25 L
 Fine Blades
 Angled 25°
 23 cm (9")

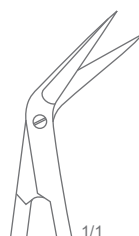

77-775-45
 Fine Blades
 Angled 45°
 23 cm (9")

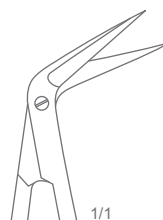

77-775-60
 Fine Blades
 Angled 60°
 23 cm (9")

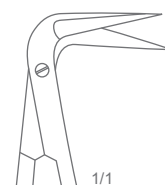

77-775-90
 Fine Blades
 Angled 90°
 23 cm (9")

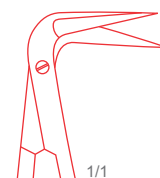

77-775-90 L
 Fine Blades
 Angled 90°
 23 cm (9")

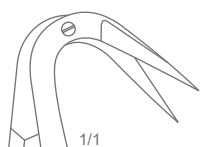

77-777-00
 Fine Blades
 Angled 125°
 23 cm (9")



77-779-25
 Fine Blades
 One Blade
 Probe Tip
 Angled 25°



77-779-45
 Fine Blades
 One Blade
 Probe Tip
 Angled 45°



77-779-60
 Fine Blades
 One Blade
 Probe Tip
 Angled 60°

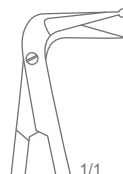

77-779-90
 Fine Blades
 One Blade
 Probe Tip
 Angled 90°



77-781-00
 Fine Blades
 One Blade
 Probe Tip
 Angled 125°

Micro Coronary Scissor

Round Handle
 Overall Length 16.5 cm (6 1/2")

Micro Scissors
 Mikroscheren
 Micro-Tijeras
 Micro-Ciseaux
 Micro-Forbici



Micro Coronary Scissor

Round Handle
 Overall Length 16.5 cm (6 1/2")



77-783-25
 Delicate
 Blades
 Angled 25°



77-783-25 XL
 Delicate
 Blades
 Angled 25°
 23 cm (9")

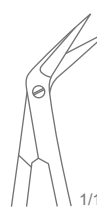

77-783-45
 Delicate
 Blades
 Angled 45°

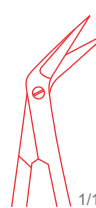

77-783-45 L
 Delicate
 Blades
 Angled 45°
 20 cm (8")



77-783-60
 Delicate
 Blades
 Angled 60°



77-783-60 L
 Delicate
 Blades
 Angled 60°
 20 cm (8")

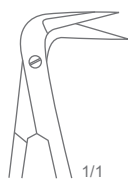

77-783-90
 Delicate
 Blades
 Angled 90°

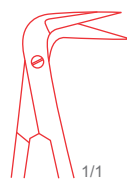

77-783-90 L
 Delicate
 Blades
 Angled 90°
 20 cm (8")

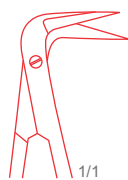

77-783-90 XL
 Delicate
 Blades
 Angled 90°
 23 cm (9")



77-785-00
 Delicate
 Blades
 Angled 125°



77-785-00 L
 Delicate
 Blades
 Angled 125°
 23 cm (9")



77-787-25
 Extra Delicate
 Blades
 Angled 25°



77-787-45
 Extra Delicate
 Blades
 Angled 45°



77-787-60
 Extra Delicate
 Blades
 Angled 60°



77-787-90
 Extra Delicate
 Blades
 Angled 90°



77-789-00
 Extra Delicate
 Blades
 Angled 125°

Micro Scissors
Mikroscheren
Micro-Tijeras
Micro-Ciseaux
Micro-Forbici

THORAX, CARDIOVASCULAR SURGERY

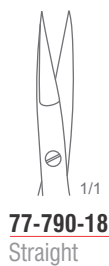
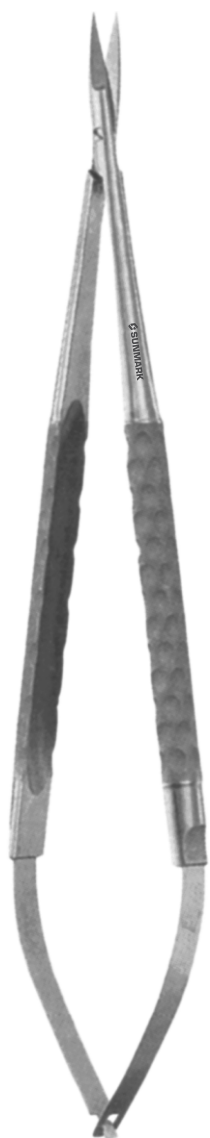

Micro Scissor
Round Handle
Overall Length 18 cm (7")



Micro Scissors
 Mikroscheren
 Micro-Tijeras
 Micro-Ciseaux
 Micro-Forbici



Micro Scissor
 Round Handle



77-800-15
 Straight
 15 cm (6")

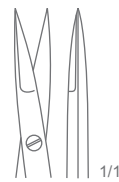

77-800-18
 Straight
 18 cm (7")



77-800-21
 Straight
 21 cm (8 1/4")

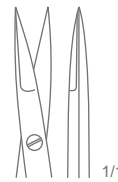

77-800-23
 Straight
 23 cm (9")



Micro Scissor
 Round Handle



77-800-15 T
 Straight
 15 cm (6")

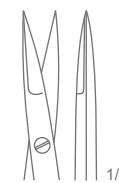

77-800-18 T
 Straight
 18 cm (7")



77-800-21 T
 Straight
 21 cm (8 1/4")



Operating Scissors
 Chirurgische Scheren
 Tijeras quirúrgicas
 Ciseaux chirurgicaux
 Forbici per chirurgia



77-801-15
 Straight
 15 cm (6")

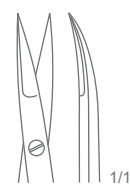

77-801-18
 Straight
 18 cm (7")



77-801-21
 Straight
 21 cm (8 1/4")

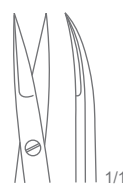

77-801-23
 Straight
 23 cm (9")

Micro Scissor
 Round Handle

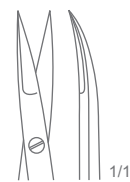

77-801-15 T
 Straight
 15 cm (6")

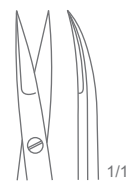

77-801-18 T
 Straight
 18 cm (7")

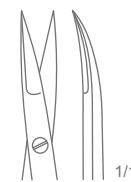

77-801-21 T
 Straight
 21 cm (8 1/4")



Micro Scissor
 Round Handle



Micro Scissors
 Mikroscheren
 Micro-Tijeras
 Micro-Ciseaux
 Micro-Forbici

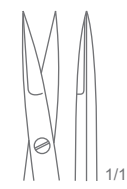

77-804-15
 Straight
 15 cm (6")

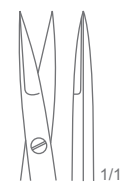

77-804-18
 Straight
 18 cm (7")

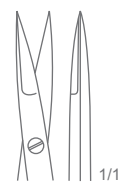

77-804-21
 Straight
 21 cm (8 1/4")

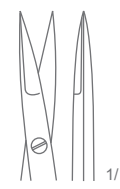

77-804-23
 Straight
 23 cm (9")

Micro Scissor
 Blade Length 10 mm, Flat Handle

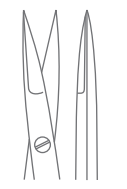

77-804-15 T
 Straight
 15 cm (6")

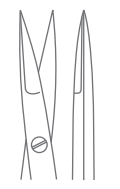

77-804-18 T
 Straight
 18 cm (7")

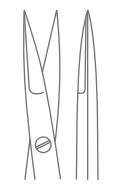

77-804-21 T
 Straight
 21 cm (8 1/4")



Micro Scissor
 Blade Length 10 mm, Flat Handle

Operating Scissors
 Chirurgische Scheren
 Tijeras quirúrgicas
 Ciseaux chirurgicaux
 Forbici per chirurgia



77-805-15
 Straight
 15 cm (6")

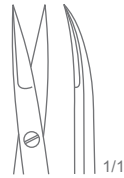

77-805-18
 Straight
 18 cm (7")

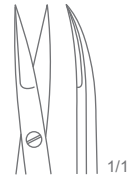

77-805-21
 Straight
 21 cm (8 ¼")

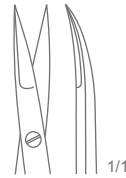

77-805-23
 Straight
 23 cm (9")

Micro Scissor

Blade Length 10 mm, Flat Handle

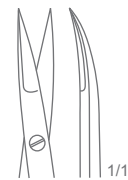

77-805-15 T
 Straight
 15 cm (6")

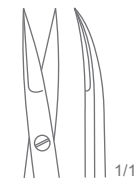

77-805-18 T
 Straight
 18 cm (7")

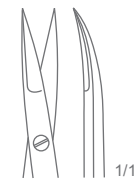

77-805-21 L
 Straight
 21 cm (8 ¼")



Micro Scissor

Blade Length 10 mm, Flat Handle

Operating Scissors
Chirurgische Scheren
Tijeras quirúrgicas
Ciseaux chirurgicaux
Forbici per chirurgia

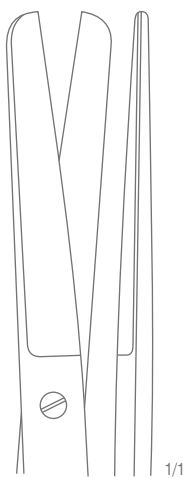

77-850-14
Straight

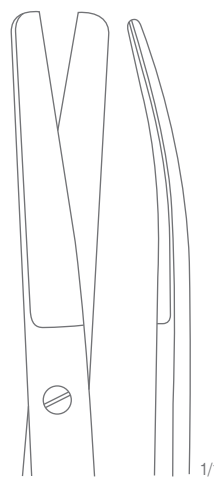

77-851-14
Curved

UltraCut™ TC Operating Scissor
Blunt/Blunt
Overall Length 14.5 cm (5 ¾")

ULTRA *Cut*™

Operating Scissors
Chirurgische Scheren
Tijeras quirúrgicas
Ciseaux chirurgicaux
Forbici per chirurgia

THORAX, CARDIOVASCULAR SURGERY

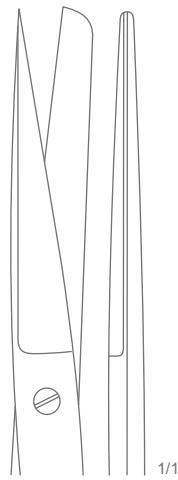

77-852-14
Straight

UltraCut™ TC Operating Scissor
Sharp/Blunt
Overall Length 14.5 cm (5 ¾")

ULTRA *Cut*™

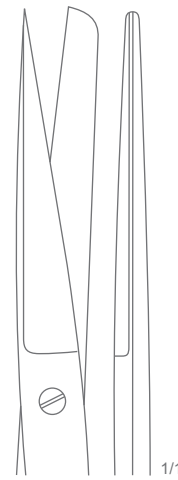

77-852-14 SC
Straight

XTSCut™ TC Operating Scissor
Sharp/Blunt
Overall Length 14.5 cm (5 ¾")

XTS *cut*™

Operating Scissors
Chirurgische Scheren
Tijeras quirúrgicas
Ciseaux chirurgicaux
Forbici per chirurgia

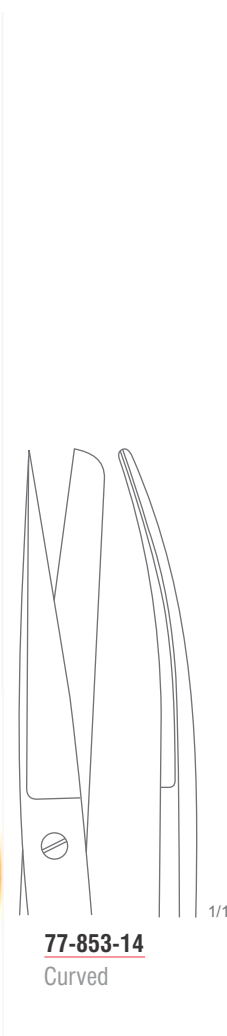

UltraCut™ TC Operating Scissor
Sharp/Blunt
14.5 cm (5 3/4")

ULTRACut™



XTSCut™ TC Operating Scissor
Sharp/Blunt
14.5 cm (5 3/4")

XTSCut™

Operating Scissors
Chirurgische Scheren
Tijeras quirúrgicas
Ciseaux chirurgicaux
Forbici per chirurgia

THORAX, CARDIOVASCULAR SURGERY

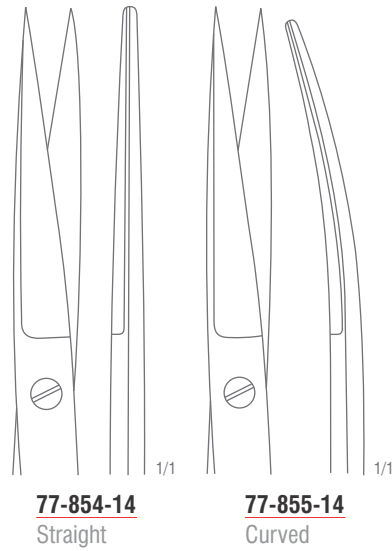

UltraCut™ TC Operating Scissor
Sharp/Sharp
Overall Length 14.5 cm (5 3/4")

ULTRA *Cut*™

Dissecting Scissors
Präparierscheren
Tijeras de disección
Ciseaux à dissection
Forbici per dissezione

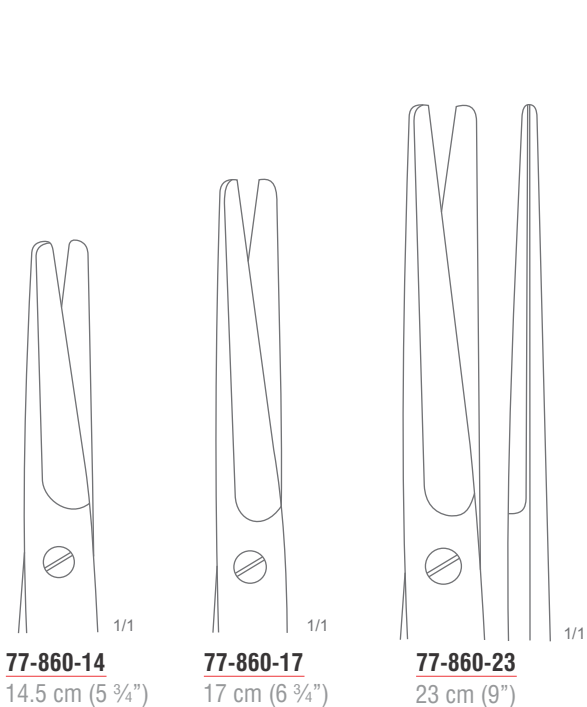

77-860-14
14.5 cm (5 3/4")

77-860-17
17 cm (6 3/4")

77-860-23
23 cm (9")

ULTRA Cut™

UltraCut™ TC Mayo Dissecting Scissor
Straight

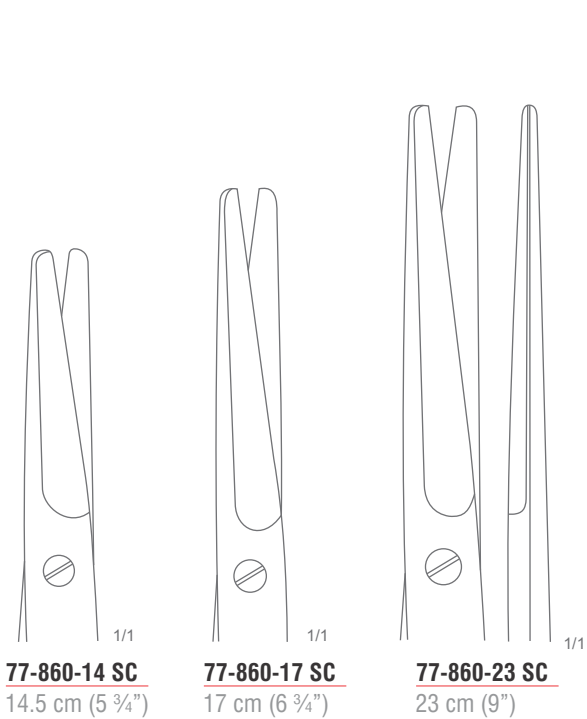

77-860-14 SC
14.5 cm (5 3/4")

77-860-17 SC
17 cm (6 3/4")

77-860-23 SC
23 cm (9")

XTS Cut™

XTSCut™ TC Mayo Dissecting Scissor
Straight

Dissecting Scissors
Präparierscheren
Tijeras de disección
Ciseaux à dissection
Forbici per dissezione



77-861-14
14.5 cm (5 3/4")



77-861-17
17 cm (6 3/4")



77-861-23
23 cm (9")

ULTRA Cut™

UltraCut™ TC Mayo Dissecting Scissor
Curved

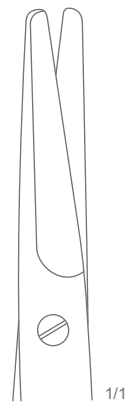

77-861-14 SC
14.5 cm (5 3/4")



77-861-17 SC
17 cm (6 3/4")



77-861-23 SC
23 cm (9")

XTS Cut™

XTSCut™ TC Mayo Dissecting Scissor
Curved

THORAX, CARDIOVASCULAR SURGERY

Dissecting Scissors
Präparierscheren
Tijeras de disección
Ciseaux à dissection
Forbici per dissezione

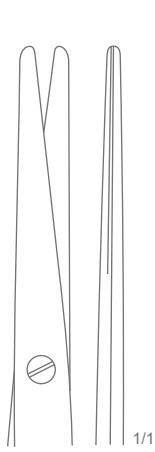

77-890-15
15 cm (6")

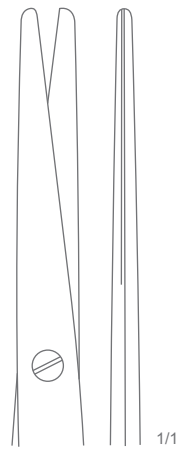

77-890-17
17 cm (6 3/4")

ULTRA *Cut*™

UltraCut™ TC Mayo-Style Dissecting Scissor
Straight

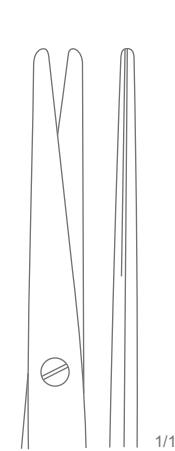

77-890-15 SC
15 cm (6")

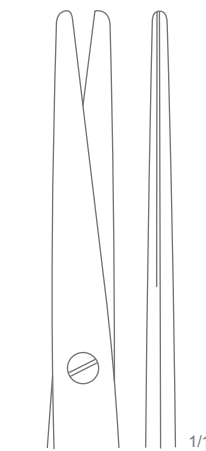

77-890-17 SC
17 cm (6 3/4")

XTS *cut*™

XTSCut™ TC Mayo-Style Dissecting Scissor
Straight

Dissecting Scissors
Präparierscheren
Tijeras de disección
Ciseaux à dissection
Forbici per dissezione

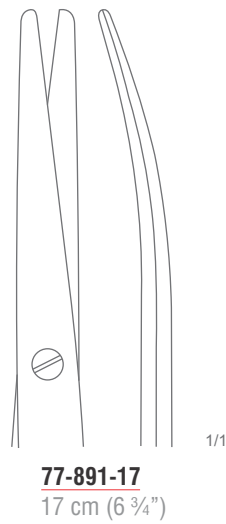

ULTRA Cut™

UltraCut™ TC Mayo-Stille Dissecting Scissor
Curved

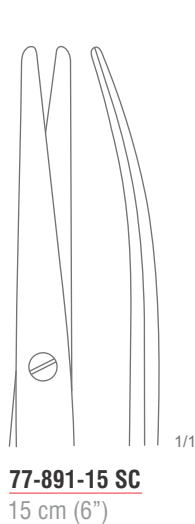

XTS Cut™

XTSCut™ TC Mayo-Stille Dissecting Scissor
Curved

THORAX, CARDIOVASCULAR SURGERY

Dissecting Scissors
Präparierscheren
Tijeras de disección
Ciseaux à dissection
Forbici per dissezione

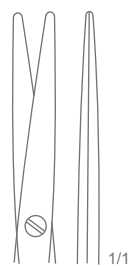

77-900-11
Straight

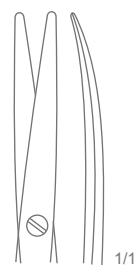

77-901-11
Curved

ULTRA.Cut™

UltraCut™ TC Metzenbaum Dissecting Scissor
Overall Length 11.5 cm (4 1/2")

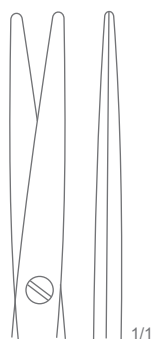

77-902-14
Straight

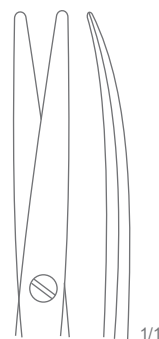

77-903-14
Curved

ULTRA.Cut™

UltraCut™ TC Metzenbaum Dissecting Scissor
Overall Length 14.5 cm (5 3/4")

Dissecting Scissors
 Präparierscheren
 Tijeras de disección
 Ciseaux à dissection
 Forbici per dissezione



XTS·cut™

XTSCut™TC Metzenbaum Dissecting Scissor
 Overall Length 14.5 cm (5 ¾")

Dissecting Scissors
 Präparierscheren
 Tijeras de disección
 Ciseaux à dissection
 Forbici per dissezione

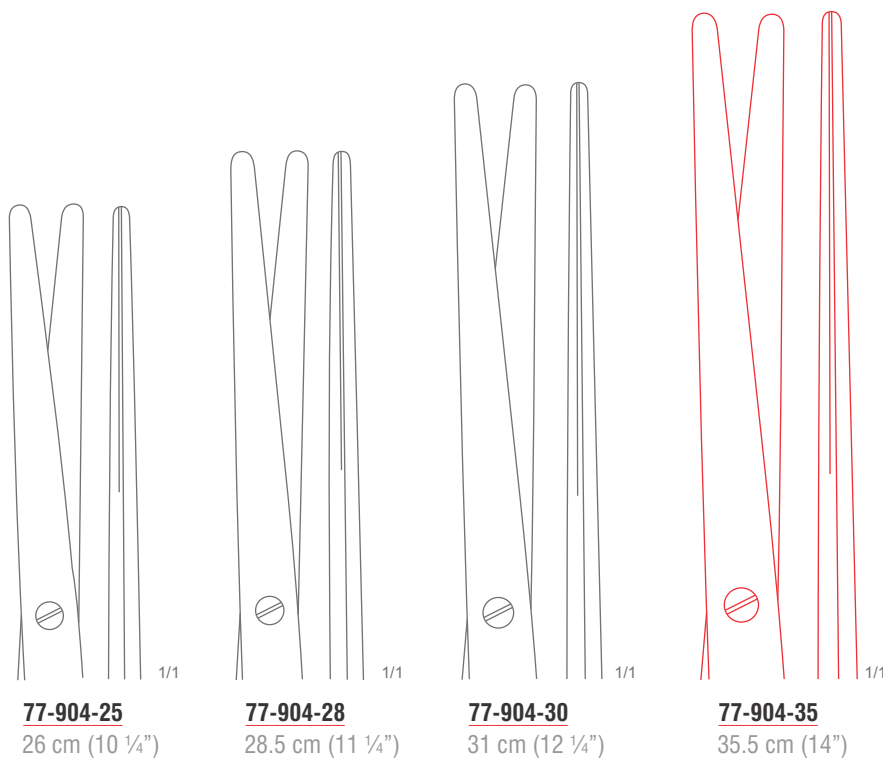

UltraCut™ Metzenbaum-Nelson Dissecting Scissor *ULTRA.Cut™*
 Straight, Blunt/Blunt

Dissecting Scissors
 Präparierscheren
 Tijeras de disección
 Ciseaux à dissection
 Forbici per dissezione

THORAX, CARDIOVASCULAR SURGERY

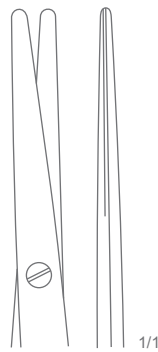

77-904-18 SC
18 cm (7")

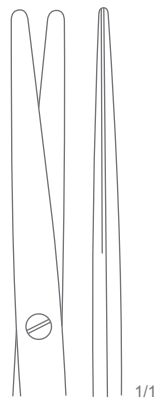

77-904-20 SC
20.5 cm (8")

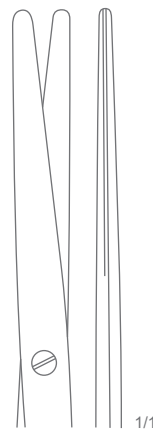

77-904-23 SC
23 cm (9")

XTS-out™

XTSCut™ Metzenbaum-Nelson Dissecting Scissor
 Straight, Blunt/Blunt

Dissecting Scissors
Präparierscheren
Tijeras de disección
Ciseaux à dissection
Forbici per dissezione

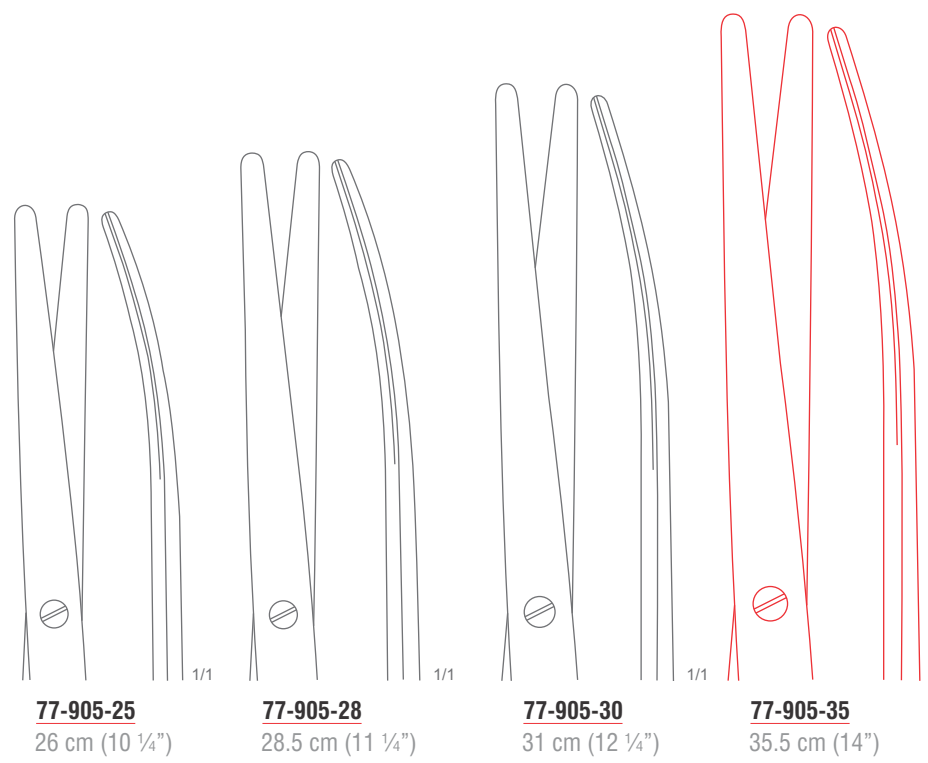

UltraCut™ Metzenbaum-Nelson Dissecting Scissor **ULTRA.Cut™**
Curved, Blunt/Blunt

Dissecting Scissors
Präparierscheren
Tijeras de disección
Ciseaux à dissection
Forbici per dissezione

77

THORAX, CARDIOVASCULAR SURGERY

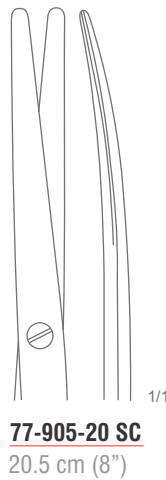
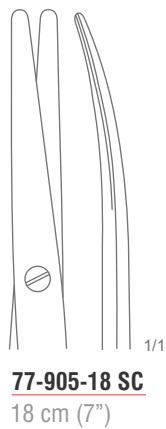

XTSCut™ Metzenbaum-Nelson Dissecting Scissor
Curved, Blunt/Blunt



Dissecting Scissors
 Präparierscheren
 Tijeras de disección
 Ciseaux à dissection
 Forbici per dissezione

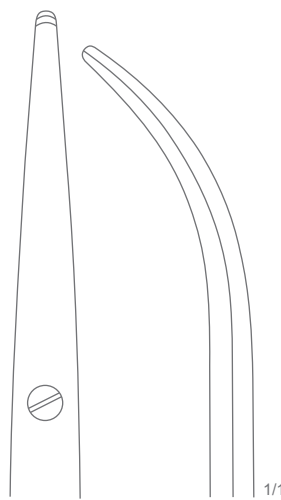

77-907-20
20 cm (8")

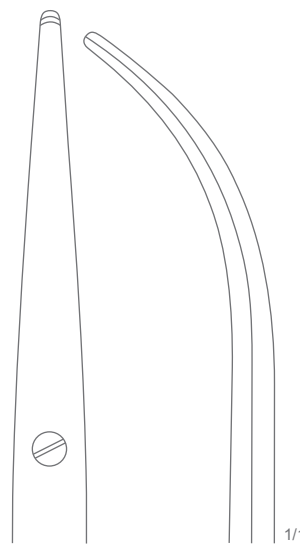

77-907-23
23 cm (9")

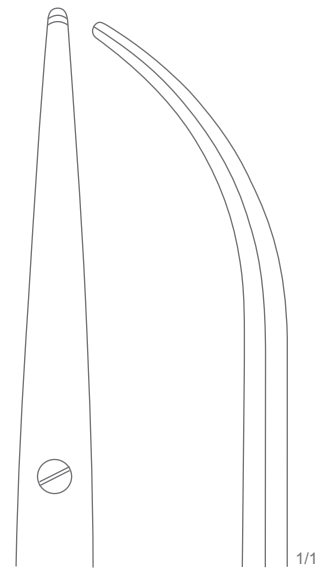

77-907-28
28 cm (11")

UltraCut™ TC Metzenbaum -Thorek Dissecting Scissor
Curved

ULTRA *Cut*™

Dissecting Scissors
 Präparierscheren
 Tijeras de disección
 Ciseaux à dissection
 Forbici per dissezione

THORAX, CARDIOVASCULAR SURGERY

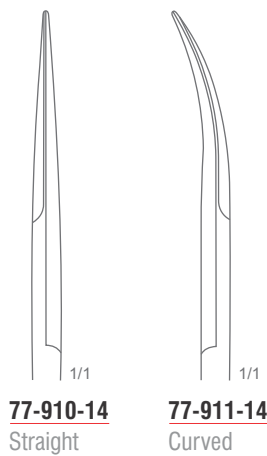

UltraCut™ TC Joseph Dissecting Scissor
 Overall Length 14.5 cm (5 ¾")

ULTRA *Cut*™



Dissecting Scissors
Präparierscheren
Tijeras de disección
Ciseaux à dissection
Forbici per dissezione



UltraCut™ TC Lexer Dissecting Scissor

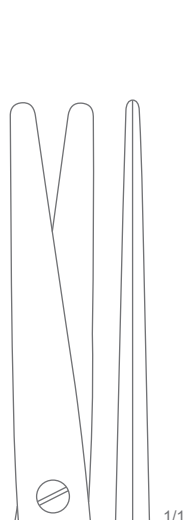

77-914-16
Straight
16 cm (6 1/4")



77-914-21
Straight
21 cm (8 1/4")

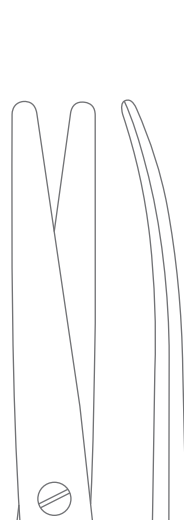

77-915-16
Curved
16 cm (6 1/4")



77-915-21
Curved
21 cm (8 1/4")

ULTRACut™



XTSCut™ TC Lexer Dissecting Scissor

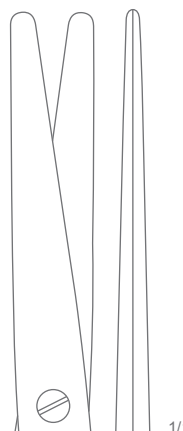

77-914-16 SC
Straight
16 cm (6 1/4")



77-915-16 SC
Curved
16 cm (6 1/4")

XTSCut™

Dissecting Scissors
Präparierscheren
Tijeras de disección
Ciseaux à dissection
Forbici per dissezione



77-917-16

UltraCut™ TC Mayo-Lexer Dissecting Scissor

Curved

Overall Length 16 cm (6 1/4")

ULTRA.Cut™

THORAX, CARDIOVASCULAR SURGERY

Dissecting Scissors
Präparierscheren
Tijeras de disección
Ciseaux à dissection
Forbici per dissezione

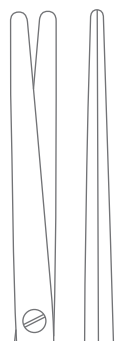

77-920-14
Straight

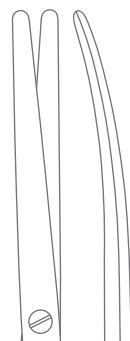

77-921-14
Curved

UltraCut™ TC Metzenbaum-Fine Delicate Dissecting Scissor
Slender Pattern
Overall Length 14.5 cm (5 3/4")

ULTRA Cut™

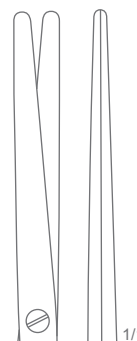

77-920-14 SC
Straight

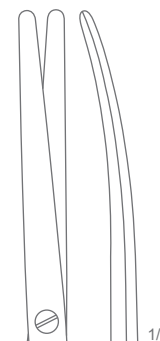

77-921-14 SC
Curved

XTSCut™ TC Metzenbaum-Fine Delicate Dissecting Scissor
Slender Pattern
Overall Length 14.5 cm (5 3/4")

XTS Cut™

Dissecting Scissors
 Präparierscheren
 Tijeras de disección
 Ciseaux à dissection
 Forbici per dissezione

77

THORAX, CARDIOVASCULAR SURGERY

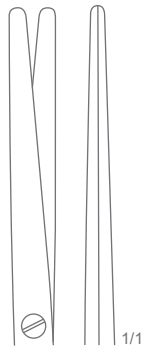

77-922-18
 Straight
 18 cm (7")

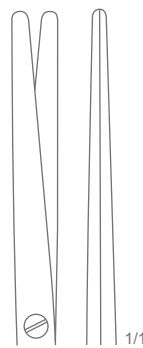

77-922-20
 Straight
 20.5 cm (8")

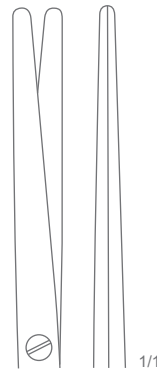

77-922-23
 Straight
 23 cm (9")

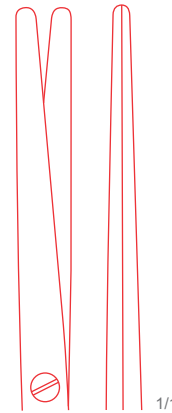

77-922-25
 Straight
 25 cm (9 3/4")

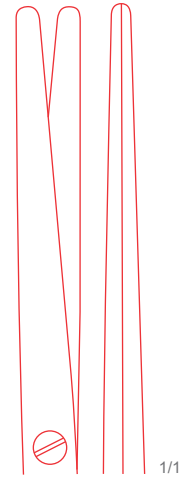

77-922-28
 Straight
 28 cm (11")



77-923-18
 Curved
 18 cm (7")

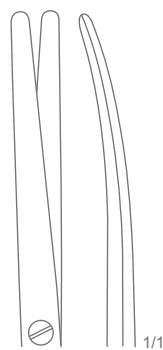

77-923-20
 Curved
 20.5 cm (8")

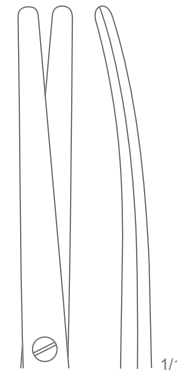

77-923-23
 Curved
 23 cm (9")

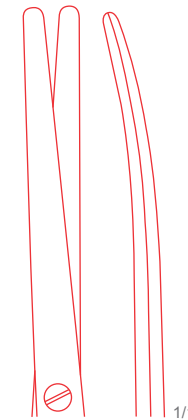

77-923-25
 Curved
 25 cm (9 3/4")

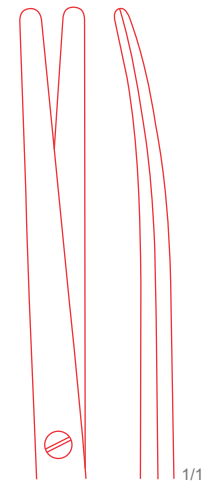

77-923-28
 Curved
 28.5 cm (11 1/4")

UltraCut™ TC Metzenbaum-Fine Delicate Dissecting Scissor
 Slender Pattern

ULTRA *Cut*™

Dissecting Scissors
Präparierscheren
Tijeras de disección
Ciseaux à dissection
Forbici per dissezione

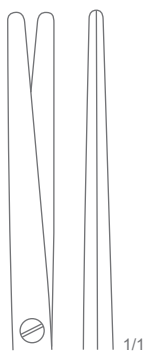

77-922-18 SC
Straight
18 cm (7")

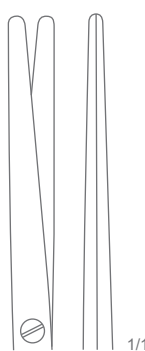

77-922-20 SC
Straight
20.5 cm (8")

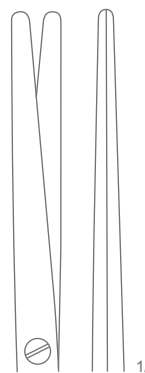

77-922-23 SC
Straight
23 cm (9")



77-923-18 SC
Curved
18 cm (7")

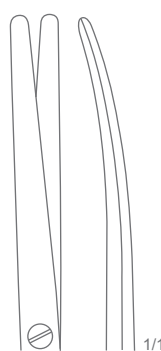

77-923-20 SC
Curved
20.5 cm (8")

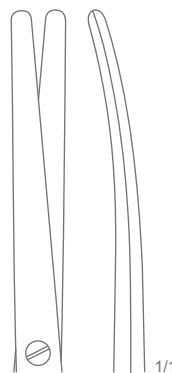

77-923-23 SC
Curved
23 cm (9")

XTSCut™ TC Metzenbaum-Fine Delicate Dissecting Scissor
Slender Pattern



Dissecting Scissors
Präparierscheren
Tijeras de disección
Ciseaux à dissection
Forbici per dissezione

THORAX, CARDIOVASCULAR SURGERY

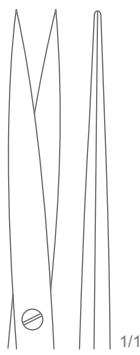

77-926-14
Straight



77-927-14
Curved

UltraCut™ TC Metzenbaum-Fine Delicate Dissecting Scissor
Overall Length 14.5 cm (5 3/4")

ULTRA *Cut*™

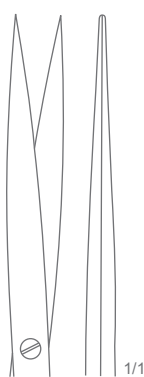

77-928-18
Straight

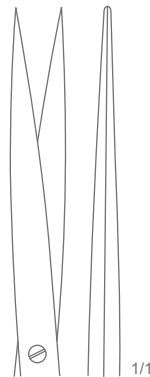

77-928-20
Straight

UltraCut™ TC Metzenbaum-Fine Delicate Dissecting Scissor
Straight

ULTRA *Cut*™

Dissecting Scissors
 Präparierscheren
 Tijeras de disección
 Ciseaux à dissection
 Forbici per dissezione



77-931-14

UltraCut™ TC Metzenbaum-Lahey Dissecting Scissor

Overall Length 14.5 cm (5 3/4")

ULTRA *Cut*™

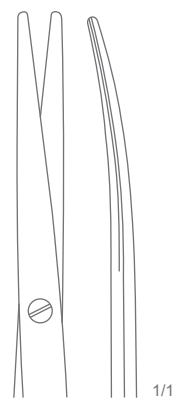

77-933-17

UltraCut™ TC Toennis-Adson Dissecting Scissor

Curved, Slender Pattern
 Overall Length 17.5 cm (7")

ULTRA *Cut*™

Dissecting Scissors
Präparierscheren
Tijeras de disección
Ciseaux à dissection
Forbici per dissezione



UltraCut™ TC Metzenbaum-Lahey Dissecting Scissor
Slender Pattern

ULTRA *Cut*™

Dissecting Scissors
 Präparierscheren
 Tijeras de disección
 Ciseaux à dissection
 Forbici per dissezione

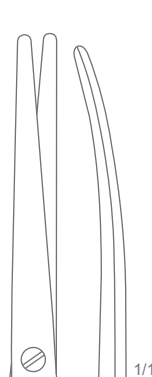
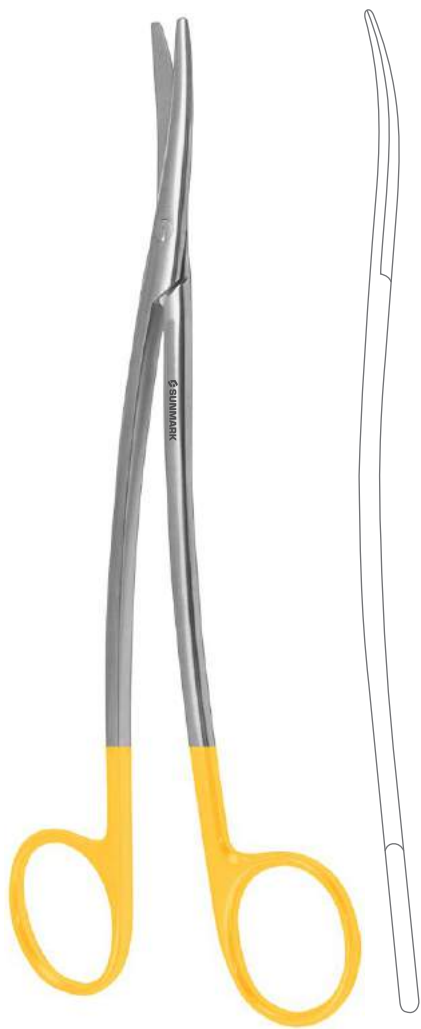

77-937-18
18 cm (7")



77-937-20
20.5 cm (8")

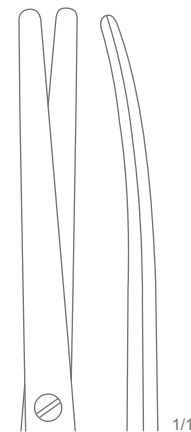

77-937-23
23 cm (9")

UltraCut™ TC Metzenbaum-Fine Dissecting Scissor
 Curved, S Shaped, Slender Pattern

Operating Scissors
 Chirurgische Scheren
 Tijeras quirúrgicas
 Ciseaux chirurgicaux
 Forbici per chirurgia



UltraCut™ TC Stevens Tenotomy Scissor



77-972-10
 Straight
 Blunt/Blunt
 10.5 cm (4 1/4")



77-972-11
 Straight
 Blunt/Blunt
 11.5 cm (4 1/2")



77-973-10
 Curved
 Blunt/Blunt
 10.5 cm (4 1/4")



77-973-11
 Curved
 Blunt/Blunt
 11.5 cm (4 1/2")



77-974-10
 Straight
 Sharp/Sharp
 10.5 cm (4 1/4")



77-974-11
 Straight
 Sharp/Sharp
 11.5 cm (4 1/2")

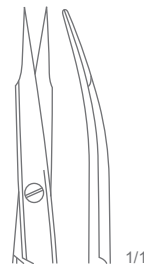

77-975-10
 Curved
 Sharp/Sharp
 10.5 cm (4 1/4")

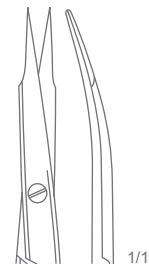

77-975-11
 Curved
 Sharp/Sharp
 11.5 cm (4 1/2")

ULTRACut™

Operating Scissors
Chirurgische Scheren
Tijeras quirúrgicas
Ciseaux chirurgicaux
Forbici per chirurgia



UltraCut™ TC Iris Scissor
Overall Length 11.5 cm (4 1/2")

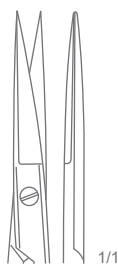

77-978-11
Straight

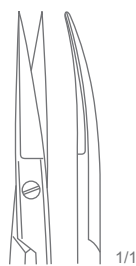

77-979-11
Curved



UltraCut™ TC Iris Scissor
Overall Length 11.5 cm (4 1/2")

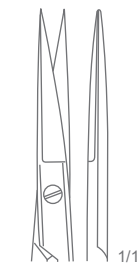

77-978-11 SC
Straight

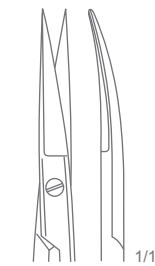

77-979-11 SC
Curved

Operating Scissors
Chirurgische Scheren
Tijeras quirúrgicas
Ciseaux chirurgicaux
Forbici per chirurgia

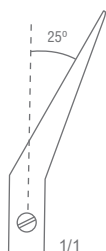

77-981-25
Angled 25°
19 cm (7 1/2")

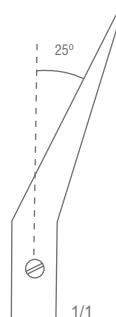

77-983-25
Angled 25°
23 cm (9")

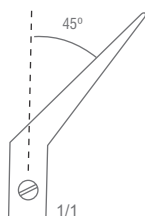

77-981-45
Angled 45°
18.5 cm (7 1/4")

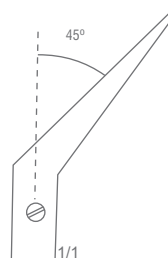

77-983-45
Angled 45°
23 cm (9")

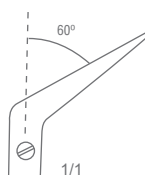

77-981-60
Angled 60°
18 cm (7")

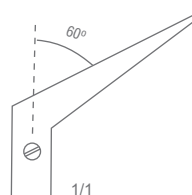

77-983-60
Angled 60°
22 cm (8 3/4")

UltraCut™ TC DeBakey Vascular Scissor

Operating Scissors
 Chirurgische Scheren
 Tijeras quirúrgicas
 Ciseaux chirurgicaux
 Forbici per chirurgia

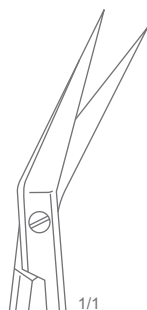

77-985-11
UltraCut™ TC Iris Scissor
 Angled
 Overall Length 11 cm (4 1/2")

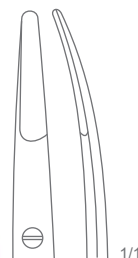

77-987-12
 12.5 cm (5")

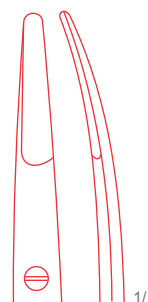

77-987-15
 15 cm (6")

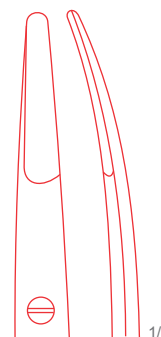

77-987-18
 18 cm (7")

UltraCut™ TC Ragnell (Kilner) Dissecting Scissor
 Curved

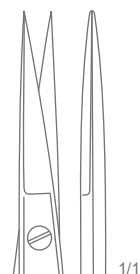

77-988-16
 Straight

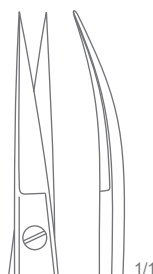

77-989-16
 Curved

UltraCut™ TC Kelly Dissecting Scissor
 Overall Length 16 cm (6 1/4")

Operating Scissors
Chirurgische Scheren
Tijeras quirúrgicas
Ciseaux chirurgicaux
Forbici per chirurgia

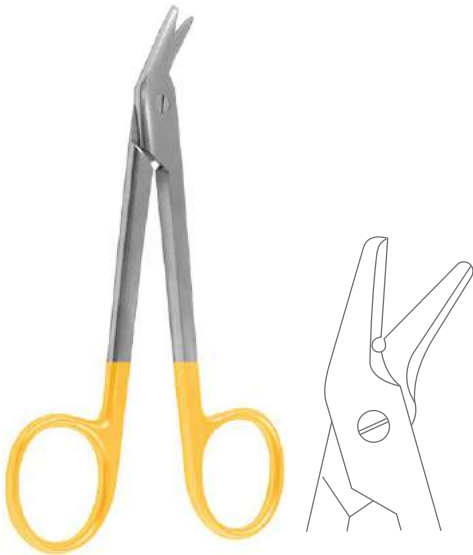

77-991-12

UltraCut™ TC Universal Wire Cutting Scissor
Angled One Toothed Cutting Edge
Overall Length 12.5 cm (5")



77-992-16

UltraCut™ TC Smith Wire Cutting Scissor
Angled One Toothed Cutting Edge
Overall Length 16 cm (6 1/4")



77-999-18

UltraCut™ TC Lister Bandage Scissor
Overall Length 18 cm (7")

Needle Holders
Nadelhalter
Porta-agujas
Porte-aiguilles
Portaghi



1/1

78-010-12
Derf Needle Holder
One Fenestrated Jaw
Overall Length 12 cm (4 3/4")



1/1

78-012-12
Converse Needle Holder
Jaw With Longitudinal Serrations
Overall Length 13 cm (5")



1/1

78-016-12
Collier Needle Holder
One Grooved Jaws
Overall Length 12.5 cm (5")



1/1

78-020-13
Webster Needle Holder
Smooth Jaws
Overall Length 13 cm (5")

Needle Holders
Nadelhalter
Porta-agujas
Porte-aiguilles
Portaghi

THORAX, CARDIOVASCULAR SURGERY



Halsey Needle Holder
Overall Length 13.5 cm (5 1/4")



78-024-13
Smooth Jaws

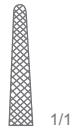

78-026-13
Serrated Jaws

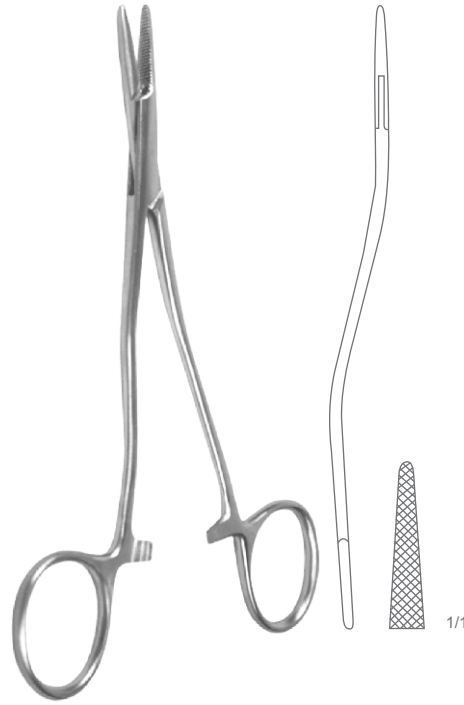

78-029-13
Kilner Needle Holder
Overall Length 13.5 cm (5 1/4")



78-032-13
Neivert Needle Holder
Smooth Jaws With Special Groove
Overall Length 12.5 cm (5")

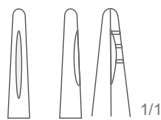

Needle Holders
Nadelhalter
Porta-agujas
Porte-aiguilles
Portaghi



78-038-14
Hegar-Baumgartner Needle Holder
Overall Length 14.5 cm (5 3/4")

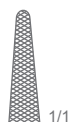

Brown Needle Holder
Heavy Pattern

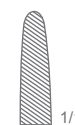

78-040-13
13 cm (5")



78-040-18
18 cm (7")



78-042-15
Lawrence Needle Holder
Overall Length 14.5 cm (5 3/4")



78-046-15
Crile-Murray Needle Holder
Slender Pattern
Overall Length 15 cm (6")

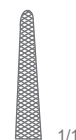

Needle Holders
Nadelhalter
Porta-agujas
Porte-aiguilles
Portaghi



78-050-15
15 cm (6")

78-050-18
18 cm (7")

78-050-20
20 cm (8")

Crile-Wood Needle Holder

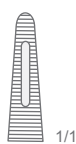
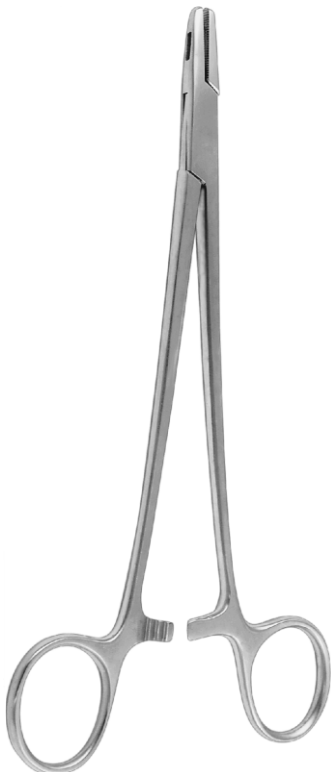

78-052-18
Adson Needle Holder
One Fenestrated Jaw
Overall Length 18 cm (7")

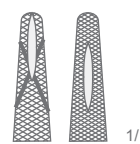
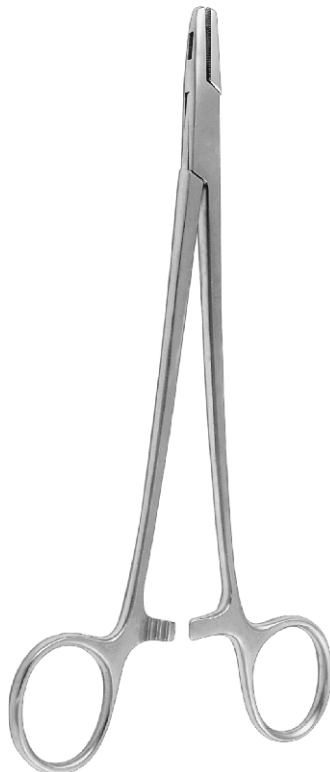

78-054-18
Metzenbaum Needle Holder
One Grooved and Fenestrated Jaws
Overall Length 18.5 cm (7 1/4")

Needle Holders
Nadelhalter
Porta-agujas
Porte-aiguilles
Portaghi



78-056-17
M.G. Hospital Needle Holder
Heavy Pattern
Overall Length 17.5 cm (7")



Mayo-Hegar Needle Holder

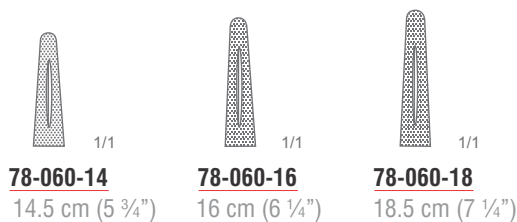

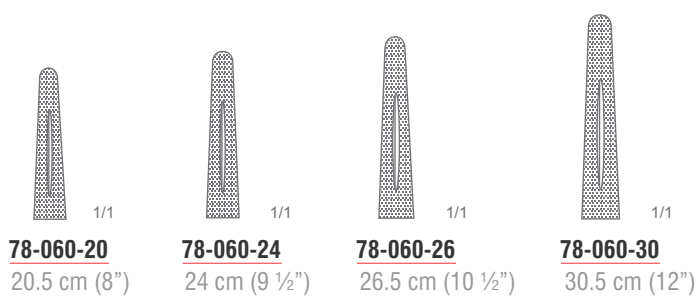

78-060-14 14.5 cm (5 3/4")
78-060-16 16 cm (6 1/4")
78-060-18 18.5 cm (7 1/4")



78-060-20 20.5 cm (8")
78-060-24 24 cm (9 1/2")
78-060-26 26.5 cm (10 1/2")
78-060-30 30.5 cm (12")

Needle Holders
Nadelhalter
Porta-agujas
Porte-aiguilles
Portaghi



- | | | |
|--|--|--|
|  |  |  |
| 1/1 | 1/1 | 1/1 |
| 78-062-16 | 78-062-18 | 78-062-20 |
| 16 cm (6 1/4") | 18.5 cm (7 1/4") | 20.5 cm (8") |

Mayo-Hegar (Delicate) Needle Holder
Slender Pattern



Discuss Omar Bhai

- | | |
|---|------------------|
|  | |
| 1/1 | |
| 78-068-18 | 78-068-26 |
| 18 cm (7") | 25.5 cm (10") |

Sarot Needle Holder

Needle Holders
Nadelhalter
Porta-agujas
Porte-aiguilles
Portaghi

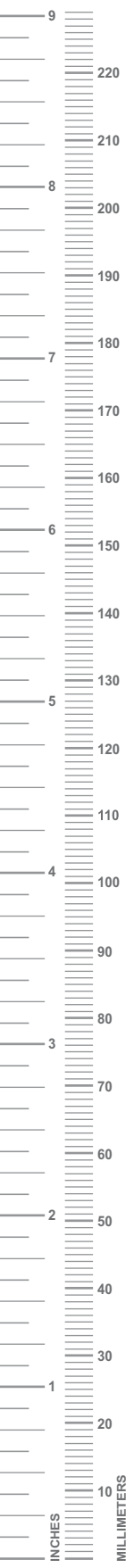

78-070-21
Heaney Needle Holder
Overall Length 20.5 cm (8")



78-072-23
Jameson Needle Holder
Overall Length 23.5 cm (9 1/4")

Needle Holders
Nadelhalter
Porta-agujas
Porte-aiguilles
Portaghi

THORAX, CARDIOVASCULAR SURGERY

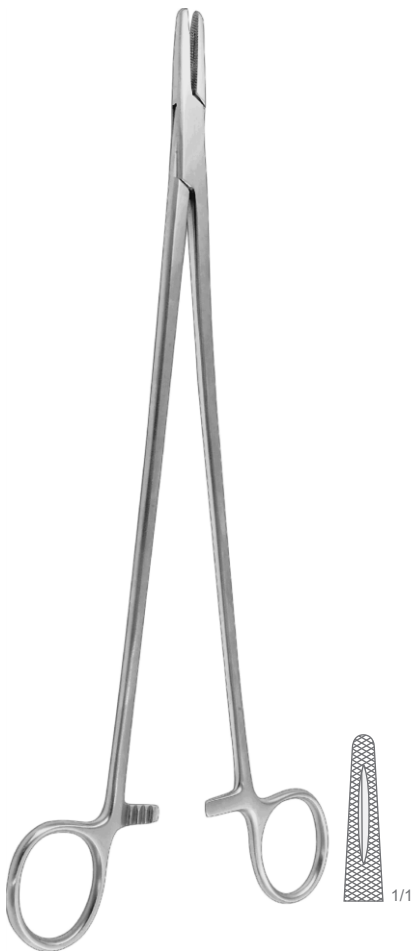

78-074-27
Masson Needle Holder
Overall Length 26.5 cm (10 1/2")



78-077-26
Masson-Luethy Needle Holder
Overall Length 25.5 cm (10")

Needle Holders
Nadelhalter
Porta-agujas
Porte-aiguilles
Portaghi



78-079-27
Finochietto Needle Holder
Overall Length 26.5 cm (10 1/2")



78-082-27
Wangensteen Needle Holder
Overall Length 26.5 cm (10 1/2")

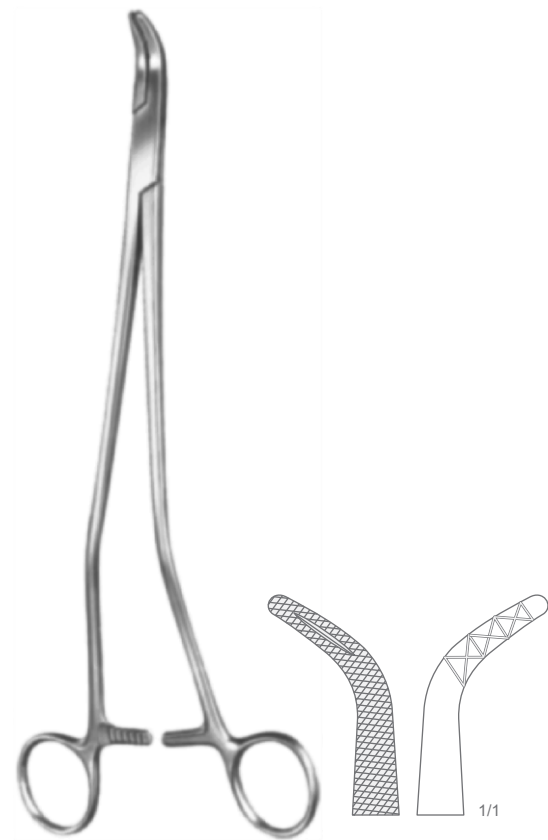

78-085-27
Johnson Needle Holder
Overall Length 27 cm (10 3/4")

Needle Holders
Nadelhalter
Porta-agujas
Porte-aiguilles
Portaghi



78-087-20
20 cm (8")

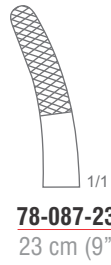

78-087-23
23 cm (9")



Stratte Needle Holder

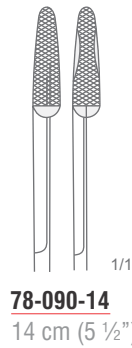

78-090-14
14 cm (5 1/2")

78-090-18
18.5 cm (7 1/4")



Olsen-Hegar Needle Holder

THORAX, CARDIOVASCULAR SURGERY

Micro Needle Holders
Mikro-Nadelhalter
Micro Porta-agujas
Micro porte-aiguilles
Micro Portaghi



78-094-16
Gillies Needle Holder
Overall Length 16 cm (6 1/4")



78-210-14
Straight

78-211-14
Curved

Castroviejo Micro Needle Holder
Delicate 1.0 x 12 mm Tips, Without Lock
Overall Length 14 cm (5 1/2")



78-212-14
Straight

78-213-14
Curved

Castroviejo Micro Needle Holder
Delicate 1.0 x 12 mm Tips, With Lock
Overall Length 14 cm (5 1/2")

Micro Needle Holders
Mikro-Nadelhalter
Micro Porta-agujas
Micro porte-aiguilles
Micro Portaghi

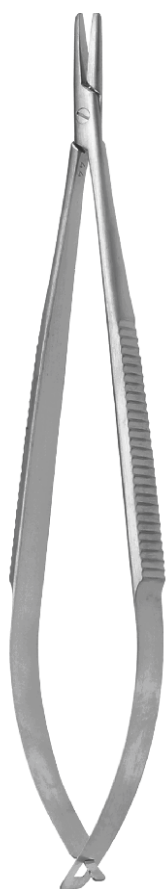

 1/1
78-220-14
Straight

 1/1
78-221-14
Curved

Castroviejo Micro Needle Holder

Standard 1.5 x 12 mm Tips, Without Lock
Overall Length 14 cm (5 1/2")



 1/1
78-222-14
Straight

 1/1
78-223-14
Curved

Castroviejo Micro Needle Holder

Standard 1.5 x 12 mm Tips, With Lock
Overall Length 14 cm (5 1/2")

Micro Needle Holders
Mikro-Nadelhalter
Micro Porta-agujas
Micro porte-aiguilles
Micro Portaghi

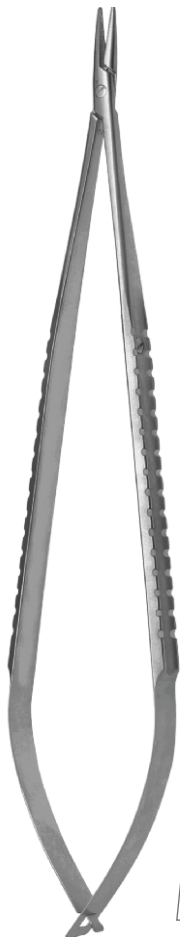

78-230-18
Jacobson Micro Needle Holder
Straight, Without Lock
Overall Length 18.5 cm (7 1/4")



78-231-18
Jacobson Micro Needle Holder
Straight, With Lock
Overall Length 18.5 cm (7 1/4")



78-234-21
Micro Needle Holder
Straight, With Lock
Overall Length 21 cm (8 1/4")

Micro Needle Holders
Mikro-Nadelhalter
Micro Porta-agujas
Micro porte-aiguilles
Micro Portaghi

THORAX, CARDIOVASCULAR SURGERY



78-246-14
Kalt Micro Needle Holder
Straight, With Lock
Overall Length 13.5 cm (5 1/4")

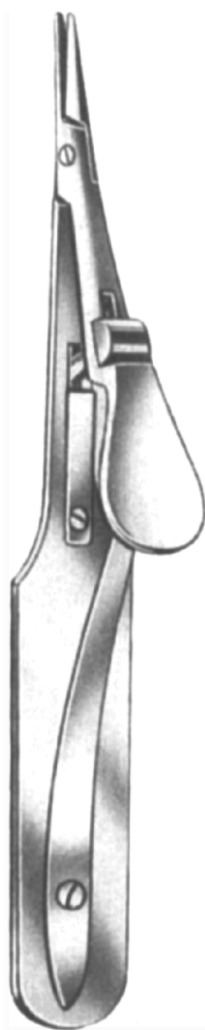

78-250-14
Straight

78-251-14
Curved

Arruga Micro Needle Holder
With Lock
Overall Length 13.5 cm (5 1/4")

Micro Needle Holders
Mikro-Nadelhalter
Micro Porta-agujas
Micro porte-aiguilles
Micro Portaghi



78-254-14
Silcock Micro Needle Holder
With Lock
Overall Length 14.5 cm (5 3/4")



Barraquer Micro Needle Holder
Very Delicate, Round Handle, Without Lock
Overall Length 13 cm (5")

78-320-13
Straight

78-321-13
Curved



78-322-13
Straight

78-323-13
Curved

Barraquer Micro Needle Holder
Very Delicate, Round Handle, With Lock
Overall Length 13 cm (5")

Micro Needle Holders
Mikro-Nadelhalter
Micro Porta-agujas
Micro porte-aiguilles
Micro Portaghi



78-331-14

Curved

78-332-14

Straight

Barraquer Micro Needle Holder

Very Delicate, Round Handle
Overall Length 14 cm (5 1/2")



78-331-14 T

Barraquer Micro Needle Holder

Curved, Very Delicate, Round Handle
Overall Length 14 cm (5 1/2")



78-333-14

Barraquer Micro Needle Holder

Curved, Very Delicate, Round Handle, With Lock
Overall Length 14 cm (5 1/2")



78-333-14 T

Barraquer Micro Needle Holder

Curved, Very Delicate, Round Handle, With Lock
Overall Length 14 cm (5 1/2")



Micro Needle Holders
Mikro-Nadelhalter
Micro Porta-agujas
Micro porte-aiguilles
Micro Portaghi

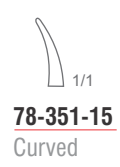

Reill Micro Needle Holder
Without Lock
Overall Length 15 cm (6")

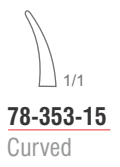

Reill Micro Needle Holder
With Lock
Overall Length 15 cm (6")

Micro Needle Holders
Mikro-Nadelhalter
Micro Porta-agujas
Micro porte-aiguilles
Micro Portaghi

 1/1

78-354-18
Straight

 1/1

78-355-18
Curved

 1/1

78-356-18
Straight

 1/1

78-357-18
Curved

Micro Needle Holder
Without Lock
Overall Length 18.5 cm (7 1/4")

Micro Needle Holder
With Lock
Overall Length 18.5 cm (7 1/4")

Micro Needle Holders
Mikro-Nadelhalter
Micro Porta-agujas
Micro porte-aiguilles
Micro Portaghi

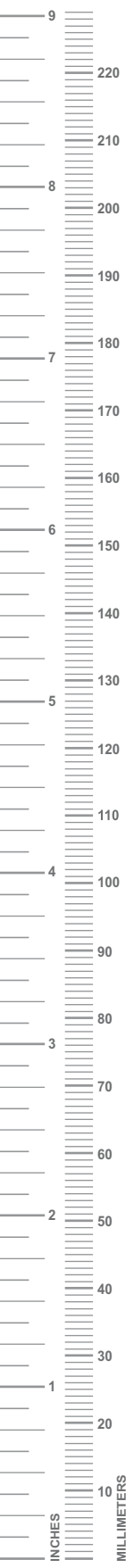

78-360-20
Micro Needle Holder
Straight, With Lock
Overall Length 20 cm (8")



78-362-23
Micro Needle Holder
Straight, Delicate, With Lock
Overall Length 23 cm (9")



Diam-n-Dust™ Micro Needle Holder
Straight, Without Lock
Overall Length 17 cm (6 3/4")



78-416-17



78-418-17



Micro Needle Holders
Mikro-Nadelhalter
Micro Porta-agujas
Micro porte-aiguilles
Micro Portaghi



78-420-14
14 cm (5 1/2")

78-420-18
18 cm (7")

78-420-21
21 cm (8 1/4")

78-420-23
23 cm (9")



Diam-n-Dust™ Micro Needle Holder
Straight, Without Lock



78-422-14
14 cm (5 1/2")

78-422-18
18 cm (7")

78-422-21
21 cm (8 1/4")

78-422-23
23 cm (9")



Diam-n-Dust™ Micro Needle Holder
Straight, With Lock

Micro Needle Holders
 Mikro-Nadelhalter
 Micro Porta-agujas
 Micro porte-aiguilles
 Micro Portaghi



78-430-12

12 cm (4 3/4")

78-430-14

14 cm (5 1/2")

78-430-16

16 cm (6 1/4")

78-430-18

18.5 cm (7 1/4")

78-430-21

21 cm (8 1/4")

78-430-23

23 cm (9")



Diam-n-GRIP

Diam-n-Dust™ Micro Needle Holder
 Straight, With Lock, Round Handle



78-431-14

14 cm (5 1/2")

78-431-18

18.5 cm (7 1/4")



Diam-n-GRIP

Diam-n-Dust™ Micro Needle Holder
 Curved, With Lock, Round Handle

Micro Needle Holders
 Mikro-Nadelhalter
 Micro Porta-agujas
 Micro porte-aiguilles
 Micro Portaghi



78-432-14
 14 cm (5 1/2")

78-432-16
 16 cm (6 1/4")

78-432-18
 18.5 cm (7 1/4")

78-432-21
 21 cm (8 1/4")

78-432-23
 23 cm (9")

78-432-25
 25 cm (9 3/4")



Diam-n-GRIP

Diam-n-Dust™ Micro Needle Holder
 Straight, With Lock, Round Handle



78-432-14 T
 14 cm (5 1/2")

78-432-16 T
 16 cm (6 1/4")

78-432-18 T
 18.5 cm (7 1/4")

78-432-21 T
 21 cm (8 1/4")

78-432-23 T
 23 cm (9")



TITANIUM

Diam-n-Dust™ Micro Needle Holder
 Straight, With Lock, Round Handle

Micro Needle Holders
 Mikro-Nadelhalter
 Micro Porta-agujas
 Micro porte-aiguilles
 Micro Portaghi



78-433-14
 14 cm (5 1/2")

78-433-18
 18.5 cm (7 1/4")

78-433-21
 21 cm (8 1/4")

78-432-23
 23 cm (9")



Diam-n-Dust™ Micro Needle Holder
 Curved, With Lock, Round Handle



78-433-14 T
 14 cm (5 1/2")

78-433-18 T
 18.5 cm (7 1/4")

78-433-21 T
 21 cm (8 1/4")

78-433-23 T
 23 cm (9")



Diam-n-Dust™ Micro Needle Holder
 Curved, With Lock, Round Handle

Micro Needle Holders
 Mikro-Nadelhalter
 Micro Porta-agujas
 Micro porte-aiguilles
 Micro Portaghi



78-434-18
 18.5 cm (7 ¼")

78-434-21
 21 cm (8 ¼")

78-434-23
 23 cm (9")



Diam-n-Dust™ Micro Needle Holder
 Straight, With Lock, Round Handle



78-435-18
 18.5 cm (7 ¼")

78-435-21
 21 cm (8 ¼")

78-435-23
 23 cm (9")



Diam-n-Dust™ Micro Needle Holder
 Curved, With Lock, Round Handle

Micro Needle Holders
 Mikro-Nadelhalter
 Micro Porta-agujas
 Micro porte-aiguilles
 Micro Portaghi



78-436-12
 12 cm (4 3/4")

78-436-16
 16 cm (6 1/4")

78-436-18
 18.5 cm (7 1/4")

Diam-n-Dust™ Micro Needle Holder
 Straight, Without Lock, Round Handle



78-437-18
 18.5 cm (7 1/4")

Diam-n-Dust™ Micro Needle Holder
 Curved, Without Lock, Round Handle



Micro Needle Holders
 Mikro-Nadelhalter
 Micro Porta-agujas
 Micro porte-aiguilles
 Micro Portaghi



78-438-14
 14 cm (5 1/2")

78-438-16
 16 cm (6 1/4")

78-438-18
 18.5 cm (7 1/4")

78-438-21
 21 cm (8 1/4")

78-438-23
 23 cm (9")



Diam-n-Dust™ Micro Needle Holder
 Straight, Without Lock, Round Handle



78-438-14 T
 14 cm (5 1/2")

78-438-16 T
 16 cm (6 1/4")

78-438-18 T
 18.5 cm (7 1/4")

78-438-21 T
 21 cm (8 1/4")

78-438-23 T
 23 cm (9")



Diam-n-Dust™ Micro Needle Holder
 Straight, Without Lock, Round Handle



Micro Needle Holders
 Mikro-Nadelhalter
 Micro Porta-agujas
 Micro porte-aiguilles
 Micro Portaghi



78-439-14
 14 cm (5 1/2")

78-439-18
 18.5 cm (7 1/4")

78-439-21
 21 cm (8 1/4")

78-439-23
 23 cm (9")

Diam-n-Dust™ Micro Needle Holder
 Curved, Without Lock, Round Handle



78-439-14 T
 14 cm (5 1/2")

78-439-18 T
 18.5 cm (7 1/4")

78-439-21 T
 21 cm (8 1/4")

78-439-23 T
 23 cm (9")

Diam-n-Dust™ Micro Needle Holder
 Curved, Without Lock, Round Handle



Micro Needle Holders
Mikro-Nadelhalter
Micro Porta-agujas
Micro porte-aiguilles
Micro Portaghi



1/1

78-440-19

19 cm (7 1/2")

78-440-23

23 cm (9")

78-440-25

25 cm (9 3/4")



Diam-n-GRIP

Diam-n-Dust™ Micro Needle Holder

Straight, Without Lock, Heavy Pattern, Round Handle



1/1

78-442-19

19 cm (7 1/2")

78-442-23

23 cm (9")

78-442-25

25 cm (9 3/4")



Diam-n-GRIP

Diam-n-Dust™ Micro Needle Holder

Straight, With Lock, Heavy Pattern, Round Handle



Micro Needle Holders
 Mikro-Nadelhalter
 Micro Porta-agujas
 Micro porte-aiguilles
 Micro Portaghi



Diam-n-Dust™ DeBakey Needle Holder

78-460-15
 15 cm (6")

78-460-18
 18 cm (7")

78-460-20
 20 cm (8")

78-460-23
 23 cm (9")



Diam-n-Dust™ Ryder Vascular Needle Holder

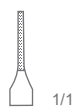

1/1

78-470-13
 13 cm (5")



1/1

78-470-15
 15 cm (6")

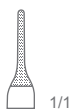

1/1

78-470-18
 18 cm (7")



1/1

78-470-22
 22 cm (8 3/4")

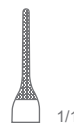

1/1

78-470-25
 25 cm (9 3/4")



Operating Scissors
 Chirurgische Scheren
 Tijeras quirúrgicas
 Ciseaux chirurgicaux
 Forbici per chirurgia

THORAX, CARDIOVASCULAR SURGERY

78-500-13

UltraGrip™ TC Barraquer Micro Needle Holder
 Curved, Smooth Jaws, Without Lock, Round Handle
 Overall Length 13 cm (5")

ULTRA GRIP[™]X

78-502-13

UltraGrip™ TC Barraquer Micro Needle Holder
 Curved, Smooth Jaws, With Lock, Round Handle
 Overall Length 13 cm (5")

ULTRA GRIP[™]X

Operating Scissors
 Chirurgische Scheren
 Tijeras quirúrgicas
 Ciseaux chirurgicaux
 Forbici per chirurgia

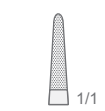

78-510-14
 Straight
 With Lock



78-512-14
 Straight
 With Lock
 Smooth Jaws



78-511-14
 Curved
 With Lock



78-513-14
 Curved
 With Lock
 Smooth Jaws

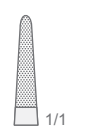

78-520-18
 Straight
 With Lock
 18 cm (7")



78-521-18
 Curved
 With Lock
 18 cm (7")

UltraGrip™ TC Castroviejo Micro Needle Holder
 With Lock
 Overall Length 14.5 (5 3/4")

UltraGrip™ TC Micro Needle Holder
 With Lock
 Overall Length 18 (7")



ULTRA GRIP X™



ULTRA GRIP X™

Operating Scissors
Chirurgische Scheren
Tijeras quirúrgicas
Ciseaux chirurgicaux
Forbici per chirurgia



78-530-21
Straight
With Lock

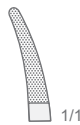

78-531-21
Curved
With Lock

UltraGrip™ TC Jacobson Micro Needle Holder
With Lock
Overall Length 21.5 cm (8 1/2")



ULTRA GRIP X™

THORAX, CARDIOVASCULAR SURGERY

Operating Scissors
Chirurgische Scheren
Tijeras quirúrgicas
Ciseaux chirurgicaux
Forbici per chirurgia



UltraGrip™ TC Diethrich Micro Needle Holder

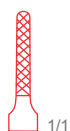

78-550-16
16 cm (6 1/4")

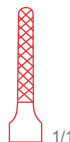

78-550-18
18 cm (7")

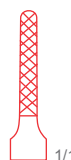

78-550-20
20 cm (8")

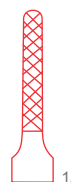

78-550-23
23 cm (9")

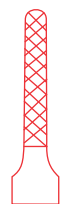

78-550-26
26 cm (10 1/2")



ULTRA GRIP X™

Operating Scissors
Chirurgische Scheren
Tijeras quirúrgicas
Ciseaux chirurgicaux
Forbici per chirurgia

THORAX, CARDIOVASCULAR SURGERY



78-573-13
UltraGrip™ TC Kilner Needle Holder
S Shaped
Overall Length 13 cm (5")

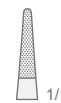

78-576-12
UltraGrip™ TC Derf Needle Holder
Overall Length 12 cm (4 3/4")



ULTRA GRIP™



ULTRA GRIP™

Operating Scissors
Chirurgische Scheren
Tijeras quirúrgicas
Ciseaux chirurgicaux
Forbici per chirurgia

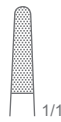

78-580-13
13 cm (5")

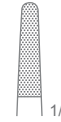

78-580-14
14.5 cm (5")



ULTRA GRIP

UltraGrip™ TC Hegar-Baumgartner Needle Holder



78-584-13
13 cm (5")
Smooth Jaws

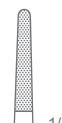

78-586-13
13 cm (5")



ULTRA GRIP

UltraGrip™ TC Halsey Needle Holder

Operating Scissors
Chirurgische Scheren
Tijeras quirúrgicas
Ciseaux chirurgicaux
Forbici per chirurgia

THORAX, CARDIOVASCULAR SURGERY



78-588-12
UltraGrip™ TC Webster Needle Holder
Smooth Jaw
Overall Length 12 cm (4 3/4")



78-590-12
UltraGrip™ TC Converse Needle Holder
Overall Length 12.5 cm (5")



ULTRA GRIP™



ULTRA GRIP™

Operating Scissors
 Chirurgische Scheren
 Tijeras quirúrgicas
 Ciseaux chirurgicaux
 Forbici per chirurgia

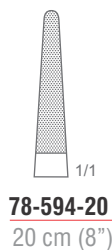
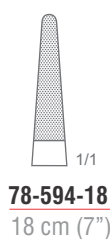
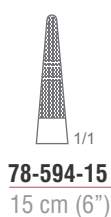

ULTRA GRIP X™

UltraGrip™ TC Crile-Wood Needle Holder

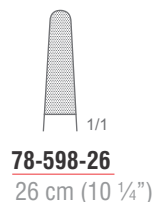
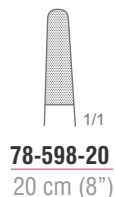
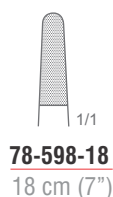

ULTRA GRIP X™

UltraGrip™ TC Sarot Needle Holder

Operating Scissors
 Chirurgische Scheren
 Tijeras quirúrgicas
 Ciseaux chirurgicaux
 Forbici per chirurgia



78-600-14
 14.5 cm (5 3/4")

78-600-16
 16 cm (6 1/4")

78-600-18
 18 cm (7")

78-600-20
 20 cm (8")

78-600-24
 24 cm (9 1/2")

78-600-26
 26 cm (10 1/4")

78-600-30
 30 cm (11 3/4")



ULTRA GRIP[™]

UltraGrip™ TC Mayo-Hegar Needle Holder



78-602-20
 20 cm (8")

78-602-24
 23.5 cm (9 1/4")



ULTRA GRIP[™]

UltraGrip™ TC Hegar Needle Holder

THORAX, CARDIOVASCULAR SURGERY

Operating Scissors
 Chirurgische Scheren
 Tijeras quirúrgicas
 Ciseaux chirurgicaux
 Forbici per chirurgia

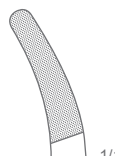
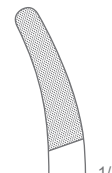
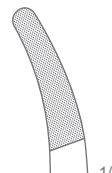

- | | | |
|--|--|--|
|  |  |  |
| 1/1 | 1/1 | 1/1 |
| 78-605-20 | 78-605-24 | 78-605-20 |
| 20 cm (8") | 24 cm (9 1/2") | 26 cm (10 1/4") |



ULTRA GRIP[™]

UltraGrip™ TC Heaney Needle Holder

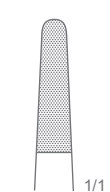
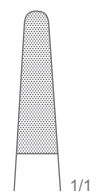
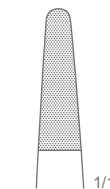
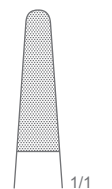

- | | |
|---|---|
|  |  |
| 1/1 | 1/1 |
| 78-611-20 | 78-611-20 |
| 20.5 cm (8") | 24 cm (9 1/2") |
|  |  |
| 1/1 | 1/1 |
| 78-611-26 | 78-611-28 |
| 26.5 cm (10 1/2") | 29 cm (11 1/2") |



ULTRA GRIP[™]

UltraGrip™ TC Bozemann Needle Holder

Operating Scissors
Chirurgische Scheren
Tijeras quirúrgicas
Ciseaux chirurgicaux
Forbici per chirurgia

78

THORAX, CARDIOVASCULAR SURGERY

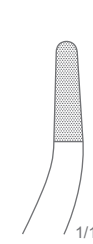

78-615-21
21 cm (8 1/4")

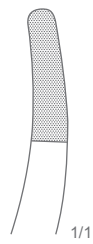

78-615-23
23 cm (9")

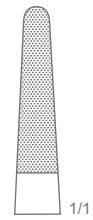

78-620-27
UltraGrip™ TC Masson Needle Holder
Overall Length 26.5 cm (10 1/2")



ULTRA GRIP X™



ULTRA GRIP X™

Operating Scissors
Chirurgische Scheren
Tijeras quirúrgicas
Ciseaux chirurgicaux
Forbici per chirurgia



78-624-27
UltraGrip™ TC Wangensteen Needle Holder
Overall Length 27 cm (10 3/4")



ULTRA GRIP™



78-625-27
UltraGrip™ TC Needle Holder
Overall Length 27 cm (10 3/4")



ULTRA GRIP™



78-627-27
UltraGrip™ TC Finochietto Needle Holder
Overall Length 26.5 cm (10 1/2")



ULTRA GRIP™

Operating Scissors
Chirurgische Scheren
Tijeras quirúrgicas
Ciseaux chirurgicaux
Forbici per chirurgia



78-630-26
UltraGrip™ TC Naunton-Morgan Needle Holder
Compound Action
Overall Length 26 cm (10 1/4")



ULTRA GRIP[™]

THORAX, CARDIOVASCULAR SURGERY



78-650-18
18 cm (7")

78-650-20
20 cm (8")

78-650-23
23 cm (9")

78-650-26
26 cm (10 1/4")

78-650-31
31 cm (12 1/4")



ULTRA GRIP[™]

UltraGrip™ TC DeBakey Needle Holder

Operating Scissors
 Chirurgische Scheren
 Tijeras quirúrgicas
 Ciseaux chirurgicaux
 Forbici per chirurgia



UltraGrip™ TC Ryder Needle Holder

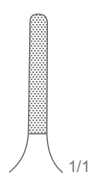

78-660-13
 12.5 cm (5")

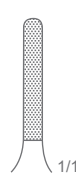

78-660-15
 15 cm (6")

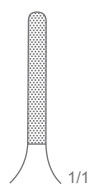

78-660-18
 18 cm (7")

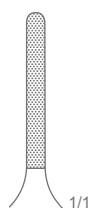

78-660-20
 20 cm (8")

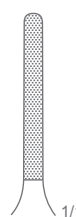

78-660-23
 23 cm (9")

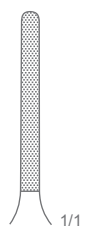

78-660-26
 26 cm (10 1/4")



ULTRA GRIP



UltraGrip™ TC Ryder-Vascular Needle Holder

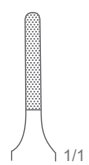

78-664-13
 12.5 cm (5")

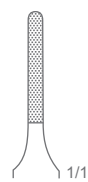

78-664-15
 15 cm (6")

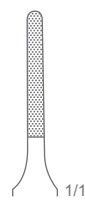

78-664-18
 18 cm (7")

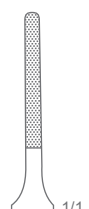

78-664-20
 20 cm (8")

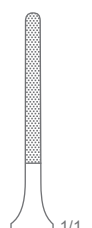

78-664-23
 22.5 cm (8 3/4")

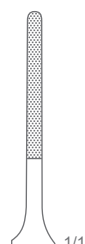

78-664-26
 26 cm (10 1/4")



ULTRA GRIP

Operating Scissors
 Chirurgische Scheren
 Tijeras quirúrgicas
 Ciseaux chirurgicaux
 Forbici per chirurgia

THORAX, CARDIOVASCULAR SURGERY

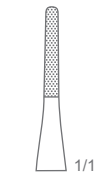

78-674-14
 14 cm (5 ½")

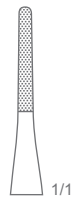

78-674-18
 18.5 cm (7 ¼")

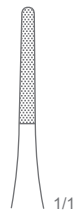

78-674-20
 20.5 cm (8")

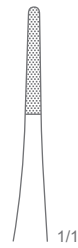

78-674-23
 23 cm (9")



ULTRA GRIP™

UltraGrip™ TC Hegar-Vascular Needle Holder

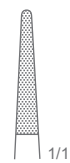

78-678-14
 14 cm (5 ½")

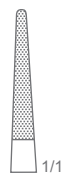

78-678-18
 18 cm (7")

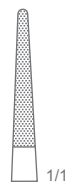

78-678-20
 20 cm (8")

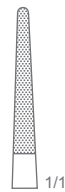

78-678-23
 23 cm (9")



ULTRA GRIP™

UltraGrip™ TC Micro Vascular Needle Holder

Operating Scissors
Chirurgische Scheren
Tijeras quirúrgicas
Ciseaux chirurgicaux
Forbici per chirurgia



UltraGrip™ TC Martini Needle Holder



ULTRA GRIP



1/1

78-680-14

Smooth Jaws
14 cm (5 1/2")



1/1

78-680-16

Smooth Jaws
16 cm (6 1/4")



1/1

78-680-18

Smooth Jaws
18 cm (7")



1/1

78-680-20

Smooth Jaws
20 cm (8")

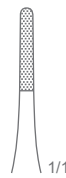

1/1

78-682-14

14 cm (5 1/2")

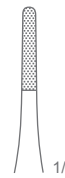

1/1

78-682-16

16 cm (6 1/4")

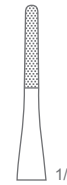

1/1

78-682-18

18 cm (7")

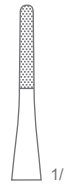

1/1

78-688-20

20 cm (8")

Operating Scissors
Chirurgische Scheren
Tijeras quirúrgicas
Ciseaux chirurgicaux
Forbici per chirurgia

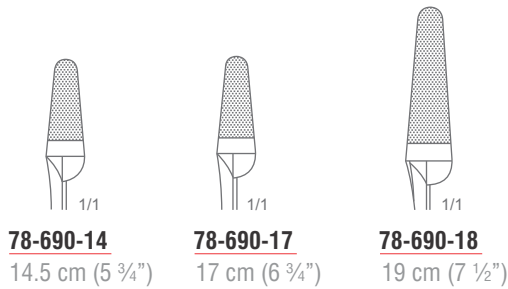

78-690-14
14.5 cm (5 3/4")

78-690-17
17 cm (6 3/4")

78-690-18
19 cm (7 1/2")



ULTRA GRIP

UltraGrip™ TC Olsen-Hegar Needle Holder

THORAX, CARDIOVASCULAR SURGERY



78-693-11
UltraGrip™ TC Foster-Gillies Needle Holder
Smooth Jaws
Overall Length 11 cm (4 1/4")



78-695-15
UltraGrip™ TC Gillies-Mini Needle Holder
Overall Length 15 cm (6")

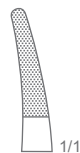
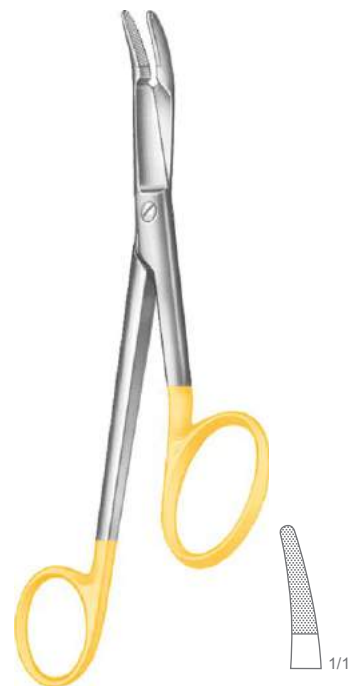

78-697-16
UltraGrip™ TC Gillies Needle Holder
Overall Length 16 cm (6 1/4")



Operating Scissors
Chirurgische Scheren
Tijeras quirúrgicas
Ciseaux chirurgicaux
Forbici per chirurgia



78-751-25
Ligature Clip Applier
For Small Clips
Overall Length 15 cm (6")



Ligature Clip Applier
For Small Clips
Overall Length 20 cm (8")



78-753-25
Angled 25°



78-753-65
Angled 65°

Operating Scissors
Chirurgische Scheren
Tijeras quirúrgicas
Ciseaux chirurgicaux
Forbici per chirurgia

THORAX, CARDIOVASCULAR SURGERY



Ligature Clip Applier
For Small Clips
Overall Length 28 cm (11")

78-755-25
Angled 25°

78-755-65
Angled 65°

Operating Scissors
Chirurgische Scheren
Tijeras quirúrgicas
Ciseaux chirurgicaux
Forbici per chirurgia



78-761-25
Ligature Clip Applier
For Medium Clips
Overall Length 15 cm (6")



Ligature Clip Applier
For Medium Clips
Overall Length 20 cm (8")



Operating Scissors
Chirurgische Scheren
Tijeras quirúrgicas
Ciseaux chirurgicaux
Forbici per chirurgia

THORAX, CARDIOVASCULAR SURGERY



78-765-25
Angled 25°



78-765-65
Angled 65°

Ligature Clip Applier
For Medium Clips
Overall Length 28 cm (11")

Operating Scissors
Chirurgische Scheren
Tijeras quirúrgicas
Ciseaux chirurgicaux
Forbici per chirurgia



Ligature Clip Applier
For Medium Clips
Overall Length 20 cm (8")



78-773-25
Angled 25°



78-773-65
Angled 65°



78-773-90
Angled 90°

Operating Scissors
Chirurgische Scheren
Tijeras quirúrgicas
Ciseaux chirurgicaux
Forbici per chirurgia

THORAX, CARDIOVASCULAR SURGERY



Ligature Clip Applier
For Small Clips
Overall Length 28 cm (11")



78-775-25
Angled 25°



78-775-65
Angled 65°



78-775-90
Angled 90°

Operating Scissors
Chirurgische Scheren
Tijeras quirúrgicas
Ciseaux chirurgicaux
Forbici per chirurgia



Ligature Clip Applier
For Medium Clips
Overall Length 20 cm (8")



78-783-25
Angled 25°



78-783-65
Angled 65°



78-783-90
Angled 90°

Operating Scissors
Chirurgische Scheren
Tijeras quirúrgicas
Ciseaux chirurgicaux
Forbici per chirurgia

78

THORAX, CARDIOVASCULAR SURGERY



Ligature Clip Applier
For Medium Clips
Overall Length 28 cm (11")



78-785-25
Angled 25°



78-785-65
Angled 65°



78-785-90
Angled 90°



Operating Scissors
Chirurgische Scheren
Tijeras quirúrgicas
Ciseaux chirurgicaux
Forbici per chirurgia



78-831-00

Young Ligature Needle Holder Complete

With Needle Ref: 78-831-01

Overall Length 24.5 cm (9 3/4")



78-831-01

Fig. 1

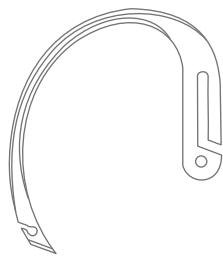

78-831-02

Fig. 2

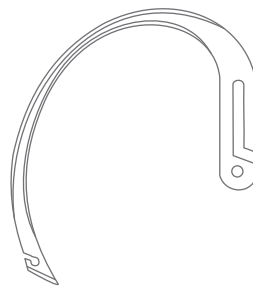

78-831-03

Fig. 3

Operating Scissors
 Chirurgische Scheren
 Tijeras quirúrgicas
 Ciseaux chirurgicaux
 Forbici per chirurgia

THORAX, CARDIOVASCULAR SURGERY

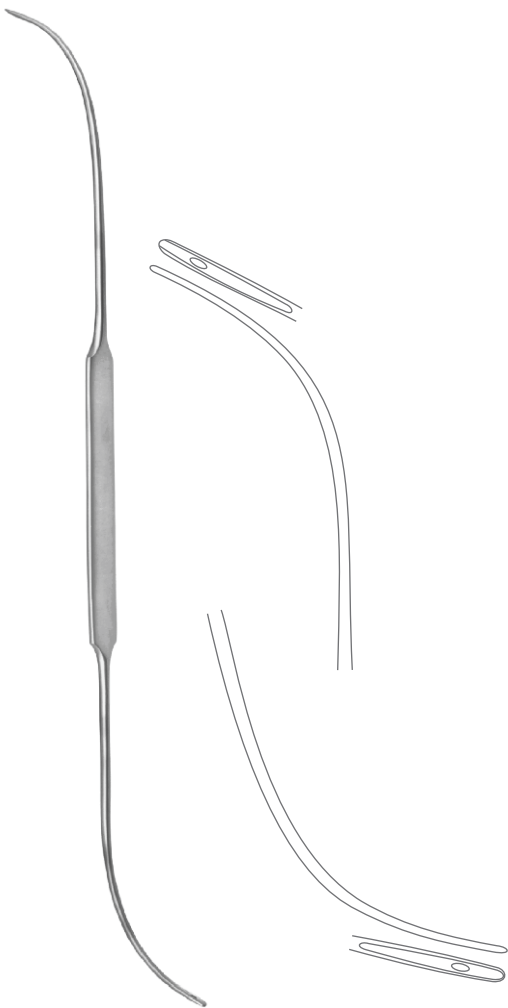

78-835-32
Schmieden-Dick Ligature Needle
 Malleable
 Overall Length 29 cm (11 1/2")

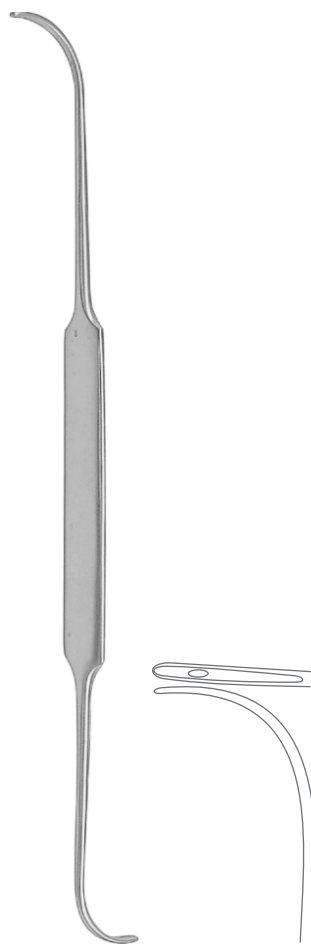

78-837-21
Schmieden Ligature Needle
 Overall Length 24 cm (9 1/2")



78-841-20
Ligature Needle
 Malleable
 Overall Length 20.5 cm (8")



Ligature Needles
 Unterbindungsnaedeln
 Aguja para ligaduras
 Aiguilles à ligatures
 Aghi per legatura

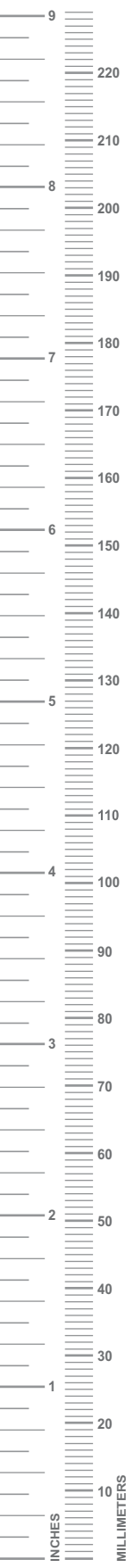

78-843-18
Jonesco Ligature Needle
 Overall Length 18.5 cm (7 1/4")



78-845-25
Claus Van Eicken Ligature Needle
 Overall Length 25 cm (9 3/4")

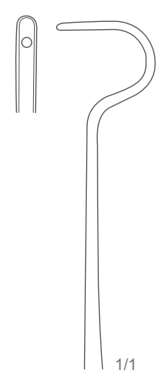

78-849-15
Ligature Needle
 Overall Length 15 cm (6")

Ligature Needles
 Unterbindungsnadeln
 Agujas para ligaduras
 Aiguilles à ligatures
 Aghi per legatura

THORAX, CARDIOVASCULAR SURGERY

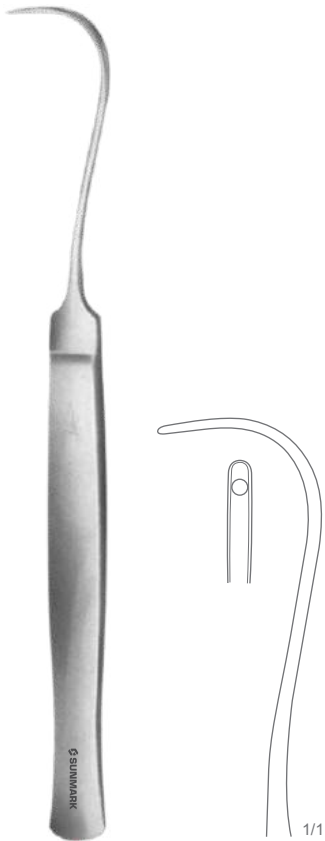

78-851-17
Syme Ligature Needle
 Overall Length 17 cm (6 3/4")



78-853-19
Cooper Ligature Needle
 Overall Length 18.5 cm (7 1/4")

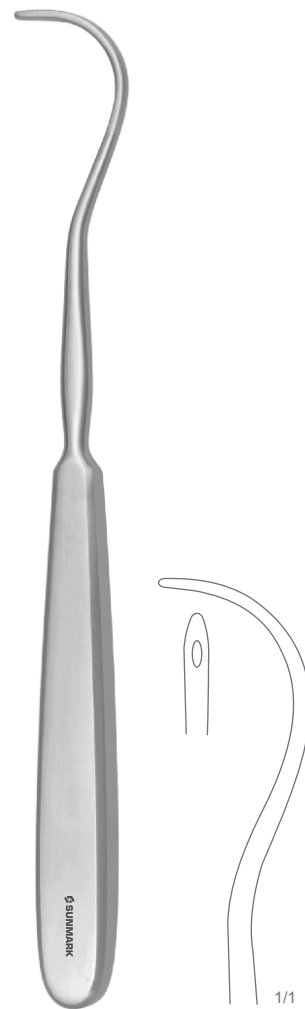

78-855-20
Kocher Ligature Needle
 Overall Length 20.5 cm (8")



Ligature Needles
Unterbindungsnaedeln
Agujas para ligaduras
Aiguilles à ligatures
Aghi per legatura



78-861-13
Right Hand

Kronecker Ligature Needle
Delicate
Overall Length 12.5 cm (5")



78-863-13
Left Hand

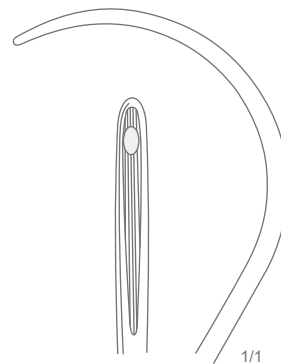

78-871-24
Right Hand

Deschamps Ligature Needle
Blunt
Overall Length 24 cm (9 1/2")

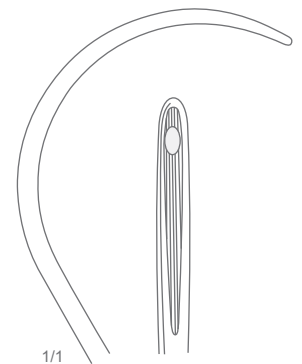

78-873-24
Left Hand

Ligature Needles
Unterbindungsnadeln
Agujas para ligaduras
Aiguilles à ligatures
Aghi per legatura

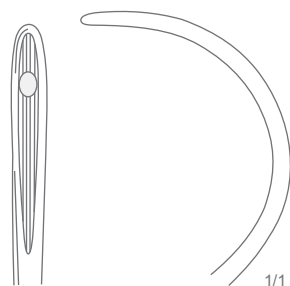

78-875-20
Right Hand

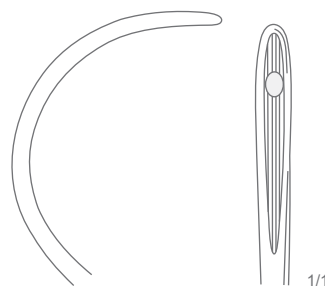

78-877-20
Left Hand

Deschamps Ligature Needle

Blunt
Overall Length 20 cm (8")

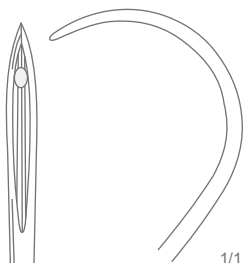

78-879-20
Left Hand

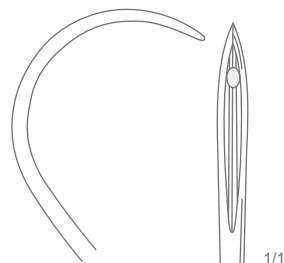

78-881-20
Left Hand

Deschamps Ligature Needle

Sharp
Overall Length 20 cm (8")

Ligature Needles
Unterbindungsadeln
Agujas para ligaduras
Aiguilles à ligatures
Aghi per legatura

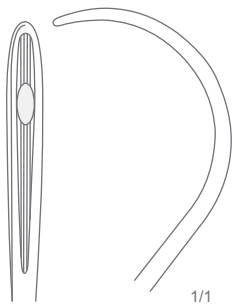

78-883-21
Right Hand

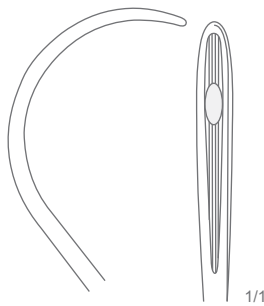

78-885-21
Left Hand

Deschamps Ligature Needle
Blunt
Overall Length 20 cm (8")



78-887-20
Right Hand



78-889-20
Left Hand

Deschamps Ligature Needle
Sharp
Overall Length 20 cm (8")

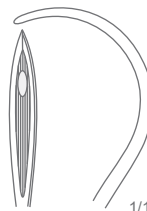

78-891-21
Right Hand

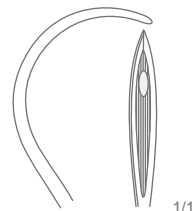

78-893-21
Right Hand

Deschamps Ligature Needle
Sharp
Overall Length 20 cm (8")

Ligature Needles
 Unterbindungsnadeln
 Agujas para ligaduras
 Aiguilles à ligatures
 Aghi per legatura

THORAX, CARDIOVASCULAR SURGERY

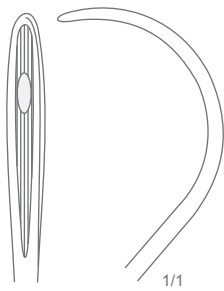

78-895-27
Blunt, Right Hand

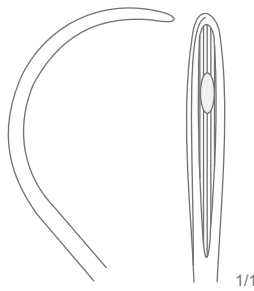

78-897-27
Blunt, Left Hand

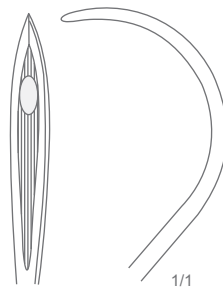

78-901-27
Sharp, Right Hand

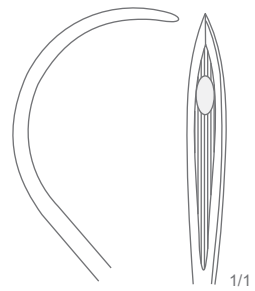

78-903-27
Sharp, Left Hand

Deschamps Ligature Needle
 Overall Length 27 cm (10 3/4")



Ligature Needles
 Unterbindungsnaedeln
 Aguja para ligaduras
 Aiguilles à ligatures
 Aghi per legatura

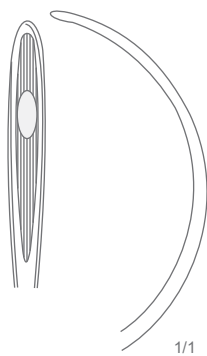
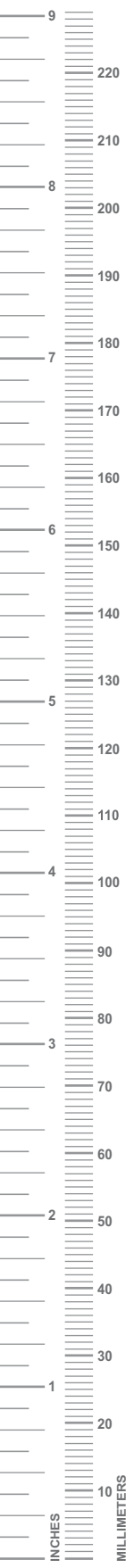

78-905-28
Right Hand

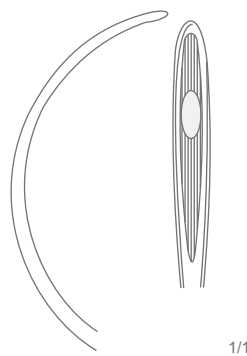

78-907-28
Left Hand

Deschamps Ligature Needle
 Blunt
 Overall Length 28 cm (11")

Ligature Needles
Unterbindungsnadeln
Agujas para ligaduras
Aiguilles à ligatures
Aghi per legatura

THORAX, CARDIOVASCULAR SURGERY



78-911-20
Right Hand

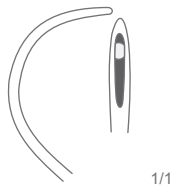

78-913-20
Left Hand

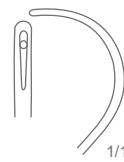

78-915-20
Right Hand

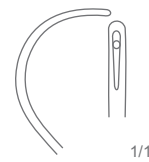

78-917-20
Left Hand

Deschamps Ligature Needle
Sharp
Overall Length 20 cm (8")

Deschamps Ligature Needle
Blunt
Overall Length 20 cm (8")

Ligature Needles
Unterbindungsnadeln
Agujas para ligaduras
Aiguilles à ligatures
Aghi per legatura



78-921-20
Right Hand

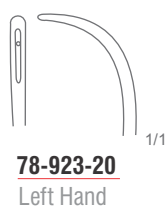

78-923-20
Left Hand

Deschamps Ligature Needle
Blunt
Overall Length 21 cm (8 1/4")



78-927-21
Right Hand

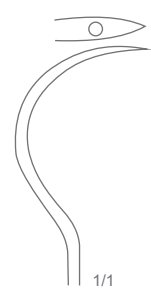

78-929-21
Left Hand

Hurd Ligature Needle
Sharp
Overall Length 20.5 cm (8")

Ligature Needles
 Unterbindungsnadeln
 Agujas para ligaduras
 Aiguilles à ligatures
 Aghi per legatura

THORAX, CARDIOVASCULAR SURGERY

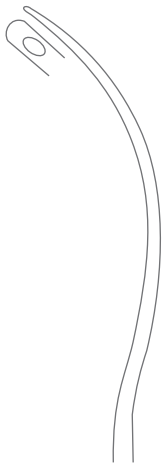

78-931-01

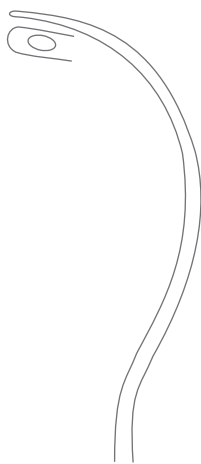

78-931-02

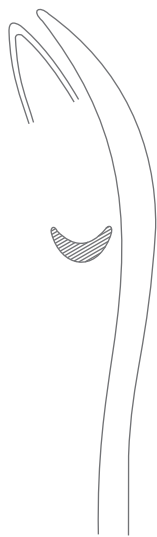

78-931-03



78-931-04

Brunner Ligature Needle

Overall Length 30 cm (11 3/4")



Ligature Needles
Unterbindungsnaedeln
Agujas para ligaduras
Aiguilles à ligatures
Aghi per legatura

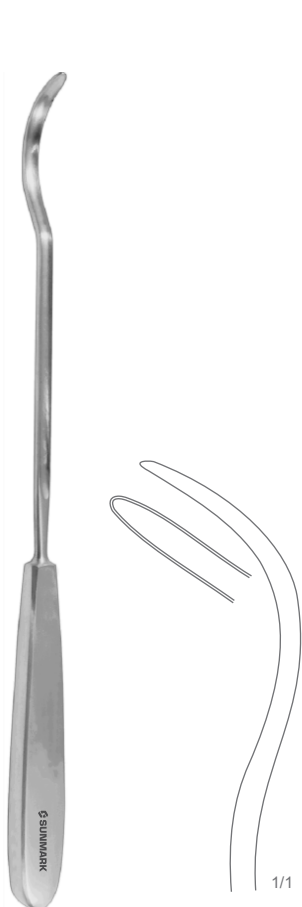

78-935-25
Kirschner Ligature Needle
Overall Length 25.5 cm (10")

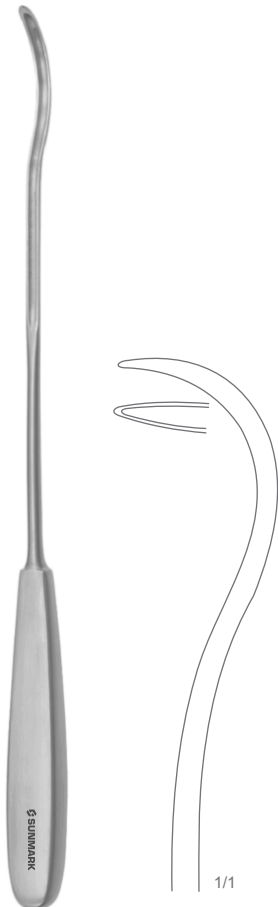

78-937-28
Ligature Needle
Overall Length 28 cm (11")

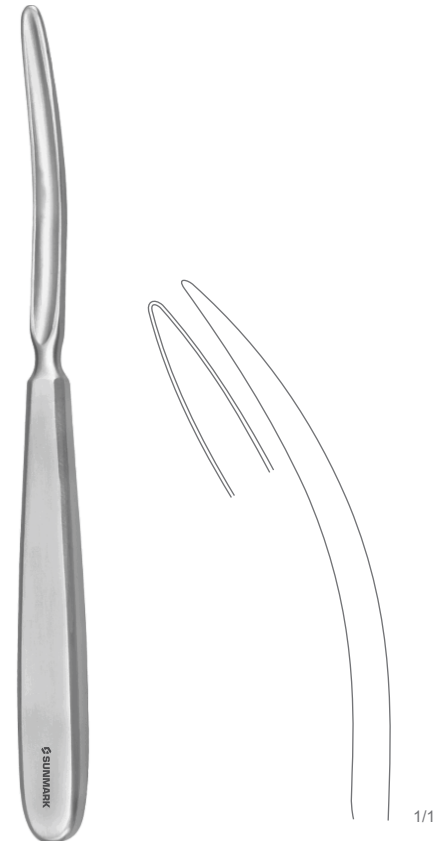

78-939-25
Martin Ligature Needle
Overall Length 19.5 cm (7 3/4")

Ligature Needles
Unterbindungsnadeln
Agujas para ligaduras
Aiguilles à ligatures
Aghi per legatura

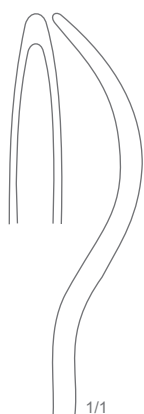

78-951-19
Without Eye



78-953-19
With Eye



78-955-03



78-955-05



78-955-07

Schmieden Ligature Needle
Overall Length 18 cm (8")

Schmieden Ligature Needle
Overall Length 19.5 cm (7 3/4")

Ligature Needles, Ligature Conductors
 Unterbindungsadeln, Führungshohlsonden
 Aguja para ligaduras, Sondas conductoras
 Aiguilles à ligatures, Sondes conductrices
 Aghi per legatura, Sonde conduttrici

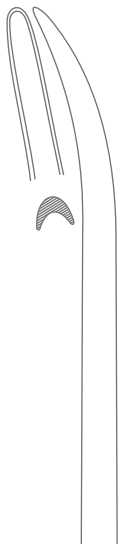

78-957-22

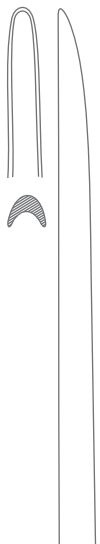

78-959-22

Payr Ligature Needle
 Overall Length 22 cm (8 3/4")



78-961-23
Modell Wien Ligature Catcher
 Overall Length 23.5 cm (9 1/4")



78-963-21
Bozemann Knot Tier
 Overall Length 21 cm (8 1/4")

Ligature Conductors
Führungshohlsonden
Sondas conductoras
Sondes conductrices
Sonde conduttrici



78-965-23
Ligature Adjuster
Overall Length 23 cm (9")



78-967-23
Caspar Ligature Adjuster
Bayonet Shaped
Overall Length 23 cm (9")



78-969-24
Millin Ligature Holding Forcep
Overall Length 24 cm (9 1/2")

Clip Applying Forceps
Wundklammerpinzetten, Wundklammerzängchen
Pinzas aplicadoras para agrafes
Pincas à poser les agrafes
Pinze per applicare le agrafe



78-980-18
Childe Approximation Forcep
Heavy Pattern With Clip Holder
Overall Length 17.5 cm (7")



78-984-12
Michel Clip Applying Forcep
Overall Length 12 cm (4 3/4")



78-986-12
Hegenbarth Clip Applying Forcep
Overall Length 12 cm (4 3/4")

Clip Applying Forceps
Wundklammerpinzetten, Wundklammerzängchen
Pinzas aplicadoras para agrafes
Pincas à poser les agrafes
Pinze per applicare le agrafe

THORAX, CARDIOVASCULAR SURGERY



1/1

78-988-12
Wachenfeldt Clip Applying Forcep
Overall Length 12 cm (4 ¾")



1/1

78-990-12
Michel Clip Applying & Removing Forcep
For Applying and Removal of Clips
Overall Length 12.5 cm (5")



1/1

78-992-12
Michel Clip Applying & Removing Forcep
Long Jaws For Applying and Removal of Clips
Overall Length 13 cm (5")

Clip Applying Forceps
 Wundklammerpinzetten, Wundklammerzängchen
 Pinzas aplicadoras para agrafes
 Pinces à poser les agrafes
 Pinze per applicare le agrafe



78-994-13
Collin Clip Applying Forcep
 With Screw Lock
 Overall Length 13 cm (5")

78-995-14
Clip Applying Forcep
 Overall Length 14 cm (5 1/2")

Clip Applying Forceps
Wundklammerpinzetten, Wundklammerzängchen
Pinzas aplicadoras para agrafes
Pinces à poser les agrafes
Pinze per applicare le agrafe

THORAX, CARDIOVASCULAR SURGERY



78-997-14
Richter Clip Applying Forcep
With Screw Lock
Overall Length 13.5 cm (5 1/4")

Scalpel Handles
Skalpellgriffe
Mangos de bisturios
Manches pour bistouris
Manici per bisturi

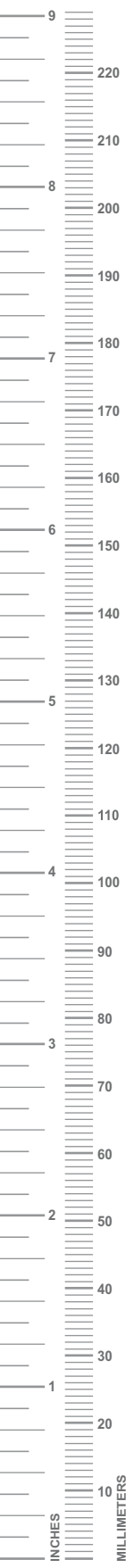

75-010-03
Scalpel Handle # 3
Solid
Overall Length 12 cm (4 3/4")



75-010-04
Scalpel Handle # 4
Solid
Overall Length 13.5 cm (5 1/4")



75-012-03
Scalpel Handle # 3
Solid, CM Graduation
Overall Length 12 cm (4 3/4")

Scalpel Handles
Skalpgriffe
Mangos de bisturíes
Manches pour bistouris
Manici per bisturi



1/2

75-020-13

Scalpel Handle # 3L

Solid, Long

Overall Length 21.5 cm (8 1/2")



1/2

75-020-14

Scalpel Handle # 4L

Solid, Long

Overall Length 21 cm (8 1/4")



1/2

75-021-13

Scalpel Handle # 3L

Solid, Angled, Long

Overall Length 21 cm (8 1/4")

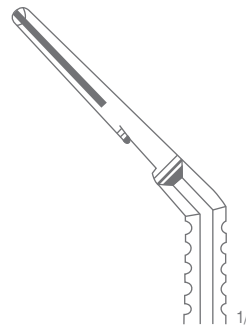

Scalpel Handles
Skalpellgriffe
Mangos de bisturios
Manches pour bistouris
Manici per bisturi

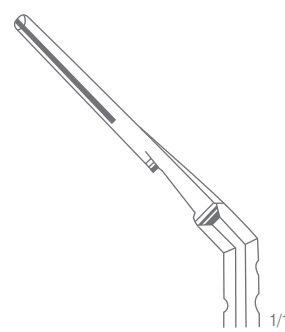
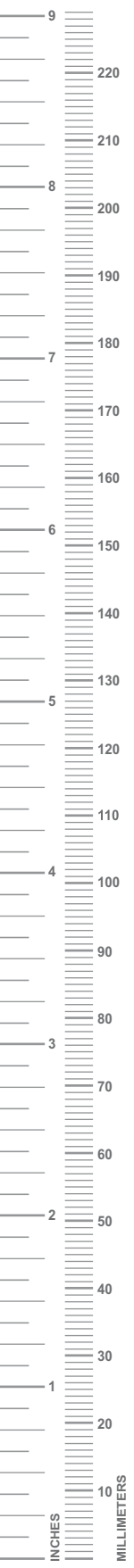

75-021-14
Scalpel Handle # 4L
Solid, Angled, Long
Overall Length 21 cm (8 1/4")



75-030-07
Scalpel Handle # 7
Solid, Also Known as 5
Overall Length 16 cm (6 1/4")



75-030-17
Scalpel Handle # 7K
Solid, Short
Overall Length 12.5 cm (5")



75-032-08
Collin Scalpel Handle # 8
With Hollow Handle
Overall Length 13.5 cm (5 1/4")

Scalpel Handles
Skalpgriffe
Mangos de bisturíes
Manches pour bistouris
Manici per bisturi

75

THORAX, CARDIOVASCULAR SURGERY



1/1

75-032-09
Collin Scalpel Handle # 9
With Hollow Handle
Overall Length 14.5 cm (5 3/4")



1/1

75-050-03
Scalpel Handle # 3
With Round Hollow Handle
Overall Length 15.5 cm (6")



1/1

75-052-03
Scalpel Handle # 3
With Round Handle
Overall Length 14.5 cm (5 3/4")



1/1

75-053-03
Scalpel Handle # 3
Solid, Round Handle, Angled
Overall Length 14 cm (5 1/2")

Scalpel Handles
Skalpellgriffe
Mangos de bisturios
Manches pour bistouris
Manici per bisturi



1/1

75-056-03
Kaye Scalpel Handle # 3
Solid, Round Handle
Overall Length 15 cm (6")



Scalpel Blades
 Skalpellslingen
 Hojas de bisturís
 Lames pour bistouris
 Lame per bisturi

Scalpel Blades
 Pack of 100



75-100-10
 Fig. 10



75-100-11
 Fig. 11

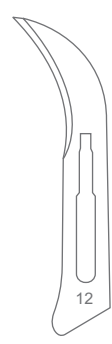

75-100-12
 Fig. 12



75-100-13
 Fig. 13



75-100-15
 Fig. 15

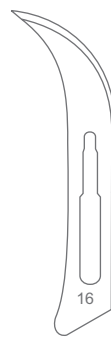

75-100-16
 Fig. 16

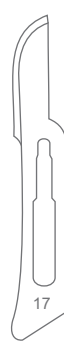

75-100-17
 Fig. 17



75-100-18
 Fig. 18

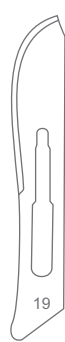

75-100-19
 Fig. 19

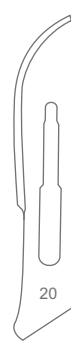

75-100-20
 Fig. 20



75-100-21
 Fig. 21



75-100-22
 Fig. 22



75-100-23
 Fig. 23

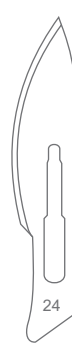

75-100-24
 Fig. 24



75-100-34
 Fig. 34

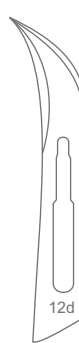

75-100-12
 Fig. 12D

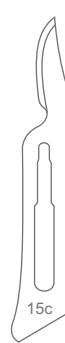

75-101-15
 Fig. 15C



75-100-36
 Fig. 36

Scalpel Handles
Skalpellgriffe
Mangos de bisturios
Manches pour bistouris
Manici per bisturi



75-202-00
Scalpel Handle
For Micro Scalpel Blades
Overall Length 13.5 cm (5 1/4")



75-204-00
Caspar Scalpel Handle
Overall Length 13.5 cm (5 1/4")



Beaver Scalpel Handle
For Micro Scalpel Blades

75-206-10 10 cm (4")
75-206-13 13 cm (5")
75-206-15 15 cm (6")

Scalpel Blades
Skalpellklingen
Hojas de bisturíes
Lames pour bistouris
Lame per bisturi

Scalpel Micro Blades
Pack of 25



75-210-61
Fig. 61



75-210-62
Fig. 62



75-210-63
Fig. 63



75-210-64
Fig. 64



75-210-65
Fig. 65



75-210-66
Fig. 66



75-210-67
Fig. 67



75-210-68
Fig. 68



75-210-69
Fig. 69



Karp Aorta Punch
Mikro-Nadelhalter
Micro Porta-agujas
Micro porte-aiguilles
Micro Portaghi

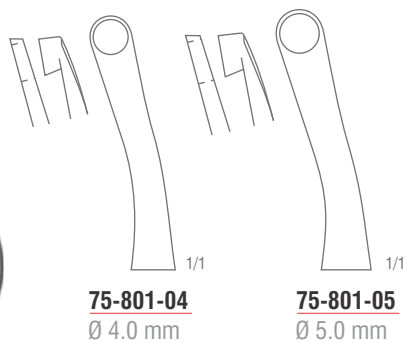

75-801-04
Ø 4.0 mm

75-801-05
Ø 5.0 mm

75-801-04
Karp Aorta Punch
Overall Length 16 cm (6 1/4")

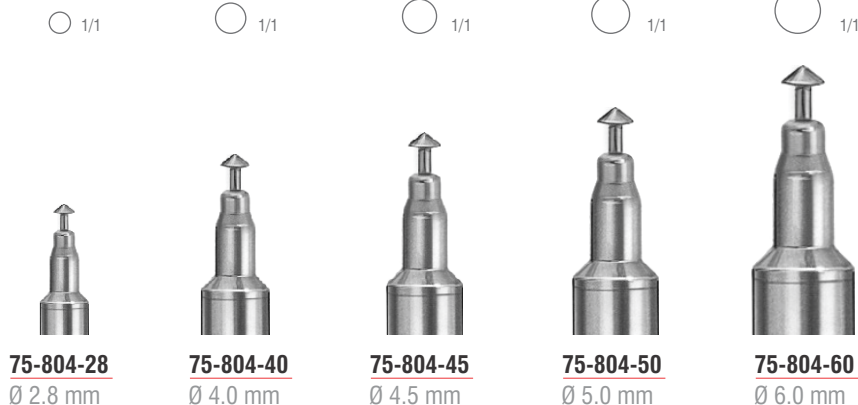

75-804-28
Ø 2.8 mm

75-804-40
Ø 4.0 mm

75-804-45
Ø 4.5 mm









75-804-50
Ø 5.0 mm

75-804-60
Ø 6.0 mm

Aorta Punch
Overall Length 14 cm (5 1/2")









Dressing Forcep
 Dissecting Forceps
 Anatomische Pinzetten
 Pinzas de disección
 Pincès à dissection

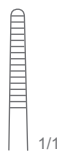

 1/1	 1/1	 1/1	 1/1	 1/1
37-010-10 10.5 cm (4 1/4")	37-010-11 11.5 cm (4 1/2")	37-010-13 13 cm (5")	37-010-14 14.5 cm (5 3/4")	37-010-16 16 cm (6 1/4")
 1/1	 1/1	 1/1	 1/1	 1/1
37-010-18 18 cm (7")	37-010-20 20 cm (8")	37-010-23 23 cm (9")	37-010-25 25 cm (9 3/4")	37-010-30 30.5 cm (12")

Standard Pattern Dressing Forcep
 Straight, Serrated



 1/1	 1/1	 1/1	 1/1	 1/1
37-012-11 12 cm (4 3/4")	37-012-13 13 cm (5")	37-012-14 14.5 cm (5 3/4")	37-012-16 16 cm (6 1/4")	37-012-18 18 cm (7")
 1/1	 1/1	 1/1	 1/1	
37-012-20 20 cm (8")	37-012-23 23 cm (9")	37-012-25 25 cm (9 3/4")	37-012-30 30 cm (11 3/4")	

Standard Pattern Dressing Forcep
 Straight, Serrated

Dressing Forcep
 Dissecting Forceps
 Anatomische Pinzetten
 Pinzas de disección
 Pincas à dissection

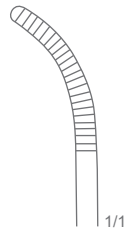

37-013-13
 13 cm (5")

37-013-14
 14 cm (5 1/2")

37-013-16
 16 cm (6 1/4")

Slender Pattern Dressing Forcep
 Curved, Serrated



37-016-13
 13 cm (5")



37-016-14
 14.5 cm (5 3/4")

37-016-16
 13 cm (5")

37-016-18
 18 cm (7")

37-016-20
 18 cm (8")

Fine Pattern Dressing Forcep
 Curved, Serrated

Dressing Forcep
Dissecting Forceps
Anatomische Pinzetten
Pinzas de disección
Pincas à dissection

THORAX, CARDIOVASCULAR SURGERY



37-030-15
Stille Dressing Forcep
Round Tips
Overall Length 15 cm (6")

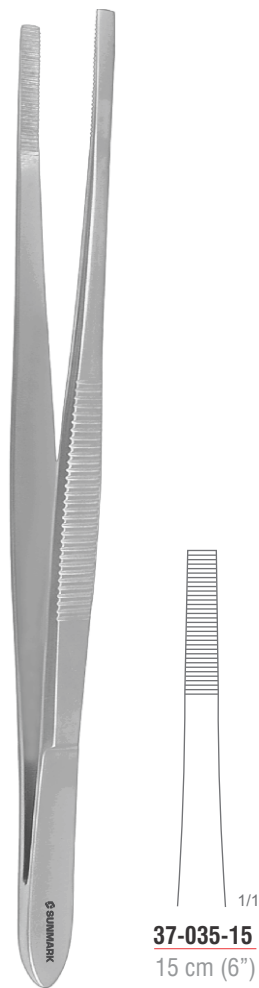

37-035-15
15 cm (6")

Stille Dressing Forcep
Square Tips

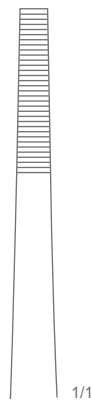

37-035-17
17 cm (6 3/4")

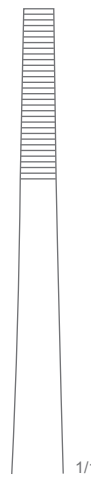

37-035-20
20 cm (8")

Dressing Forcep
Dissecting Forceps
Anatomische Pinzetten
Pinzas de disección
Pincas à dissection

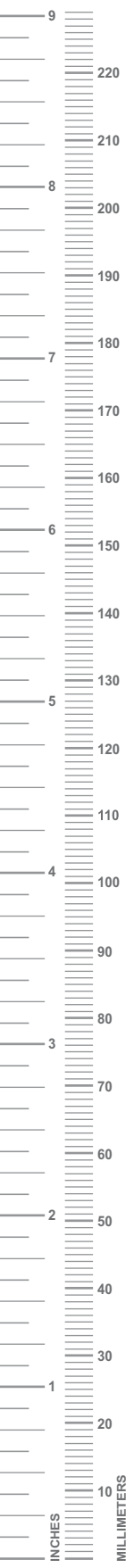

37-040-15
Treves Dressing Forcep
Cross Serrated Tips
Overall Length 15 cm (6")

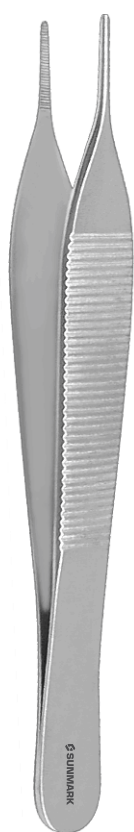

Adson Dressing Forcep

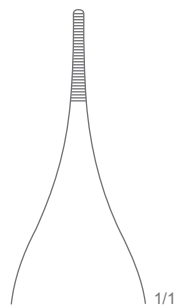

37-050-12
12 cm (4 3/4")

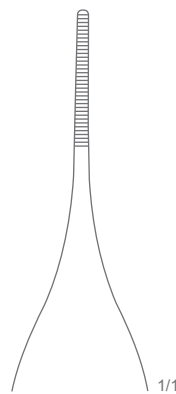

37-050-15
15 cm (6")

37-050-18
18 cm (7")

Dressing Forcep
Dissecting Forceps
Anatomische Pinzetten
Pinzas de disección
Pincas à dissection



Curved Linework
Required

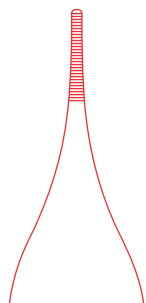

37-051-12
Adson Dressing Forcep
Curved
Overall Length 12 cm (4 3/4")

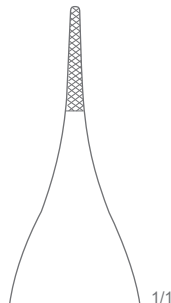
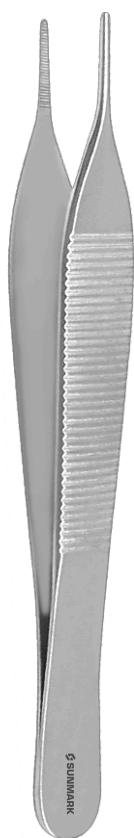

37-052-12
Mini Adson Dressing Forcep
Cross Serrated Tips
Overall Length 12 cm (4 3/4")

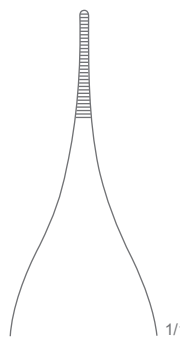

37-054-12
12 cm (4 3/4")

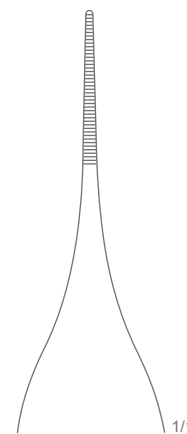

37-054-15
15 cm (6")

Micro Adson Dressing Forcep

Dressing Forcep
 Dissecting Forceps
 Anatomische Pinzetten
 Pinzas de disección
 Pincas à dissection

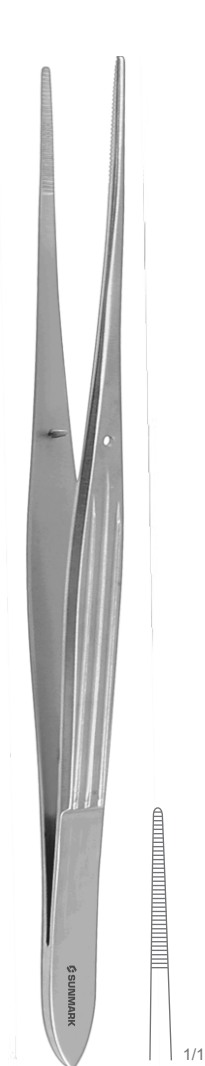

37-060-15
McIndoe Dressing Forcep
 Overall Length 15 cm (6")



Semken Dressing Forcep

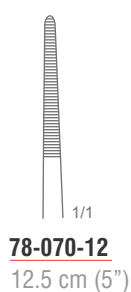

78-070-12
 12.5 cm (5")

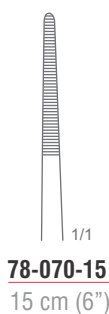

78-070-15
 15 cm (6")



37-074-17
Taylor Dressing Forcep
 Overall Length 17 cm (6 3/4")



37-076-17
Taylor Dressing Forcep
 With Dissector End
 Overall Length 17 cm (6 3/4")

Dressing Forcep
Dissecting Forceps
Anatomische Pinzetten
Pinzas de disección
Pincas à dissection

THORAX, CARDIOVASCULAR SURGERY



37-078-17
Taylor Dressing Forcep
Bayonet Shaped, With Dissector End
Overall Length 18.5 cm (7 1/4")



Turner Micro Dressing Forcep
Overall Length 15.5 cm (6")

37-080-06
0.6 mm

37-080-08
0.8 mm

37-080-10
1.0 mm

Dressing Forcep
Dissecting Forceps
Anatomische Pinzetten
Pinzas de disección
Pincas à dissection

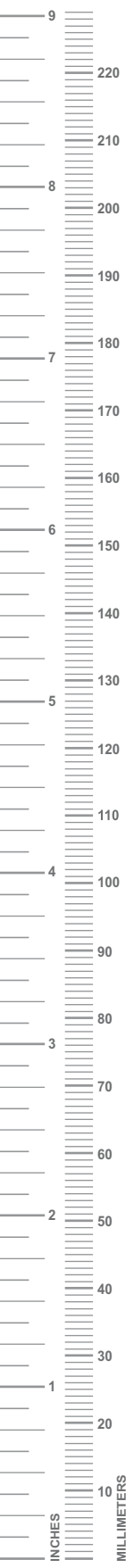

37-084-17
17.5 cm (7")

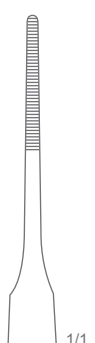

1/1

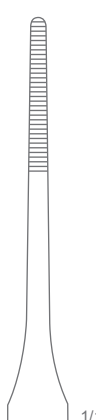

1/1

37-084-23
23 cm (9")



37-085-17
Gerald Dressing Forcep
Curved
Overall Length 17.5 cm (7")

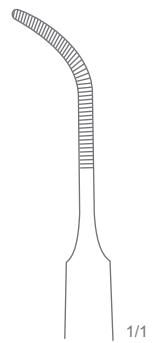

1/1

Dressing Forcep
Dissecting Forceps
Anatomische Pinzetten
Pinzas de disección
Pincas à dissection

THORAX, CARDIOVASCULAR SURGERY

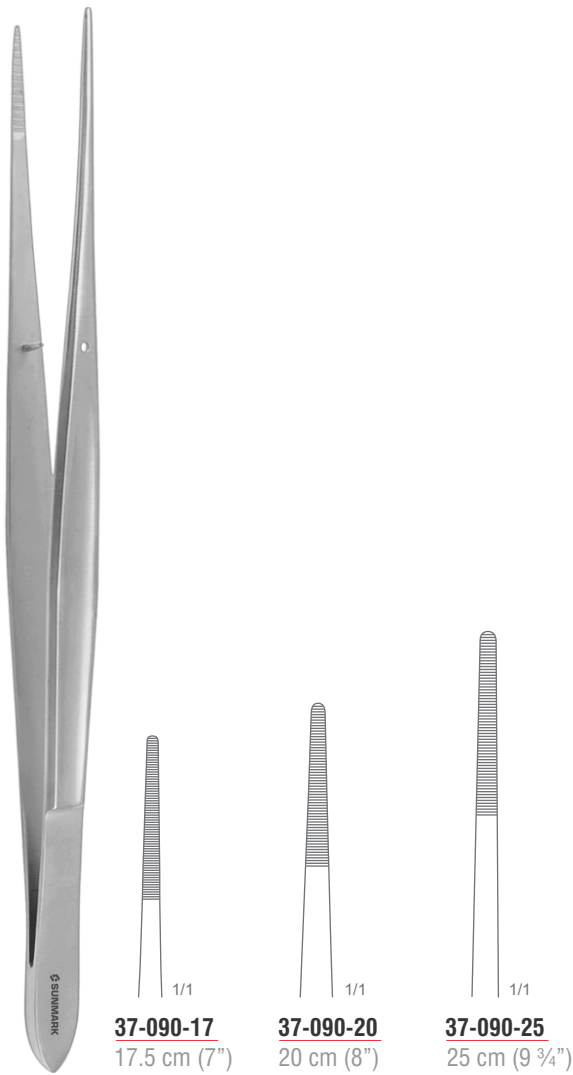

Cushing Dressing Forcep
Straight



37-091-17
Cushing Dressing Forcep
Curved
Overall Length 17.5 cm (7")

Dressing Forcep
Dissecting Forceps
Anatomische Pinzetten
Pinzas de disección
Pincas à dissection

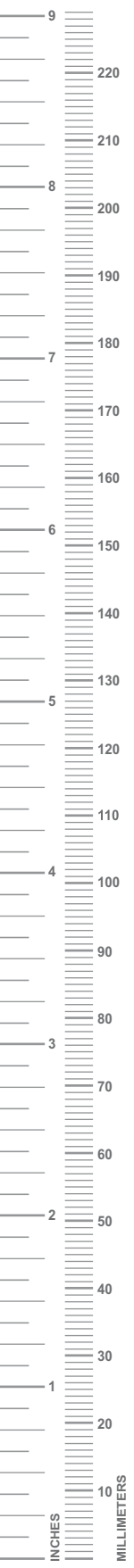

Potts-Smith Dressing Forcep

37-094-18
18 cm (7")



37-094-21
21 cm (8 1/4")



37-094-25
24.5 (9 3/4")

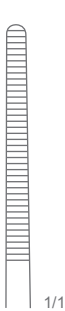

37-094-30
30 cm (11 3/4")



37-096-15
Dressing Forcep
Overall Length 15.5 cm (6")

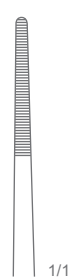

Dressing Forcep
Dissecting Forceps
Anatomische Pinzetten
Pinzas de disección
Pincas à dissection

THORAX, CARDIOVASCULAR SURGERY

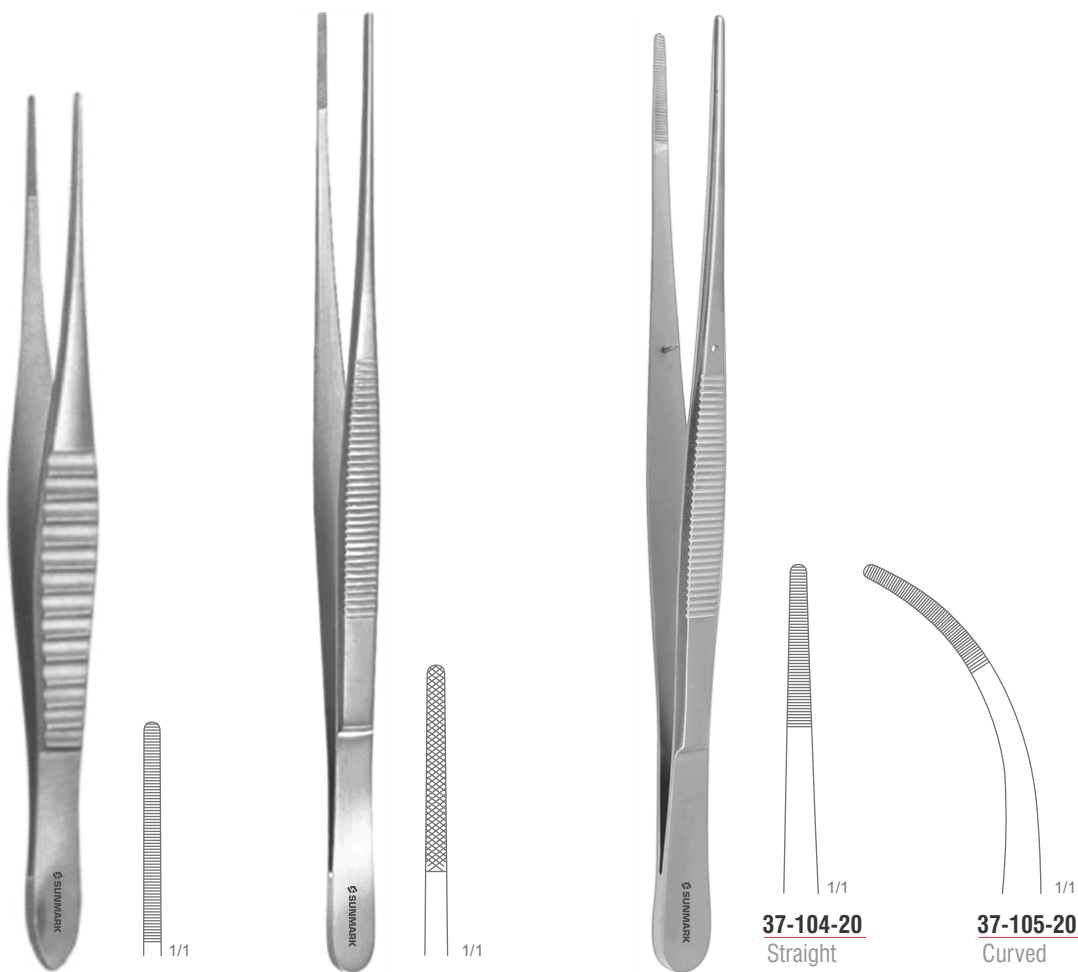

37-100-15
Gillies Dressing Forcep
Overall Length 15 cm (6")

37-102-20
Waugh Dressing Forcep
Cross Serrated
Overall Length 20 cm (8")

Brophy Dressing Forcep
Overall Length 20 cm (8")

37-104-20
Straight

37-105-20
Curved

Dressing Forcep
Dissecting Forceps
Anatomische Pinzetten
Pinzas de disección
Pincas à dissection

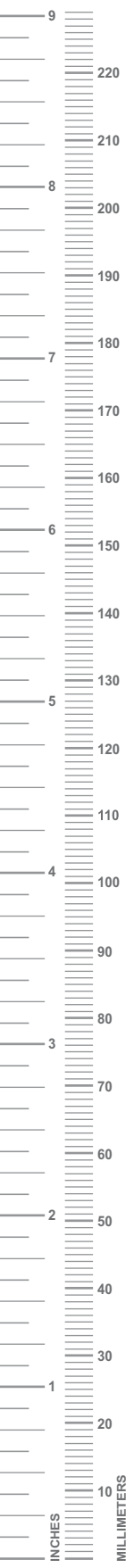

37-108-20
Cooley Dressing Forcep
Cross Serrated Jaws
Overall Length 20 cm (8")



37-111-20
Dressing Forcep
Angled
Overall Length 20 cm (8")

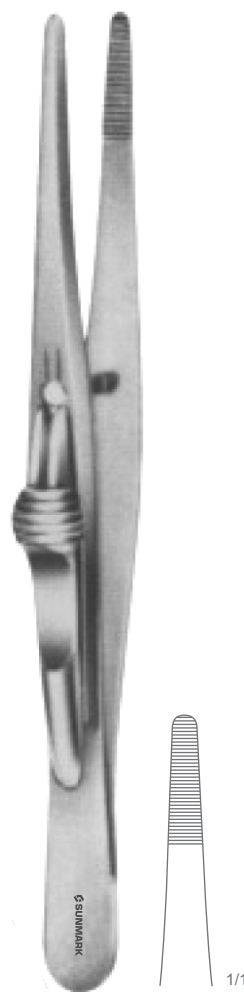

37-112-13
Fricke Ligature Forcep
With Lock
Overall Length 13 cm (5")

Dressing Forcep
Dissecting Forceps
Anatomische Pinzetten
Pinzas de disección
Pincas à dissection

THORAX, CARDIOVASCULAR SURGERY

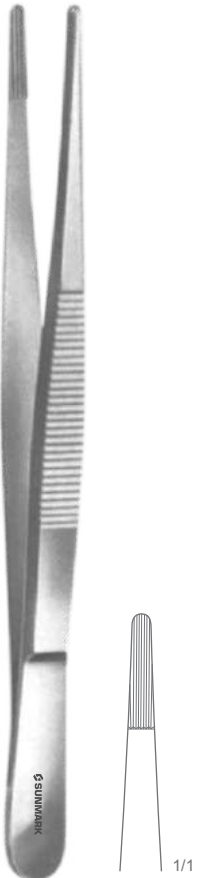

37-114-14
Ochsner Dressing Forcep
Longitudinal Serrations
Overall Length 14.5 cm (5 3/4")



37-116-17
Bonney Dressing Forcep
Overall Length 17.5 cm (7")











37-118-18
Ramsey Dressing Forcep
Overall Length 18 cm (7")

Dissecting Forceps
 Anatomische Pinzetten
 Pinzas de disección
 Pinces à dissection
 Pinze per dissezione



Standard Pattern Dissecting Forcep
 Straight, 1 x 2 Teeth



 37-200-10 10.5 cm (4 1/4")	 37-200-11 11.5 cm (4 1/2")	 37-200-13 13 cm (5")	 37-200-14 14.5 cm (5 3/4")	 37-200-16 16 cm (6 1/4")
 37-200-18 18 cm (7")	 37-200-20 20 cm (8")	 37-200-23 23 cm (9")	 37-200-25 25 cm (9 3/4")	 37-200-30 30.5 cm (12")



Standard Pattern Dissecting Forcep
 Straight, 2 x 3 Teeth



 37-202-11 12 cm (4 3/4")	 37-202-13 13 cm (5")	 37-202-14 14.5 cm (5 3/4")	 37-202-16 15.5 cm (6")
 37-202-18 18 cm (7")	 37-202-20 20 cm (8")	 37-202-25 24.5 cm (9 3/4")	

Dissecting Forceps
 Anatomische Pinzetten
 Pinzas de disección
 Pincès à dissection
 Pinze per dissezione

THORAX, CARDIOVASCULAR SURGERY

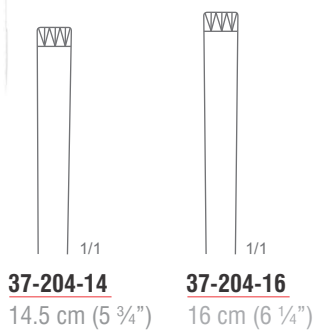

Standard Pattern Dissecting Forcep
 Straight, 3 x 4 Teeth

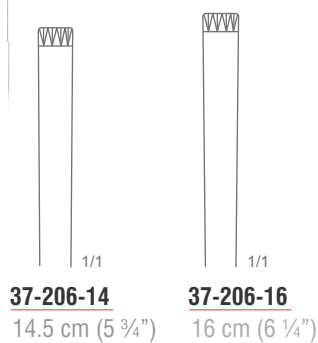

Standard Pattern Dissecting Forcep
 Straight, 4 x 5 Teeth



Dissecting Forceps
 Anatomische Pinzetten
 Pinzas de disección
 Pinces à dissection
 Pinze per dissezione

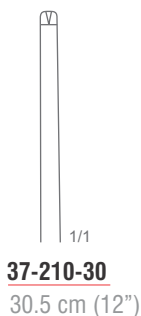
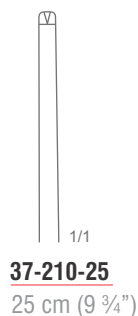
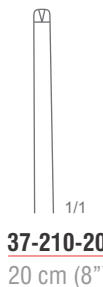
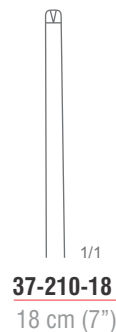
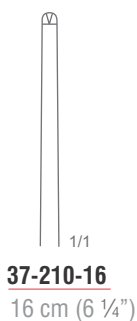
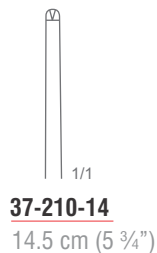
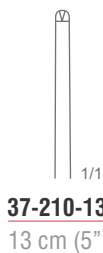

Standard Pattern Dissecting Forcep
 Straight, 1 x 2 Teeth

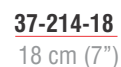
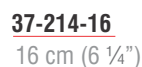
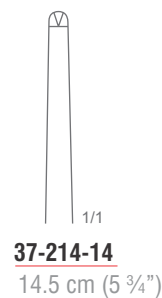
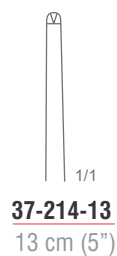
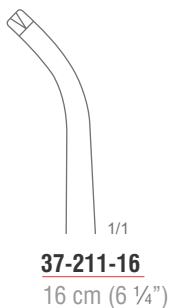
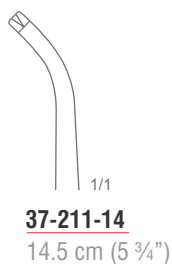

Standard Pattern Dissecting Forcep
 Straight, 1 x 2 Teeth



Fine Pattern Dissecting Forcep
 Straight, 1 x 2 Teeth



Dissecting Forceps
Anatomische Pinzetten
Pinzas de disección
Pincers à dissection
Pinze per dissezione

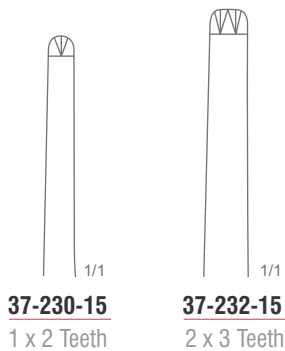

37-230-15
1 x 2 Teeth

Stille Dissecting Forcep
Overall Length 15 cm (6")



1:2

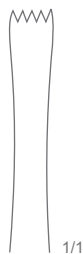

37-232-15
2 x 3 Teeth

37-234-15
Stone Dressing Forcep
Overall Length 15 cm (5 3/4")



4:5

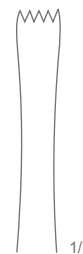

37-236-15
Lerche Dressing Forcep
Overall Length 15 cm (6")



5:6



Dissecting Forceps
Anatomische Pinzetten
Pinzas de disección
Pincès à dissection
Pinze per dissezione



37-240-15
15.5 cm (6")

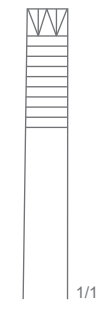

37-240-20
20.5 cm (8")



37-242-15
16 cm (6 1/4")

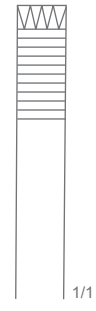

37-242-20
20 cm (8")

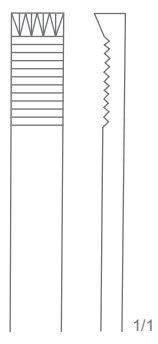

37-242-25
25 cm (9 3/4")

Adlerkreutz Dissecting Forcep
2 x 3 Teeth



Adlerkreutz Dissecting Forcep
4 x 5 Teeth



Dissecting Forceps
Anatomische Pinzetten
Pinzas de disección
Pincès à dissection
Pinze per dissezione

THORAX, CARDIOVASCULAR SURGERY

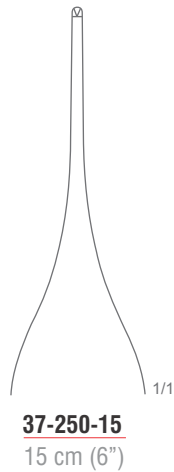
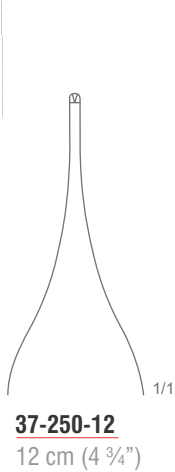
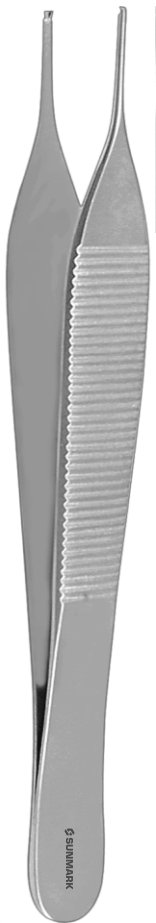

Adson Dissecting Forcep
1 x 2 Teeth

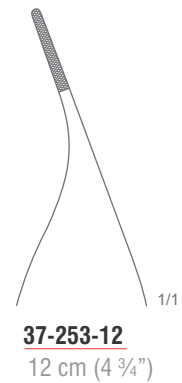
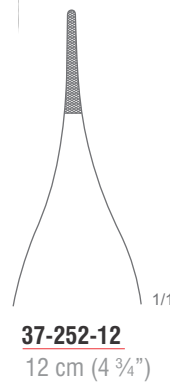
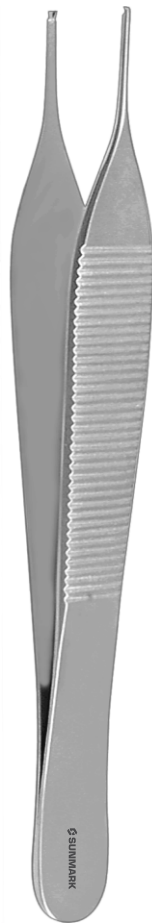

Mini-Adson Dissecting Forcep
1 x 2 Teeth, Cross Serrated
Overall Length 15 cm (6")



Dissecting Forceps
Anatomische Pinzetten
Pinzas de disección
Pincas à dissection
Pinze per dissezione

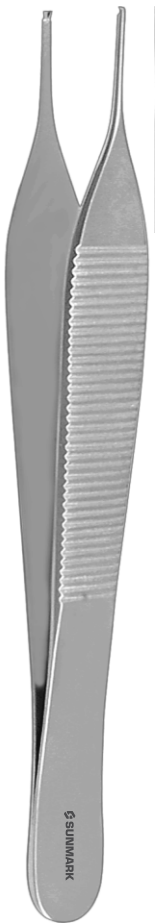

37-256-12
12 cm (4 3/4")

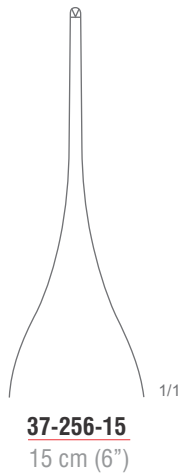

37-256-15
15 cm (6")

Micro-Adson Dissecting Forcep
1 x 2 Teeth

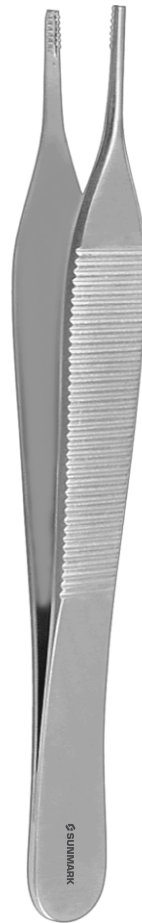

37-258-12
12 cm (5")

37-258-15
15 cm (6")

Adson-Brown Dissecting Forcep
7 x 7 Teeth



**Make a Linework
From KLS Martin**

Dissecting Forceps
Anatomische Pinzetten
Pinzas de disección
Pinces à dissection
Pinze per dissezione

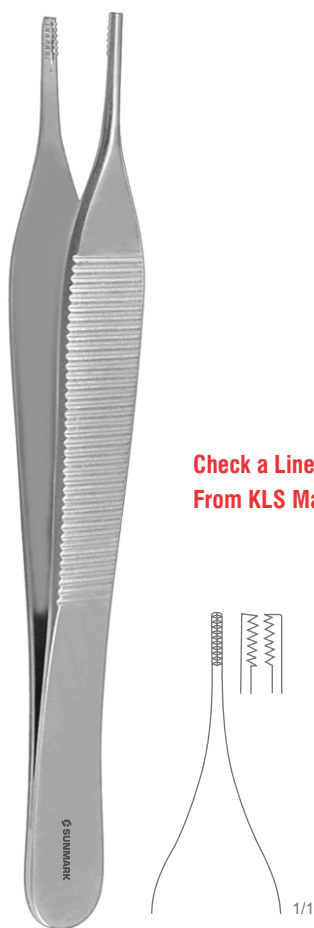

**Check a Linework
From KLS Martin**

37-260-12
Adson-Brown Dissecting Forcep
9 x 9 Teeth
Overall Length 12 cm (5")



Dissecting Forceps
 Anatomische Pinzetten
 Pinzas de disección
 Pinces à dissection
 Pinze per dissezione



37-270-15
Gillies Dissecting Forcep
 1 x 2 Teeth, Cross Serrated
 Overall Length 15.5 cm (6")



Waugh Dissecting Forcep
 1 x 2 Teeth, Cross Serrated

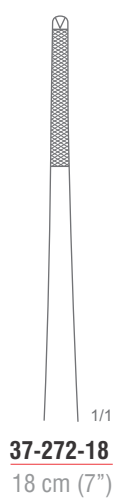

37-272-18
 18 cm (7")

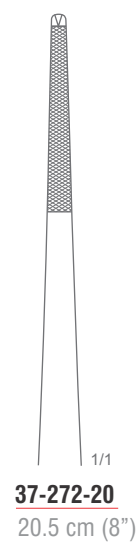

37-272-20
 20.5 cm (8")

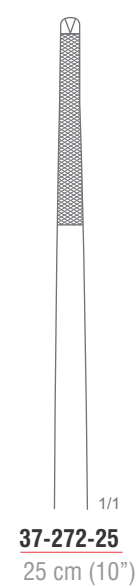

37-272-25
 25 cm (10")

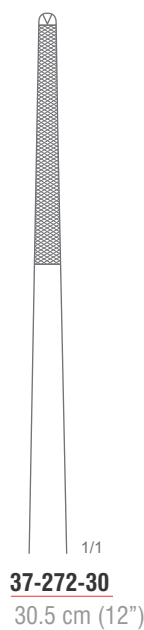

37-272-30
 30.5 cm (12")

Dissecting Forceps
Anatomische Pinzetten
Pinzas de disección
Pincès à dissection
Pinze per dissezione

THORAX, CARDIOVASCULAR SURGERY

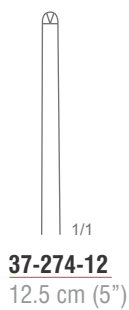

Semken Dissecting Forcep
1 x 2 Teeth



Taylor Dissecting Forcep
1 x 2 Teeth
Overall Length 17.5 cm (7")



Taylor Dissecting Forcep
1 x 2 Teeth, With Dissector End
Overall Length 17 cm (6 3/4")



Dissecting Forceps
Anatomische Pinzetten
Pinzas de disección
Pincès à dissection
Pinze per dissezione



37-283-17
Taylor Dissecting Forcep
1 x 2 Teeth, Bayonet Shaped
Overall Length 18.5 cm (7 1/4")



37-286-06 0.6 mm
37-286-08 0.8 mm
37-286-10 1.0 mm

Dissecting Forcep
1 x 2 Teeth
Overall Length 15.5 cm (6")



Dissecting Forceps
Anatomische Pinzetten
Pinzas de disección
Pincers à dissection
Pinze per dissezione



37-290-17
Straight
17.5 cm (7")

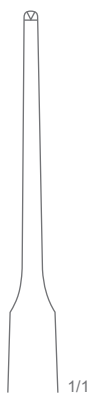

37-290-23
Straight
23 cm (9")

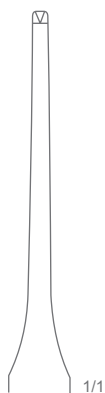

37-291-17
Curved
17.5 cm (7")

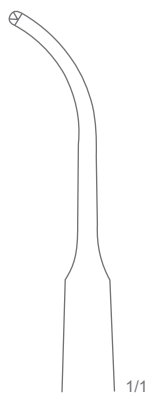

Gerald Dissecting Forcep
1 x 2 Teeth



37-294-18
18 cm (7")



37-294-21
21 cm (8 1/4")

37-294-25
24 cm (9 1/2")

Cushing Dissecting Forcep
1 x 2 Teeth



Dissecting Forceps
Anatomische Pinzetten
Pinzas de disección
Pincas à dissection
Pinze per dissezione



37-296-18
18 cm (7")

37-296-21
21 cm (8 1/4")

37-296-25
24 cm (9 1/2")

Potts-Smith Dissecting Forcep
1 x 2 Teeth

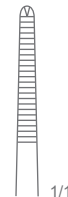

37-298-15
McIndoe Dissecting Forcep
1 x 2 Teeth
Overall Length 15 cm (6")



Dissecting Forceps
Anatomische Pinzetten
Pinzas de disección
Pinces à dissection
Pinze per dissezione

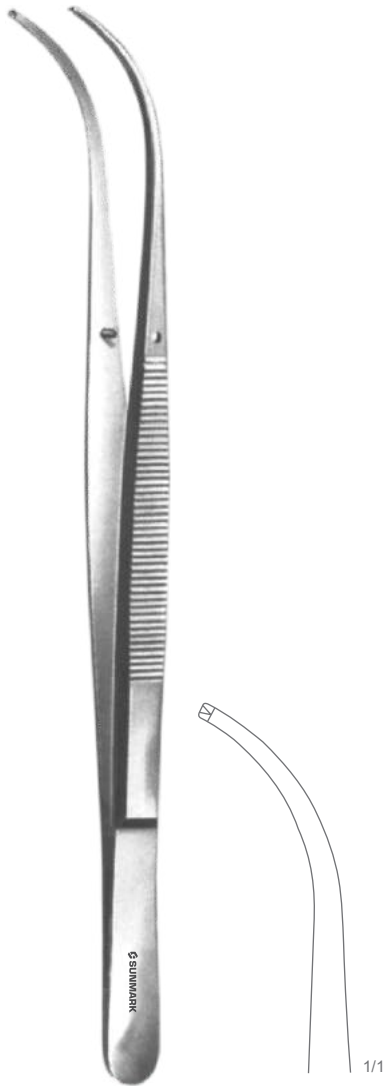

37-300-20
Brophy Dissecting Forcep
1 x 2 Teeth
Overall Length 20 cm (8")



THORAX, CARDIOVASCULAR SURGERY

Jeweller Type Forceps
 Uhrmacher-Pinzetten
 Pinzas de relojero
 Pinces d'horloger
 Pinze da orologiaio



37-310-01
Jeweller Forcep
 Fig. 1
 Overall Length 12 cm (5")



37-310-02
Jeweller Forcep
 Fig. 2
 Overall Length 12 cm (5")



37-310-03
Jeweller Forcep
 Fig. 3
 Overall Length 12 cm (4 3/4")



37-310-04
Jeweller Forcep
 Fig. 4
 Overall Length 11 cm (4 1/4")

Jeweller Type Forceps
Uhrmacher-Pinzetten
Pinzas de relojero
Pincès d'horloger
Pinze da orologiaio

THORAX, CARDIOVASCULAR SURGERY



37-310-05
Jeweller Forcep
Fig. 5
Overall Length 11 cm (4 1/4")



37-310-07
Jeweller Forcep
Fig. 7
Overall Length 12 cm (4 3/4")



37-310-13
Jeweller Forcep
Fig. 3C
Overall Length 11 cm (4 1/4")



37-310-15
Jeweller Forcep
Fig. 5A
Overall Length 11 cm (4 1/4")

Jeweller Type Forceps
 Uhrmacher-Pinzetten
 Pinzas de relojero
 Pinces d'horloger
 Pinze da orologiaio



37-310-45
Jeweller Forcep
 Fig. 5/45°
 Overall Length 10.5 cm (4 1/4")



37-310-90
Jeweller Forcep
 Fig. 5/90°
 Overall Length 10.5 cm (4 1/4")



37-313-13
Jeweller Forcep
 1 x 2 Teeth, 0.4 mm
 Overall Length 11.5 cm (4 1/2")



Jeweller Type Forceps
Uhrmacher-Pinzetten
Pinzas de relojero
Pincès d'horloger
Pinze da orologiaio



37-316-13
Jeweller Forcep
0.3 mm
Overall Length 13.5 cm (5 1/4")



37-318-13
Jeweller Forcep
1 x 2 Teeth, 0.4 mm
Overall Length 13.5 cm (5 1/4")



37-320-12
Jeweller Forcep
Straight, With Plateau, 0.3 mm
Overall Length 12 cm (3 3/4")

Jeweller Type Forceps, Micro Dilating Forceps
Uhrmacher-Pinzetten, Gefäß-Dilatationspinzetten
Pinzas de relojero, Micro pinza de dilatación
Pinces d'horloger, Micro pince à dilater
Pinze da orologiaio, Micro pinze per dilatazione



37-322-13
Straight

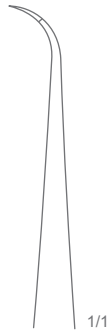

37-323-13
Curved

Vise Micro Jeweller Forcep
With Plateau, 0.3 mm
Overall Length 13.5 cm (5 1/4")



37-325-00
Ø 0.20 mm
Angled

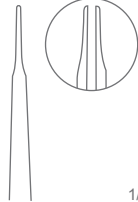

37-325-01
Ø 0.30 mm
Angled

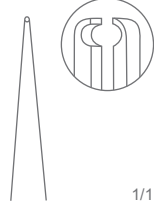

37-325-02
Ø 0.30 mm
Angled

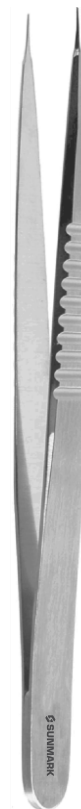

37-325-12
Ø 0.20 mm
Angled

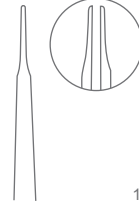

37-325-13
Ø 0.30 mm
Angled

Micro Vessel Dilator
Overall Length 11 cm (4 1/4")

Micro Vessel Dilator
Overall Length 13 cm (5")

Micro Dilating Forceps
Gefäß-Dilatationspinzetten
Micro pinza de dilatación
Micro pince à dilater
Micro pinze per dilatazione

THORAX, CARDIOVASCULAR SURGERY

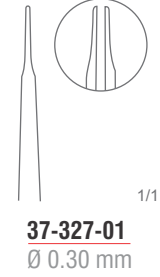
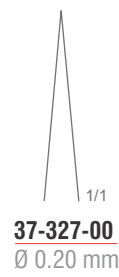
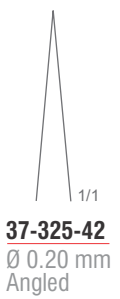

Micro Vessel Dilator
Overall Length 18 cm (7")

Micro Vessel Dilator
Overall Length 13 cm (5")

Micro Dilating Forceps, Tissue Forceps
 Gefäß-Dilatationspinzetten, Chirurgische Pinzetten
 Micro pinza de dilatación, Pinzas de disección con diente
 Micro pince à dilater, Pincés à dissection à griffes
 Micro pinze per dilatazione, Pinze per dissezione con denti



Discuss Omar Bhai

37-327-42
 Ø 0.20 mm
 Straight



37-327-43
 Ø 0.30 mm
 Straight

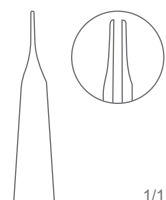

37-328-15
Selman Dissecting Forcep
 Overall Length 15.5 cm (6")



Tissue Forceps
 Chirurgische Pinzetten
 Pinzas de disección con diente
 Pincès à dissection à griffes
 Pinze per dissezione con denti

THORAX, CARDIOVASCULAR SURGERY

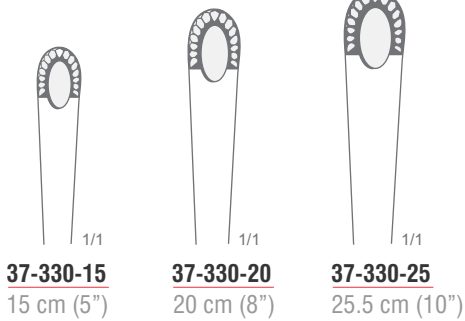

37-330-15
15 cm (5")

37-330-20
20 cm (8")

37-330-25
25.5 cm (10")

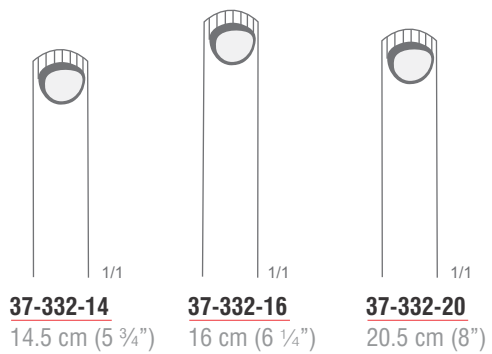

37-332-14
14.5 cm (5 3/4")

37-332-16
16 cm (6 1/4")

37-332-20
20.5 cm (8")

Russian Modell Dissecting Forcep

Durante Dissecting Forcep

Tissue Forceps
Chirurgische Pinzetten
Pinzas de disección con diente
Pincers à dissection à griffes
Pinze per dissezione con denti



37-334-18
18 cm (7")

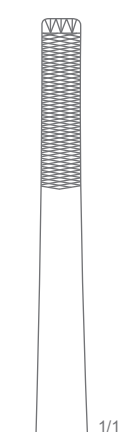

37-334-20
20 cm (8")

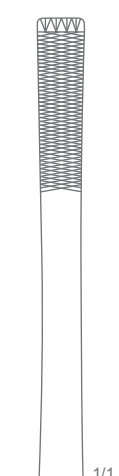

37-334-25
25 cm (9 3/4")



37-336-18
Ferris-Smith Dissecting Forcep
2 x 3 Teeth
Overall Length 18 cm (7")



Stille-Barraya Dissecting Forcep

Tissue Forceps
 Chirurgische Pinzetten
 Pinzas de disección con diente
 Pincers à dissection à griffes
 Pinze per dissezione con denti

THORAX, CARDIOVASCULAR SURGERY

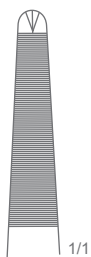

37-338-18
Bonney Dissecting Forcep
 1 x 2 Teeth
 Overall Length 17.5 cm (7")

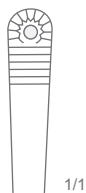

37-340-18
Mayo (Russian) Dissecting Forcep
 Overall Length 23 cm (9")

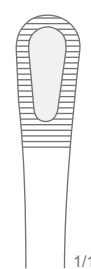

37-344-18
 18 cm (7")

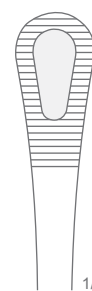

37-344-23
 23 cm (7")

Singley-Tuttle Dissecting Forcep



1:2



Tissue Forceps
Chirurgische Pinzetten
Pinzas de disección con diente
Pincès à dissection à griffes
Pinze per dissezione con denti



37-348-14
14.0 mm

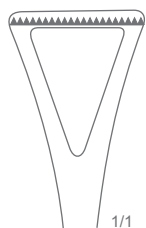

37-348-18
18.0 mm

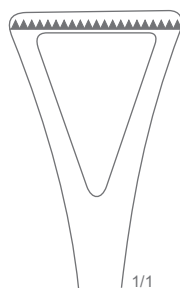

37-348-23
23.0 mm



37-350-14
Duval Intestinal Forcep
Overall Length 14 cm (5 1/2")

Collin-Duval Intestinal Forcep
Overall Length 20 cm (8")

Tissue Forceps
Chirurgische Pinzetten
Pinzas de disección con diente
Pincès à dissection à griffes
Pinze per dissezione con denti



37-352-19
Dennis-Browne Intestinal Forcep
Overall Length 19 cm (7 1/2")



37-354-15
16 cm (6")



37-354-23
23 cm (9")

Nelson Dissecting Forcep
7 x 8 Teeth



37-360-12
1 x 2 Teeth
12.5 cm (5")

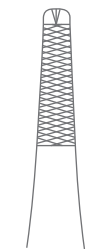

37-360-14
1 x 2 Teeth
14.5 cm (5 3/4")

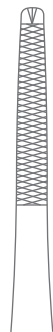

37-360-17
1 x 2 Teeth
17.5 cm (7")



37-362-14
2 x 3 Teeth
14.5 cm (5 3/4")



37-362-17
2 x 3 Teeth
17.5 cm (7")

Lane Dissecting Forcep



1:2



2:3

THORAX, CARDIOVASCULAR SURGERY

Tissue Forceps
Chirurgische Pinzetten
Pinzas de disección con diente
Pincers à dissection à griffes
Pinze per dissezione con denti

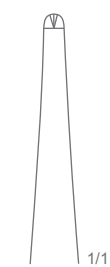

37-366-12
12.5 cm (5")



37-366-15
15 cm (6")

Treves Dissecting Forcep
1 x 2 Teeth

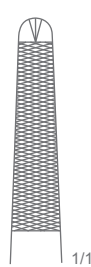

37-368-18
1 x 2 Teeth

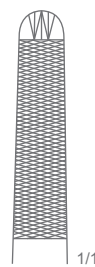

37-370-18
3 x 4 Teeth

Ramsey Dissecting Forcep
Overall Length 18 cm (7")



Tissue Forceps
Chirurgische Pinzetten
Pinzas de disección con diente
Pincès à dissection à griffes
Pinze per dissezione con denti

THORAX, CARDIOVASCULAR SURGERY

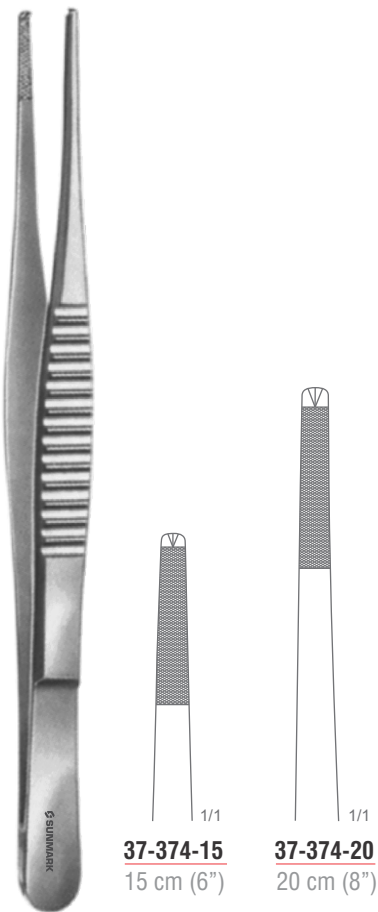

Strassburger Modell Dissecting Forcep
1 x 2 Teeth



37-376-14
Jackson-Burrows Dressing Forcep
1 x 2 Teeth, With Platform
Overall Length 14 cm (5 1/2")



37-378-18
Charnley Dressing Forcep
1 x 2 Teeth, With Platform
Overall Length 18 cm (7")



Grasping Forceps
 Fasspinzetten
 Pinzas para coger
 Pincas pour saisir les tissus
 Pinze per afferrare tessuti

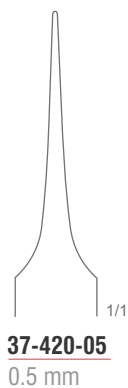

37-420-05
0.5 mm

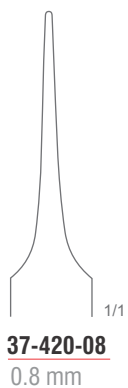

37-420-08
0.8 mm

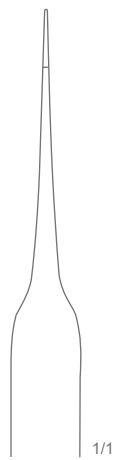

37-422-18
Micro Suturing Forcep
0.5 mm, With Platform
Overall Length 18.5 cm (7 1/4")

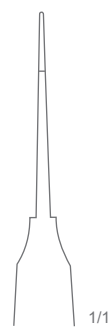
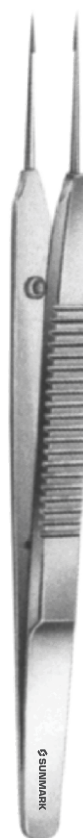

37-424-14
Austin Micro Suturing Forcep
0.8 mm, With Platform
Overall Length 14 cm (5 1/2")

Micro Forceps
Mikropinzetten
Micro Pinzas
Micro-Pinces
Micro-Pinze

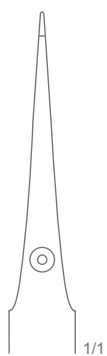

37-430-12
0.3 mm
Straight
12 cm (4 3/4")

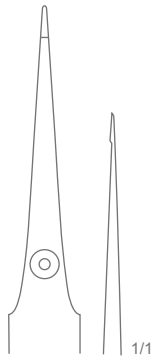

37-430-15
0.3 mm
Straight
15 cm (6")

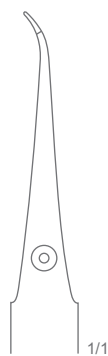

37-431-12
0.3 mm
Curved
12 cm (4 3/4")

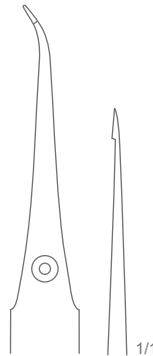

37-431-12
0.3 mm
Curved
15 cm (6")

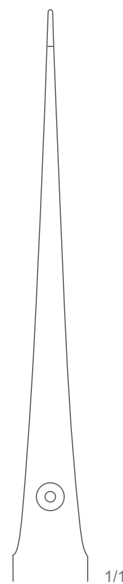

37-432-18
0.5 mm
Straight
18 cm (7")

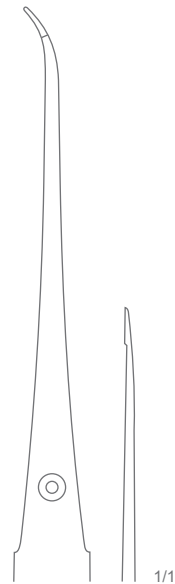



37-433-18
0.5 mm
Curved
18 cm (7")

Micro Suturing Forcep
With Platform

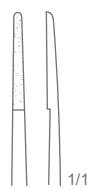
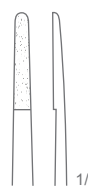

Micro Forceps
 Mikropinzetten
 Micro Pinzas
 Micro-Pinces
 Micro-Pinze



			
1/1	1/1	1/1	1/1
37-500-15 Straight 6.0 x 4.0 mm 15 cm (6")	37-500-18 Curved 6.0 x 4.0 mm 18 cm (7")	37-501-15 Curved 6.0 x 4.0 mm 15 cm (6")	37-501-18 Curved 6.0 x 4.0 mm 18 cm (7")

Diam-n-Dust™ Micro Dressing Forcep

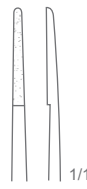
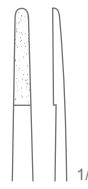

			
1/1	1/1	1/1	1/1
37-500-15 T Straight 6.0 x 4.0 mm 15 cm (6")	37-500-18 T Curved 6.0 x 4.0 mm 18 cm (7")	37-501-15 T Curved 6.0 x 4.0 mm 15 cm (6")	37-501-18 T Curved 6.0 x 4.0 mm 18 cm (7")

Diam-n-Dust™ Micro Dressing Forcep
 Titanium

Micro Forceps
 Mikropinzetten
 Micro Pinzas
 Micro-Pinces
 Micro-Pinze

THORAX, CARDIOVASCULAR SURGERY

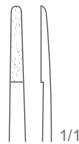
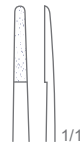
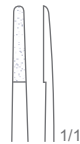
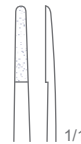
37-504-15
 Straight
 6.0 x 7.0 mm
 15 cm (6")

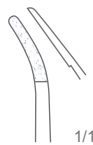
37-504-18
 Straight
 6.0 x 7.0 mm
 18 cm (7")

37-504-21
 Straight
 6.0 x 7.0 mm
 21 cm (8 1/4")

37-504-23
 Straight
 6.0 x 7.0 mm
 23 cm (9")

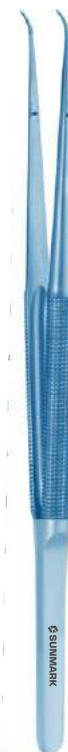
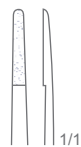
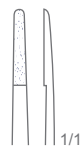
37-505-15
 Curved
 6.0 x 7.0 mm
 15 cm (6")

37-505-18
 Curved
 6.0 x 7.0 mm
 18 cm (7")

37-505-21
 Curved
 6.0 x 7.0 mm
 21 cm (8 1/4")

37-505-23
 Curved
 6.0 x 7.0 mm
 23 cm (9")

Diam-n-Dust™ Micro Dressing Forcep

37-504-15 T
 Straight
 6.0 x 7.0 mm
 15 cm (6")

37-504-18 T
 Straight
 6.0 x 7.0 mm
 18 cm (7")

37-504-21 T
 Straight
 6.0 x 7.0 mm
 21 cm (8 1/4")

37-505-15 T
 Curved
 6.0 x 7.0 mm
 15 cm (6")

37-505-18 T
 Curved
 6.0 x 7.0 mm
 18 cm (7")

37-505-21 T
 Curved
 6.0 x 7.0 mm
 21 cm (8 1/4")

Diam-n-Dust™ Micro Dressing Forcep
 Titanium

Micro Forceps
 Mikropinzetten
 Micro Pinzas
 Micro-Pinces
 Micro-Pinze

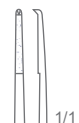

37-508-15
 Straight
 1 x 2 Teeth
 6.0 x 4.0 mm
 15 cm (6")

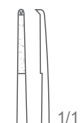

37-508-18
 Straight
 1 x 2 Teeth
 6.0 x 4.0 mm
 18 cm (7")



37-509-15
 Curved
 1 x 2 Teeth
 6.0 x 4.0 mm
 15 cm (6")



37-509-18
 Curved
 1 x 2 Teeth
 6.0 x 4.0 mm
 18 cm (7")

Diam-n-Dust™ Micro Dressing Forcep

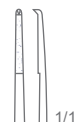
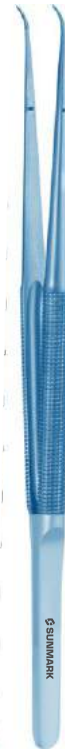

37-508-15 T
 Straight
 1 x 2 Teeth
 6.0 x 4.0 mm
 15 cm (6")

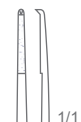

37-508-18 T
 Straight
 1 x 2 Teeth
 6.0 x 4.0 mm
 18 cm (7")



37-509-15 T
 Curved
 1 x 2 Teeth
 6.0 x 4.0 mm
 15 cm (6")



37-509-18 T
 Curved
 1 x 2 Teeth
 6.0 x 4.0 mm
 18 cm (7")

Diam-n-Dust™ Micro Dressing Forcep
 Titanium

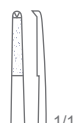
Micro Forceps
 Mikropinzetten
 Micro Pinzas
 Micro-Pinces
 Micro-Pinze

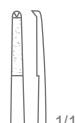
37-512-15

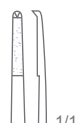
 Straight
 1 x 2 Teeth
 6.0 x 7.0 mm
 15 cm (6")

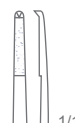
37-512-18

 Straight
 1 x 2 Teeth
 6.0 x 7.0 mm
 18 cm (7")

37-512-21

 Straight
 1 x 2 Teeth
 6.0 x 74.0 mm
 21 cm (8 1/4")

37-512-23

 Straight
 1 x 2 Teeth
 6.0 x 7.0 mm
 23 cm (9")

37-513-15

 Curved
 1 x 2 Teeth
 6.0 x 7.0 mm
 15 cm (6")

37-513-18

 Curved
 1 x 2 Teeth
 6.0 x 7.0 mm
 18 cm (7")

37-513-21

 Curved
 1 x 2 Teeth
 6.0 x 74.0 mm
 21 cm (8 1/4")

37-513-23

 Curved
 1 x 2 Teeth
 6.0 x 7.0 mm
 23 cm (9")

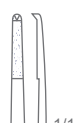
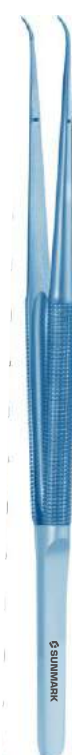
Diam-n-Dust™ Micro Dressing Forceps

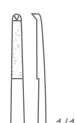
37-512-15 T

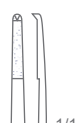
 Straight
 1 x 2 Teeth
 6.0 x 7.0 mm
 15 cm (6")

37-512-18 T

 Straight
 1 x 2 Teeth
 6.0 x 7.0 mm
 18 cm (7")

37-512-21 T

 Straight
 1 x 2 Teeth
 6.0 x 74.0 mm
 21 cm (8 1/4")

37-513-15 T

 Straight
 1 x 2 Teeth
 6.0 x 7.0 mm
 15 cm (6")

37-513-18 T

 Straight
 1 x 2 Teeth
 6.0 x 7.0 mm
 18 cm (7")

37-513-21 T

 Curved
 1 x 2 Teeth
 6.0 x 7.0 mm
 21 cm (8 1/4")

Diam-n-Dust™ Micro Dressing Forceps
 Titanium

Micro Forceps
 Mikropinzetten
 Micro Pinzas
 Micro-Pinces
 Micro-Pinze



37-516-15
 Ø 1.0 x 0.5 mm
 15 cm (6")



37-516-18
 Ø 1.0 x 0.5 mm
 18 cm (7")



37-516-21
 Ø 1.0 x 0.5 mm
 21 cm (8 1/4")



37-516-23
 Ø 1.0 x 0.5 mm
 23 cm (9")



37-518-15
 Ø 2.0 x 1.0 mm
 15 cm (6")



37-518-18
 Ø 2.0 x 1.0 mm
 18 cm (7")



37-518-21
 Ø 2.0 x 1.0 mm
 21 cm (8 1/4")



37-518-23
 Ø 2.0 x 1.0 mm
 23 cm (9")

Diam-n-Dust™ Micro Dressing Forcep

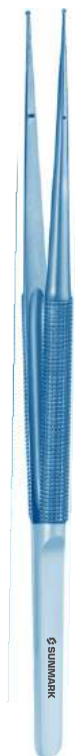

37-516-15 T
 Ø 1.0 x 0.5 mm
 15 cm (6")



37-516-18 T
 Ø 1.0 x 0.5 mm
 18 cm (7")



37-516-21 T
 Ø 1.0 x 0.5 mm
 21 cm (8 1/4")



37-518-15 T
 Ø 2.0 x 1.0 mm
 15 cm (6")



37-518-18 T
 Ø 2.0 x 1.0 mm
 18 cm (7")



37-518-21 T
 Ø 2.0 x 1.0 mm
 21 cm (8 1/4")

**Diam-n-Dust™ Micro Dressing Forcep
 Titanium**

Micro Forceps
 Mikropinzetten
 Micro Pinzas
 Micro-Pinces
 Micro-Pinze

THORAX, CARDIOVASCULAR SURGERY

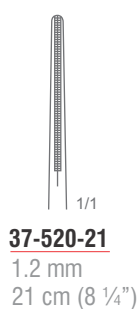
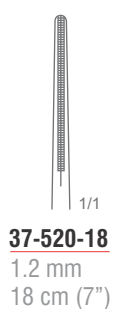
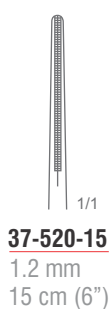

Micro Atrauma Forcep

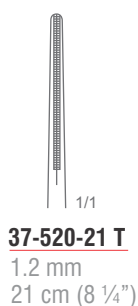
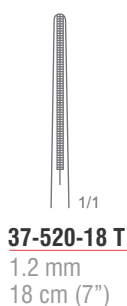
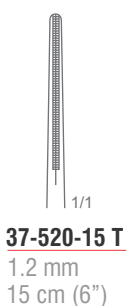
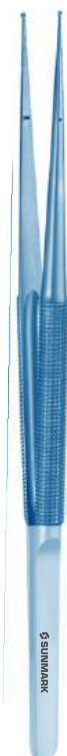

**Micro Atrauma Forcep
 Titanium**

Micro Forceps
 Mikropinzetten
 Micro Pinzas
 Micro-Pinces
 Micro-Pinze



37-522-00
 Straight
 Ø 0.4 mm

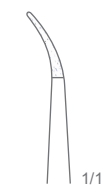

37-522-01
 Curved
 Ø 0.4 mm

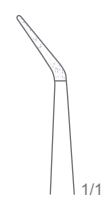

37-522-02
 Angled
 Ø 0.4 mm



FR-522-03
 Ø 1.0 x 0.5 mm

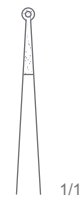

Diam-n-Dust™ Micro Suturing Forcep
 Overall Length 15 cm (6")

Diam-n-Dust™ Micro Ring Forcep
 Overall Length 15 cm (6")



FR-524-04
 Ø 0.3 mm

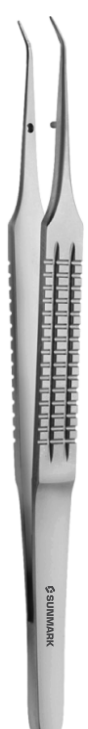
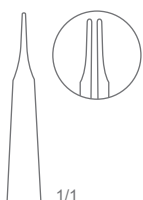

FR-524-05
 Ø 0.4 mm

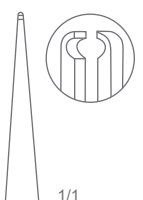

Micro Vessel Dilator
 Overall Length 15 cm (6")

Micro Pierce Dilator
 Overall Length 15 cm (6")

Micro Forceps
Mikropinzetten
Micro Pinzas
Micro-Pinces
Micro-Pinze

THORAX, CARDIOVASCULAR SURGERY

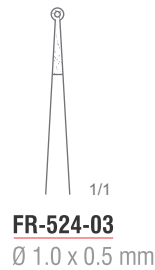

Diam-n-Dust™ Micro Suturing Forcep
Overall Length 18 cm (7")

Diam-n-Dust™ Micro Ring Forcep
Overall Length 18 cm (7")

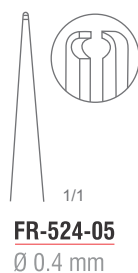
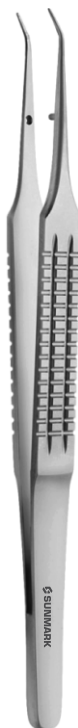
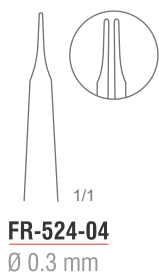
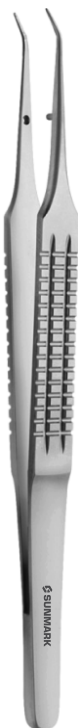

Micro Vessel Dilator
Overall Length 18 cm (7")

Micro Pierce Dilator
Overall Length 18 cm (7")

Micro Forceps
Mikropinzetten
Micro Pinzas
Micro-Pinces
Micro-Pinze

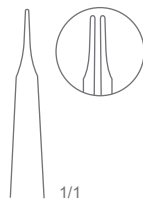

37-526-00
Micro Vessel Dilator
Ø 0.3 mm
With Counter Balance
Overall Length 15 cm (6")

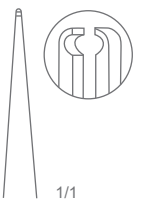

37-526-01
Micro Pierce Dilator
Ø 0.3 mm
With Counter Balance
Overall Length 15 cm (6")

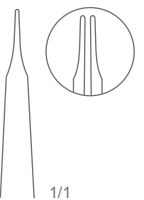

37-528-00
Micro Vessel Dilator
Ø 0.3 mm
With Counter Balance
Overall Length 18 cm (7")

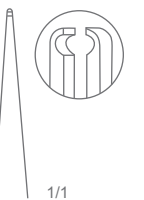

37-528-01
Micro Pierce Dilator
Ø 0.3 mm
With Counter Balance
Overall Length 18 cm (7")

Micro Forceps
 Mikropinzetten
 Micro Pinzas
 Micro-Pinces
 Micro-Pinze

THORAX, CARDIOVASCULAR SURGERY

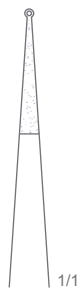

37-530-15
 Ø 1.0 mm
 15 cm (6")

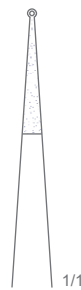

37-530-18
 Ø 1.0 mm
 18.5 cm (7 1/4")

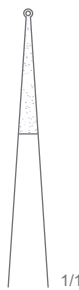

37-530-21
 Ø 1.0 mm
 21 cm (8 1/4")

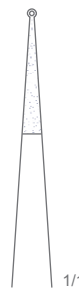

37-530-23
 Ø 1.0 mm
 23 cm (9")

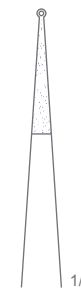

37-530-25
 Ø 1.0 mm
 25 cm (9 3/4")

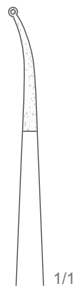

37-531-15
 Ø 1.0 mm
 15 cm (6")

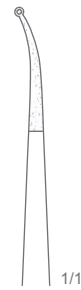

37-531-18
 Ø 1.0 mm
 18.5 cm (7 1/4")

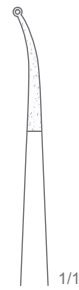

37-531-21
 Ø 1.0 mm
 21 cm (8 1/4")

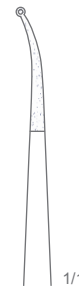

37-531-23
 Ø 1.0 mm
 23 cm (9")

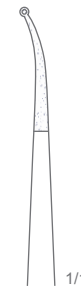

37-531-25
 Ø 1.0 mm
 25 cm (9 3/4")

Diam-n-Dust™ Micro Ring Forcep
 Straight, With Counter Balance

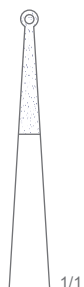
Micro Forceps
 Mikropinzetten
 Micro Pinzas
 Micro-Pinces
 Micro-Pinze

37-534-18
Diam-n-Dust™ Micro Ring Forcep
 Straight, Ø 0.2 mm
 With Counter Balance
 Overall Length 18.5 cm (7 ¼")

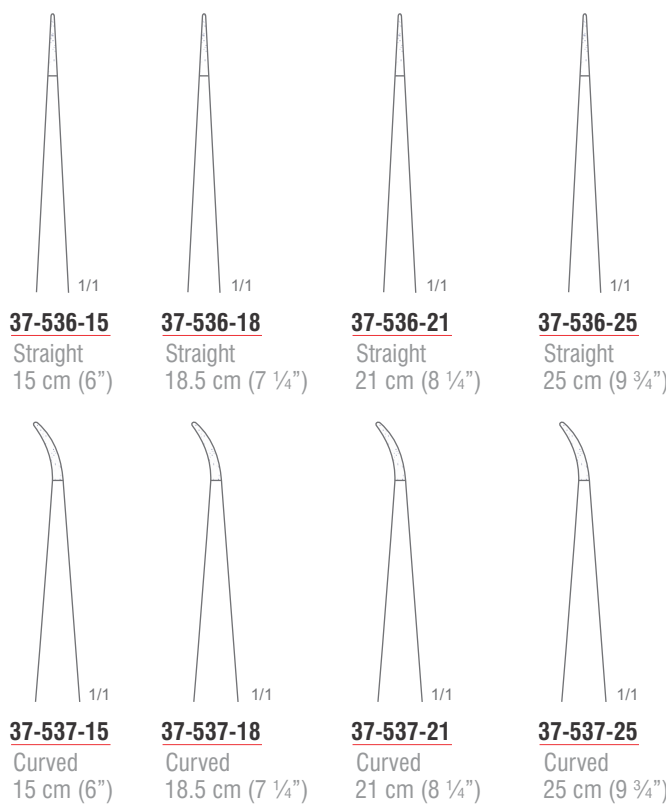

Diam-n-Dust™ Micro Suturing Forcep
 With Counter Balance

37-536-15
 Straight
 15 cm (6")

37-536-18
 Straight
 18.5 cm (7 ¼")

37-536-21
 Straight
 21 cm (8 ¼")

37-536-25
 Straight
 25 cm (9 ¾")

37-537-15
 Curved
 15 cm (6")

37-537-18
 Curved
 18.5 cm (7 ¼")

37-537-21
 Curved
 21 cm (8 ¼")

37-537-25
 Curved
 25 cm (9 ¾")

Micro Forceps
Mikropinzetten
Micro Pinzas
Micro-Pinces
Micro-Pinze

THORAX, CARDIOVASCULAR SURGERY



37-540-18
1.2 mm
18.5 cm (7 1/4")



37-540-21
1.2 mm
21 cm (8 1/4")



37-540-18 T
1.2 mm
18.5 cm (7 1/4")

Micro Atrauma Forcep
With Counter Balance

Micro Atrauma Forcep
With Counter Balance
Titanium

Micro Forceps
Mikropinzetten
Micro Pinzas
Micro-Pinces
Micro-Pinze



Gerald Micro Forcep
Cross Serrated Jaws

37-558-18
1.0 mm
18 cm (7")

37-558-25
1.0 mm
25 cm (9 3/4")



Gerald (DeBakey) Micro Atrauma Forcep
Cross Serrated Jaws

37-560-18
1.0 mm
18 cm (7")

37-560-21
1.0 mm
20 cm (8")

Micro Forceps
Mikropinzetten
Micro Pinzas
Micro-Pinces
Micro-Pinze

37

THORAX, CARDIOVASCULAR SURGERY

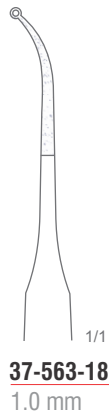

Diam-n-Dust™ Gerald Micro Ring Forcep
Overall Length 18 cm (7")



37-566-18
1.0 mm
18 cm (7")

37-566-20
1.0 mm
20 cm (8")

Diam-n-Dust™ Gerald Micro Ring Forcep



37-566-18 T
1.0 mm

Diam-n-Dust™ Gerald Micro Ring Forcep
Titanium
Overall Length 18 cm (7")

Micro Forceps
Mikropinzetten
Micro Pinzas
Micro-Pinces
Micro-Pinze

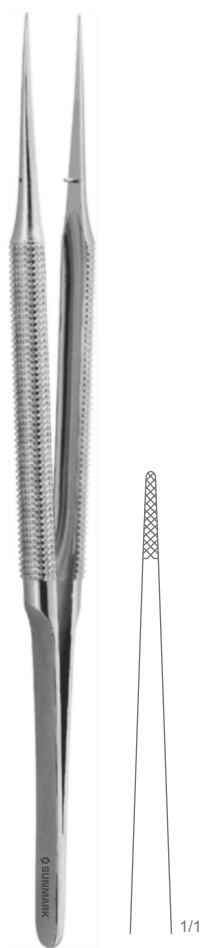

37-568-20
Micro Dressing Forcep
Cross Serrated Jaws
Overall Length 20 cm (8")



Resano Forcep Multi-Toothed



37-570-18
18 cm (7")

37-570-23
23 cm (9")

37-570-32
32 cm (12 1/2")

Micro Forceps
Mikropinzetten
Micro Pinzas
Micro-Pinces
Micro-Pinze

THORAX, CARDIOVASCULAR SURGERY



37-580-15
1.2 mm
15 cm (6")

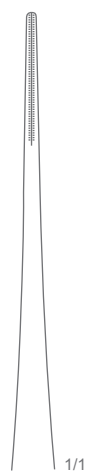

37-582-20
1.5 mm
20 cm (8")



37-582-24
1.5 mm
24 cm (9 1/2")

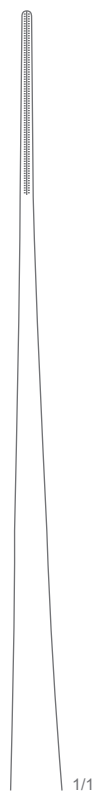

37-582-30
1.5 mm
30 cm (11 3/4")

DeBakey Atrauma Forcep
Ultra Light Pattern



Micro Forceps
 Mikropinzetten
 Micro Pinzas
 Micro-Pinces
 Micro-Pinze



37-584-15
 1.0 mm
 15 cm (6")



37-584-20
 1.0 mm
 20 cm (8")

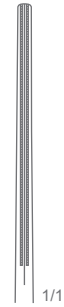

37-584-24
 1.0 mm
 24 cm (9 1/2")

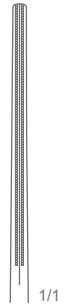

DeBakey Atrauma Forcep



37-590-16
 1.5 mm
 16 cm (6 1/4")



37-590-20
 1.5 mm
 20 cm (8")



37-590-24
 1.5 mm
 24.5 cm (9 3/4")



37-590-30
 1.5 mm
 30 cm (11 3/4")

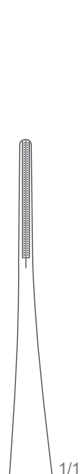

DeBakey Atrauma Forcep

Micro Forceps
 Mikropinzetten
 Micro Pinzas
 Micro-Pinces
 Micro-Pinze

37-590-16 T
 1.5 mm
 16 cm (6 1/4")

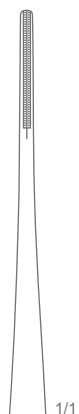

37-590-20 T
 1.5 mm
 20 cm (8")

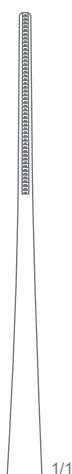

37-590-24 T
 1.5 mm
 24.5 cm (9 3/4")

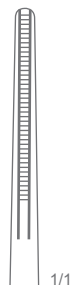
DeBakey Atrauma Forcep
 Titanium

37-592-16
 2.0 mm
 16 cm (6 1/4")

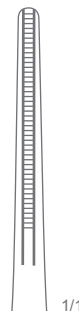

37-592-20
 2.0 mm
 20 cm (8")

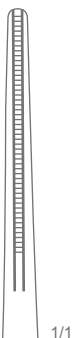

37-592-24
 2.0 mm
 24.5 cm (9 3/4")

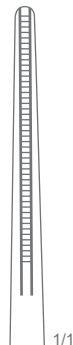

37-592-30
 2.0 mm
 30 cm (11 3/4")

DeBakey Atrauma Forcep

Micro Forceps
 Mikropinzetten
 Micro Pinzas
 Micro-Pinces
 Micro-Pinze

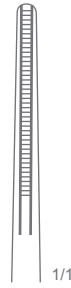

37-592-16 T
 2.0 mm
 16 cm (6 1/4")

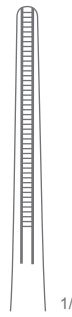

37-592-20 T
 2.0 mm
 20 cm (8")

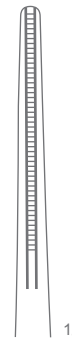

37-592-24 T
 2.0 mm
 24.5 cm (9 3/4")

DeBakey Atrauma Forcep
 Titanium

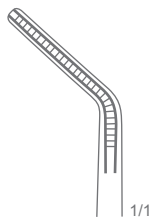

37-593-16
 2.0 mm
 16 cm (6 1/4")

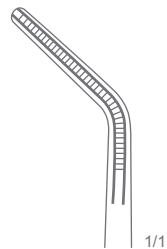

37-593-20
 2.0 mm
 19.5 cm (7 3/4")

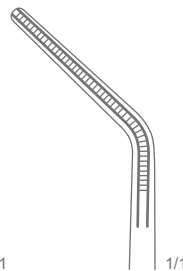

37-593-24
 2.0 mm
 24.5 cm (9 3/4")

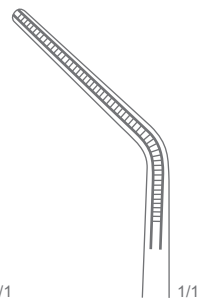

37-593-30
 2.0 mm
 29.5 cm (11 1/2")

DeBakey Atrauma Forcep
 Angled

Micro Forceps
Mikropinzetten
Micro Pinzas
Micro-Pinces
Micro-Pinze

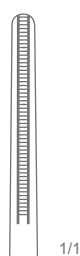

37-594-16
2.8 mm
16 cm (6 1/4")

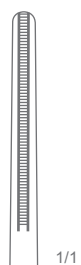

37-594-20
2.8 mm
20 cm (8")

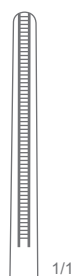

37-594-24
2.8 mm
24.5 cm (9 3/4")

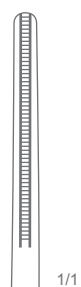

37-594-30
2.8 mm
30 cm (11 3/4")

DeBakey Atrauma Forcep

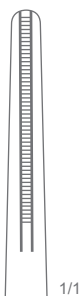

37-596-16
3.5 mm
16 cm (6 1/4")

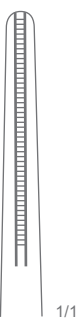

37-596-20
3.5 mm
20 cm (8")

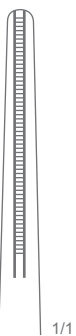

37-596-24
3.5 mm
24.5 cm (9 3/4")

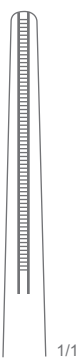

37-596-30
3.5 mm
30 cm (11 3/4")

DeBakey Atrauma Forcep

Micro Forceps
 Mikropinzetten
 Micro Pinzas
 Micro-Pinces
 Micro-Pinze



Cooley Atrauma Forcep

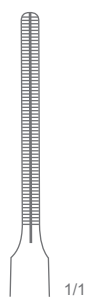

37-598-16
 2.0 mm
 16 cm (6 1/4")

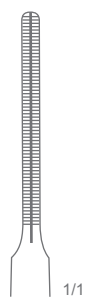

37-598-20
 2.0 mm
 20 cm (8")

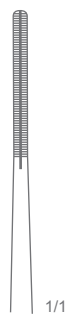

37-598-24
 2.0 mm
 24 cm (9 1/2")

Tissue Forceps, Dissecting Forceps
 Chirurgische Pinzetten, Anatomische Pinzetten
 Pinzas de disección con diente, Pinzas de disección
 Pincés à dissection à griffes, Pincés à dissection
 Pinze per dissezione con denti, Pinze per dissezione



37-940-17
UltraGrip™ TC Bonney Dissecting Forcep
 1 x 2 Teeth
 Overall Length 17.5 cm (7")



37-942-17
UltraGrip™ TC Gerald Dissecting Forcep
 1 x 2 Teeth
 Overall Length 17.5 cm (7")



37-944-15
UltraGrip™ TC Gillies Dissecting Forcep
 1 x 2 Teeth
 Overall Length 15.5 cm (6")



Tissue Forceps, Dissecting Forceps
 Chirurgische Pinzetten, Anatomische Pinzetten
 Pinzas de disección con diente, Pinzas de disección
 Pincès à dissection à griffes, Pincès à dissection
 Pinze per dissezione con denti, Pinze per dissezione



37-946-15
UltraGrip™ TC Gillies Dissecting Forcep
 Overall Length 15 cm (6")



37-950-16 16 cm (6 1/4")
37-950-18 18 cm (7")

UltraGrip™ TC Semken Dissecting Forcep
 1 x 2 Teeth



37-952-16 16 cm (6 1/4")
37-952-18 18 cm (7")

UltraGrip™ TC Micro-Semken Dissecting Forcep
 1 x 2 Teeth



37-956-12
UltraGrip™ TC Adson-Brown Dissecting Forcep
 Overall Length 12 cm (4 3/4")

Tissue Forceps, Dissecting Forceps
 Chirurgische Pinzetten, Anatomische Pinzetten
 Pinzas de disección con diente, Pinzas de disección
 Pincès à dissection à griffes, Pincès à dissection
 Pinze per dissezione con denti, Pinze per dissezione

THORAX, CARDIOVASCULAR SURGERY

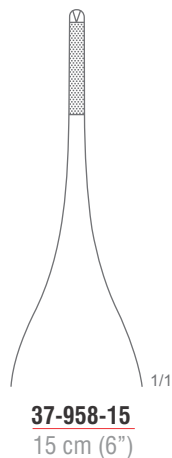
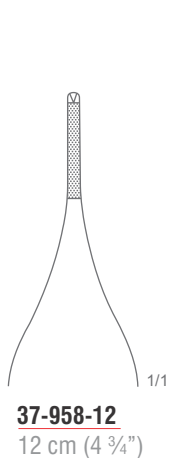

UltraGrip™ TC Micro-Adson Dissecting Forcep
1 x 2 Teeth



1:2

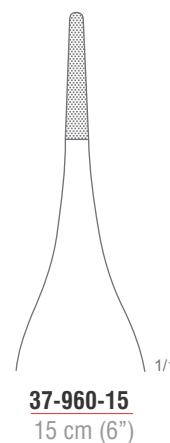
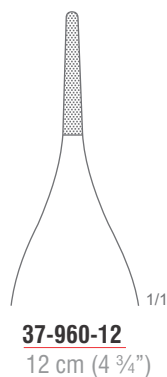

UltraGrip™ TC Adson Dressing Forcep



Tissue Forceps, Dissecting Forceps
 Chirurgische Pinzetten, Anatomische Pinzetten
 Pinzas de disección con diente, Pinzas de disección
 Pincès à dissection à griffes, Pincès à dissection
 Pinze per dissezione con denti, Pinze per dissezione

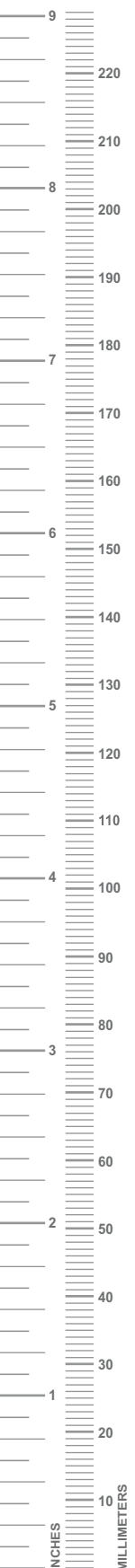

37-962-12
 12 cm (4 3/4")

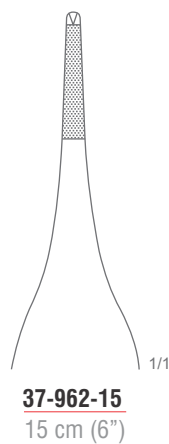

37-962-15
 15 cm (6")



37-966-17
 17.5 cm (7")

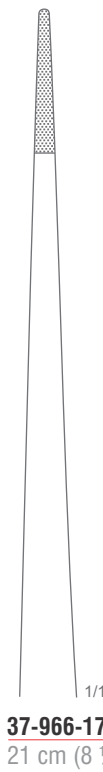

37-966-17
 21 cm (8 1/4")

UltraGrip™ TC Adson Dissecting Forcep
 1 x 2 Teeth

UltraGrip™ TC Cushing Dressing Forcep
 Straight



1:2

Tissue Forceps, Dissecting Forceps
 Chirurgische Pinzetten, Anatomische Pinzetten
 Pinzas de disección con diente, Pinzas de disección
 Pincès à dissection à griffes, Pincès à dissection
 Pinze per dissezione con denti, Pinze per dissezione



37-967-17
UltraGrip™ TC Cushing Dressing Forcep
 Angled
 Overall Length 17 cm (6 3/4")

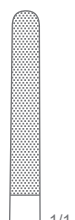

37-967-17
UltraGrip™ TC Cushing-Taylor Dressing Forcep
 Bayonet Shaped
 Overall Length 18.5 cm (7 1/4")

37-972-15
 16 cm (6 1/4")



37-972-18
 18.5 cm (7 1/4")



37-972-23
 20 cm (8")

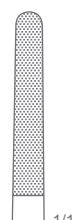

37-972-23
 23 cm (9")



37-972-25
 25 cm (9 3/4")

UltraGrip™ TC Potts-Smith Dressing Forcep

Tissue Forceps, Dissecting Forceps
 Chirurgische Pinzetten, Anatomische Pinzetten
 Pinzas de disección con diente, Pinzas de disección
 Pincès à dissection à griffes, Pincès à dissection
 Pinze per dissezione con denti, Pinze per dissezione



37-974-14
 14.5 cm (5 3/4")



1/1

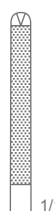

1/1

37-974-16
 16 cm (6 1/4")

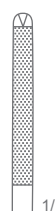

1/1

37-974-18
 18 cm (7")



1/1

37-974-20
 20 cm (8")



1/1

37-974-25
 25 cm (9 3/4")

UltraGrip™ TC Oehler Dissecting Forcep  1:2
 1 x 2 Teeth



37-978-17
UltraGrip™ TC Ferris-Smith Dissecting Forcep
 2 x 3 Teeth
 Overall Length 17.5 cm (7")



 2:3



37-980-15
 15 cm (6")

UltraGrip™ TC Wangensteen Dressing Forcep



37-980-23
 23 cm (9")

Tissue Forceps, Dissecting Forceps
 Chirurgische Pinzetten, Anatomische Pinzetten
 Pinzas de disección con diente, Pinzas de disección
 Pincès à dissection à griffes, Pincès à dissection
 Pinze per dissezione con denti, Pinze per dissezione

THORAX, CARDIOVASCULAR SURGERY

Codes Required On

37-974-14
 1.6 mm
 16 cm (6 1/4")

37-974-16
 1.6 mm
 20 cm (8")



37-974-14
 2.0 mm
 16 cm (6 1/4")

37-974-18
 1.6 mm
 24.5 cm (9 3/4")

37-974-18
 2.0 mm
 24.5 cm (9 3/4")

UltraGrip™ TC DeBakey Atraumatic Forceps

Operating Scissors
 Chirurgische Scheren
 Tijeras quirúrgicas
 Ciseaux chirurgicaux
 Forbici per chirurgia



23-010-14
Biemer Clip Applying Forcep
 Without Lock
 Overall Length 14.5 cm (5 3/4")



23-012-14
Biemer Clip Applying Forcep
 With Lock
 Overall Length 14.5 cm (5 3/4")



Biemer Vessel Clip



23-016-14
 14 mm
 Opening : 4 mm
 Jaw Length : 4 mm
 Closing Pressure : 30 - 40 gr



23-018-17
 17 mm
 Opening : 7 mm
 Jaw Length : 5 mm
 Closing Pressure : 30 - 40 gr



23-020-17
 17 mm
 Opening : 7 mm
 Jaw Length : 5 mm
 Closing Pressure : 20 - 25 gr

Operating Scissors
Chirurgische Scheren
Tijeras quirúrgicas
Ciseaux chirurgicaux
Forbici per chirurgia

THORAX, CARDIOVASCULAR SURGERY

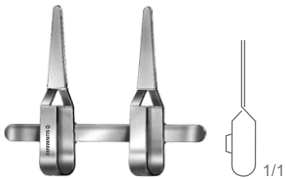

23-024-17
Biemer-Mueller Approximator
17 mm, Straight, Wide
Opening : 5 mm
Jaw Length : 9 mm
Closing Pressure : 25 - 30 gr

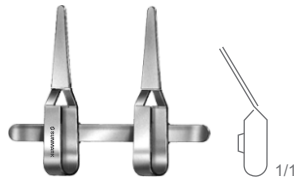

23-025-17
Biemer-Mueller Approximator
17 mm, Angled, Wide
Opening : 5 mm
Jaw Length : 9 mm
Closing Pressure : 25 - 30 gr

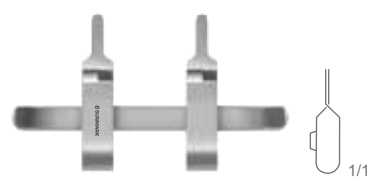

23-026-13
Biemer-Mueller Approximator
13 mm, Straight, Narrow
Opening : 3 mm
Jaw Length : 4.5 mm
Closing Pressure : 25 - 30 gr

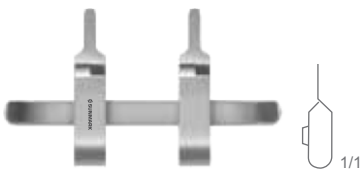

23-026-17
Biemer-Mueller Approximator
17 mm, Straight, Narrow
Opening : 5 mm
Jaw Length : 9 mm
Closing Pressure : 25 - 30 gr



23-026-17
Biemer-Mueller Approximator
17 mm, Straight, Narrow
Opening : 5 mm
Jaw Length : 9 mm
Closing Pressure : 25 - 30 gr



23-027-17
Biemer-Mueller Approximator
17 mm, Straight, Narrow
Opening : 5 mm
Jaw Length : 9 mm
Closing Pressure : 25 - 30 gr



Mueller Approximator
Overall Length 17 mm

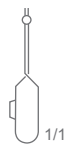

23-030-01
Ø 1.0 mm
Closing Pressure
25 - 30 gr

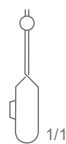

23-030-02
Ø 2.0 mm
Closing Pressure
25 - 30 gr

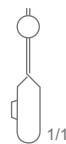

23-030-03
Ø 3.0 mm
Closing Pressure
25 - 30 gr

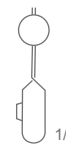

23-030-04
Ø 4.0 mm
Closing Pressure
25 - 30 gr

Operating Scissors
Chirurgische Scheren
Tijeras quirúrgicas
Ciseaux chirurgicaux
Forbici per chirurgia

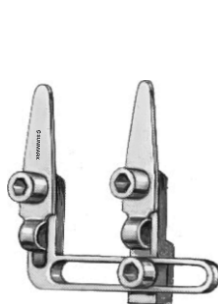

23-040-00
Nerve Approximator
Complete with Key
Standard



23-040-01
Key For Approximator



23-040-02
Nerve Approximator
Approximator Only
Standard

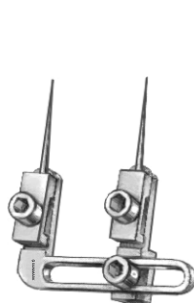

23-044-00
Nerve Approximator
Complete with Key
Needles Exchangeable by
Mean of Key
Standard



23-044-02
Nerve Approximator
Approximator With Needles Only
Standard

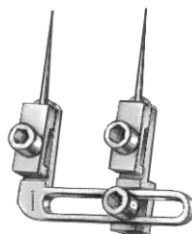

23-044-04
Spare Needle

Operating Scissors
Chirurgische Scheren
Tijeras quirúrgicas
Ciseaux chirurgicaux
Forbici per chirurgia



23-046-14
Clip Applying Forcep
With Ratchet
Overall Length 14.5 cm (5 3/4")



23-049-18
Clip Applying Forcep
Bayonet Shaped, With Ratchet
Overall Length 18.5 cm (7 1/4")

THORAX, CARDIOVASCULAR SURGERY



23-050-04
13 mm
Jaw Size : 4.0 x 0.75 mm
Closing Pressure : 60 gr

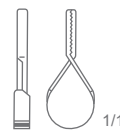

23-050-06
15 mm
Jaw Size : 6.0 x 1.0 mm
Closing Pressure : 85 gr



Mini Vessel Clip

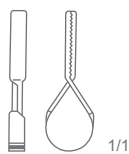

23-050-08
17 mm
Jaw Size : 8.0 x 2.0 mm
Closing Pressure : 100 gr

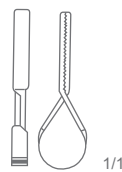

23-050-10
20 mm
Jaw Size : 10.0 x 2.0 mm
Closing Pressure : 125 gr

Operating Scissors
 Chirurgische Scheren
 Tijeras quirúrgicas
 Ciseaux chirurgicaux
 Forbici per chirurgia



Acland Micro Vessel Clamp
 For Vessels
 Single

<u>23-052-08</u> 8 mm Ø 0.4 - 1.0 mm	<u>23-052-11</u> 11 mm Ø 0.6 - 1.5 mm	<u>23-052-14</u> 14 mm Ø 0.1 - 2.25 mm	<u>23-052-17</u> 17 mm Ø 1.5 - 3.5 mm	<u>23-052-25</u> 25 mm Ø 2.0 - 5.0 mm
---	--	---	--	--



Acland Micro Vessel Clamp
 For Vessels
 Double

<u>23-054-08</u> 8 mm Ø 0.4 - 1.0 mm	<u>23-054-11</u> 11 mm Ø 0.6 - 1.5 mm	<u>23-054-14</u> 14 mm Ø 0.1 - 2.25 mm	<u>23-052-17</u> 17 mm Ø 1.5 - 3.5 mm	<u>23-054-25</u> 25 mm Ø 2.0 - 5.0 mm
<u>23-056-08</u> 8 mm Ø 0.4 - 1.0 mm	<u>23-056-11</u> 11 mm Ø 0.6 - 1.5 mm	<u>23-056-14</u> 14 mm Ø 1.0 - 2.25 mm		



23-058-00
Acland Clip Applying Forcep
 Overall Length 14.5 cm (5 3/4")

Operating Scissors
 Chirurgische Scheren
 Tijeras quirúrgicas
 Ciseaux chirurgicaux
 Forbici per chirurgia

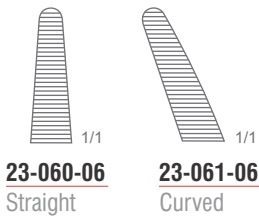

Biemer Clip Applying Forcep
 Overall Length 6 cm (2 ¼")

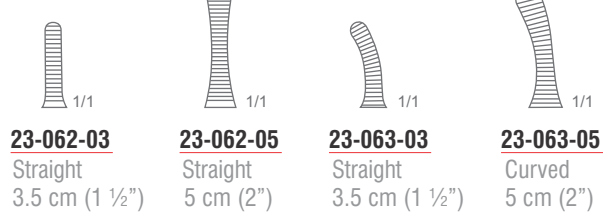

Biemer Clip Applying Forcep
 Overall Length 6 cm (2 ¼")



John-Hopkins Bulldog Clamp

Codes	Overall Length	Jaw Length
<u>23-065-35</u>	3.5 cm (1 ½")	12 mm
<u>23-065-50</u>	5 cm (2")	17 mm
<u>23-065-55</u>	5.5 cm (2 ⅛")	25 mm
<u>23-065-65</u>	6.5 cm (2 ½")	30 mm
<u>23-065-70</u>	7 cm (2 ¾")	33 mm
<u>23-065-80</u>	8 cm (3 ¼")	42 mm
<u>23-065-90</u>	9 cm (3 ½")	52 mm



23-067-24
John-Hopkins Clip Applying Forcep
 Overall Length 24 cm (9 ½")

Operating Scissors
Chirurgische Scheren
Tijeras quirúrgicas
Ciseaux chirurgicaux
Forbici per chirurgia



23-080-45
Straight
45 mm, 8 mm

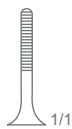

23-080-50
Straight
50 mm, 12 mm

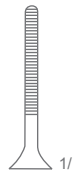

23-080-60
Straight
60 mm, 20 mm

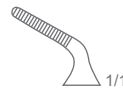
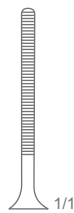

23-081-40
Angled
45 mm, 8 mm

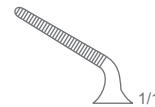

23-081-45
Angled
50 mm, 12 mm

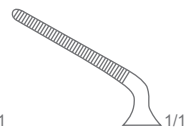

23-081-50
Angled
60 mm, 20 mm

Diethrich Bulldog Clamp



23-084-10
Straight
45 mm, 10 mm

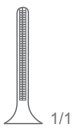

23-084-14
Straight
50 mm, 14 mm

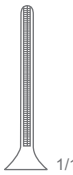

23-084-20
Straight
60 mm, 20 mm

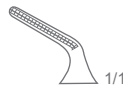
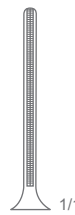

23-085-10
Angled
35 mm, 10 mm

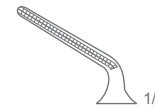

23-085-14
Angled
45 mm, 14 mm

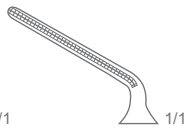

23-085-20
Angled
50 mm, 20 mm

DeBaKey-Diethrich Atrauma Bulldog Clamp

Operating Scissors
 Chirurgische Scheren
 Tijeras quirúrgicas
 Ciseaux chirurgicaux
 Forbici per chirurgia

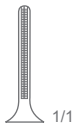

23-084-10 T
 Straight
 45 mm, 10 mm

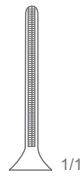

23-084-14 T
 Straight
 50 mm, 14 mm

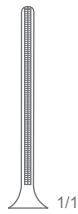

23-084-20 T
 Straight
 60 mm, 20 mm

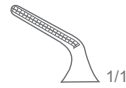

23-085-10 T
 Angled
 35 mm, 10 mm

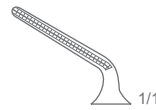

23-085-14 T
 Angled
 45 mm, 14 mm

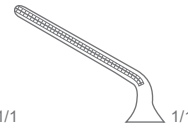

23-085-20 T
 Angled
 50 mm, 20 mm

DeBakey-Diethrich Atrauma Bulldog Clamp
 Titanium

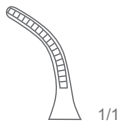

23-087-10
 35 mm, 10 mm

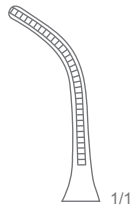

23-087-20
 50 mm, 10 mm

DeBakey-Diethrich Atrauma Bulldog Clamp
 Curved



23-089-35
 35 mm, 10 mm

23-089-40
 40 mm, 10 mm

DeBakey-Hess Bulldog Clamp

Operating Scissors
 Chirurgische Scheren
 Tijeras quirúrgicas
 Ciseaux chirurgicaux
 Forbici per chirurgia



**Mini-Glover Vena Atrauma
 Bulldog Clamp**



23-090-30 T
 Straight
 30 mm, 9 mm

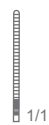

23-090-35 T
 Straight
 35 mm, 13 mm



23-090-40 T
 Straight
 40 mm, 14 mm

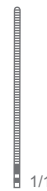

23-090-50 T
 Straight
 50 mm, 23 mm



23-091-30 T
 Gently Curved
 30 mm, 9 mm



23-091-35 T
 Gently Curved
 35 mm, 13 mm

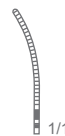

23-091-40 T
 Gently Curved
 40 mm, 14 mm



23-091-50 T
 Gently Curved
 50 mm, 23 mm



23-093-30 T
 Strongly Curved
 30 mm, 9 mm

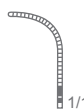

23-093-35 T
 Strongly Curved
 35 mm, 13 mm

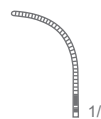

23-093-40 T
 Strongly Curved
 40 mm, 14 mm

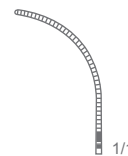

23-093-50 T
 Strongly Curved
 50 mm, 23 mm

Operating Scissors
 Chirurgische Scheren
 Tijeras quirúrgicas
 Ciseaux chirurgicaux
 Forbici per chirurgia

THORAX, CARDIOVASCULAR SURGERY



Mini-Glover Arteria Atrauma
 Bulldog Clamp



23-096-30 T
 Straight
 30 mm, 9 mm

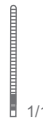

23-096-35 T
 Straight
 35 mm, 13 mm

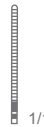

23-096-40 T
 Straight
 40 mm, 14 mm



23-096-50 T
 Straight
 50 mm, 23 mm



23-097-30 T
 Gently Curved
 30 mm, 9 mm

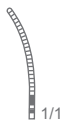

23-097-35 T
 Gently Curved
 35 mm, 13 mm

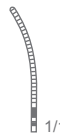

23-097-40 T
 Gently Curved
 40 mm, 14 mm

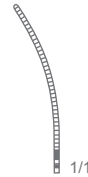

23-097-50 T
 Gently Curved
 50 mm, 22 mm



23-099-30 T
 Strongly Curved
 30 mm, 9 mm

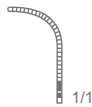

23-099-35 T
 Strongly Curved
 35 mm, 14 mm

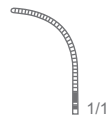

23-099-40 T
 Strongly Curved
 40 mm, 15 mm

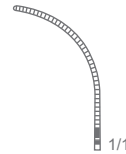

23-099-50 T
 Strongly Curved
 50 mm, 21 mm



Operating Scissors
 Chirurgische Scheren
 Tijeras quirúrgicas
 Ciseaux chirurgicaux
 Forbici per chirurgia



Pean Haemostatic Forcep



23-110-14
 Straight
 14.5 cm (5 3/4")



23-110-16
 Straight
 16 cm (6 1/4")

23-111-14
 Curved
 14.5 cm (5 3/4")

23-111-16
 Curved
 16 cm (6 1/4")



23-112-13
Korenlein Haemostatic Forcep
 Overall Length 13 cm (5")



Operating Scissors
 Chirurgische Scheren
 Tijeras quirúrgicas
 Ciseaux chirurgicaux
 Forbici per chirurgia

THORAX, CARDIOVASCULAR SURGERY

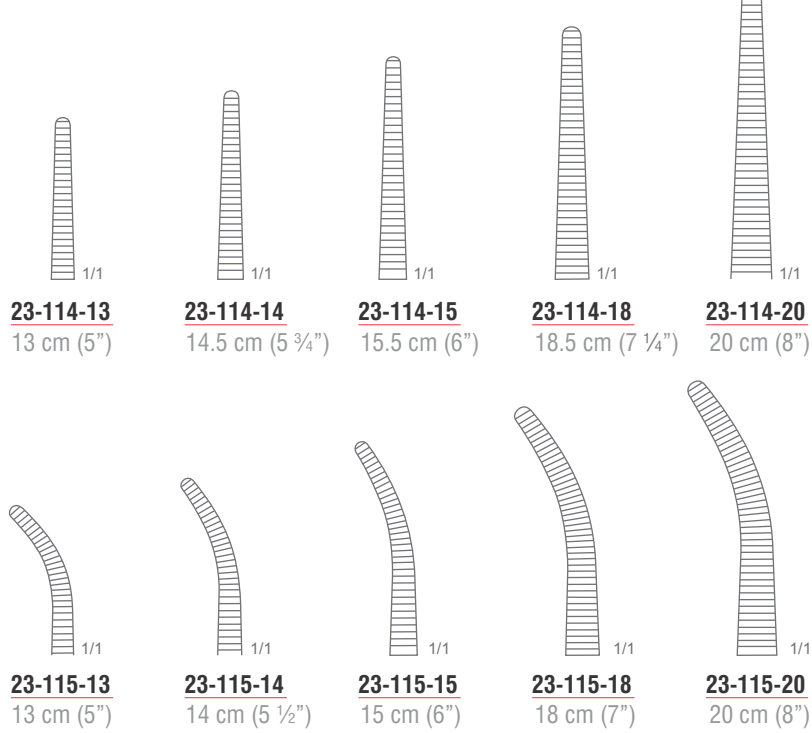

Spencer-Wells Haemostatic Forcep



23-120-13
Chaput Haemostatic Forcep
 2 x 3 Teeth
 Overall Length 12.5 cm (5")

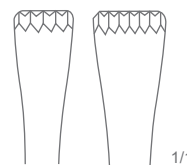

23-122-13
Tuffier Haemostatic Forcep
 4 x 5 Teeth
 Overall Length 12.5 cm (5")



Operating Scissors
Chirurgische Scheren
Tijeras quirúrgicas
Ciseaux chirurgicaux
Forbici per chirurgia



23-126-25
25 cm (9 3/4")

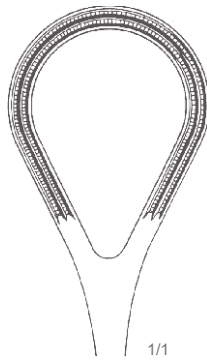

23-126-26
26 cm (10 1/4")

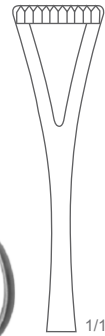

23-128-14
Collin Organ Grasping Forcep
Overall Length 14 cm (5 1/2")

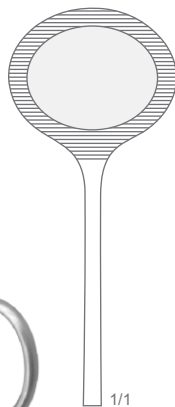
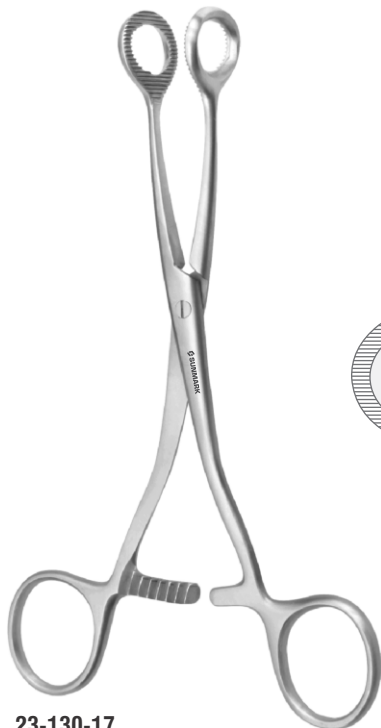

23-130-17
Collin Tumor Grasping Forcep
Overall Length 17 cm (6 3/4")

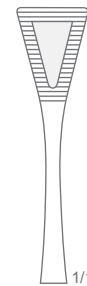

23-134-15
15.5 cm (6")

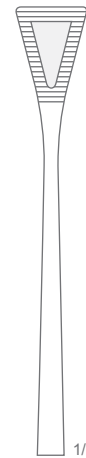

23-134-20
21 cm (8 1/4")

Pennington Organ Grasping Forcep

Operating Scissors
Chirurgische Scheren
Tijeras quirúrgicas
Ciseaux chirurgicaux
Forbici per chirurgia



23-136-15
Pratt Haemostatic Forcep
Overall Length 15 cm (6")

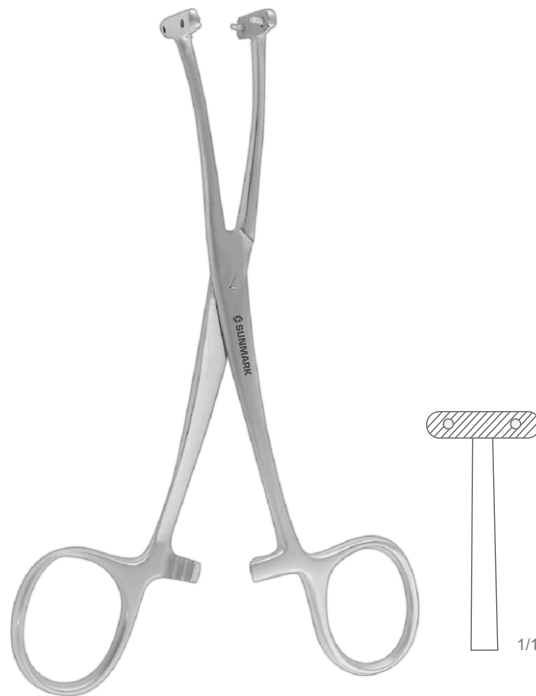

23-138-14
Martel-Rees Face-Lift Forcep
Overall Length 13.5 cm (5 1/4")



Hartmann Haemostatic Forcep

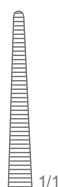

23-140-10
Straight
10 cm (4")

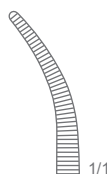

23-141-10
Curved
9.5 cm (3 3/4")



23-142-10
Straight
1 x 2 Teeth
10 cm (4")

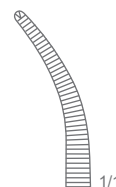

23-143-10
Curved
1 x 2 Teeth
9.5 cm (3 3/4")

Operating Scissors
Chirurgische Scheren
Tijeras quirúrgicas
Ciseaux chirurgicaux
Forbici per chirurgia



23-146-12
Haemostatic Forcep
Cross Serrated Jaw
Overall Length 12.5 cm (5")



23-148-08
Carrel Haemostatic Forcep
Overall Length 8.5 cm (3 1/4")



23-150-08
Terrier Haemostatic Forcep
1 x 2 Teeth
Overall Length 8.5 cm (3 1/4")

9
8
7
6
5
4
3
2
1
INCHES
220
210
200
190
180
170
160
150
140
130
120
110
100
90
80
70
60
50
40
30
20
10
MILLIMETERS

Operating Scissors
 Chirurgische Scheren
 Tijeras quirúrgicas
 Ciseaux chirurgicaux
 Forbici per chirurgia

THORAX, CARDIOVASCULAR SURGERY



Halsted-Mosquito Haemostatic Forcep

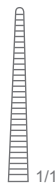

23-160-12
 Straight
 12.5 cm (4 3/4")



23-160-14
 Straight
 14.5 cm (5 1/2")

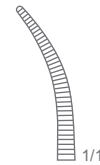

23-161-12
 Curved
 12 cm (4 3/4")

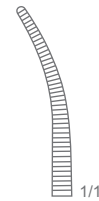

23-161-14
 Curved
 14 cm (5 1/2")



23-162-12
 Straight
 1 x 2 Teeth
 12.5 cm (4 3/4")



23-162-14
 Straight
 1 x 2 Teeth
 14.5 cm (5 1/2")

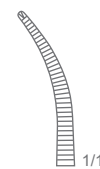

23-163-12
 Curved
 1 x 2 Teeth
 12 cm (4 3/4")

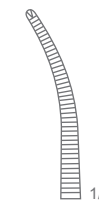

23-163-14
 Curved
 1 x 2 Teeth
 14 cm (5 1/2")



1:2



Micro-Mosquito Haemostatic Forcep

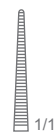

23-170-10
 Straight
 10 cm (4")

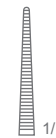

23-170-12
 Straight
 12 cm (4 3/4")

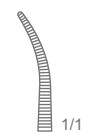

23-171-10
 Curved
 9.5 cm (3 3/4")

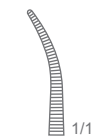

23-171-12
 Curved
 11.5 cm (4 1/2")



23-172-10
 Straight
 1 x 2 Teeth
 10 cm (4")

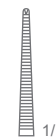

23-172-12
 Straight
 1 x 2 Teeth
 12 cm (4 3/4")

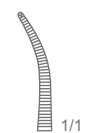

23-173-10
 Curved
 1 x 2 Teeth
 10 cm (4")

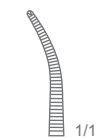

23-173-12
 Curved
 1 x 2 Teeth
 12 cm (4 3/4")



1:2

Operating Scissors
 Chirurgische Scheren
 Tijeras quirúrgicas
 Ciseaux chirurgicaux
 Forbici per chirurgia



Halsted-Mosquito Haemostatic Forcep

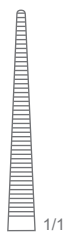

23-176-18
 Straight
 18.5 cm (7 1/4")



23-176-21
 Straight
 21 cm (8 1/4")

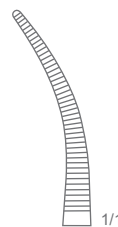

23-177-18
 Curved
 18 cm (7")

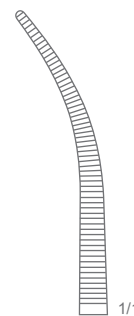

23-177-21
 Curved
 20.5 cm (8")

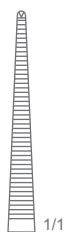

23-178-18
 Straight
 1 x 2 Teeth
 18.5 cm (7 1/4")

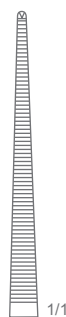

23-178-21
 Straight
 1 x 2 Teeth
 21 cm (8 1/4")

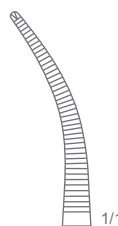

23-179-18
 Curved
 1 x 2 Teeth
 18 cm (7")

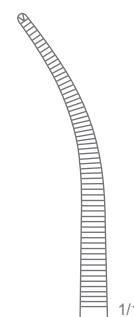

23-179-21
 Curved
 1 x 2 Teeth
 21 cm (8")



Providence-Hospital Haemostatic Forcep



23-182-14
 Straight
 14 cm (5 1/2")

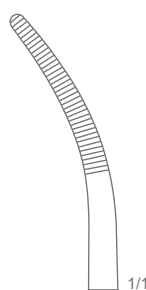

23-183-14
 Curved
 14 cm (5 1/2")

Operating Scissors
Chirurgische Scheren
Tijeras quirúrgicas
Ciseaux chirurgicaux
Forbici per chirurgia



Leriche Haemostatic Forcep

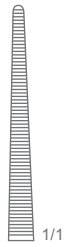

23-184-15
Straight
15.5 cm (6")

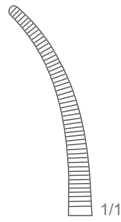

23-185-15
Curved
15 cm (6")



23-186-15
Straight
1 x 2 Teeth
15.5 cm (6")

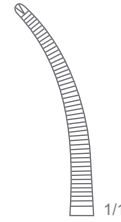

23-187-15
Curved
1 x 2 Teeth
15 cm (6")



Kelly Haemostatic Forcep



23-200-14
14.5 cm (5 3/4")

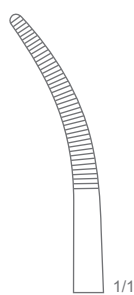

23-201-14
14.5 cm (5 3/4")

Operating Scissors
 Chirurgische Scheren
 Tijeras quirúrgicas
 Ciseaux chirurgicaux
 Forbici per chirurgia



Kelly-Rankin Haemostatic Forcep

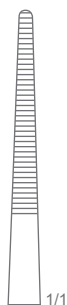

23-202-16
 Straight
 16 cm (6 1/4")

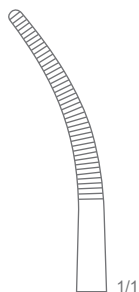

23-203-16
 Curved
 15.5 cm (6")



Kelly-Rankin Haemostatic Forcep



23-210-14
 Straight
 14.5 cm (5 3/4")

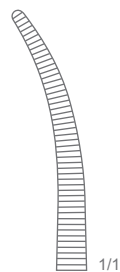

23-211-14
 Curved
 14 cm (5 1/2")



23-212-14
 Straight
 1 x 2 Teeth
 14.5 cm (5 3/4")

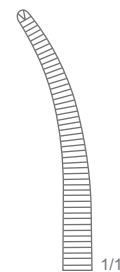

23-213-14
 Curved
 1 x 2 Teeth
 14 cm (5 1/2")

Operating Scissors
Chirurgische Scheren
Tijeras quirúrgicas
Ciseaux chirurgicaux
Forbici per chirurgia

THORAX, CARDIOVASCULAR SURGERY



Crile-Rankin Haemostatic Forcep
Overall Length 17 cm (6 3/4")

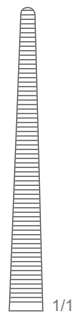

23-214-16
Straight

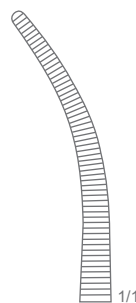

23-215-16
Curved

Operating Scissors
Chirurgische Scheren
Tijeras quirúrgicas
Ciseaux chirurgicaux
Forbici per chirurgia



23-220-14
14.5 cm (5 3/4")



23-220-16
16.5 cm (6 1/2")

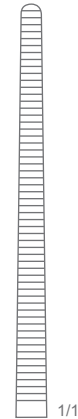

23-220-18
18.5 cm (7 1/4")

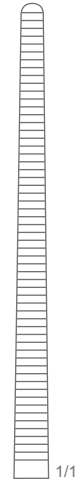

23-220-20
20.5 cm (8")



Rochester-Pean Haemostatic Forcep
Straight



23-220-22
22.5 cm (8 3/4")

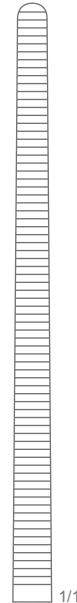

23-220-24
24.5 cm (9 3/4")



23-220-26
26 cm (10 1/4")



23-220-30
30.5 cm (12")

Operating Scissors
Chirurgische Scheren
Tijeras quirúrgicas
Ciseaux chirurgicaux
Forbici per chirurgia

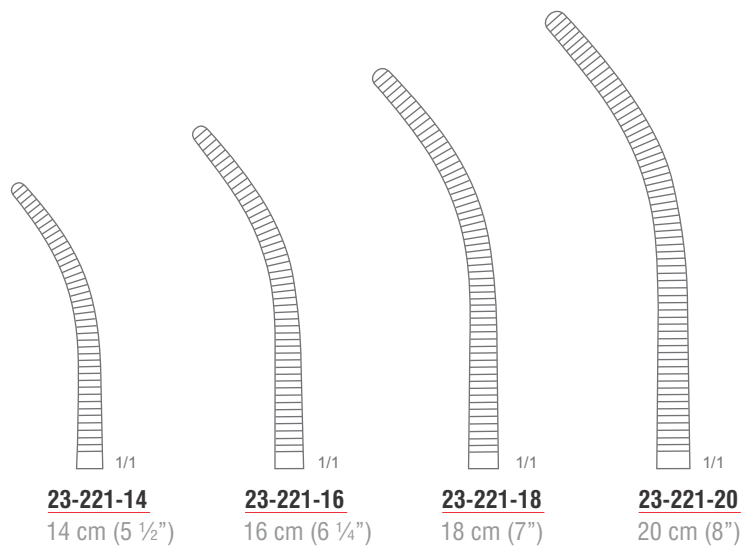

Rochester-Pean Haemostatic Forcep
Curved

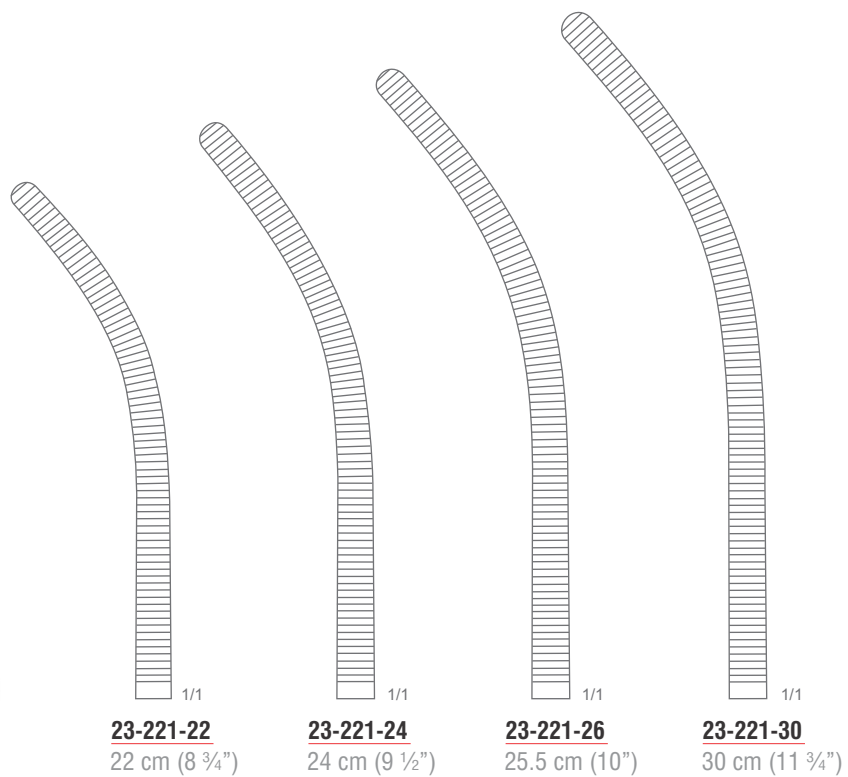

Operating Scissors
 Chirurgische Scheren
 Tijeras quirúrgicas
 Ciseaux chirurgicaux
 Forbici per chirurgia

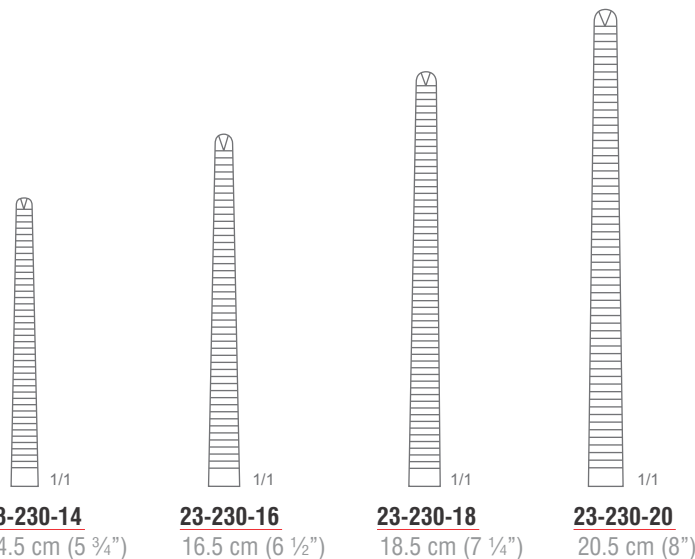

Rochester-Kocher Haemostatic Forcep
 Straight, 1 x 2 Teeth

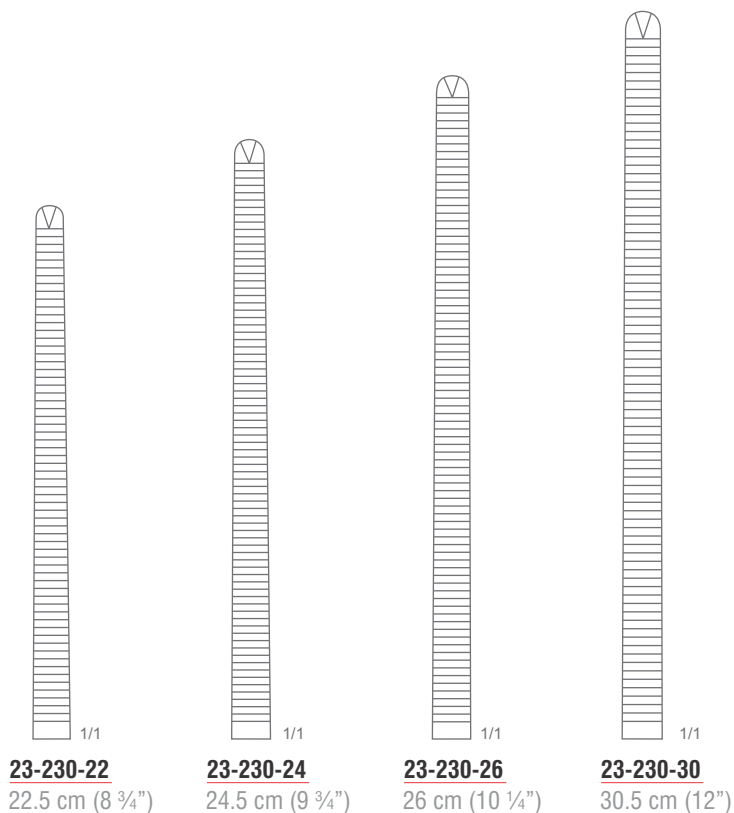

Operating Scissors
 Chirurgische Scheren
 Tijeras quirúrgicas
 Ciseaux chirurgicaux
 Forbici per chirurgia

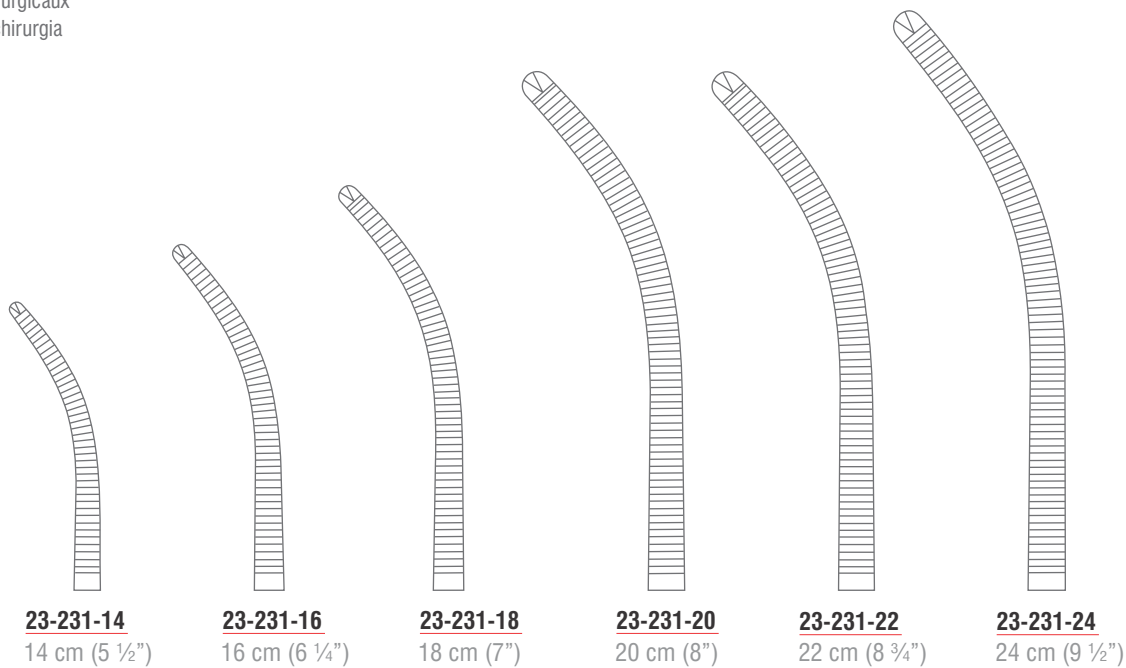

Rochester-Kocher Haemostatic Forcep
 Curved, 1 x 2 Teeth

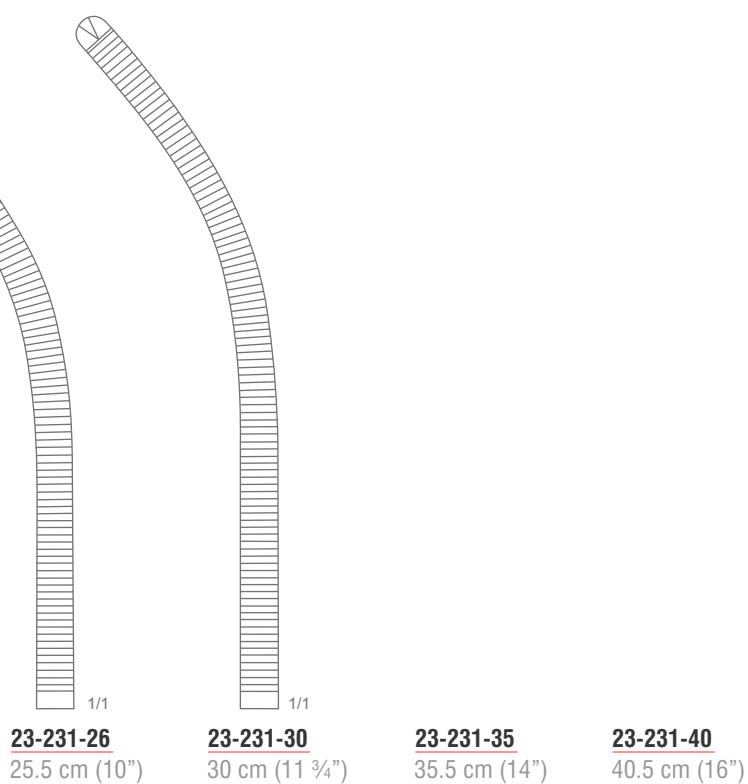

1:2



Operating Scissors
Chirurgische Scheren
Tijeras quirúrgicas
Ciseaux chirurgicaux
Forbici per chirurgia



Rochester-Ochsner Haemostatic Forcep
1 x 2 Teeth
Overall Length 14 cm (5 1/2")

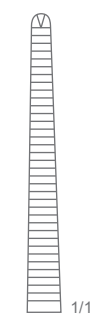

23-234-14
Straight

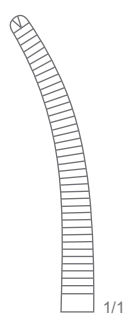

23-235-14
Curved



1:2



Kocher Haemostatic Forcep
1 x 2 Teeth
Overall Length 15 cm (6")



23-236-15
Straight

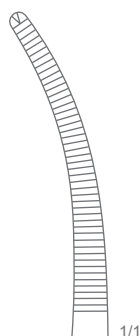

23-237-15
Curved



1:2

Operating Scissors
Chirurgische Scheren
Tijeras quirúrgicas
Ciseaux chirurgicaux
Forbici per chirurgia



Pean-Nippon Haemostatic Forcep



23-240-14
Straight
14.5 cm (5 3/4")



23-240-16
Straight
16.5 cm (6 1/2")



23-240-18
Straight
18.5 cm (7 1/4")

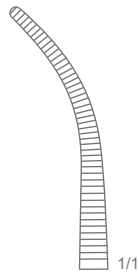

23-241-14
Curved
14 cm (5 1/2")

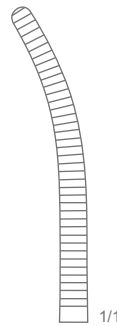

23-241-16
Curved
16 cm (6 1/4")

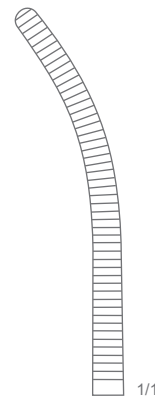

23-241-18
Curved
18 cm (7")

Operating Scissors
Chirurgische Scheren
Tijeras quirúrgicas
Ciseaux chirurgicaux
Forbici per chirurgia



Kocher-Nippon Haemostatic Forcep
1 x 2 Teeth



23-242-14
Straight
14.5 cm (5 3/4")



23-242-16
Straight
16.5 cm (6 1/2")

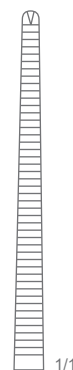

23-242-18
Straight
18.5 cm (7 1/4")

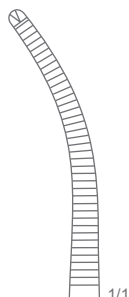

23-243-14
Curved
14.5 cm (5 3/4")

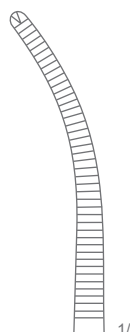

23-243-16
Curved
16 cm (6 1/4")

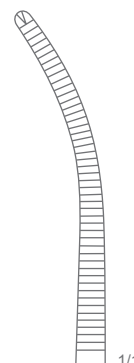

23-243-18
Curved
18 cm (7")

Operating Scissors
Chirurgische Scheren
Tijeras quirúrgicas
Ciseaux chirurgicaux
Forbici per chirurgia

THORAX, CARDIOVASCULAR SURGERY



Pean (Delicate) Haemostatic Forcep



23-246-13
Straight
13.5 cm (5 3/4")



23-246-14
Straight
14.5 cm (5 3/4")

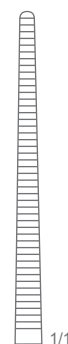

23-246-17
Straight
17 cm (6 3/4")

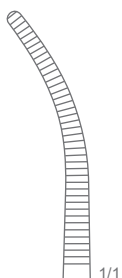

23-247-13
Curved
13 cm (5")

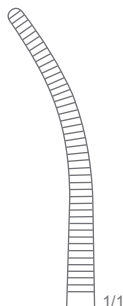

23-247-14
Curved
14 cm (5 1/2")

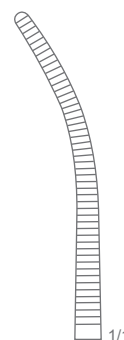

23-247-16
Curved
16.5 cm (6 1/2")

Operating Scissors
Chirurgische Scheren
Tijeras quirúrgicas
Ciseaux chirurgicaux
Forbici per chirurgia



Kocher (Delicate) Haemostatic Forcep
1 x 2 Teeth



23-248-13
Straight
13 cm (5")



23-248-14
Straight
14 cm (5 1/2")



23-248-17
Straight
16 cm (6 1/4")

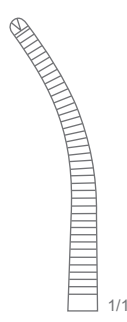

23-249-13
Curved
13 cm (5")

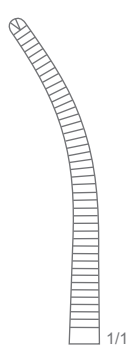

23-249-14
Curved
14 cm (5 1/2")

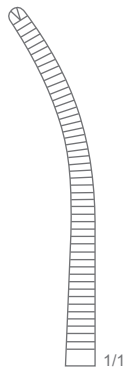

23-249-16
Curved
16 cm (6 1/4")

Operating Scissors
Chirurgische Scheren
Tijeras quirúrgicas
Ciseaux chirurgicaux
Forbici per chirurgia



Coller Haemostatic Forcep

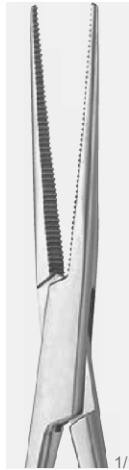

23-260-14
Straight
14 cm (5 1/2")



23-260-16
Straight
16.5 cm (6 1/2")



23-260-18
Straight
18.5 cm (7 1/4")



23-261-14
Straight
14 cm (5 1/2")

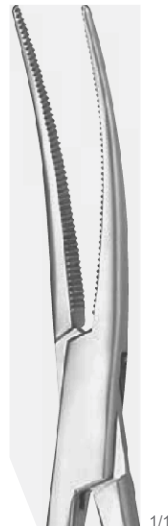

23-261-16
Straight
16.5 cm (6 1/2")

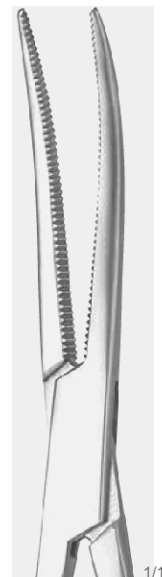

23-261-18
Straight
18.5 cm (7 1/4")

Operating Scissors
 Chirurgische Scheren
 Tijeras quirúrgicas
 Ciseaux chirurgicaux
 Forbici per chirurgia

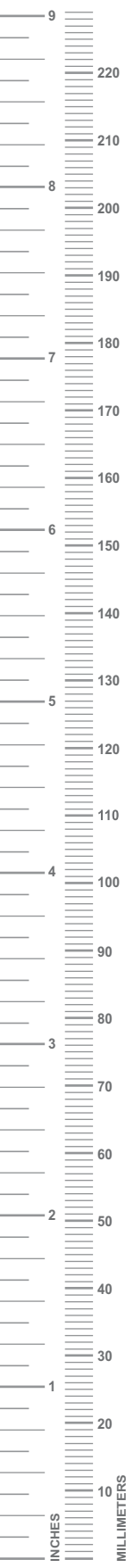

23-265-18
Fraser-Kelly (Crile) Haemostatic Forcep
 Curved
 Overall Length 18 cm (7")

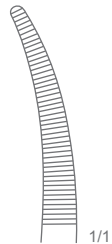

Adson Haemostatic Forcep

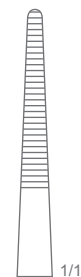

23-268-18
 Straight
 19 cm (7 1/2")

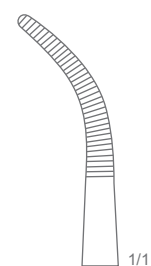

23-269-18
 Curved
 18.5 cm (7 1/4")

Operating Scissors
Chirurgische Scheren
Tijeras quirúrgicas
Ciseaux chirurgicaux
Forbici per chirurgia



23-271-21
Adson Haemostatic Forcep
Curved
Overall Length 21.5 cm (8 ½")



23-275-19
Jacobson Haemostatic Forcep
Curved
Overall Length 19 cm (7 ½")

Operating Scissors
Chirurgische Scheren
Tijeras quirúrgicas
Ciseaux chirurgicaux
Forbici per chirurgia

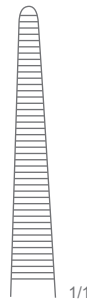

23-277-19
Dunhill Haemostatic Forcep
Straight
Overall Length 19 cm (7 ½")

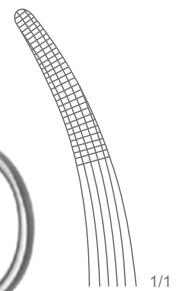

23-279-19
Grey-Turner Haemostatic Forcep
Curved
Overall Length 18 cm (7")

Operating Scissors
Chirurgische Scheren
Tijeras quirúrgicas
Ciseaux chirurgicaux
Forbici per chirurgia

THORAX, CARDIOVASCULAR SURGERY



23-281-12
Dandy-Mosquito Haemostatic Forcep
Laterally Curved, Cross Serrated
Overall Length 12 cm (4 3/4")



Dandy Haemostatic Forcep
Overall Length 14.5 cm (5 3/4")

23-283-14
Laterally Curved

23-285-14
Laterally Curved
1 x 2 Teeth



Operating Scissors
 Chirurgische Scheren
 Tijeras quirúrgicas
 Ciseaux chirurgicaux
 Forbici per chirurgia



Cairns Haemostatic Forcep
 Overall Length 15 cm (6")



23-290-15
 Straight

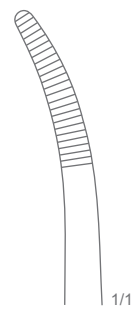

23-291-15
 Curved



23-293-14
Cairns Haemostatic Forcep
 Curved to Side
 Overall Length 14.5 cm (5 3/4")



23-295-15
Moynihan Haemostatic Forcep
 Curved
 Overall Length 15 cm (6")



Operating Scissors
Chirurgische Scheren
Tijeras quirúrgicas
Ciseaux chirurgicaux
Forbici per chirurgia

THORAX, CARDIOVASCULAR SURGERY



23-296-13
Dunhill Haemostatic Forcep
Straight
Overall Length 13 cm (5")



Lovelace Haemostatic Forcep
Straight, Cross Serrated
Overall Length 16 cm (6 1/4")

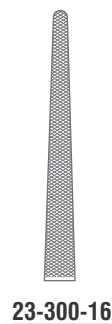

23-300-16



23-302-16
1 x 2 Teeth



Operating Scissors
Chirurgische Scheren
Tijeras quirúrgicas
Ciseaux chirurgicaux
Forbici per chirurgia



23-305-20
Martin-Fuchsig Haemostatic Forcep
Curved
Overall Length 20.5 cm (8")



23-305-20
Nissen Haemostatic Forcep
Curved
Overall Length 18.5 cm (7 1/4")

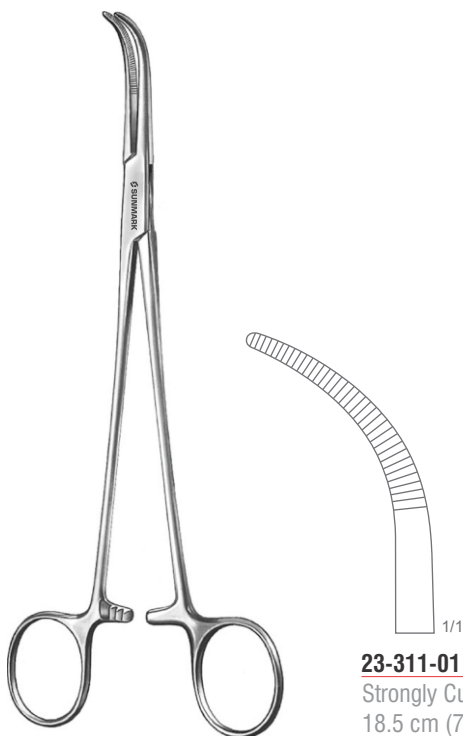

23-311-01
Strongly Curved
18.5 cm (7 1/4")

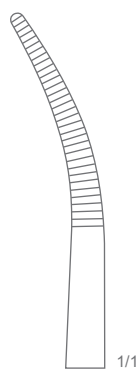

23-311-02
Gently Curved
19 cm (7 1/2")

Schnidt Tonsil Haemostatic Forcep

Operating Scissors
Chirurgische Scheren
Tijeras quirúrgicas
Ciseaux chirurgicaux
Forbici per chirurgia

THORAX, CARDIOVASCULAR SURGERY



Negus Haemostatic Forcep

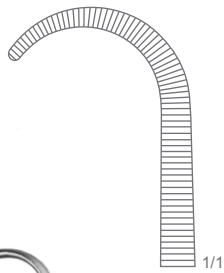

23-315-01

Fig. 1
19.5 cm (7 3/4")

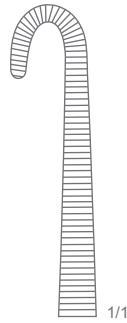

23-315-02

Fig. 2
20 cm (8")



23-317-19
Wilson Haemostatic Forcep
Curved
Overall Length 19 cm (7 1/2")



Rochester-Carmalt Haemostatic Forcep

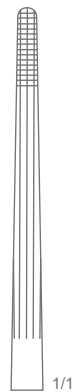

23-320-16
17 cm (6 3/4")

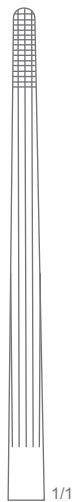

23-320-20
20.5 cm (8")

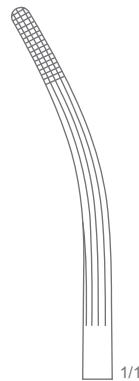

23-321-16
16.5 cm (6 1/2")

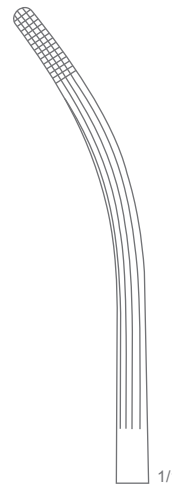

23-321-20
20 cm (8")

Operating Scissors
Chirurgische Scheren
Tijeras quirúrgicas
Ciseaux chirurgicaux
Forbici per chirurgia



Fickling Haemostatic Forcep
Overall Length 18 cm (7")

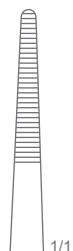

23-331-18



23-333-18
1 x 2 Teeth



Bainbridge Haemostatic Forcep
Longitudinally Serrated

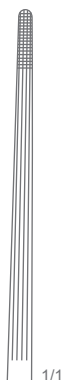

23-340-15
Straight
15 cm (6")

23-340-18
Straight
18.5 cm (7 1/4")

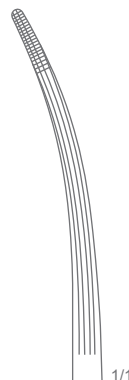

23-341-15
Curved
15 cm (6")

23-341-18
Curved
18.5 cm (7 1/4")



Operating Scissors
Chirurgische Scheren
Tijeras quirúrgicas
Ciseaux chirurgicaux
Forbici per chirurgia



23-343-25
25.5 cm (10")

23-343-28
28 cm (11")

Collier-Anderson Haemostatic Forcep
Curved



Birkett Haemostatic Forcep
Overall Length 18.5 cm (7 1/4")

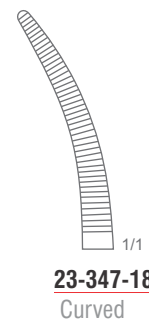
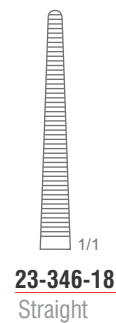

Operating Scissors
 Chirurgische Scheren
 Tijeras quirúrgicas
 Ciseaux chirurgicaux
 Forbici per chirurgia



Bengolea Haemostatic Forcep

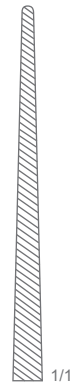

1/1

23-350-20
 Straight
 21.5 cm (8 1/2")

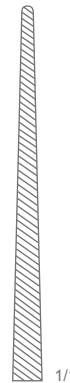

1/1

23-350-26
 Straight
 26 cm (10 1/4")

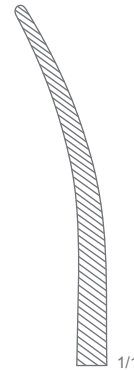

1/1

23-351-20
 Curved
 21 cm (8 1/4")

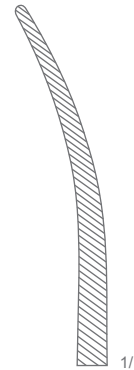

1/1

23-351-26
 Curved
 25.5 cm (10 ")

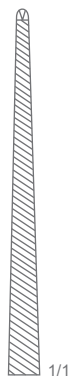

1/1

23-352-20
 Straight
 1 x 2 Teeth
 21.5 cm (8 1/2")

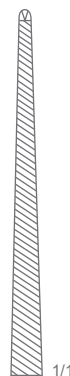

1/1

23-352-26
 Straight
 1 x 2 Teeth
 26 cm (10 1/4")

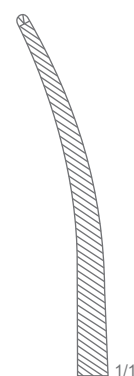

1/1

23-353-20
 Curved
 1 x 2 Teeth
 21 cm (8 1/4")

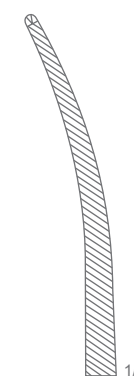

1/1

23-353-26
 Curved
 1 x 2 Teeth
 25.5 cm (10 ")

Operating Scissors
 Chirurgische Scheren
 Tijeras quirúrgicas
 Ciseaux chirurgicaux
 Forbici per chirurgia

THORAX, CARDIOVASCULAR SURGERY



Roberts Haemostatic Forcep



23-360-22
 Straight
 22.5 cm (8 ¾")

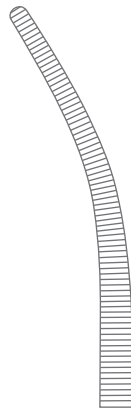

23-361-22
 Curved
 21.5 cm (8 ½")



Sarot Haemostatic Forcep



23-364-24
 Straight
 25 cm (9 ¾")

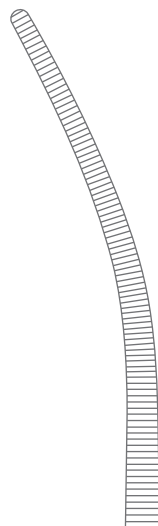

23-365-24
 Curved
 24.5 cm (9 ¾")

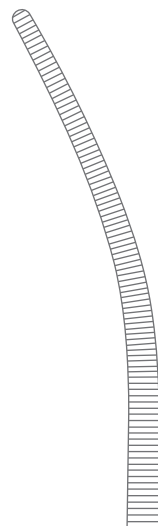

23-365-28
 Curved
 28 cm (11")

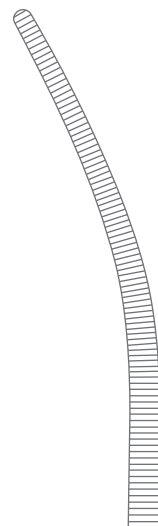

23-365-33
 Curved
 33 cm (13")

Operating Scissors
Chirurgische Scheren
Tijeras quirúrgicas
Ciseaux chirurgicaux
Forbici per chirurgia



Crafoord Haemostatic Forcep
Curved

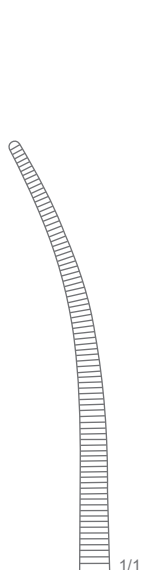

23-371-18
18 cm (7")

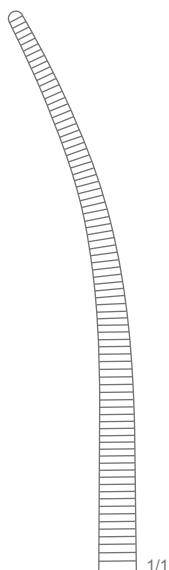

23-371-24
24.5 cm (9 3/4")



Crafoord-Sellors Haemostatic Forcep
Overall Length 24 cm (9 1/2")

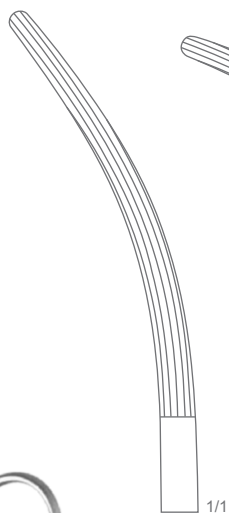

23-375-01
Fig. 1

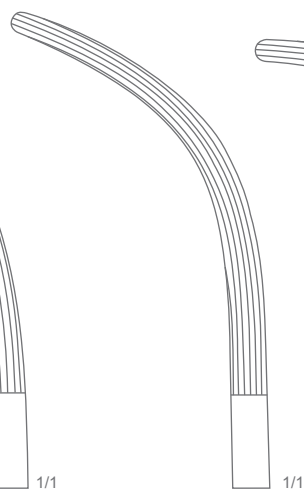

23-375-02
Fig. 2

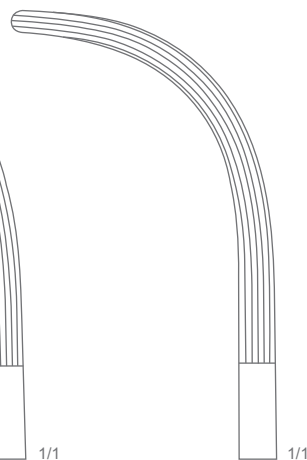

23-375-03
Fig. 3

Operating Scissors
 Chirurgische Scheren
 Tijeras quirúrgicas
 Ciseaux chirurgicaux
 Forbici per chirurgia

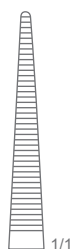

23-380-27
 Straight

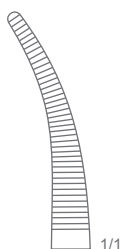

23-381-27
 Curved

Bridge Haemostatic Forcep
 Overall Length 27.5 cm (10 3/4")



23-386-20
 21 cm (8 1/4")

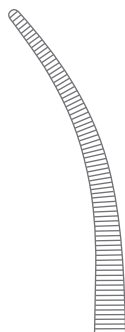

23-387-20
 20.5 cm (8")

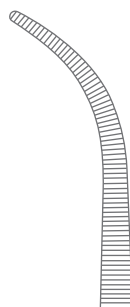

23-389-20
 20 cm (8")

Heiss Haemostatic Forcep

Operating Scissors
Chirurgische Scheren
Tijeras quirúrgicas
Ciseaux chirurgicaux
Forbici per chirurgia

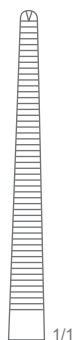

23-390-20
Straight
1 x 2 Teeth

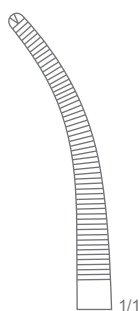

23-391-20
Curved
1 x 2 Teeth

Heiss Haemostatic Forcep
Overall Length 20 cm (8")

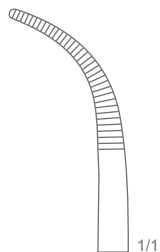

23-401-01
Fig. 1
18.5 cm (7 1/4")

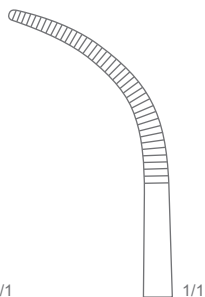

23-401-02
Fig. 2
20.5 cm (8")



23-401-03
Fig. 3
21 cm (8 1/4")

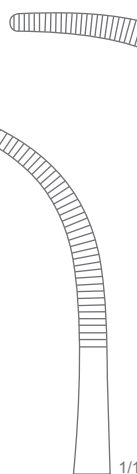

23-401-04
Fig. 4
21.5 cm (8 1/2")

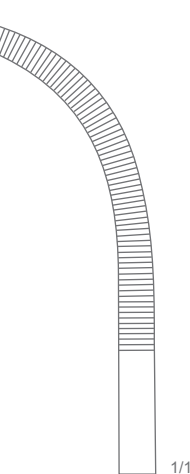

23-401-05
Fig. 5
24.5 cm (9 3/4")

Overholt-Martin Dissecting and Ligature Forcep

Operating Scissors
Chirurgische Scheren
Tijeras quirúrgicas
Ciseaux chirurgicaux
Forbici per chirurgia



23-404-12
Dissecting and Ligature Forcep
Smooth Jaws
Overall Length 12.5 cm (5")



23-405-14
Guys Galabin Suture Forcep
Angled to Side, Smooth Jaws
Overall Length 14 cm (5 1/2")

THORAX, CARDIOVASCULAR SURGERY

23-407-14
Parotid Spreading Forcep
Fine Curved
Overall Length 14 cm (5 1/2")

Operating Scissors
Chirurgische Scheren
Tijeras quirúrgicas
Ciseaux chirurgicaux
Forbici per chirurgia

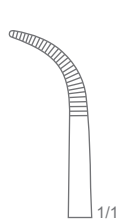

23-411-14
14.5 cm (5 3/4")

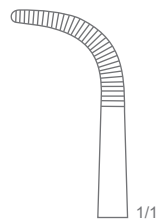

23-411-18
18 cm (7")

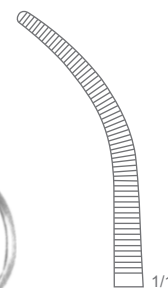

23-415-14
Overholt-Baby Dissecting and Ligature Forcep
Curved
Overall Length 14 cm (5 1/2")

Adson-Baby Dissecting and Ligature Forcep
Curved

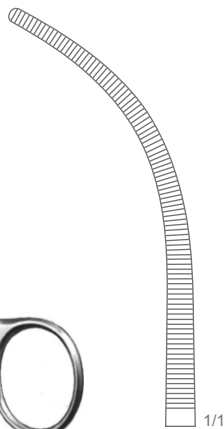
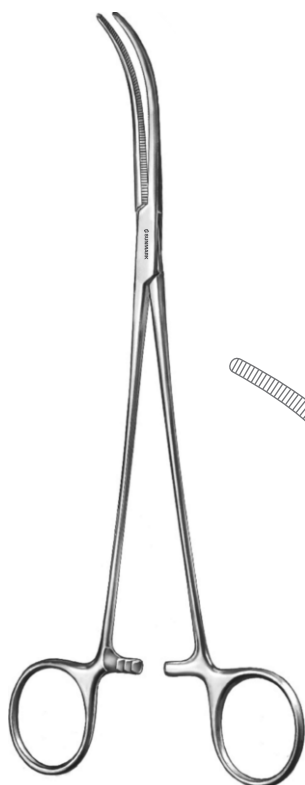

23-417-21
Overholt-Mixer Dissecting and Ligature Forcep
Curved
Overall Length 21.5 cm (8 1/2")

Operating Scissors
Chirurgische Scheren
Tijeras quirúrgicas
Ciseaux chirurgicaux
Forbici per chirurgia

THORAX, CARDIOVASCULAR SURGERY

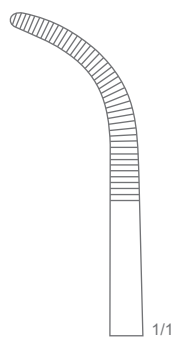

23-421-01
Fig. 1
20.5 cm (8")

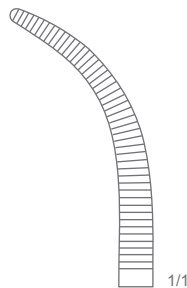

23-421-02
Fig. 2
20 cm (8")

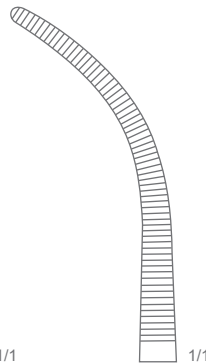

23-421-03
Fig. 3
21.5 cm (8 1/2")

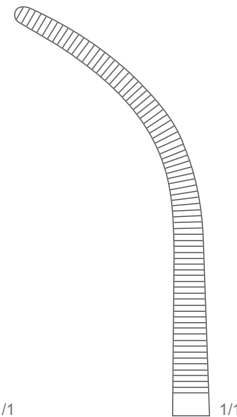

23-421-04
Fig. 4
22 cm (8 3/4")

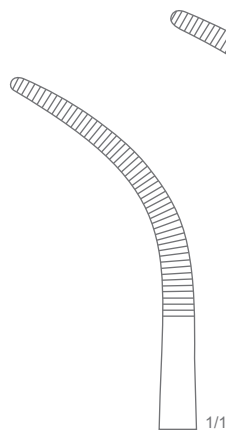

23-421-05
Fig. 5
21.5 cm (8 1/2")

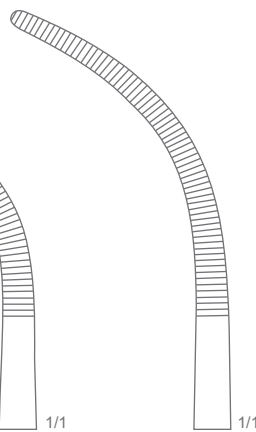

23-421-06
Fig. 6
22 cm (8 3/4")

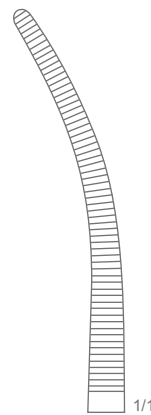

23-421-07
Fig. 7
22 cm (8 3/4")

Overholt-Geissendoerfer Dissecting and Ligature Forcep

Operating Scissors
 Chirurgische Scheren
 Tijeras quirúrgicas
 Ciseaux chirurgicaux
 Forbici per chirurgia



Overholt-Geissendoerfer Dissecting and Ligature Forcep

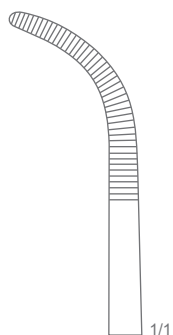

23-423-01
 Fig. 1
 27 cm (10 3/4")

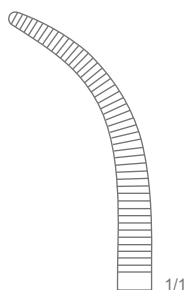

23-423-02
 Fig. 2
 26.5 cm (10 1/2")

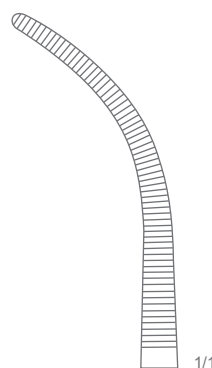

23-423-03
 Fig. 3
 27.5 cm (10 3/4")

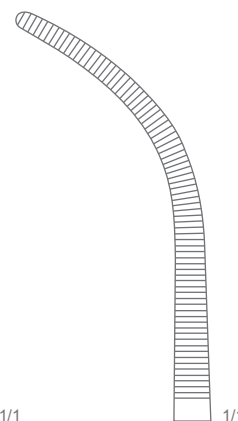

23-423-04
 Fig. 4
 28 cm (11")

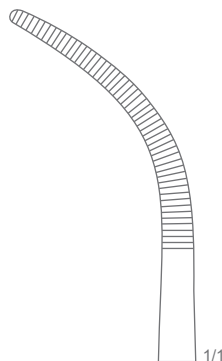

23-423-05
 Fig. 5
 27.5 cm (10 3/4")

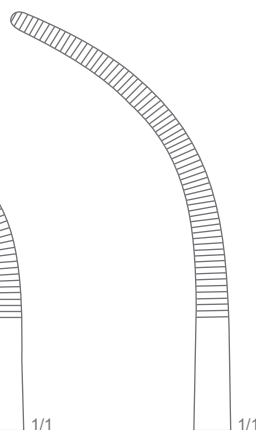

23-423-06
 Fig. 6
 28 cm (11")

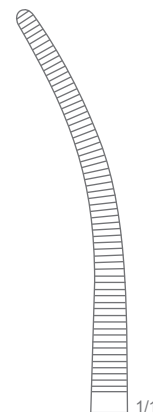

23-423-07
 Fig. 7
 27.5 cm (10 3/4")

Operating Scissors
Chirurgische Scheren
Tijeras quirúrgicas
Ciseaux chirurgicaux
Forbici per chirurgia

THORAX, CARDIOVASCULAR SURGERY

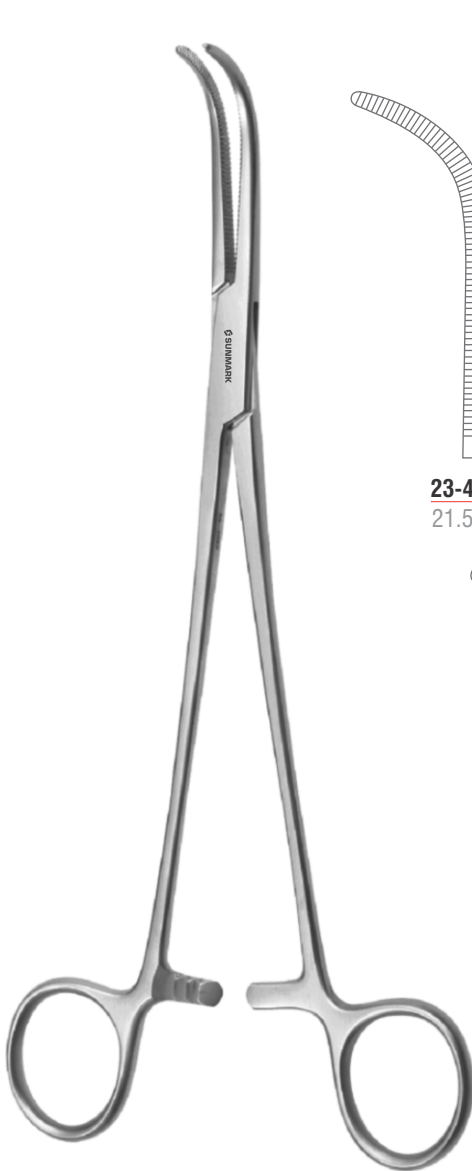

Overholt-Fine Dissecting and Ligature Forcep
Curved

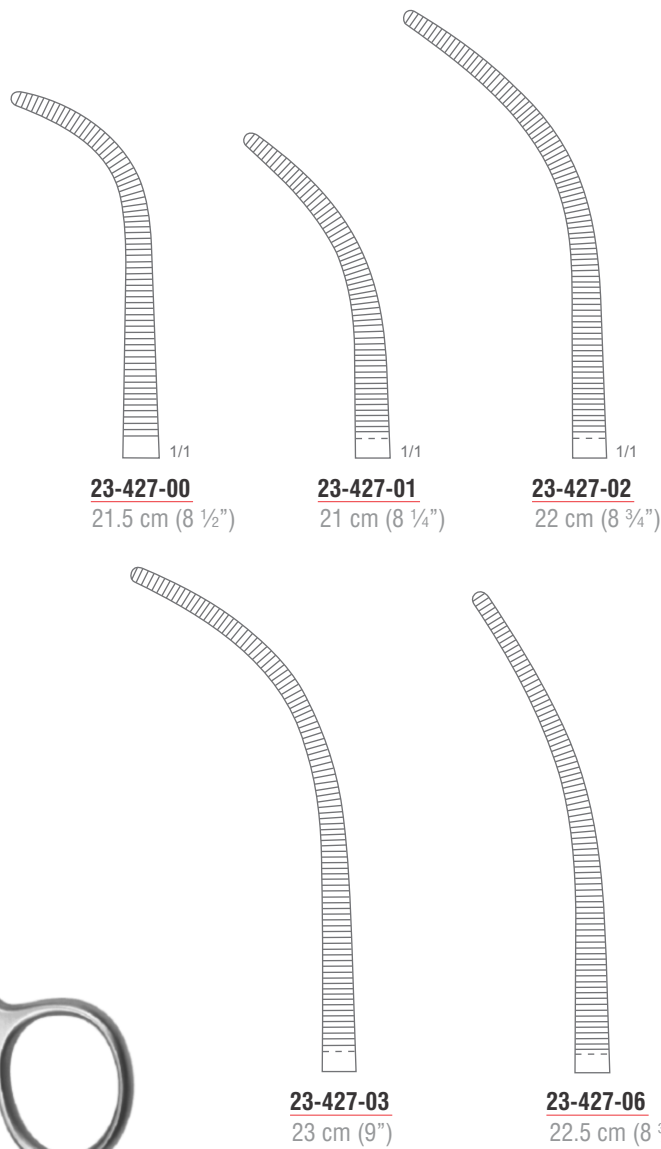

Operating Scissors
 Chirurgische Scheren
 Tijeras quirúrgicas
 Ciseaux chirurgicaux
 Forbici per chirurgia

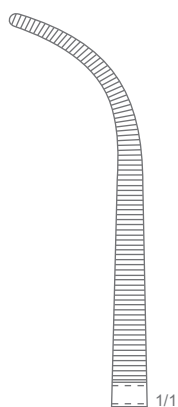

23-429-00
 29 cm (11 1/2")

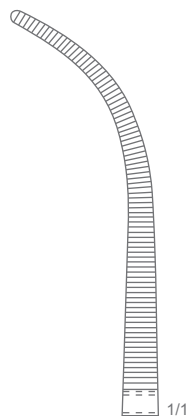

23-429-01
 29 cm (11 1/2")

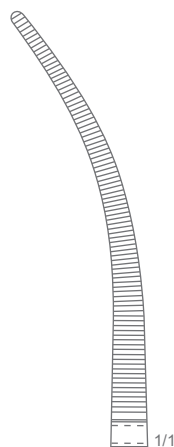

23-429-02
 30 cm (11 3/4")

Overholt Dissecting and Ligature Forcep
 Curved

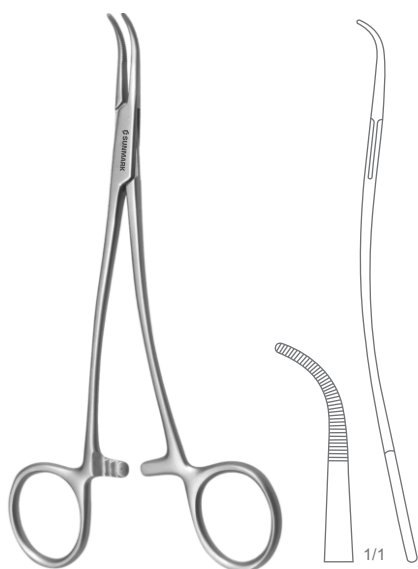

23-431-15
Overholt-Mini Dissecting and Ligature Forcep
 Curved, S Shaped
 Overall Length 15 cm (6")

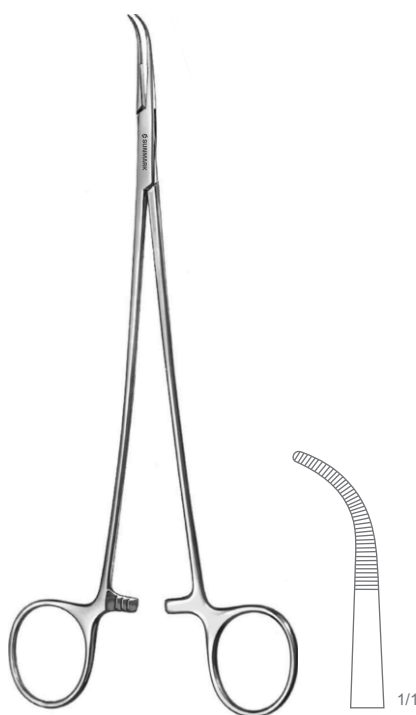

23-433-20
Overholt-Mini Dissecting and Ligature Forcep
 Curved
 Overall Length 20 cm (8")

Operating Scissors
Chirurgische Scheren
Tijeras quirúrgicas
Ciseaux chirurgicaux
Forbici per chirurgia

THORAX, CARDIOVASCULAR SURGERY

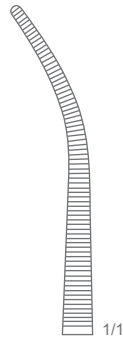

23-441-19

Fig. 1
19.5 cm (7 3/4")

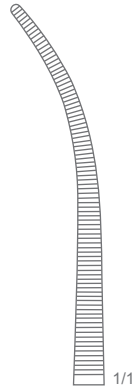

23-441-22

Fig. 1
22.5 cm (8 3/4")

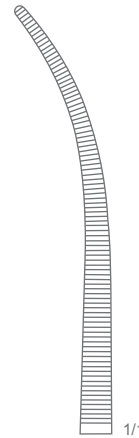

23-441-24

Fig. 1
24.5 cm (9 3/4")

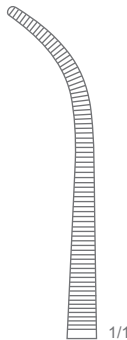

23-443-19

Fig. 2
19 cm (7 1/2")

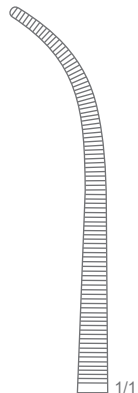

23-443-22

Fig. 2
22 cm (8 3/4")

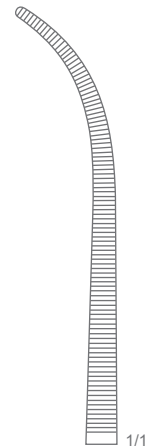

23-443-24

Fig. 2
24 cm (9 1/2")

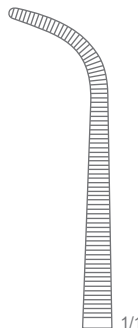

23-445-19

Fig. 3
18.5 cm (7 1/4")

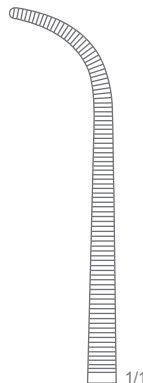

23-445-22

Fig. 3
21.5 cm (8 1/2")

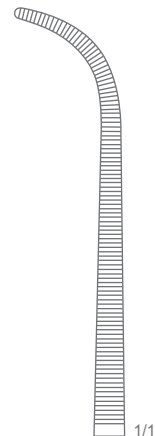

23-445-24

Fig. 3
23.5 cm (9 1/4")



Kelly Dissecting and Ligature Forcep

Operating Scissors
Chirurgische Scheren
Tijeras quirúrgicas
Ciseaux chirurgicaux
Forbici per chirurgia

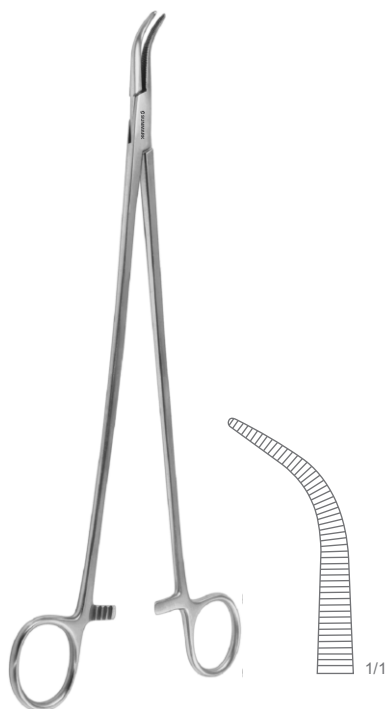

23-451-28
Lawrence Dissecting and Ligature Forcep
Curved
Overall Length 28 cm (11")



23-455-28
Meeker Dissecting and Ligature Forcep
Right Angled
Overall Length 28 cm (11")

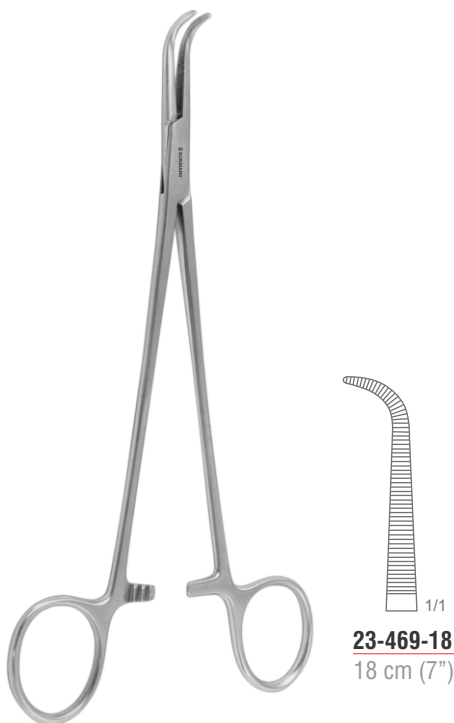

23-469-18
18 cm (7")

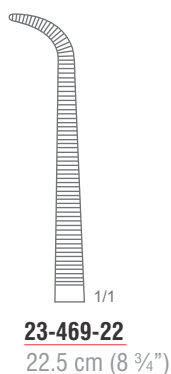

23-469-22
22.5 cm (8 3/4")

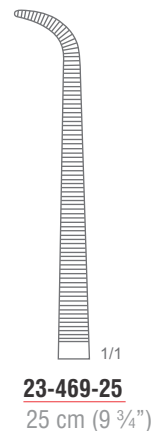

23-469-25
25 cm (9 3/4")

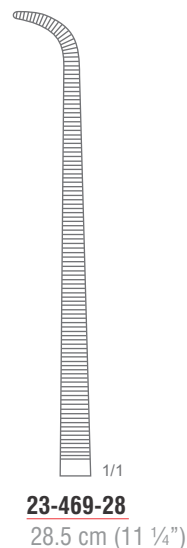

23-469-28
28.5 cm (11 1/4")

Mini-Gemini Dissecting and Ligature Forcep
Curved

Operating Scissors
Chirurgische Scheren
Tijeras quirúrgicas
Ciseaux chirurgicaux
Forbici per chirurgia

THORAX, CARDIOVASCULAR SURGERY



Gemini Dissecting and Ligature Forcep
Curved

Operating Scissors
Chirurgische Scheren
Tijeras quirúrgicas
Ciseaux chirurgicaux
Forbici per chirurgia

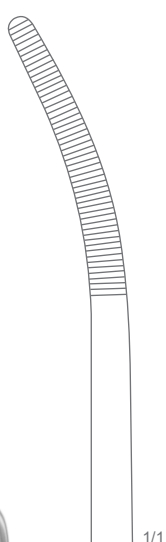

23-475-01
24 cm (9 1/2")

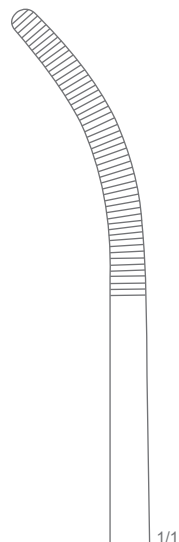

23-475-02
23.5 cm (9 1/2")

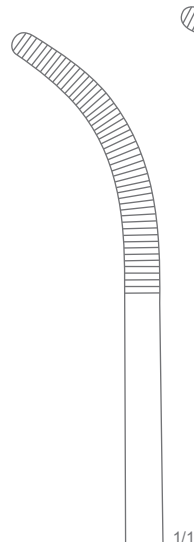

23-475-03
23 cm (9")

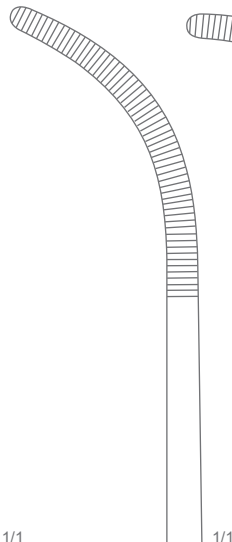

23-475-04
24 cm (9 1/2")

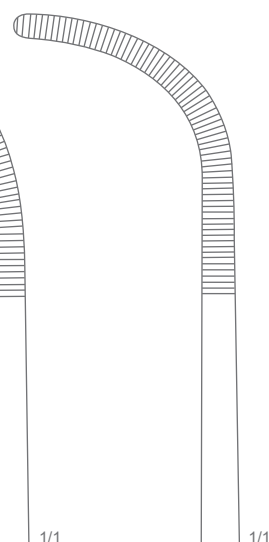

23-475-05
23.5 cm (9 1/4")

Rumel Dissecting and Ligature Forcep
Curved

Operating Scissors
Chirurgische Scheren
Tijeras quirúrgicas
Ciseaux chirurgicaux
Forbici per chirurgia

THORAX, CARDIOVASCULAR SURGERY

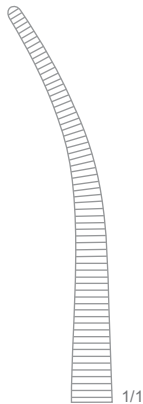

23-479-01
29.5 cm (11 1/2")

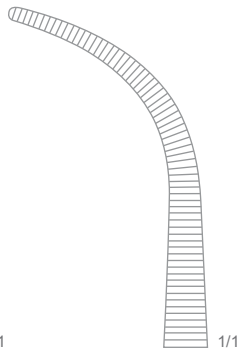

23-479-02
28.5 cm (11 1/4")

Zenker Dissecting and Ligature Forcep
Curved

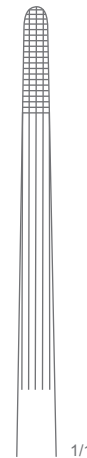

23-481-23
Kieback Dissecting and Ligature Forcep
Curved
Overall Length 23.5 cm (9 1/4")



23-491-01
Gently Curved
13.5 cm (5 1/4")

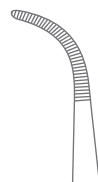

23-491-02
Strongly Curved
13 cm (5")

Mixer-Baby Dissecting and Ligature Forcep

Operating Scissors
Chirurgische Scheren
Tijeras quirúrgicas
Ciseaux chirurgicaux
Forbici per chirurgia



23-493-14
Mixer-Baby Dissecting and Ligature Forcep
Curved
Overall Length 13.5 cm (5 1/4")



23-495-18
Mixer-Baby Dissecting and Ligature Forcep
Curved
Overall Length 18.5 cm (7 1/4")



Mixer Dissecting and Ligature Forcep
Right Angled

23-497-15
16 cm (6 1/4")

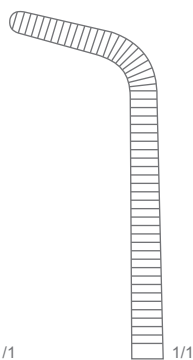

23-497-19
18 cm (7")



Mixer Dissecting and Ligature Forcep
Curved

23-499-22
22.5 cm (8 3/4")

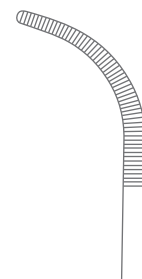

23-499-23
23 cm (9")

Operating Scissors
 Chirurgische Scheren
 Tijeras quirúrgicas
 Ciseaux chirurgicaux
 Forbici per chirurgia

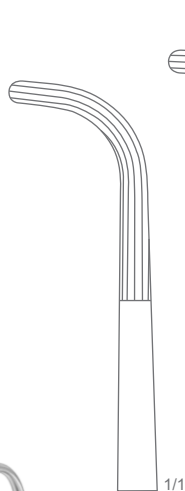

23-501-22
 22.5 cm (8 3/4")

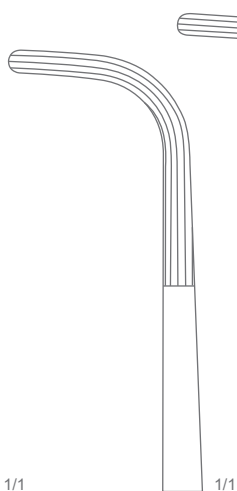

23-501-25
 26 cm (10 1/4")

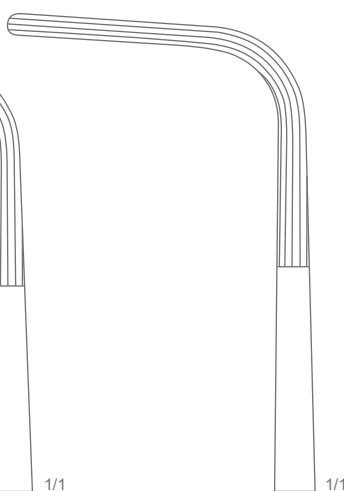

23-501-28
 28 cm (11")

Mixer Dissecting and Ligature Forcep
 Right Angled, Longitudinally Serrated

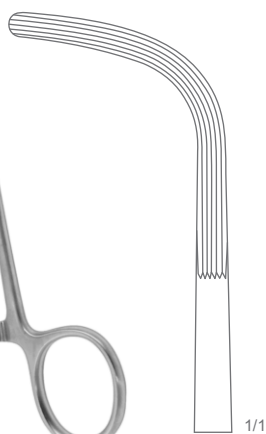

23-505-22
McQuigg-Mixer Dissecting and Ligature Forcep
 Right Angled, Longitudinally Serrated
 Overall Length 23.5 cm (9 1/4")

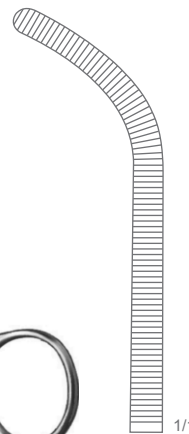

23-509-19
Mixer-O'SHAUGHNESSY Dissecting and Ligature Forcep
 Curved
 Overall Length 18.5 cm (7")

Operating Scissors
Chirurgische Scheren
Tijeras quirúrgicas
Ciseaux chirurgicaux
Forbici per chirurgia



O'Shaughnessy Dissecting and Ligature Forcep
Curved

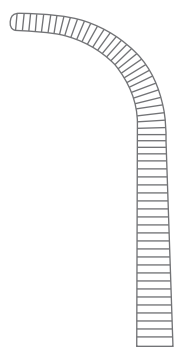

23-511-14
15 cm (6")

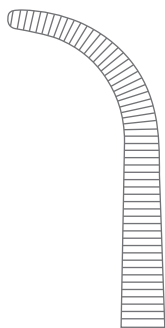

23-511-17
18 cm (7")



23-511-20
20 cm (8")

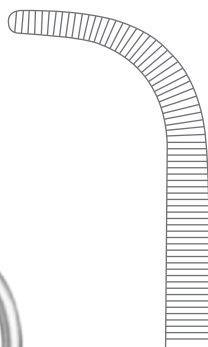

23-511-23
23 cm (9")

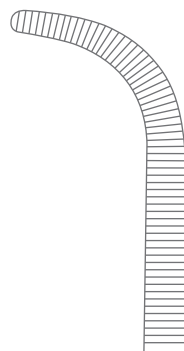

23-511-26
26 cm (10 1/4")

Operating Scissors
Chirurgische Scheren
Tijeras quirúrgicas
Ciseaux chirurgicaux
Forbici per chirurgia



Wickstroem Dissecting and Ligature Forcep
Right Angled

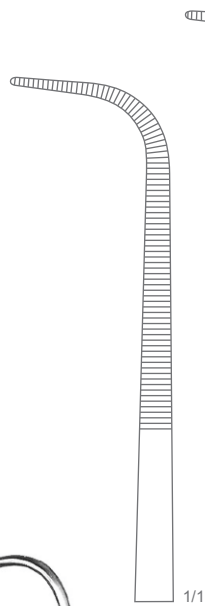

23-517-21
21 cm (8 1/4")

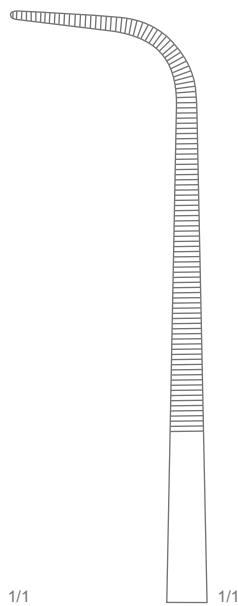

23-517-24
24.5 cm (9 3/4")



23-519-18
Lahey Dissecting and Ligature Forcep
Curved
Overall Length 18.5 cm (7 1/4")

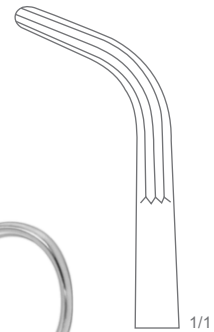

Operating Scissors
Chirurgische Scheren
Tijeras quirúrgicas
Ciseaux chirurgicaux
Forbici per chirurgia



23-523-20
20 cm (8")



23-523-25
25 cm (9 3/4")

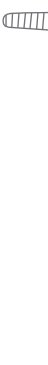

23-523-27
27.5 cm (10 3/4")

Kantrowitz Dissecting and Ligature Forcep
Right Angled



23-527-28
Extra Delicate
28 cm (11")



23-529-28
Delicate
28 cm (11")

Barre Dissecting and Ligature Forcep



Operating Scissors
Chirurgische Scheren
Tijeras quirúrgicas
Ciseaux chirurgicaux
Forbici per chirurgia



23-535-19
Lahey (Sweet) Bile Duct Clamp
Curved
Overall Length 19.5 cm (7 3/4")



23-537-23
Lahey Bile Duct Clamp
Angled
Overall Length 22.5 cm (8 3/4")

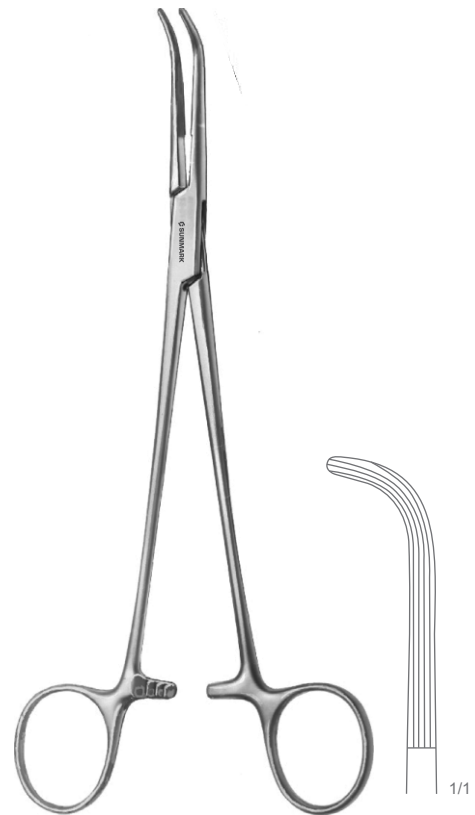

23-539-23
Lahey Bile Duct Clamp
Curved
Overall Length 23 cm (9")

Operating Scissors
Chirurgische Scheren
Tijeras quirúrgicas
Ciseaux chirurgicaux
Forbici per chirurgia

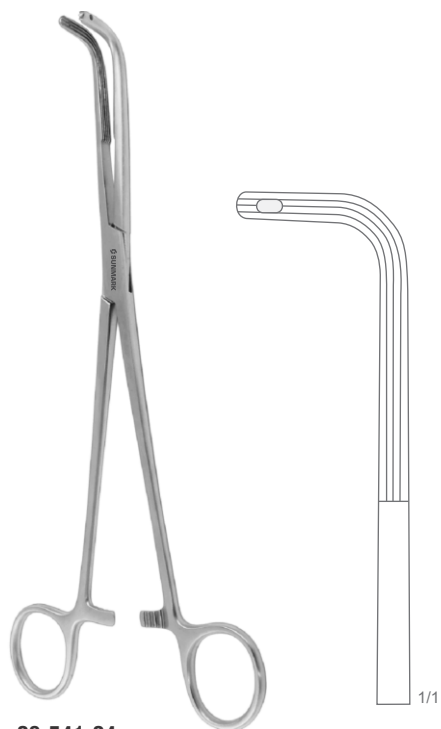

23-541-24
Finochietto Dissecting and Ligature Forcep
Right Angled
Overall Length 24 cm (9 1/2")

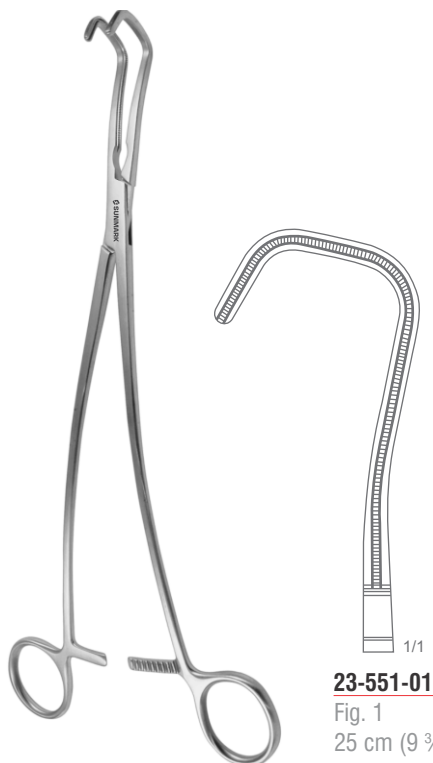

23-551-01
Fig. 1
25 cm (9 3/4")

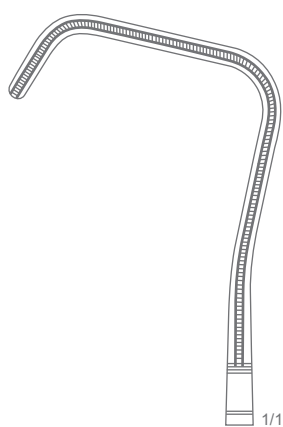

23-551-02
Fig. 2
27 cm (10 3/4")

URO Atrauma Tangential Occlusion Clamp

Operating Scissors
Chirurgische Scheren
Tijeras quirúrgicas
Ciseaux chirurgicaux
Forbici per chirurgia



Guyon Atrauma Kidney Pedicle Clamp
Curved

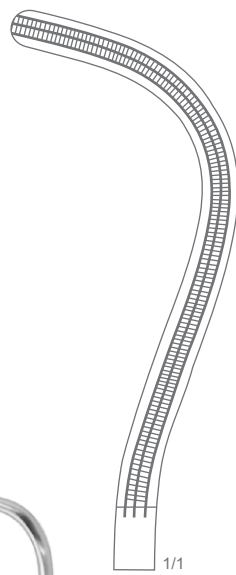

23-561-23
23 cm (9")

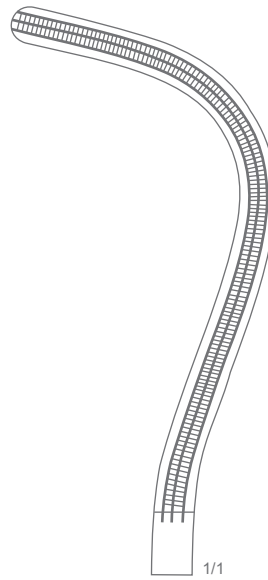

23-561-24
24 cm (9 1/2")

Operating Scissors
Chirurgische Scheren
Tijeras quirúrgicas
Ciseaux chirurgicaux
Forbici per chirurgia



23-563-23
Guyon Kidney Pedicle Clamp
Curved
Overall Length 24 cm (9 1/2")

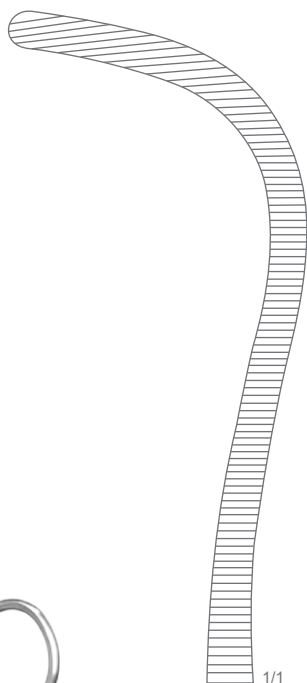

1/1



Guyon Kidney Pedicle Clamp
Curved

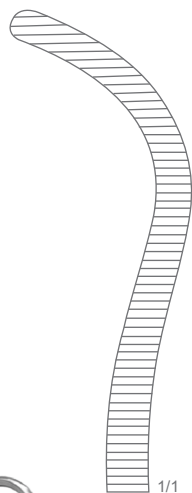

23-565-20
19.5 cm (7 3/4")

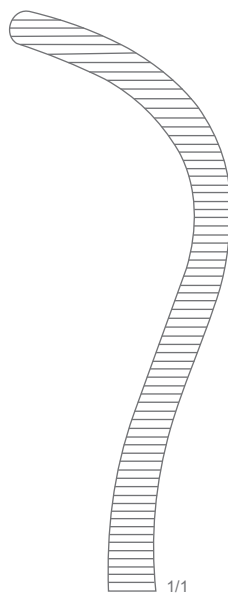

23-565-22
21.5 cm (8 1/2")

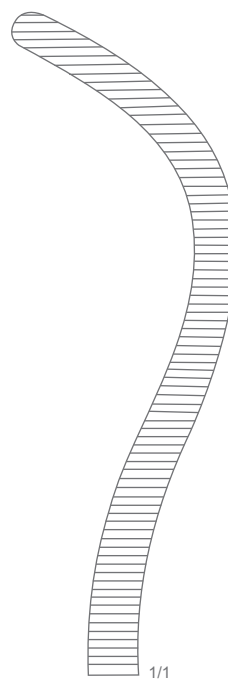

23-565-24
24 cm (9 1/2")

Operating Scissors
Chirurgische Scheren
Tijeras quirúrgicas
Ciseaux chirurgicaux
Forbici per chirurgia

23

THORAX, CARDIOVASCULAR SURGERY

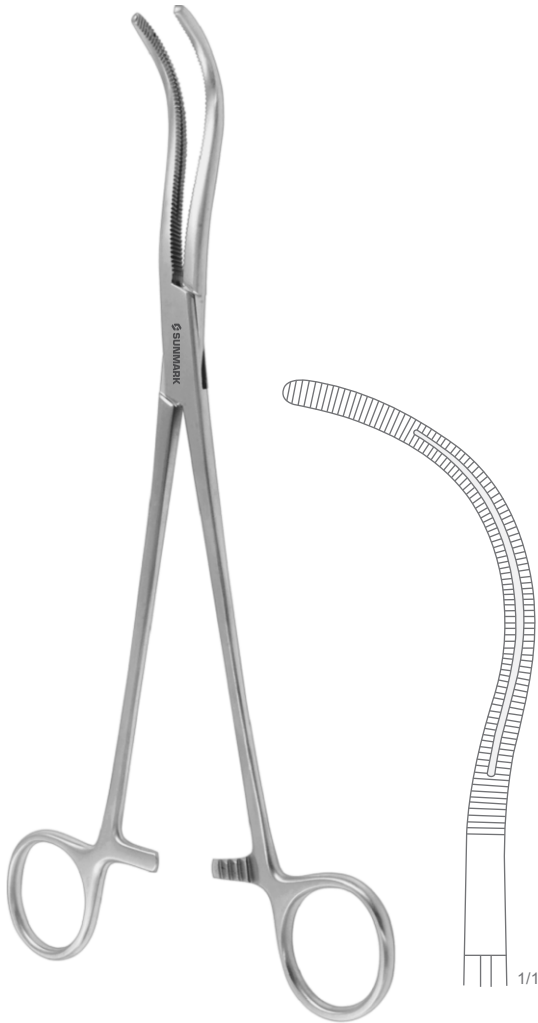

23-569-23
Stille Kidney Pedicle Clamp
Curved, Grooved
Overall Length 23 cm (9")



23-571-23
Herrick Kidney Pedicle Clamp
Double Angled, Longitudinally Serrated
Overall Length 23 cm (9")

Operating Scissors
Chirurgische Scheren
Tijeras quirúrgicas
Ciseaux chirurgicaux
Forbici per chirurgia

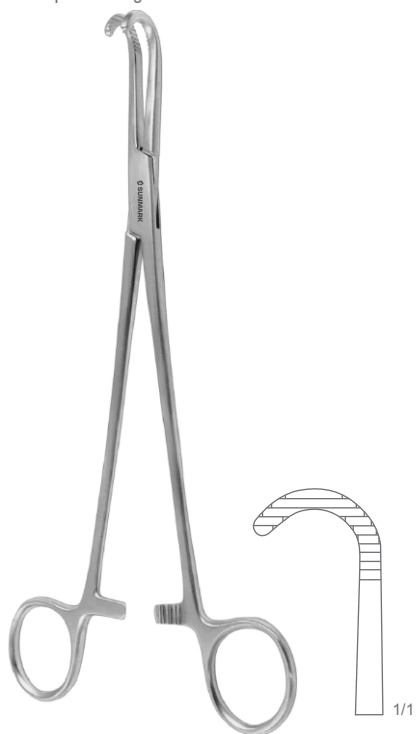

23-581-21
Desjardins Bile Duct Clamp
Curved Downwards
Overall Length 21 cm (8 1/4")

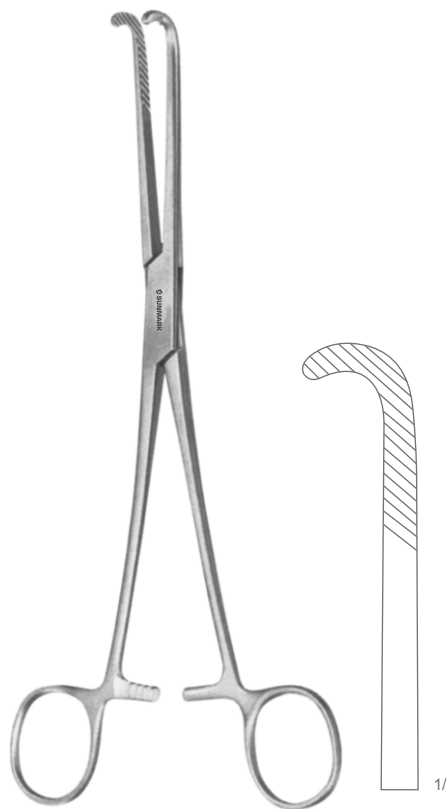

23-583-21
Nissen Bile Duct Clamp
Curved Downwards
Overall Length 21.5 cm (8 1/2")

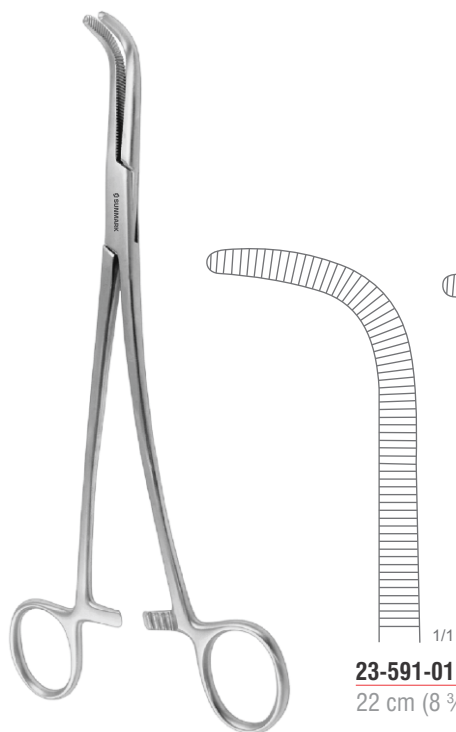

23-591-01
22 cm (8 3/4")

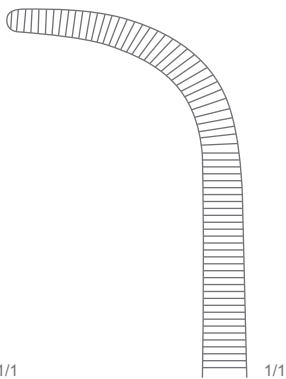

23-591-02
22 cm (8 3/4")

Gray Dissecting and Ligature Forcep
Curved S Shaped

Operating Scissors
 Chirurgische Scheren
 Tijeras quirúrgicas
 Ciseaux chirurgicaux
 Forbici per chirurgia

THORAX, CARDIOVASCULAR SURGERY

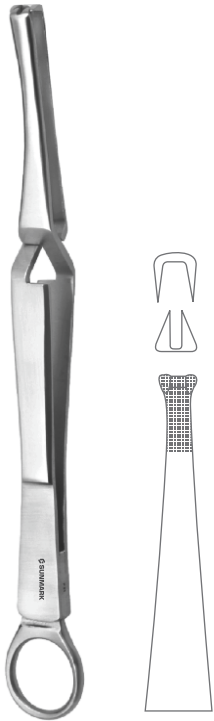

23-751-18
Doyen Towel Clamp
 Overall Length 18 cm (7")



23-755-09
Schaedel Towel Clamp
 Sharp
 Overall Length 9 cm (3 1/2")



23-761-05
 5.5 cm (2 1/2")
23-761-09
 8.5 cm (3 1/4")

Jones Towel Clamp
 Sharp



23-765-09
Martin-Jones Towel Clamp
 Sharp, With Cable Holder
 Overall Length 8.5 cm (3 1/4")



23-769-01
 For Cable Up To 5 mm
23-769-02
 For Cable Up To 13 mm

Robin Towel Clamp
 With Cable Holder
 Overall Length 13.5 cm (5 1/4")

Operating Scissors
Chirurgische Scheren
Tijeras quirúrgicas
Ciseaux chirurgicaux
Forbici per chirurgia

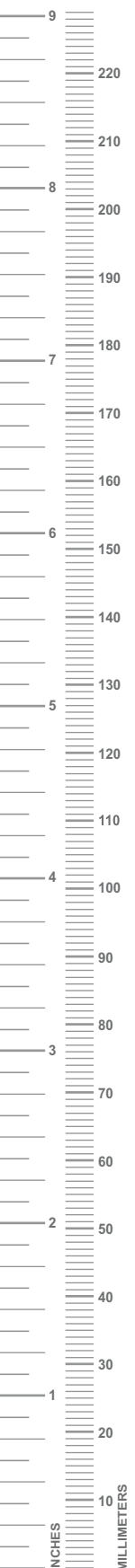

23-771-11
Backhaus Towel Clamp
With Tube Holder
Overall Length 13 cm (5")



Backhaus Towel Clamp

23-773-08
9 cm (3 1/2")

23-773-11
11.5 cm (4 1/2")

23-773-13
13 cm (5")

23-773-15
16 cm (6 1/4")



23-777-13
Reader Towel Clamp
Overall Length 13.5 cm (5 1/4")



Lorna Towel Clamp
Fine Serrated, Wide Jaw

23-781-10
9.5 cm (3 3/4")

23-781-13
13 cm (5")

Operating Scissors
Chirurgische Scheren
Tijeras quirúrgicas
Ciseaux chirurgicaux
Forbici per chirurgia

THORAX, CARDIOVASCULAR SURGERY



23-785-16
Bernhard Towel Clamp
Overall Length 16.5 cm (6 1/2")



Tohoku Towel Clamp
Blunt



23-787-10
10.5 cm (4")

23-787-13
13.5 cm (5 1/4")



Non Perforating Towel Clamp

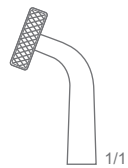

23-791-10
10 cm (4")

23-791-13
13.5 cm (5 1/4")

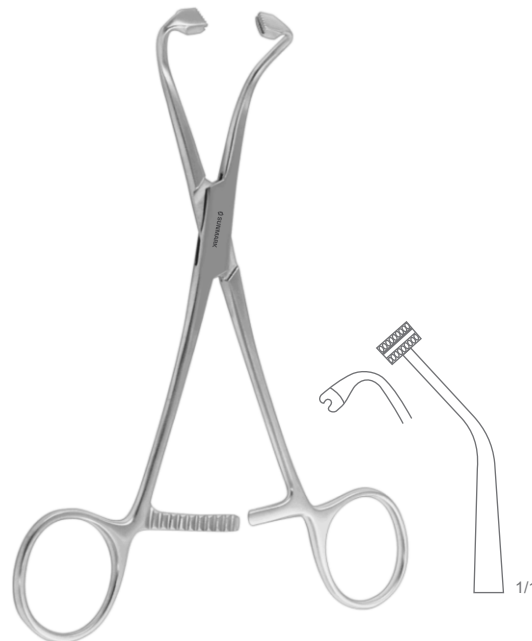

23-793-14
Peers-Bertram Towel Clamp
With Jaw for Tube Fixation
Overall Length 16.5 cm (6 1/2")

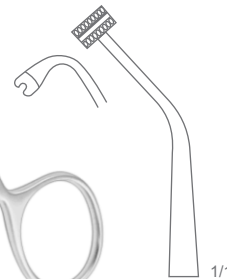

Operating Scissors
Chirurgische Scheren
Tijeras quirúrgicas
Ciseaux chirurgicaux
Forbici per chirurgia



Towel Clamp
For Paper Clothes

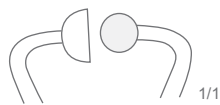

23-795-11
11.5 cm (4 1/2")

23-795-14
14 cm (5 1/2")



Lane Towel Clamp



23-799-13
13 cm (5")

23-799-15
15.5 cm (6")

23-799-20
19.5 cm (7 3/4")



23-751-18
Moynihan Towel Forcep
2 x 2 Teeth
Overall Length 19 cm (7 1/2")



23-850-14
Klinikum Berlin Tubing Clamp
Extra Long Ratchet
Overall Length 14 cm (5 1/2")



Presbyterian Tubing Clamp

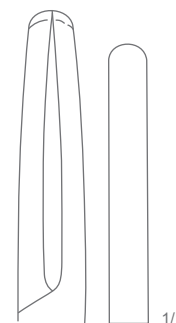

23-852-16
16.5 cm (6 1/2")

23-852-18
18 cm (7")

Operating Scissors
Chirurgische Scheren
Tijeras quirúrgicas
Ciseaux chirurgicaux
Forbici per chirurgia

THORAX, CARDIOVASCULAR SURGERY



Tubing Clamp



23-860-15
15.5 cm (6")

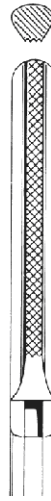

23-860-18
19 cm (7 1/2")



23-860-20
20.5 cm (8")



**Tubing Clamp
With Safety Guard**



23-862-15
15.5 cm (6")



23-862-18
19 cm (7 1/2")



23-862-20
20.5 cm (8")

Operating Scissors
Chirurgische Scheren
Tijeras quirúrgicas
Ciseaux chirurgicaux
Forbici per chirurgia



23-890-00
Brompton Tube Milking Roller
Standard



Operating Scissors
Chirurgische Scheren
Tijeras quirúrgicas
Ciseaux chirurgicaux
Forbici per chirurgia



67-104-21
Loute Wire Tightener
Overall Length 21 cm (8 1/4")



67-106-27
Demel Wire Tightener and Twister
Overall Length 27 cm (10 3/4")

Operating Scissors
Chirurgische Scheren
Tijeras quirúrgicas
Ciseaux chirurgicaux
Forbici per chirurgia



UltraGrip™ TC Wire Twisting Forcep

ULTRA GRIP[™]



1/1

67-170-15
15.5 cm (6")

67-170-18
18 cm (7")



1/1

67-172-15
15.5 cm (6")

67-172-18
18 cm (7")



1/1

67-174-15
15.5 cm (6")

67-174-18
18 cm (7")

Operating Scissors
Chirurgische Scheren
Tijeras quirúrgicas
Ciseaux chirurgicaux
Forbici per chirurgia

THORAX, CARDIOVASCULAR SURGERY



67-176-20
UltraGrip™ TC Baumgartner Wire Twisting Forcep
Overall Length 20 cm (8")

ULTRA GRIP[™]



67-177-15
UltraGrip™ TC Wire Twisting Forcep
Overall Length 14.5 cm (5 ¾")

ULTRA GRIP[™]

Operating Scissors
Chirurgische Scheren
Tijeras quirúrgicas
Ciseaux chirurgicaux
Forbici per chirurgia



67-180-16
UltraGrip™ TC Corwin Wire Twisting Forcep
Overall Length 16 cm (6 1/4")

ULTRA GRIP X™



67-182-18
UltraGrip™ TC Combi Wire Twisting Forcep
Overall Length 18.5 cm (7 1/4")

ULTRA GRIP X™

Operating Scissors
Chirurgische Scheren
Tijeras quirúrgicas
Ciseaux chirurgicaux
Forbici per chirurgia

THORAX, CARDIOVASCULAR SURGERY



67-184-19
UltraGrip™ TC Berry Wire Twisting Forcep
Heavy Pattern, With Tungsten Carbide Inserts
Overall Length 19 cm (7 ½")

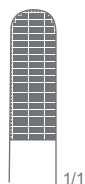

UltraGrip™ Combi-Flat Nose Plier
Parallel Grip, Compound Action

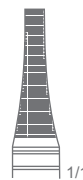

67-186-01

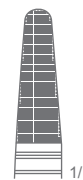

67-186-02

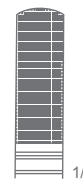

67-186-03



Operating Scissors
Chirurgische Scheren
Tijeras quirúrgicas
Ciseaux chirurgicaux
Forbici per chirurgia



67-190-14
Flat Nose Plier
Overall Length 13.5 cm (5 1/4")

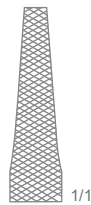

1/1



67-192-14
Flat Nose Plier
Overall Length 14 cm (5 1/4")

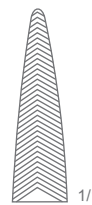

1/1



67-194-14
Flat Nose Plier
Overall Length 14 cm (5 1/4")

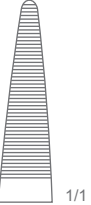

1/1



Flat Nose Plier

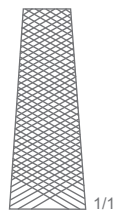

67-196-17
17.5 cm (7")

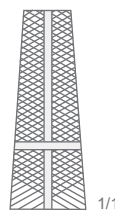

67-198-17
With Crosswise Groove
17 cm (6 3/4")

Operating Scissors
Chirurgische Scheren
Tijeras quirúrgicas
Ciseaux chirurgicaux
Forbici per chirurgia



67-200-19
Flat Nose Plier
Pointed
Overall Length 19.5 cm (7 3/4")



67-202-16
Flat Nose Plier
With Longitudinal Groove
Overall Length 16 cm (6 1/4")



67-204-15
Combi-Flat Nose Plier
For Bending and Cutting
Overall Length 15 cm (6")



67-210-17
Flat Nose Plier
Parallel Grip
Overall Length 18.5 cm (7 1/4")

THORAX, CARDIOVASCULAR SURGERY

Operating Scissors
Chirurgische Scheren
Tijeras quirúrgicas
Ciseaux chirurgicaux
Forbici per chirurgia

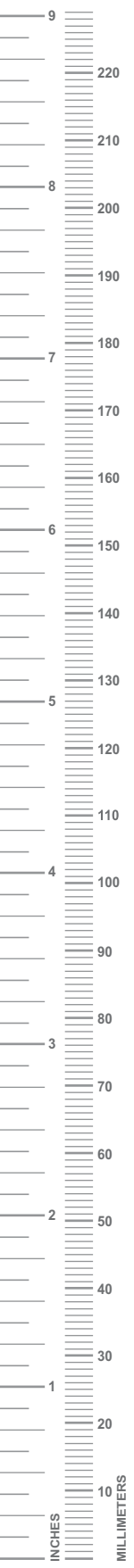

67-212-18
Vise Grip Plier
Overall Length 20.5 cm (8")

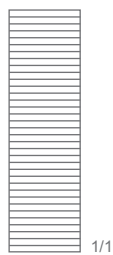

Combi-Flat Nose Plier
Parallel Grip, Compound Action
Overall Length 18 cm (7")

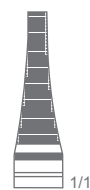

67-214-01

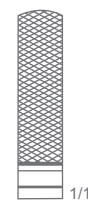

67-214-02

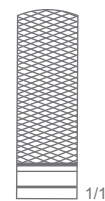

67-214-03

Operating Scissors
Chirurgische Scheren
Tijeras quirúrgicas
Ciseaux chirurgicaux
Forbici per chirurgia

THORAX, CARDIOVASCULAR SURGERY



67-214-04
Flat Nose Plier
Overall Length 18 cm (7")



67-220-18
Wire Cutting Plier
For Soft Wires Up to Ø 2.4 mm
For Hard Wires Up to Ø 1.8 mm
Overall Length 18.5 cm (7 ¼")



67-222-16
Wire Cutting Plier
For Soft Wires Up to Ø 2.2 mm
For Hard Wires Up to Ø 2.0 mm
Overall Length 16 cm (6 ¼")

Operating Scissors
Chirurgische Scheren
Tijeras quirúrgicas
Ciseaux chirurgicaux
Forbici per chirurgia

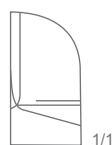

67-230-13
UltraCut™ TC Wire Cutting Plier
For Soft Wires Up to Ø 1.5 mm
For Hard Wires Up to Ø 1.0 mm
Overall Length 13 cm (5 ¼")

ULTRA.Cut™



67-232-16
UltraCut™ TC Wire Cutting Plier
For Soft Wires Up to Ø 3.5 mm
For Hard Wires Up to Ø 2.5 mm
Overall Length 16.5 cm (6 ½")

ULTRA.Cut™

Operating Scissors
Chirurgische Scheren
Tijeras quirúrgicas
Ciseaux chirurgicaux
Forbici per chirurgia



UltraCut™ TC Wire Cutting Plier

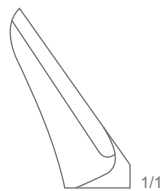

67-234-18

For Soft Wires Up to Ø 2.5 mm
For Hard Wires Up to Ø 1.7 mm
17.5 cm (7")

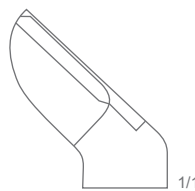

67-234-22

For Soft Wires Up to Ø 2.5 mm
For Hard Wires Up to Ø 1.7 mm
22.5 cm (8 ¾")

ULTRA *Cut*™



67-236-22

UltraCut™ TC Wire Cutting Plier

For Soft Wires Up to Ø 3.0 mm, For Hard Wires Up to Ø 2.2 mm
Overall Length 23 cm (9")

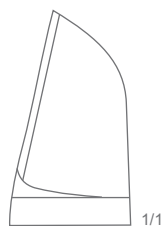

ULTRA *Cut*™

THORAX, CARDIOVASCULAR SURGERY

Operating Scissors
Chirurgische Scheren
Tijeras quirúrgicas
Ciseaux chirurgicaux
Forbici per chirurgia



67-238-15
UltraCut™ TC Wire Cutting Plier
For Soft Wires Up to Ø 2.0 mm
For Hard Wires Up to Ø 1.7 mm
Overall Length 15 cm (6")



67-238-22
UltraCut™ TC Wire Cutting Plier
For Soft Wires Up to Ø 3.0 mm
For Hard Wires Up to Ø 2.0 mm
Overall Length 22 cm (8 ¾")

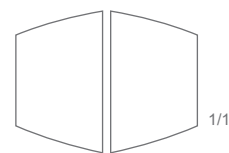

Operating Scissors
Chirurgische Scheren
Tijeras quirúrgicas
Ciseaux chirurgicaux
Forbici per chirurgia

THORAX, CARDIOVASCULAR SURGERY



67-421-30
Putti Bone Rasp
Curved, Straight
Overall Length 30 cm (11 3/4")



67-423-27
Putti Bone Rasp
Curved, Round
Overall Length 27 cm (10 3/4")

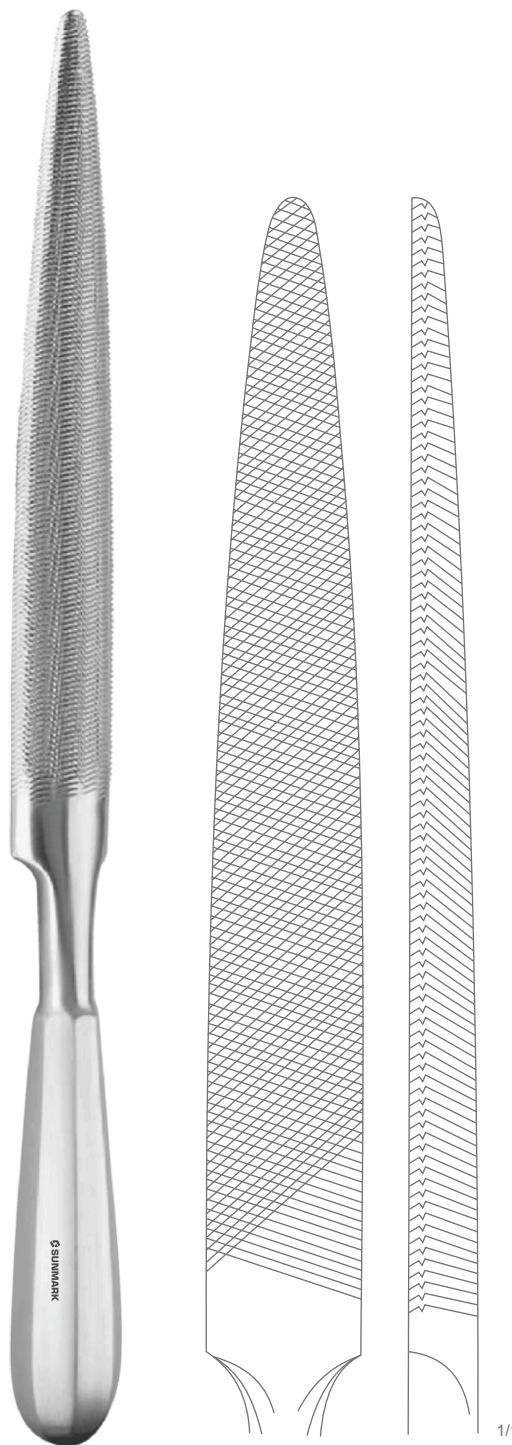

67-426-28
Bone File
Semi Round
Overall Length 28 cm (11")

Operating Scissors
Chirurgische Scheren
Tijeras quirúrgicas
Ciseaux chirurgicaux
Forbici per chirurgia

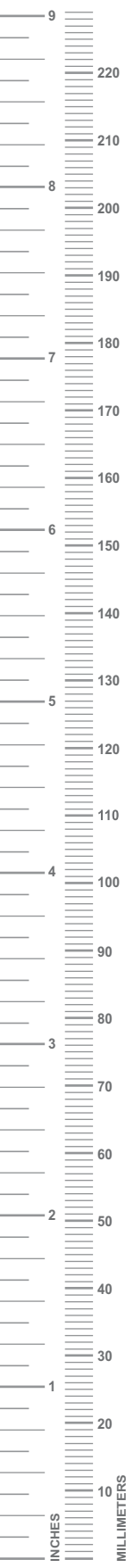

67-427-24
Bone File
Semi Round
Overall Length 24.5 cm (9 3/4")



67-430-22
Bone File
Flat
Overall Length 22 cm (8 3/4")

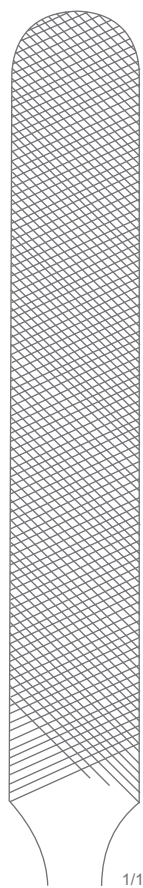

Operating Scissors
 Chirurgische Scheren
 Tijeras quirúrgicas
 Ciseaux chirurgicaux
 Forbici per chirurgia

THORAX, CARDIOVASCULAR SURGERY



67-526-40
 Fig. 0000
 2.8 mm



67-526-30
 Fig. 000
 3.6 mm



67-526-20
 Fig. 00
 4.4 mm



67-526-10
 Fig. 0
 5.2 mm



67-526-01
 Fig. 1
 6.8 mm

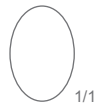

67-526-02
 Fig. 2
 8.5 mm

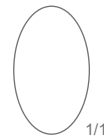

67-526-03
 Fig. 3
 10 mm

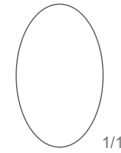

67-526-04
 Fig. 4
 11.5 mm

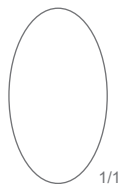

67-526-05
 Fig. 5
 13 mm

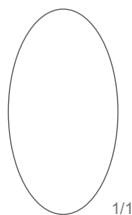

67-526-06
 Fig. 6
 14.5 mm

Volkman Bone Curette
 Oval
 Overall Length 17 cm (6 3/4")

Operating Scissors
 Chirurgische Scheren
 Tijeras quirúrgicas
 Ciseaux chirurgicaux
 Forbici per chirurgia



6.1 mm

67-552-13
 12.5 cm (5")

7.2 mm

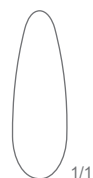

1/1



6.2 mm

67-552-14
 14.5 cm (5 3/4")

6.8 mm



1/1



6.2 mm

67-552-17
 17 cm (6 3/4")

7.5 mm



1/1

Volkman Bone Curette
 Double Ended, Oval/Oval



Ø 6.5 mm

67-554-13
 13 cm (5")

6.0 mm



1/1



Ø 9.0 mm

67-554-16
 16 cm (6 1/4")

7.0 mm



1/1



Ø 11.0 mm

67-554-20
 20 cm (8")

9.0 mm



1/1

Volkman Bone Curette
 Double Ended, Round/Oval

Operating Scissors
Chirurgische Scheren
Tijeras quirúrgicas
Ciseaux chirurgicaux
Forbici per chirurgia

67

THORAX, CARDIOVASCULAR SURGERY

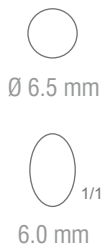

67-556-21
Bone Curette
Double Ended, Round/Oval
Overall Length 21 cm (8 ¼")

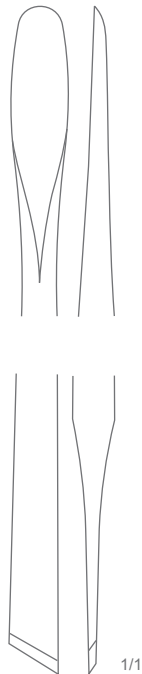

67-602-16
Mead Periosteal Raspatory/Elevator
Overall Length 16.5 cm (6 ½")

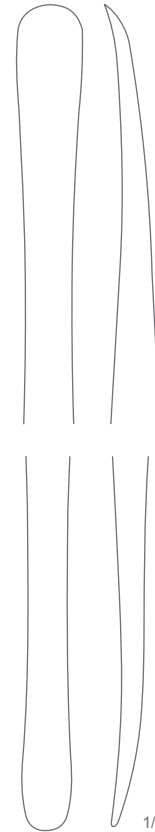

67-603-18
Molt Periosteal Raspatory/Elevator
Overall Length 18 cm (7")

Operating Scissors
Chirurgische Scheren
Tijeras quirúrgicas
Ciseaux chirurgicaux
Forbici per chirurgia

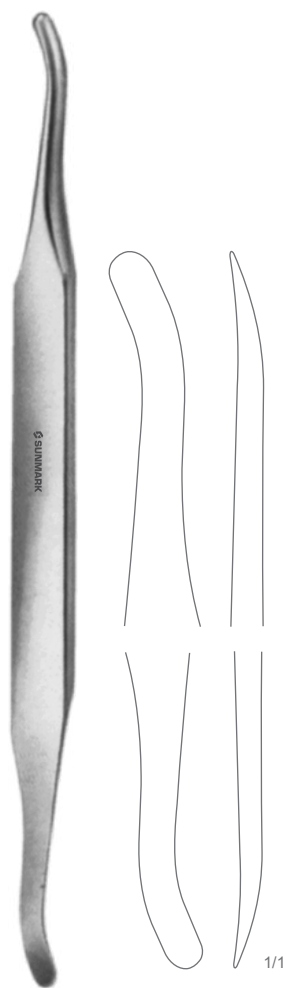

67-609-19
Seldin Periosteal Raspatory/Elevator
Overall Length 19.5 cm (7 3/4")

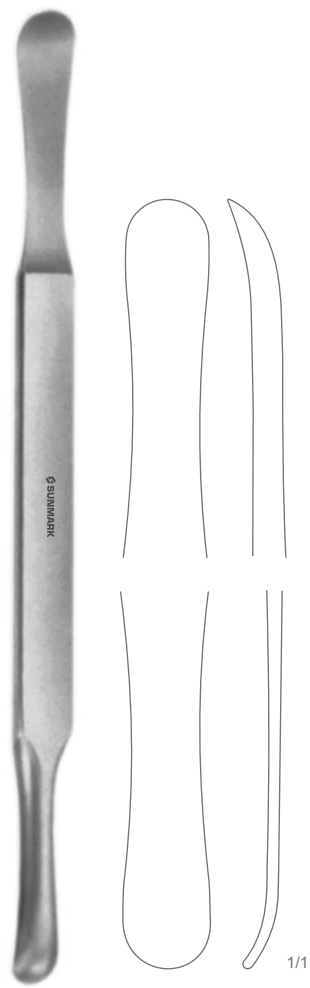

67-611-19
Seldin Periosteal Raspatory/Elevator
Overall Length 19.5 cm (7 3/4")

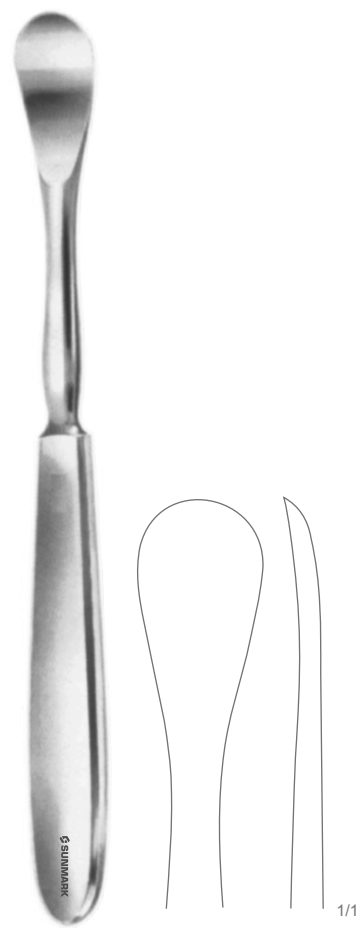

67-619-18
Sedillot Periosteal Raspatory / Elevator
18 mm
Overall Length 18.5 cm (7 1/4")

Operating Scissors
 Chirurgische Scheren
 Tijeras quirúrgicas
 Ciseaux chirurgicaux
 Forbici per chirurgia



67-633-09
McGlamry Periosteal Raspatory/Elevator
 9 mm
 Overall Length 17 cm (6 3/4")



Langenbeck Periosteal Raspatory / Elevator



67-635-01 16 mm 19 cm (7 1/2")
67-635-02 16 mm 19 cm (7 1/2")

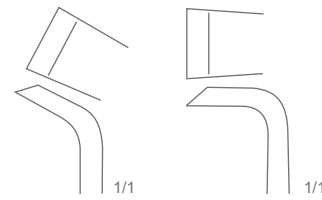

67-635-03 12 mm 18.5 cm (7 1/4")
67-635-04 12 mm 18 cm (7")

THORAX, CARDIOVASCULAR SURGERY

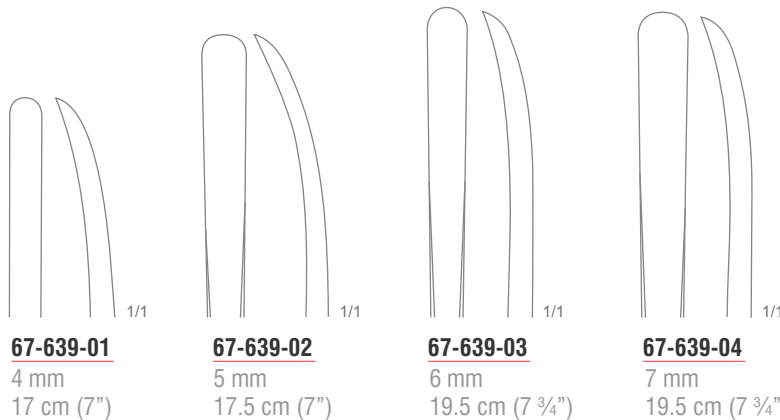

67-639-01 4 mm 17 cm (7")
67-639-02 5 mm 17.5 cm (7")
67-639-03 6 mm 19.5 cm (7 3/4")
67-639-04 7 mm 19.5 cm (7 3/4")

Cushing Periosteal Raspatory / Elevator

Operating Scissors
Chirurgische Scheren
Tijeras quirúrgicas
Ciseaux chirurgicaux
Forbici per chirurgia

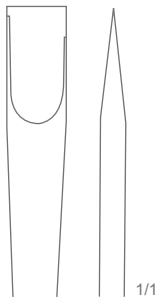

67-640-17
Martin-Cushing Periosteal Raspatory/Elevator
8 mm
Overall Length 17 cm (6 3/4")

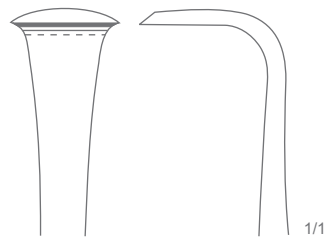

67-641-18
Martin-Cushing Periosteal Raspatory/Elevator
14 mm
Overall Length 18 cm (7")

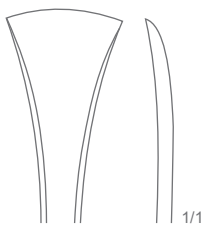

67-643-19
Martin-Cushing Periosteal Raspatory/Elevator
16 mm
Overall Length 19.5 cm (7 3/4")

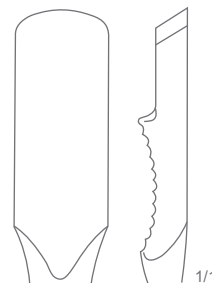

67-648-15
15 cm (6")

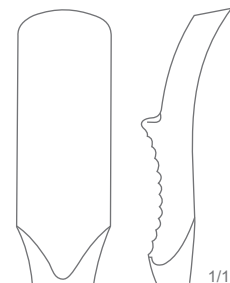

67-649-15
15 cm (6")

Farabeuf Periosteal Raspatory / Elevator
12.5 mm

Operating Scissors
Chirurgische Scheren
Tijeras quirúrgicas
Ciseaux chirurgicaux
Forbici per chirurgia

67

THORAX, CARDIOVASCULAR SURGERY

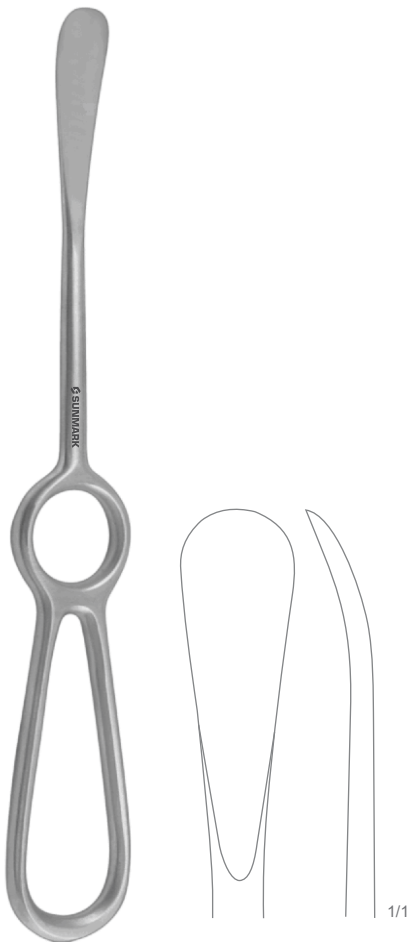

67-651-21
Sedillot Periosteal Raspatory/Elevator
15 mm
Overall Length 22 cm (8 3/4")

Operating Scissors
Chirurgische Scheren
Tijeras quirúrgicas
Ciseaux chirurgicaux
Forbici per chirurgia

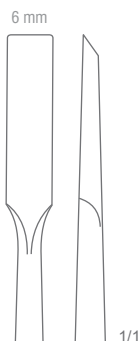

67-654-19
FiberGrip™ Periosteal Raspator/Elevator
6 mm
Overall Length 19 cm (7 1/2")

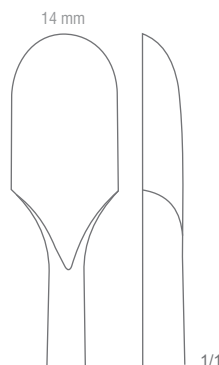

67-655-20
FiberGrip™ Periosteal Raspator/Elevator
14 mm
Overall Length 20 cm (8")

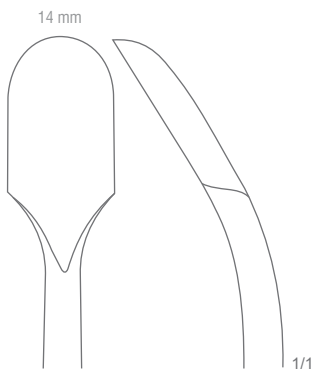

67-657-20
FiberGrip™ Periosteal Raspator/Elevator
14 mm
Overall Length 19 cm (7 1/2")



67-659-18
FiberGrip™ Periosteal Raspator/Elevator
6 mm
Overall Length 18 cm (7")

Operating Scissors
 Chirurgische Scheren
 Tijeras quirúrgicas
 Ciseaux chirurgicaux
 Forbici per chirurgia

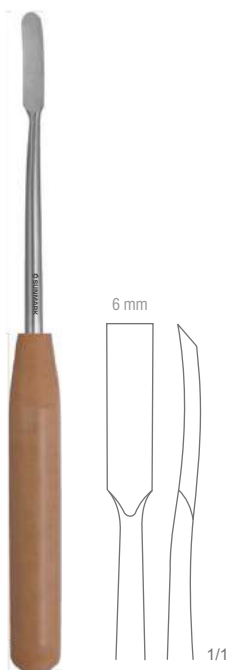

67-661-18
 FiberGrip™ Periosteal Raspatory/Elevator
 6 mm
 Overall Length 18 cm (7")

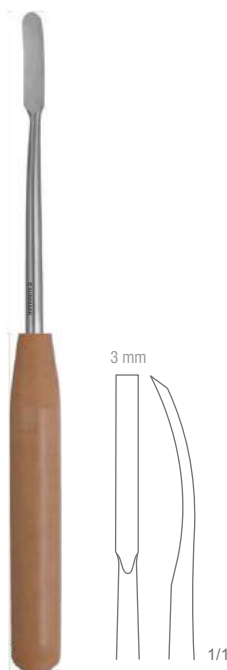

67-663-18
 FiberGrip™ Periosteal Raspatory/Elevator
 3 mm
 Overall Length 18 cm (7")

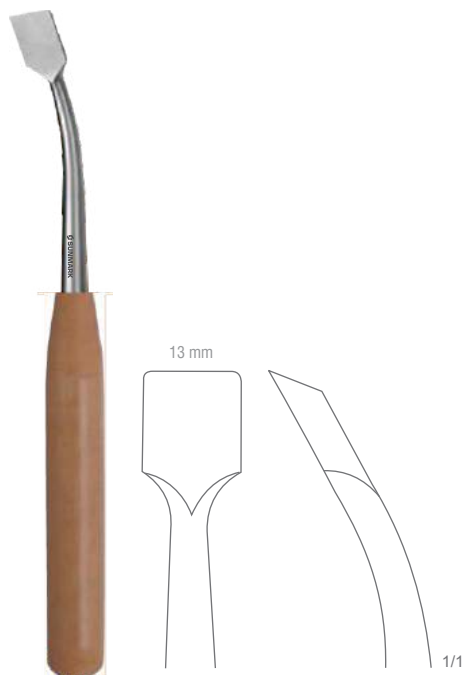

67-665-17
 FiberGrip™ Periosteal Raspatory/Elevator
 13 mm
 Overall Length 18.5 cm (7")

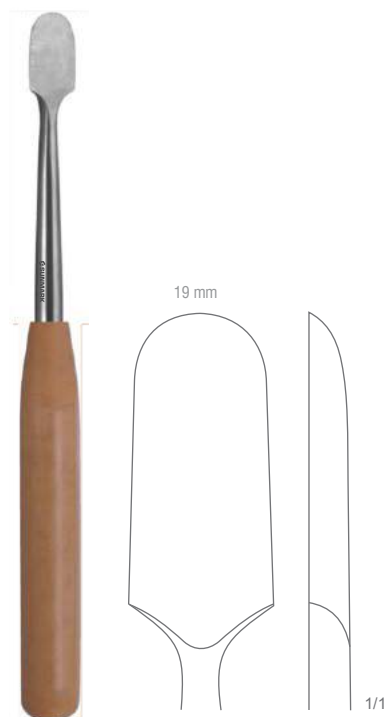

67-666-20
 FiberGrip™ Periosteal Raspatory/Elevator
 19 mm
 Overall Length 20 cm (8")



Operating Scissors
Chirurgische Scheren
Tijeras quirúrgicas
Ciseaux chirurgicaux
Forbici per chirurgia

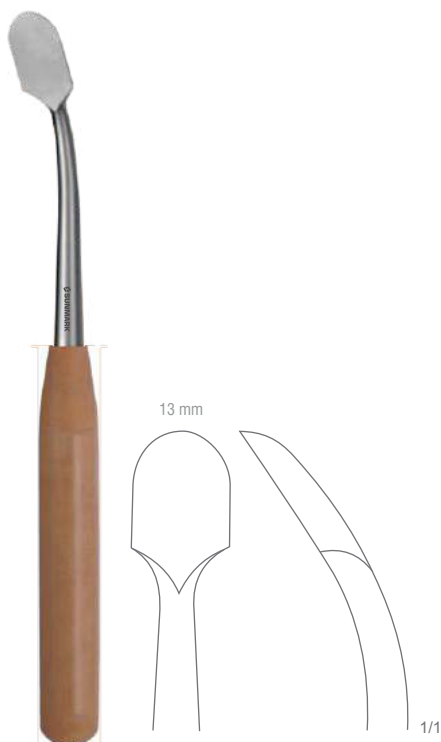

67-667-18
FiberGrip™ Periosteal Raspatory/Elevator
13 mm
Overall Length 18 cm (7")



67-669-27
FiberGrip™ Periosteal Raspatory/Elevator
20 mm
Overall Length 27 cm (10 3/4")



Operating Scissors
Chirurgische Scheren
Tijeras quirúrgicas
Ciseaux chirurgicaux
Forbici per chirurgia



FiberGrip™ Wagner Periosteal Raspatory/Elevator
Overall Length 33 cm (13")



Operating Scissors
 Chirurgische Scheren
 Tijeras quirúrgicas
 Ciseaux chirurgicaux
 Forbici per chirurgia



67-673-13
Williger Periosteal Raspatory / Elevator
 5 mm
 Overall Length 12.5 cm (5")



67-677-01
 7 mm



67-677-02
 5 mm

Williger Periosteal Raspatory / Elevator
 Overall Length 16 cm (6 1/4")

Operating Scissors
Chirurgische Scheren
Tijeras quirúrgicas
Ciseaux chirurgicaux
Forbici per chirurgia

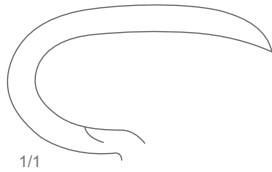

67-680-01
For Adults
Curved Right



67-680-02
For Adults
Curved Left



67-681-01
For Children
Curved Right



67-681-02
For Children
Curved Left

Doyen Rib Raspatory
Overall Length 17.5 cm (7")

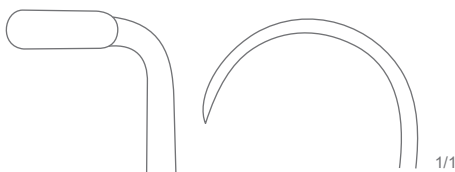

67-681-03
5 mm
Curved Left

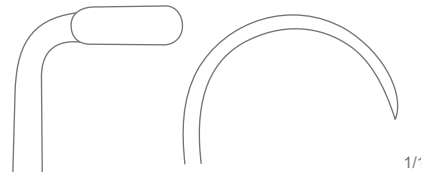

67-681-04
5 mm
Curved Right

Daniel Rib Raspatory
Overall Length 17.5 cm (7")

Operating Scissors
Chirurgische Scheren
Tijeras quirúrgicas
Ciseaux chirurgicaux
Forbici per chirurgia



67-682-01
Overholt Periosteal Elevator
Fig. 1
Overall Length 29 cm (11 1/2")



67-682-02
Overholt Periosteal Elevator
Fig. 2
Overall Length 27 cm (10 1/4")



67-682-21
Alexander Periosteal Raspatory/Elevator
Overall Length 21 cm (8 1/4")



67-682-22
Matson Rib Elevator and Spreader
Overall Length 22.5 cm (8 3/4")

Operating Scissors
 Chirurgische Scheren
 Tijeras quirúrgicas
 Ciseaux chirurgicaux
 Forbici per chirurgia

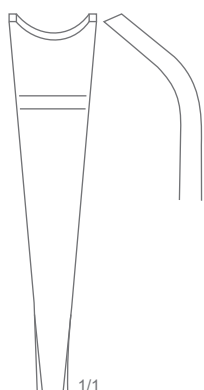

67-683-01
 Fig. 1
 12 mm

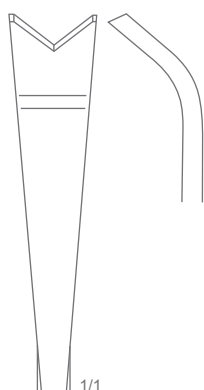

67-683-02
 Fig. 2
 12 mm

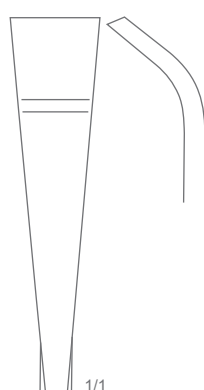

67-683-03
 Fig. 3
 13 mm

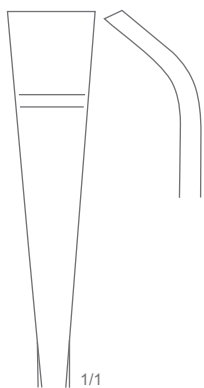

67-683-04
 Fig. 4
 13 mm



67-683-05
 Fig. 5
 15 mm

Semb Periosteal Raspatory/Elevator
 Overall Length 18.5 cm (7 1/4")

Operating Scissors
Chirurgische Scheren
Tijeras quirúrgicas
Ciseaux chirurgicaux
Forbici per chirurgia

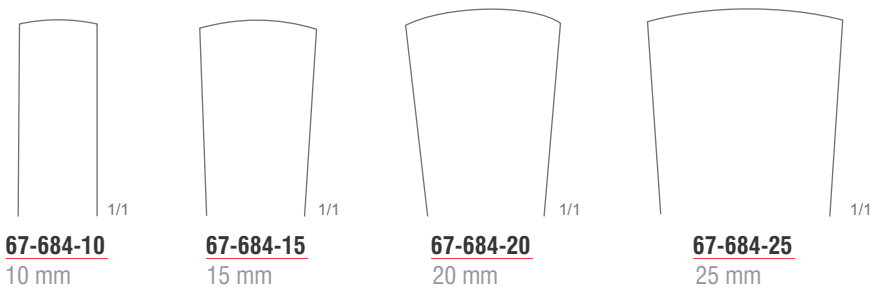

Lambotte Periosteal Raspatory/Elevator
Overall Length 21.5 cm (8 1/2")

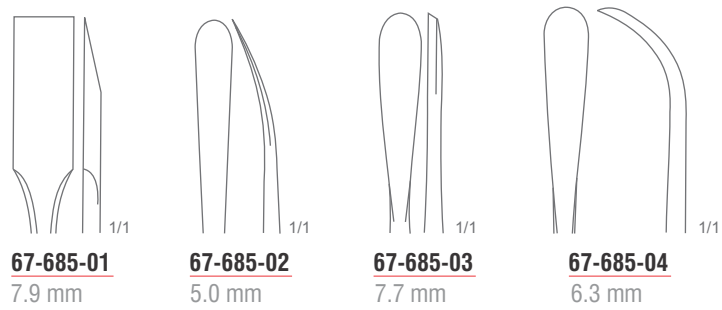

Adson Periosteal Raspatory/Elevator
Overall Length 17 cm (6 3/4")

Operating Scissors
Chirurgische Scheren
Tijeras quirúrgicas
Ciseaux chirurgicaux
Forbici per chirurgia

THORAX, CARDIOVASCULAR SURGERY



67-937-16
Mead Bone Rongeur
Overall Length 16.5 cm (6 1/2")



67-937-18
Hartmann Bone Rongeur
Overall Length 17.5 cm (7")

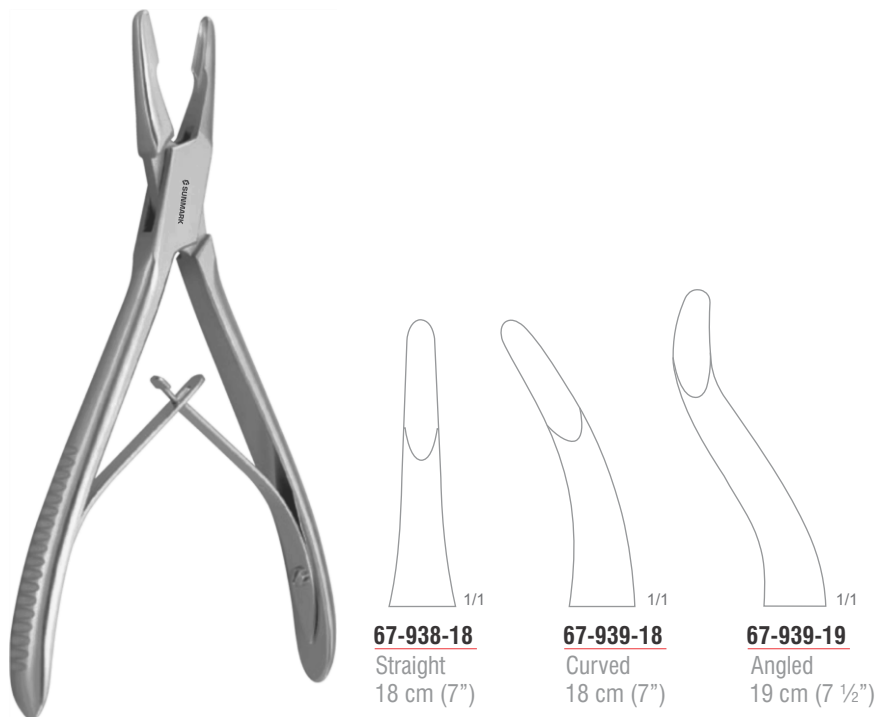

67-938-18
Straight
18 cm (7")

67-939-18
Curved
18 cm (7")

67-939-19
Angled
19 cm (7 1/2")

Jansen Bone Rongeur

Operating Scissors
Chirurgische Scheren
Tijeras quirúrgicas
Ciseaux chirurgicaux
Forbici per chirurgia

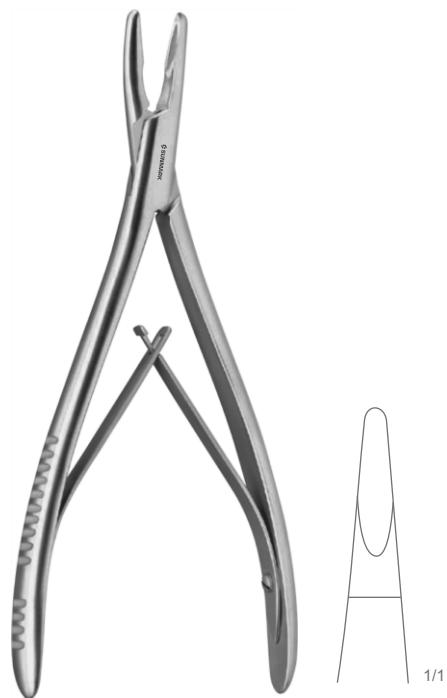

67-940-19
Lempert Bone Rongeur
Overall Length 19 cm (7 1/2")



67-946-15
Straight

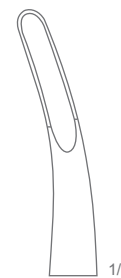

67-947-15
Curved

Bohler Bone Rongeur
Compound Action
Overall Length 15.5 cm (6")



67-949-18
Beyer Bone Rongeur
Compound Action
Overall Length 18 cm (7")



67-951-18
Zaufal-Jansen Bone Rongeur
Compound Action
Overall Length 18 cm (7")

Operating Scissors
Chirurgische Scheren
Tijeras quirúrgicas
Ciseaux chirurgicaux
Forbici per chirurgia

THORAX, CARDIOVASCULAR SURGERY



67-953-17
Mayfield Bone Rongeur
Compound Action
Overall Length 18 cm (7")



67-953-20
Marquard Bone Rongeur
Compound Action
Overall Length 20.5 cm (8")



67-955-18
Ruskin Bone Rongeur
Compound Action
Overall Length 19 cm (7 1/2")



67-955-24
Ruskin Bone Rongeur
Compound Action
Overall Length 24 cm (9 1/2")

Operating Scissors
Chirurgische Scheren
Tijeras quirúrgicas
Ciseaux chirurgicaux
Forbici per chirurgia



67-957-22
Semb Bone Rongeur
Compound Action
Overall Length 23.5 cm (9 1/4")



67-959-23
Stille-Ruskin Bone Rongeur
Compound Action
Overall Length 23.5 cm (9 1/4")



67-959-24
Roettgen-Ruskin Bone Rongeur
Compound Action
Overall Length 24.5 cm (9 3/4")



Stille-Luer Bone Rongeur
Compound Action
Overall Length 22.5 cm (8 3/4")

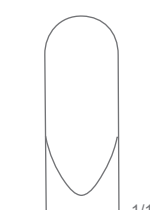

67-964-22
Straight

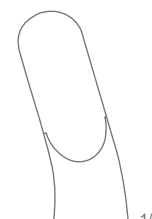

67-965-22
Curved

Operating Scissors
Chirurgische Scheren
Tijeras quirúrgicas
Ciseaux chirurgicaux
Forbici per chirurgia

THORAX, CARDIOVASCULAR SURGERY

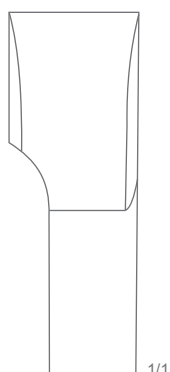

67-968-01

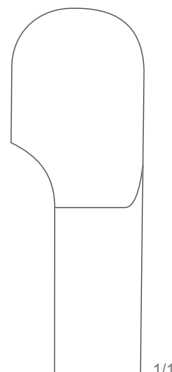

67-968-02

Sauerbruch Bone Rongeur
Compound Action
Overall Length 31 cm (12 1/4")

Operating Scissors
 Chirurgische Scheren
 Tijeras quirúrgicas
 Ciseaux chirurgicaux
 Forbici per chirurgia



67-970-19
Cottle-Kazanjan Bone Cutting Forcep
 Overall Length 18.5 cm (7 1/4")



Liston Bone Cutting Forcep



67-972-14
 Straight
 14 cm (5 1/2")



67-972-17
 Straight
 17 cm (6 3/4")

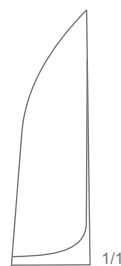

67-972-19
 Straight
 20 cm (8")

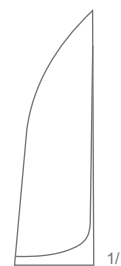

67-972-22
 Straight
 22 cm (8 3/4")



67-973-14
 Straight
 14 cm (5 1/2")



67-973-17
 Straight
 17 cm (6 3/4")

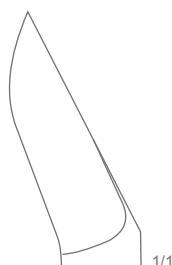

67-973-19
 Straight
 20 cm (8")

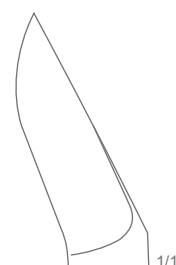

67-973-22
 Straight
 22 cm (8 3/4")

Operating Scissors
 Chirurgische Scheren
 Tijeras quirúrgicas
 Ciseaux chirurgicaux
 Forbici per chirurgia

THORAX, CARDIOVASCULAR SURGERY

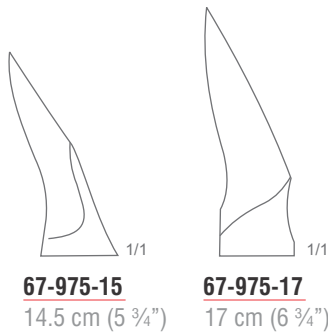

Cleveland Bone Cutting Forcep

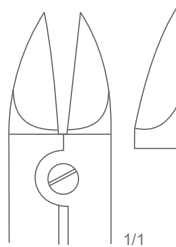

67-976-15
Bohler Bone Cutting Forcep
 Compound Action, Light
 Overall Length 14.5 cm (5 3/4")

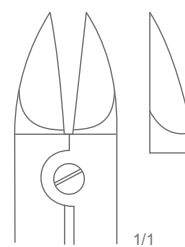

67-977-15
Bohler Bone Cutting Forcep
 Compound Action, Heavy
 Overall Length 14.5 cm (5 3/4")

Operating Scissors
Chirurgische Scheren
Tijeras quirúrgicas
Ciseaux chirurgicaux
Forbici per chirurgia

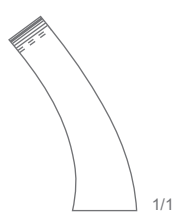
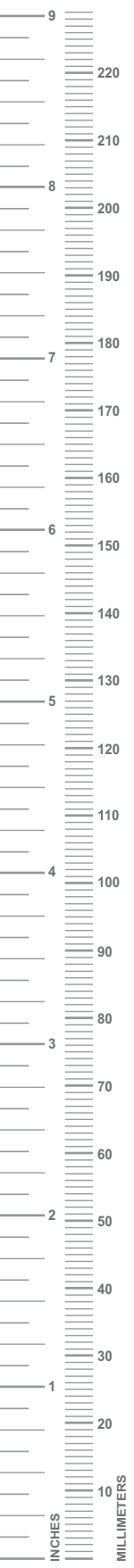

67-979-15
Cleveland Bone Cutting Forcep
Overall Length 16 cm (6 1/4")

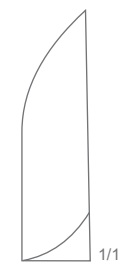

67-980-18
Straight

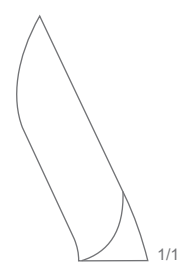

67-981-18
Curved

Ruskin-Liston Bone Cutting Forcep
Compound Action
Overall Length 18 cm (7")

Operating Scissors
Chirurgische Scheren
Tijeras quirúrgicas
Ciseaux chirurgicaux
Forbici per chirurgia

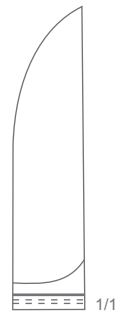

67-982-01
Straight
27.5 cm (10 3/4")

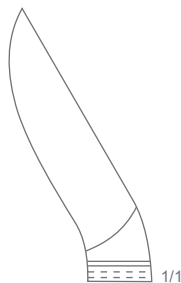

67-982-02
Curved
23.5 cm (9 1/4")



67-982-03
Curved
27.5 cm (10 3/4")

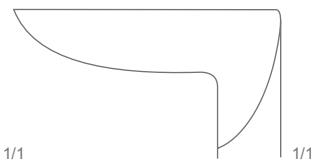

67-982-04
26.5 cm (10 1/4")

Stille-Liston Bone Cutting Forcep
Compound Action

Operating Scissors
Chirurgische Scheren
Tijeras quirúrgicas
Ciseaux chirurgicaux
Forbici per chirurgia



67-958-27
Liston-Key Bone Cutting Forcep
Compound Action
Overall Length 25.5 cm (10")



67-987-25
Semb Bone Cutting Forcep
Compound Action
Overall Length 24.5 cm (9 3/4")

Suction Cannulas
Saugrohre
Tubos de aspiración
Tubes d'aspiration
Tubi d'aspirazione



87-091-20
Adson Suction Tube
12 Charr. Ø 4.0 mm
Overall Length 20 cm (8")



87-094-24
Frazier Suction Tube
10 Charr. Ø 3.3 mm
Overall Length 24 cm (9 1/2")

Suction Cannulas
 Saugrohre
 Tubos de aspiración
 Tubes d'aspiration
 Tubi d'aspirazione



Frazier Suction Tube
 Overall Length 19.5 cm (7 3/4")

87-101-06
 Ø 2.0 mm
 6 Charr.

87-101-07
 Ø 2.3 mm
 7 Charr.

87-101-08
 Ø 2.7 mm
 8 Charr.

87-101-09
 Ø 3.0 mm
 9 Charr.

87-101-10
 Ø 3.3 mm
 10 Charr.

87-101-11
 Ø 3.6 mm
 11 Charr.

87-101-12
 Ø 4.0 mm
 12 Charr.

87-101-15
 Ø 5.0 mm
 15 Charr.



Fergusson Suction Tube
 Overall Length 18 cm (7")

87-111-05
 Ø 1.7 mm
 5 Charr.

87-111-06
 Ø 2.0 mm
 6 Charr.

87-111-08
 Ø 2.5 mm
 8 Charr.

87-111-09
 Ø 3.0 mm
 9 Charr.

87-111-12
 Ø 4.0 mm
 12 Charr.

87-111-15
 Ø 5.0 mm
 15 Charr.

Suction Cannulas
 Saugrohre
 Tubos de aspiración
 Tubes d'aspiration
 Tubi d'aspirazione



87-113-02
 Ø 0.6 mm
 2 Charr.

87-113-03
 Ø 1.0 mm
 3 Charr.

87-113-04
 Ø 1.3 mm
 4 Charr.

87-113-05
 Ø 1.6 mm
 5 Charr.

87-113-06
 Ø 2.0 mm
 6 Charr.

87-113-07
 Ø 2.3 mm
 7 Charr.

87-113-08
 Ø 2.6 mm
 8 Charr.

87-113-09
 Ø 3.0 mm
 9 Charr.

87-113-10
 Ø 3.3 mm
 10 Charr.

87-113-11
 Ø 3.6 mm
 11 Charr.

87-113-12
 Ø 4.0 mm
 12 Charr.

Fukushima Tear Drop Suction Tube

Straight, Malleable
 Overall Length 16.5 cm (6 1/2")



87-115-02
 Ø 0.6 mm
 2 Charr.

87-115-03
 Ø 1.0 mm
 3 Charr.

87-115-04
 Ø 1.3 mm
 4 Charr.

87-115-05
 Ø 1.6 mm
 5 Charr.

87-115-06
 Ø 2.0 mm
 6 Charr.

87-115-07
 Ø 2.3 mm
 7 Charr.

87-115-08
 Ø 2.6 mm
 8 Charr.

87-115-09
 Ø 3.0 mm
 9 Charr.

87-115-10
 Ø 3.3 mm
 10 Charr.

87-115-11
 Ø 3.6 mm
 11 Charr.

87-115-12
 Ø 4.0 mm
 12 Charr.

Fukushima Tear Drop Suction Tube

Straight, Malleable
 Overall Length 18 cm (7")

THORAX, CARDIOVASCULAR SURGERY

Suction Cannulas
 Saugrohre
 Tubos de aspiración
 Tubes d'aspiration
 Tubi d'aspirazione



87-117-02
 Ø 0.6 mm
 2 Charr.

87-117-03
 Ø 1.0 mm
 3 Charr.

87-117-04
 Ø 1.3 mm
 4 Charr.

87-117-05
 Ø 1.6 mm
 5 Charr.

87-117-06
 Ø 2.0 mm
 6 Charr.

87-117-07
 Ø 2.3 mm
 7 Charr.

87-117-08
 Ø 2.6 mm
 8 Charr.

87-117-09
 Ø 3.0 mm
 9 Charr.

87-117-10
 Ø 3.3 mm
 10 Charr.

87-117-11
 Ø 3.6 mm
 11 Charr.

87-117-12
 Ø 4.0 mm
 12 Charr.

Fukushima Tear Drop Suction Tube
 Straight, Malleable
 Overall Length 20.5 cm (8")

Suction Cannulas
 Saugrohre
 Tubos de aspiración
 Tubes d'aspiration
 Tubi d'aspirazione



87-119-02
 Ø 0.6 mm
 2 Charr.

87-119-03
 Ø 1.0 mm
 3 Charr.

87-119-04
 Ø 1.3 mm
 4 Charr.

87-119-05
 Ø 1.6 mm
 5 Charr.

87-119-06
 Ø 2.0 mm
 6 Charr.

87-119-07
 Ø 2.3 mm
 7 Charr.

87-119-08
 Ø 2.6 mm
 8 Charr.

87-119-09
 Ø 3.0 mm
 9 Charr.

87-119-10
 Ø 3.3 mm
 10 Charr.

87-119-11
 Ø 3.6 mm
 11 Charr.

87-119-12
 Ø 4.0 mm
 12 Charr.

Fukushima Tear Drop Suction Tube

Straight, Malleable
 Overall Length 23 cm (9")

Suction Cannulas
 Saugrohre
 Tubos de aspiración
 Tubes d'aspiration
 Tubi d'aspirazione



87-120-02
 Ø 0.6 mm
 2 Charr.

87-120-03
 Ø 1.0 mm
 3 Charr.

87-120-04
 Ø 1.3 mm
 4 Charr.

87-120-05
 Ø 1.6 mm
 5 Charr.

87-120-06
 Ø 2.0 mm
 6 Charr.

87-120-07
 Ø 2.3 mm
 7 Charr.

87-120-08
 Ø 2.6 mm
 8 Charr.

87-120-09
 Ø 3.0 mm
 9 Charr.

87-120-10
 Ø 3.3 mm
 10 Charr.

87-120-11
 Ø 3.6 mm
 11 Charr.

87-120-12
 Ø 4.0 mm
 12 Charr.

Fukushima Tear Drop Suction Tube
 Straight, Malleable
 Overall Length 21 cm (8 1/4")

Suction Cannulas
 Saugrohre
 Tubos de aspiración
 Tubes d'aspiration
 Tubi d'aspirazione



87-121-02
 Ø 0.6 mm
 2 Charr.

87-121-03
 Ø 1.0 mm
 3 Charr.

87-121-04
 Ø 1.3 mm
 4 Charr.

87-121-05
 Ø 1.6 mm
 5 Charr.

87-121-06
 Ø 2.0 mm
 6 Charr.

87-121-07
 Ø 2.3 mm
 7 Charr.

87-121-08
 Ø 2.6 mm
 8 Charr.

87-121-09
 Ø 3.0 mm
 9 Charr.

87-121-10
 Ø 3.3 mm
 10 Charr.

87-121-11
 Ø 3.6 mm
 11 Charr.

87-121-12
 Ø 4.0 mm
 12 Charr.

Fukushima Tear Drop Suction Tube
 Angled, Semi Rigid
 Overall Length 21 cm (8 ¼")

Suction Cannulas
 Saugrohre
 Tubos de aspiración
 Tubes d'aspiration
 Tubi d'aspirazione



87-122-02
 Ø 0.6 mm
 2 Charr.

87-122-03
 Ø 1.0 mm
 3 Charr.

87-122-04
 Ø 1.3 mm
 4 Charr.

87-122-05
 Ø 1.6 mm
 5 Charr.

87-122-06
 Ø 2.0 mm
 6 Charr.

87-122-07
 Ø 2.3 mm
 7 Charr.

87-122-08
 Ø 2.6 mm
 8 Charr.

87-122-09
 Ø 3.0 mm
 9 Charr.

87-122-10
 Ø 3.3 mm
 10 Charr.

87-122-11
 Ø 3.6 mm
 11 Charr.

87-122-12
 Ø 4.0 mm
 12 Charr.

Fukushima Tear Drop Suction Tube

Straight, Malleable
 Overall Length 22 cm (8 3/4")

Suction Cannulas
 Saugrohre
 Tubos de aspiración
 Tubes d'aspiration
 Tubi d'aspirazione



87-123-02
 Ø 0.6 mm
 2 Charr.

87-123-03
 Ø 1.0 mm
 3 Charr.

87-123-04
 Ø 1.3 mm
 4 Charr.

87-123-05
 Ø 1.6 mm
 5 Charr.

87-123-06
 Ø 2.0 mm
 6 Charr.

87-123-07
 Ø 2.3 mm
 7 Charr.

87-123-08
 Ø 2.6 mm
 8 Charr.

87-123-09
 Ø 3.0 mm
 9 Charr.

87-123-10
 Ø 3.3 mm
 10 Charr.

87-123-11
 Ø 3.6 mm
 11 Charr.

87-123-12
 Ø 4.0 mm
 12 Charr.

Fukushima Tear Drop Suction Tube
 Angled, Semi Rigid
 Overall Length 23.5 cm (9 1/4")

Suction Cannulas
 Saugrohre
 Tubos de aspiración
 Tubes d'aspiration
 Tubi d'aspirazione



87-124-02

Ø 0.6 mm
 2 Charr.

87-124-03

Ø 1.0 mm
 3 Charr.

87-124-04

Ø 1.3 mm
 4 Charr.

87-124-05

Ø 1.6 mm
 5 Charr.

87-124-06

Ø 2.0 mm
 6 Charr.

87-124-07

Ø 2.3 mm
 7 Charr.

87-124-08

Ø 2.6 mm
 8 Charr.

87-124-09

Ø 3.0 mm
 9 Charr.

87-124-10

Ø 3.3 mm
 10 Charr.

87-124-11

Ø 3.6 mm
 11 Charr.

87-124-12

Ø 4.0 mm
 12 Charr.

Fukushima Tear Drop Suction Tube

Straight, Malleable
 Overall Length 24 cm (9 1/2")

Suction Cannulas
 Saugrohre
 Tubos de aspiración
 Tubes d'aspiration
 Tubi d'aspirazione

THORAX, CARDIOVASCULAR SURGERY



87-125-02
 Ø 0.6 mm
 2 Charr.

87-125-03
 Ø 1.0 mm
 3 Charr.

87-125-04
 Ø 1.3 mm
 4 Charr.

87-125-05
 Ø 1.6 mm
 5 Charr.

87-125-06
 Ø 2.0 mm
 6 Charr.

87-125-07
 Ø 2.3 mm
 7 Charr.

87-125-08
 Ø 2.6 mm
 8 Charr.

87-125-09
 Ø 3.0 mm
 9 Charr.

87-125-10
 Ø 3.3 mm
 10 Charr.

87-125-11
 Ø 3.6 mm
 11 Charr.

87-125-12
 Ø 4.0 mm
 12 Charr.

Fukushima Tear Drop Suction Tube
 Angled, Semi Rigid
 Overall Length 26 cm (10 1/4")

Suction Cannulas
 Saugrohre
 Tubos de aspiración
 Tubes d'aspiration
 Tubi d'aspirazione



87-126-02
 Ø 0.6 mm
 2 Charr.

87-126-03
 Ø 1.0 mm
 3 Charr.

87-126-04
 Ø 1.3 mm
 4 Charr.

87-126-05
 Ø 1.6 mm
 5 Charr.

87-126-06
 Ø 2.0 mm
 6 Charr.

87-126-07
 Ø 2.3 mm
 7 Charr.

87-126-08
 Ø 2.6 mm
 8 Charr.

87-126-09
 Ø 3.0 mm
 9 Charr.

87-126-10
 Ø 3.3 mm
 10 Charr.

87-126-11
 Ø 3.6 mm
 11 Charr.

87-126-12
 Ø 4.0 mm
 12 Charr.

Fukushima Tear Drop Suction Tube
 Straight, Malleable
 Overall Length 26.5 cm (10 1/2")

Suction Cannulas
 Saugrohre
 Tubos de aspiración
 Tubes d'aspiration
 Tubi d'aspirazione



87-135-05
 Ø 1.7 mm
 5 Charr.

87-135-06
 Ø 2.0 mm
 6 Charr.

87-135-07
 Ø 2.3 mm
 7 Charr.

87-135-08
 Ø 2.6 mm
 8 Charr.

87-135-09
 Ø 3.0 mm
 9 Charr.

Plester Suction Tube

With Grip Plate, Cutoff Hole and Stylet
 Overall Length 20 cm (8")



87-245-23
Andrews-Pynchon Suction Tube (Complete)
 Ø 2.0 mm
 Overall Length 23 cm (9")



Morse-Andrews Suction Tube

87-247-01
 Ø 3.0 mm
 21 cm (8 ¼")

87-247-02
 Ø 4.0 mm
 22.5 cm (8 ¾")

87-247-03
 Ø 4.0 mm
 24.5 cm (9 ½")

Suction Cannulas
Saugrohre
Tubos de aspiración
Tubes d'aspiration
Tubi d'aspirazione



87-251-27
Yankauer Suction Tube (Complete)
Central Bore, 2.0 mm
Overall Length 31 cm (12 1/4")



87-251-27 FO
Yankauer Suction Tube (With Fiber Optic Carrier Complete)
Central Bore, 2.0 mm
Overall Length 31 cm (12 1/4")



87-253-27
Yankauer Suction Tube (Complete)
Central Bore, 4.8 mm
Overall Length 31 cm (12 1/4")

Operating Scissors
 Chirurgische Scheren
 Tijeras quirúrgicas
 Ciseaux chirurgicaux
 Forbici per chirurgia



87-255-00
Yankauer Suction Tube Complete (Detachable)
 With Handle, 4 Tube, Suction Tip and Tube Connector
 Overall Length 31 cm (21 1/4")



87-255-01
Yankauer Suction Handle Only
 Overall Length 15 cm (6")



87-255-02
Yankauer Suction Connector Only
 Oval Shaped
 Overall Length 2.5 cm (1")



87-255-10
Yankauer Suction Tube
 Fig. 0
 Overall Length 10 cm (4")



87-255-11
Yankauer Suction Tube
 Fig. 1
 Overall Length 10 cm (4")



87-255-12
Yankauer Suction Tube
 Fig. 2
 Overall Length 10 cm (4")



87-255-13
Yankauer Suction Tube
 Fig. 3
 Overall Length 13.5 cm (5 1/4")

THORAX, CARDIOVASCULAR SURGERY

Operating Scissors
Chirurgische Scheren
Tijeras quirúrgicas
Ciseaux chirurgicaux
Forbici per chirurgia



87-255-15
Yankauer Suction Tip



87-270-22
Poole Suction Tube
Ø 10.0 mm
Overall Length 22 cm (8 3/4")



87-271-22
Poole Suction Tube
Ø 8.0 mm
Overall Length 22.5 cm (8 3/4")



87-273-20
Poole-Baby Suction Tube
Ø 5.5 mm
Overall Length 22 cm (8")



87-281-35
Cooley Suction Tube
Ø 8.0 mm
Overall Length 36 cm (14 1/4")



Operating Scissors
Chirurgische Scheren
Tijeras quirúrgicas
Ciseaux chirurgicaux
Forbici per chirurgia



87-283-31
Cooley Suction Tube
Ø 10.0 mm
With Perforated Screw Tip
Overall Length 31 cm (12 ¼")



87-285-30
Cooley Suction Tube
Ø 7.0 mm
With Perforated Screw Tip
Overall Length 31 cm (12 ¼")



87-287-33
Cooley Suction Tube
Ø 8.0 mm
With Perforated Screw Tip
Overall Length 36 cm (12 ¼")



87-291-27
DeBakey Suction Tube
Ø 9.0 mm
Overall Length 27.5 cm (12 ¼")



87-293-16
Ø 5.0 mm, Ø 9.0 mm
16 cm (6 ¼")

87-293-27
Ø 5.0 mm, Ø 9.0 mm
27 cm (10 ¾")

DeBakey Suction Tube

THORAX, CARDIOVASCULAR SURGERY

Operating Scissors
 Chirurgische Scheren
 Tijeras quirúrgicas
 Ciseaux chirurgicaux
 Forbici per chirurgia



87-301-32
Finsterer Suction Tube
 Ø 15.0 mm
 Overall Length 32 cm (12 3/4")



87-410-00
Pudendus Anaesthesia Needle
 Complete With Cannula
 Overall Length 18 cm (7")



Hypodermic Needle

87-400-01

Fig. 1
 0.85 x 40 mm

87-400-02

Fig. 2
 0.80 x 35 mm

87-400-12

Fig. 12
 0.70 x 32 mm

87-400-14

Fig. 14
 0.65 x 30 mm

87-400-16

Fig. 16
 0.60 x 25 mm

87-400-18

Fig. 18
 0.50 x 23 mm

87-400-20

Fig. 20
 0.45 x 18 mm



Vein Cannula
 Button End, With Tube Connector

87-420-12

Ø 1.2 x 80 mm

87-420-15

Ø 1.5 x 80 mm



Operating Scissors
 Chirurgische Scheren
 Tijeras quirúrgicas
 Ciseaux chirurgicaux
 Forbici per chirurgia

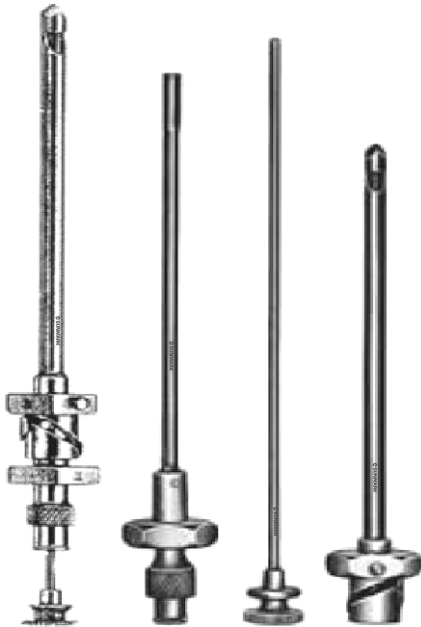

87-464-13
Abrams Pleural Biopsy Needle Set
 Ø 4.0 mm
 Overall Length 13.5 cm (5 1/2")



Menghini Liver Puncture Needle
 Blind Lever Puncture, With Stopping Needle

- | | | |
|------------------------------------|------------------------------------|------------------------------------|
| 87-470-10
Ø 1.0 x 35 mm | 87-470-15
Ø 1.0 x 70 mm | 87-470-20
Ø 1.2 x 70 mm |
| 87-470-25
Ø 1.2 x 100 mm | 87-470-30
Ø 1.4 x 70 mm | 87-470-35
Ø 1.4 x 100 mm |
| 87-470-40
Ø 1.6 x 70 mm | 87-470-50
Ø 1.8 x 100 mm | |

THORAX, CARDIOVASCULAR SURGERY



87-472-14
 Ø 1.0 x 35 mm
87-472-18
 Ø 1.8 x 168 mm

Menghini Liver Puncture Needle
 For Controlled Blind Lever Puncture



87-500-20
Verres Insufflation Cannula
 With Luer Lock Connection
 Ø 2.0 x 100 mm



87-502-20
Verres Insufflation Cannula
 With Luer Lock Connection
 Ø 2.0 x 120 mm

Operating Scissors
Chirurgische Scheren
Tijeras quirúrgicas
Ciseaux chirurgicaux
Forbici per chirurgia



87-520-15

Ø 1.5 mm

87-520-20

Ø 2.0 mm

87-520-25

Ø 2.5 mm

87-520-30

Ø 3.0 mm

87-520-40

Ø 4.0 mm

Vollmar Vessel Irrigation Cannula

With Luer Lock Connection
Overall Length 6 cm (2 1/4")

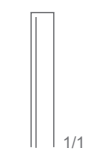

87-530-03
Ø 3.0 mm

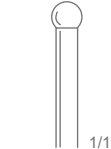

87-530-04
Ø 4.0 mm

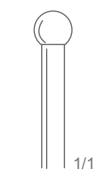

87-530-05
Ø 5.0 mm

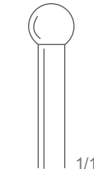

87-530-06
Ø 6.0 mm

Schmid Vessel Irrigation Cannula

Malleable, With Luer Lock Connection
Overall Length 15 cm (6")



87-536-30

Abraham Laryngeal Cannula

Malleable, With Luer Lock Connection
Ø 3.0 mm
Overall Length 15 cm (6")



Operating Scissors
Chirurgische Scheren
Tijeras quirúrgicas
Ciseaux chirurgicaux
Forbici per chirurgia

THORAX, CARDIOVASCULAR SURGERY



87-548-05
DeBakey Heparin Cannula
With Luer Lock Connection
Ø 5.0 mm
Overall Length 16 cm (6 ¼")



87-550-08
Ø 2.9 mm x 0.8 mm
87-550-10
Ø 2.9 mm x 0.8 mm

Mock Heparin Flushing Needle
Button End With Luer Lock Connection
Overall Length 6.5 cm (2 ½")



87-560-00
Tibbs Arterial Cannula Set

Operating Scissors
 Chirurgische Scheren
 Tijeras quirúrgicas
 Ciseaux chirurgicaux
 Forbici per chirurgia



87-701-08

2.7 mm - 8 Charr.

87-701-12

4.0 mm - 12 Charr.

87-701-16

5.3 mm - 16 Charr.

87-701-10

3.3 mm - 10 Charr.

87-701-14

4.7 mm - 14 Charr.

87-701-18

6 mm - 18 Charr.



87-703-08

2.7 mm - 8 Charr.

87-703-12

4.0 mm - 12 Charr.

87-703-16

5.3 mm - 16 Charr.

87-703-10

3.3 mm - 10 Charr.

87-703-14

4.7 mm - 14 Charr.

87-703-18

6 mm - 18 Charr.

Redon Guide Needle

Knife Tip
 Overall Length 19.5 cm (7 3/4")

Redon Guide Needle

Knife Tip
 Overall Length 19.5 cm (7 3/4")



87-705-08

2.7 mm - 8 Charr.

87-705-12

4.0 mm - 12 Charr.

87-705-16

5.3 mm - 16 Charr.

87-705-10

3.3 mm - 10 Charr.

87-705-14

4.7 mm - 14 Charr.

87-705-18

6 mm - 18 Charr.



87-707-08

2.7 mm - 8 Charr.

87-707-12

4.0 mm - 12 Charr.

87-707-16

5.3 mm - 16 Charr.

87-707-10

3.3 mm - 10 Charr.

87-707-14

4.7 mm - 14 Charr.

87-707-18

6 mm - 18 Charr.

Redon Guide Needle

Lancet Tip
 Overall Length 19.5 cm (7 3/4")

Redon Guide Needle

Trocar Tip
 Overall Length 19.5 cm (7 3/4")

Intestinal and Tissue Grasping Forceps
 Darm- und Gewebefasszangen
 Pinzas para intestinos y tejidos
 Pincers pour saisir intestins et tissus
 Pinze per afferrare intestino e tessuti

THORAX, CARDIOVASCULAR SURGERY



74-010-12
Allis-Baby Intestinal and Tissue Grasping Forcep
 4 x 5 Teeth
 Overall Length 13 cm (5")



74-012-15
Allis-Baby Intestinal and Tissue Grasping Forcep
 4 x 5 Teeth
 Overall Length 15.5 cm (6")



Intestinal and Tissue Grasping Forceps
 Darm- und Gewebefasszangen
 Pinzas para intestinos y tejidos
 Pincers pour saisir intestins et tissus
 Pinze per afferrare intestino e tessuti

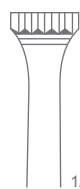

74-015-15
15.5 cm (6")



74-015-19
19 cm (7 1/2")

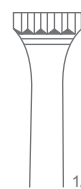

74-015-25
25.5 cm (10")



Allis-Baby Intestinal and Tissue Grasping Forcep
5 x 6 Teeth

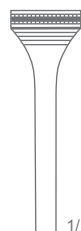

74-020-16
15.5 cm (6")

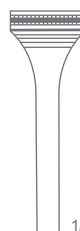

74-020-20
20 cm (8")

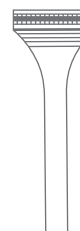

74-020-25
24.5 cm (9 3/4")



74-020-30
30 cm (11 3/4")

Allis Atrauma Intestinal and Tissue Grasping Forcep

Intestinal and Tissue Grasping Forceps
 Darm- und Gewebefasszangen
 Pinzas para intestinos y tejidos
 Pinces pour saisir intestins et tissus
 Pinze per afferrare intestino e tessuti

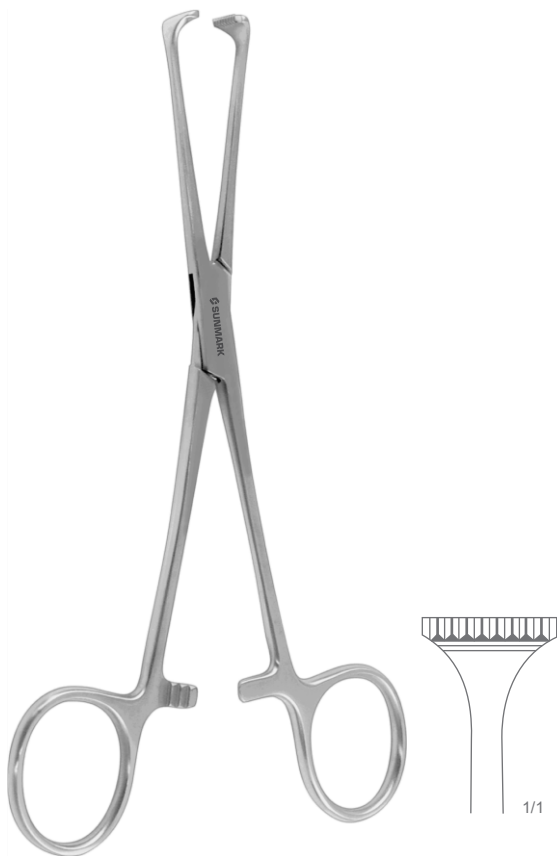

74-024-15
Allis-Adair Intestinal and Tissue Grasping Forcep
 10 x 11 Teeth
 Overall Length 16 cm (6 1/4")



74-026-15
Boys-Allis Intestinal and Tissue Grasping Forcep
 5 x 6 Teeth
 Overall Length 15.5 cm (6")

Intestinal and Tissue Grasping Forceps
 Darm- und Gewebefasszangen
 Pinzas para intestinos y tejidos
 Pincès pour saisir intestins et tissus
 Pinze per afferrare intestino e tessuti



Judd-Allis Intestinal and Tissue Grasping Forcep
 3 x 4 Teeth

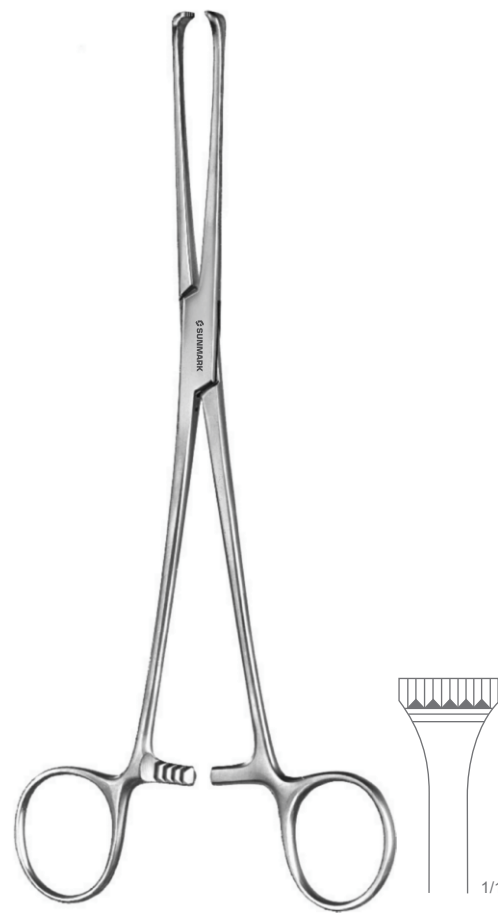
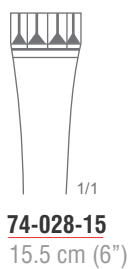

74-030-20
Thomas-Allis Intestinal and Tissue Grasping Forcep
 6 x 7 Teeth
 Overall Length 20.5 cm (8")



Intestinal and Tissue Grasping Forceps
 Darm- und Gewebefasszangen
 Pinzas para intestinos y tejidos
 Pincés pour saisir intestins et tissus
 Pinze per afferrare intestino e tessuti

THORAX, CARDIOVASCULAR SURGERY



74-032-20
Allis Intestinal and Tissue Grasping Forcep
 5 x 6 Teeth
 Overall Length 20 cm (8")

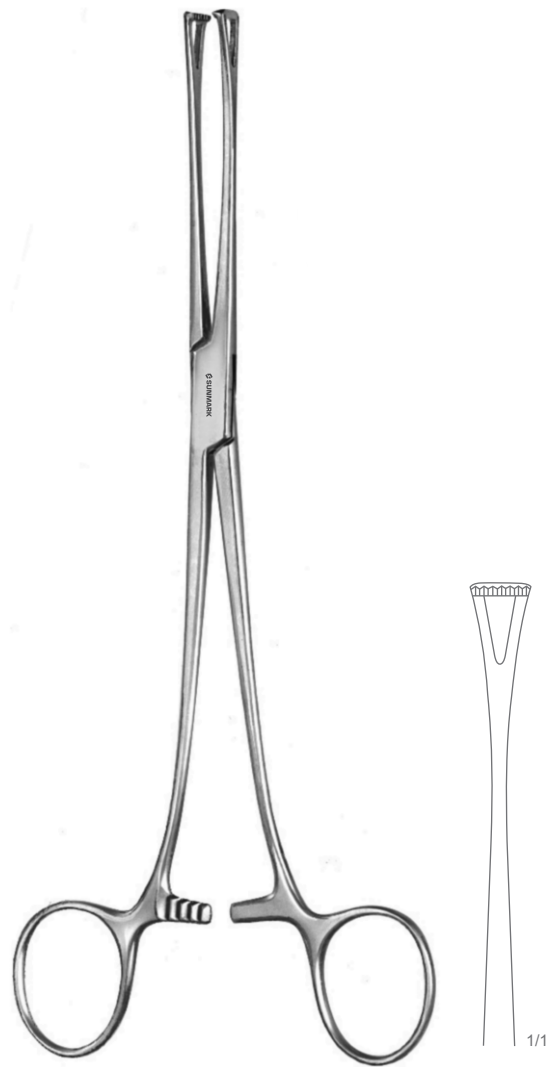

74-040-20
Lockwood Intestinal and Tissue Grasping Forcep
 Overall Length 20 cm (8")

Intestinal and Tissue Grasping Forceps
 Darm- und Gewebefasszangen
 Pinzas para intestinos y tejidos
 Pincès pour saisir intestins et tissus
 Pinze per afferrare intestino e tessuti

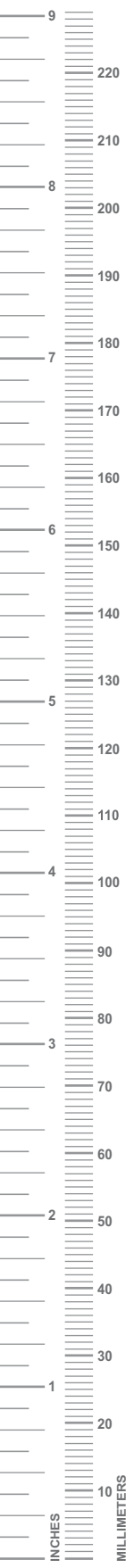

74-042-18
Littlewood Intestinal and Tissue Grasping Forcep
 Overall Length 18.5 cm (7 1/4")



74-050-16
Williams Intestinal and Tissue Grasping Forcep
 Overall Length 16.5 cm (6 1/2")

Intestinal and Tissue Grasping Forceps
 Darm- und Gewebefasszangen
 Pinzas para intestinos y tejidos
 Pincés pour saisir intestins et tissus
 Pinze per afferrare intestino e tessuti

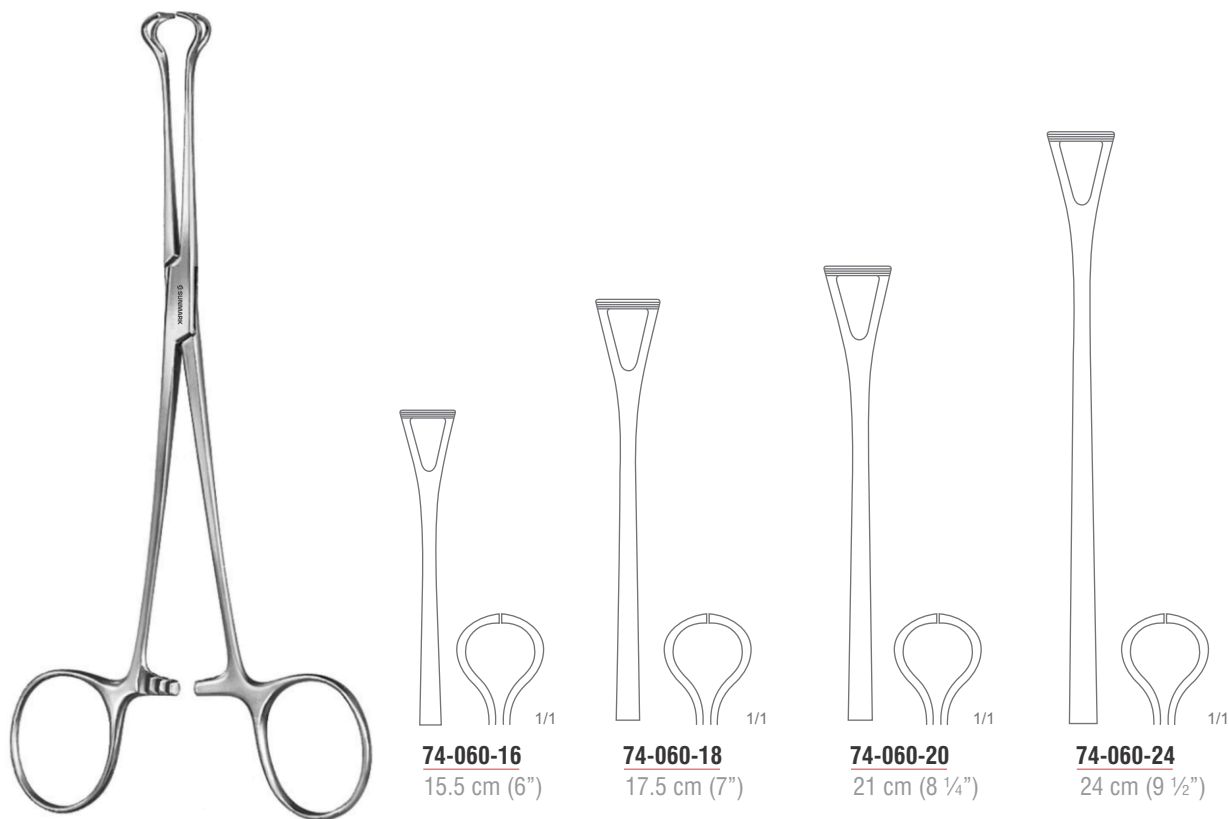

ULTRA GRIP[™]
UltraGrip™ TC Babcock Intestinal and Tissue Grasping Forcep

Babcock Intestinal and Tissue Grasping Forcep

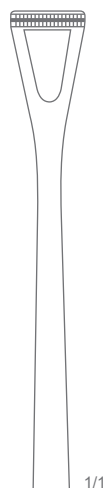
THORAX, CARDIOVASCULAR SURGERY

Intestinal and Tissue Grasping Forceps
 Darm- und Gewebefasszangen
 Pinzas para intestinos y tejidos
 Pincès pour saisir intestins et tissus
 Pinze per afferrare intestino e tessuti

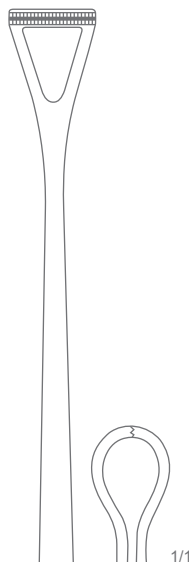

74-062-16
16 cm (6 1/4")



74-062-20
20.5 cm (8")

Atrauma™

Babcock Atrauma Intestinal and Tissue Grasping Forcep



74-070-20
UltraGrip™ TC Duval Intestinal and Tissue Grasping Forcep
Overall Length 20.5 cm (8")

ULTRA GRIP X™

Intestinal and Tissue Grasping Forceps
 Darm- und Gewebefasszangen
 Pinzas para intestinos y tejidos
 Pincés pour saisir intestins et tissus
 Pinze per afferrare intestino e tessuti



Duval Intestinal and Tissue Grasping Forcep

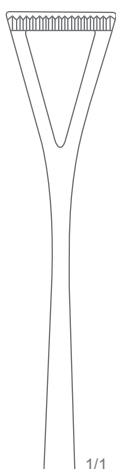

74-072-18
Narrow Jaw
18 cm (7")

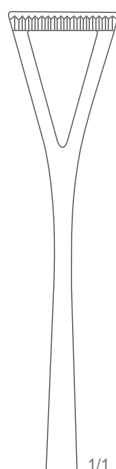

74-072-20
Narrow Jaw
18 cm (7")

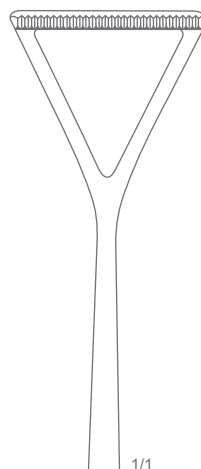

74-074-20
Wide Jaw
20.5 cm (8")

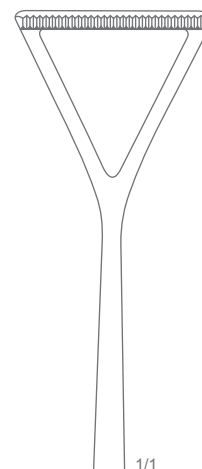

74-074-23
Wide Jaw
23 cm (9")

Nerve Hooks
Nervhaken
Ganchos para nervios
Crochets à nerfs
Uncini per nervi



78-040-01

Fig. 1
Ø 1.0 mm
19 cm (7 ½")

1/1



78-040-02

Fig. 2
Ø 1.6 mm
19.5 cm (7 ¾")

1/1

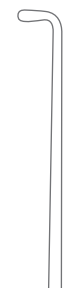

78-042-01

Fig. 1
Ø 1.0 mm
28 cm (11")

1/1



78-042-02

Fig. 2
Ø 1.6 mm
28.5 cm (11")

1/1

Cushing Nerve Hook
Blunt



78-048-01

Fig. 1

1/1



78-048-02

Fig. 2

1/1



78-048-03

Fig. 3

1/1

Graefe Nerve Hook
Blunt
Overall Length 14 cm (5 ½")

Nerve Hooks
Nervhaken
Ganchos para nervios
Crochets à nerfs
Uncini per nervi



Size
Or
Linework
Required

78-050-14
Angled 90°
Ø 1.4 mm
14.5 cm (5 3/4")



78-050-20
Angled 90°
Ø 1.4 mm
20 cm (8")



78-052-20
Angled 30°
Ø 1.4 mm
20.5 cm (8")

Crile Nerve Hook

Hooklets
Wundhäkchen
Ganchitos
Crochetes
Divaricatori



Wound Retractor
Small Curved
Overall Length 16.5 cm (6 1/2")



Hooklets
Wundhäkchen
Ganchitos
Crochetes
Divaricatori



78-104-02
Sharp

78-104-03
Sharp

78-104-04
Sharp



78-105-02
Blunt

78-105-03
Blunt

78-105-04
Blunt

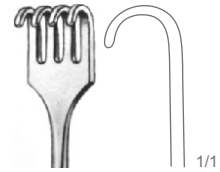
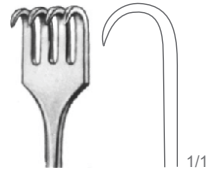

78-108-01
Sharp

78-108-02
Blunt

Wound Retractor
Flexible Prongs
Overall Length 16 cm (6 1/4")

Wound Retractor
Overall Length 16.5 cm (6 1/2")

Hooklets
Wundhäkchen
Ganchitos
Crochetes
Divaricatori

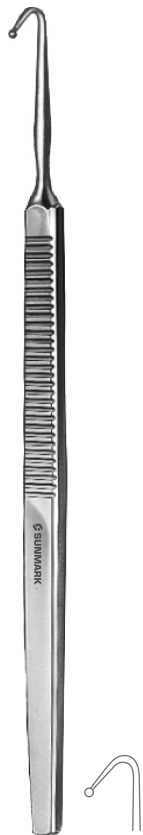

78-110-12
Moldestad Vessel Hook
Overall Length 12 cm (4 3/4")



Desmarres Lid Retractor
Overall Length 16 cm (6 1/4")



78-120-08
8.0 mm



78-120-10
10.0 mm



78-120-12
12.0 mm

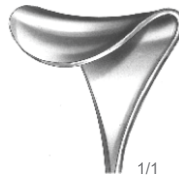

78-120-14
14.0 mm

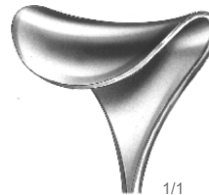

78-120-16
16.0 mm



78-120-18
18.0 mm

Saddle Hooks
Sattelhäkchen
Ganchos en forma de silla
Ecarteurs sous forme de selle
Divaricatori a forma di sella

THORAX, CARDIOVASCULAR SURGERY



Lid Retractor
Hollow Blade
Overall Length 16 cm (6 ¼")



78-122-12
12.0 mm



78-122-14
14.0 mm



78-122-16
16.0 mm



78-122-18
18.0 mm



78-124-14
Masing Lid Retractor
12.0 mm
Overall Length 14 cm (5 ½")





Hooklets
Wundhäkchen
Ganchitos
Crochetes
Divaricatori



Mini-Langenbeck Retractor
Overall Length 16 cm (6 1/4")



78-130-10
10 x 6 mm

78-130-20
20 x 6 mm

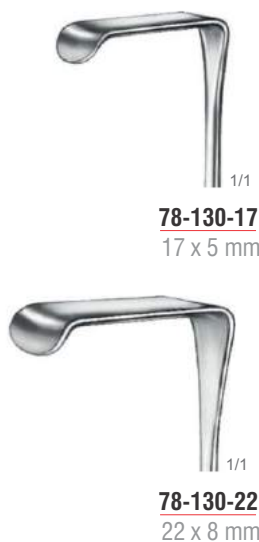

78-130-17
17 x 5 mm

78-130-22
22 x 8 mm



Langenbeck-Green Retractor
Overall Length 16 cm (6 1/4")



78-132-16
16 x 6 mm

78-132-24
24 x 6 mm

Hooklets
Wundhäkchen
Ganchitos
Crochetes
Divaricatori



78-136-16
Wound Retractor
Two Blunt Prongs
14 x 8 mm
Overall Length 16 cm (6 1/4")



Senn-Green Retractor
Overall Length 15 cm (6")

78-156-01
Fig. 1
20 x 6 mm

78-156-02
Fig. 2
10 x 6 mm



78-158-14
Ragnell-Davis Retractor
8 x 4 mm - 15 x 5.5 mm
Overall Length 14 cm (5 1/2")

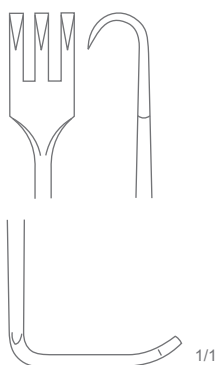
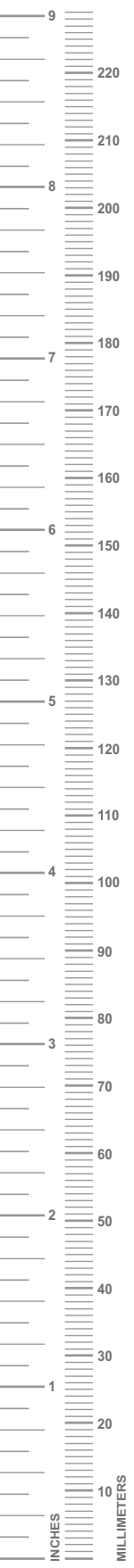

78-162-16
Sharp
20 x 7 mm

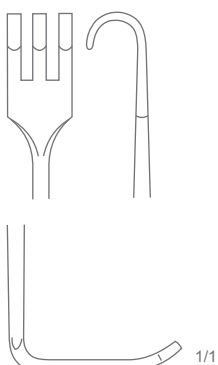

78-163-16
Blunt
20 x 7 mm

Senn-Miller Retractor
Overall Length 16 cm (6 1/2")

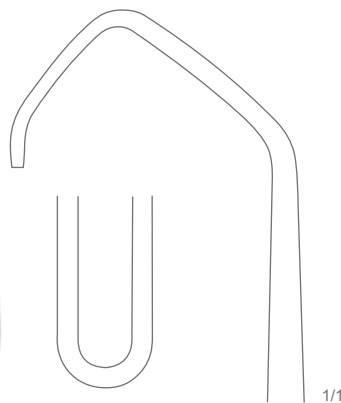

78-170-20
Cushing Retractor/Saddle Hook
Overall Length 20.5 cm (8")

Saddle Hooks
Sattelhäkchen
Ganchos en forma de silla
Ecarteurs sous forme de selle
Divaricatori a forma di sella

THORAX, CARDIOVASCULAR SURGERY



Cushing Retractor/Saddle Hook
Overall Length 20.5 cm (8")

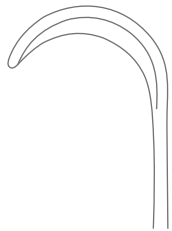

Cushing Retractor/Saddle Hook
Overall Length 24 cm (9 1/2")

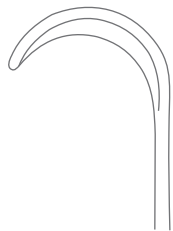

Saddle Hooks, Vein Hooks
 Sattelhäkchen, Venenhäkchen, Wundhäkchen
 Ganchos en forma de silla, Ganchitos para venas
 Ecarteurs sous forme de selle, Ecarteurs pour veines
 Divaricatori a forma di sella, Divaricatori per venia

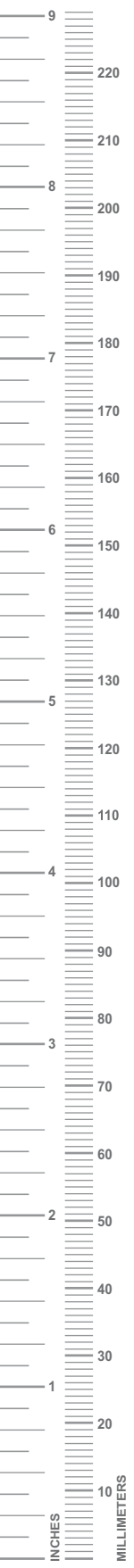

Gil-Vernet Retractor/Saddle Hook
 Overall Length 24 cm (9 1/2")

78-176-04
 4.0 mm

78-176-06
 6.0 mm



78-176-08
 8.0 mm



78-176-11
 11.0 mm

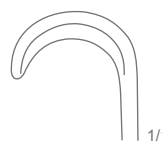

78-176-15
 15.0 mm

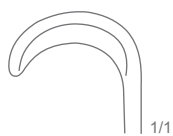

78-176-17
 17.0 mm

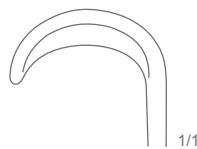

78-176-20
 20.0 mm

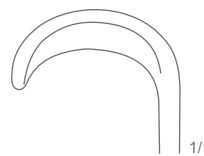

78-176-23
 23.0 mm



Brom Vein Hook
 Overall Length 19.5 cm (7 3/4")



78-178-01

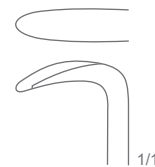

78-178-02

Vein Hooks
Wundhäkchen
Ganchitos para venas
Ecarteurs pour veines
Divaricatori per venia

THORAX, CARDIOVASCULAR SURGERY

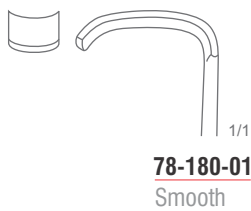

Strandell-Stille Retractor
Overall Length 19 cm (7 3/4")

Retractors
Wundhaken, Wundhäkchen
Separadores
Ecarteurs
Divaricatori

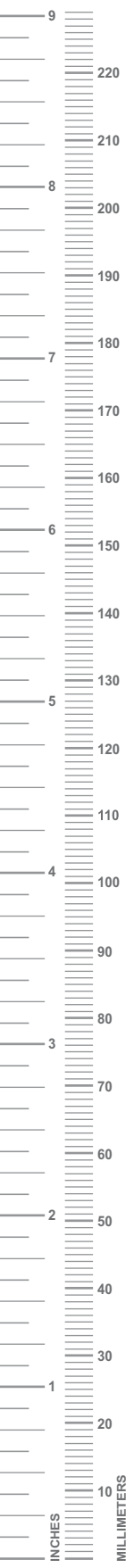

Volkman Retractor
Overall Length 22 cm (8 3/4")

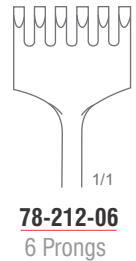
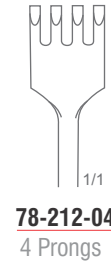
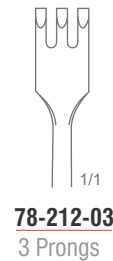
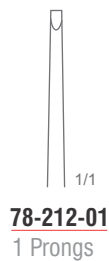
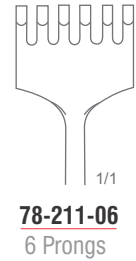
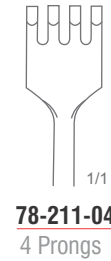
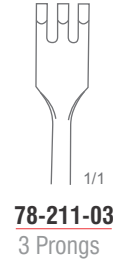
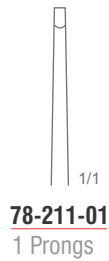
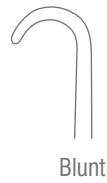
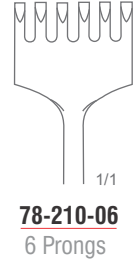
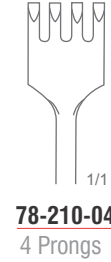
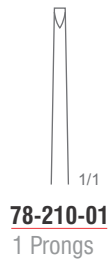

Retractors
Wundhaken, Wundhäkchen
Separadores
Ecarteurs
Divaricatori



78-214-01
Volkman Retractor
Sharp, 1 Prong
Overall Length 21.5 cm (8 ½")



78-215-01
Volkman Retractor
Blunt, 1 Prong
Overall Length 21.5 cm (8 ½")



78-218-01
Volkman Retractor
Sharp, 1 Prong
Overall Length 21.5 cm (8 ½")

Retractors
 Wundhaken, Wundhäkchen
 Separadores
 Ecarteurs
 Divaricatori



Kocher Retractor
 Overall Length 22 cm (8 3/4")

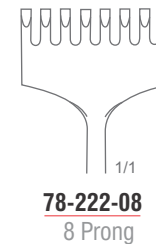
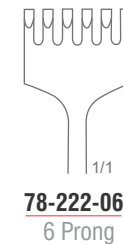
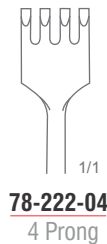
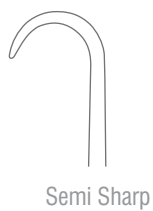
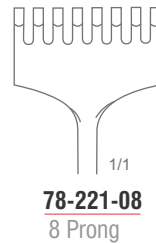
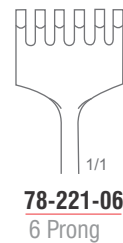
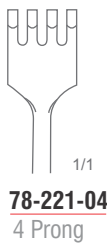
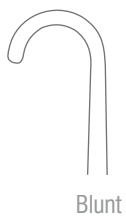
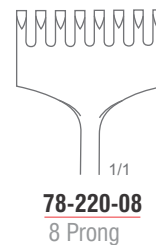
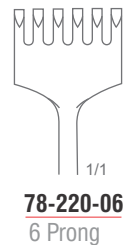
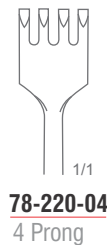
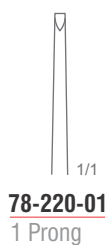
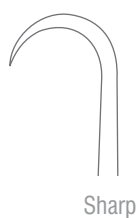

Retractors
Wundhaken, Wundhäkchen
Separadores
Ecarteurs
Divaricatori

THORAX, CARDIOVASCULAR SURGERY



78-224-03
Sharp
3 Prongs



78-224-04
Sharp
4 Prongs



78-225-03
Blunt
3 Prongs



78-225-04
Blunt
4 Prongs

Murphy Retractor
Overall Length 19.5 cm (7 3/4")



Retractors
Wundhaken, Wundhäkchen
Separadores
Ecarteurs
Divaricatori



Ollier Retractor
Overall Length 23 cm (9")



78-235-02
Wassmund Retractor
33 x 21 mm
Overall Length 20.5 cm (8")

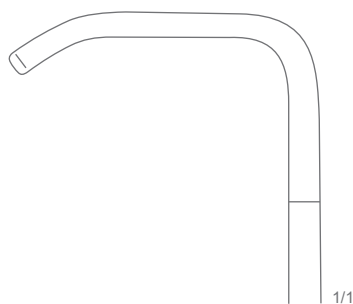

78-231-03
Blunt
36 x 30 mm
3 Prongs

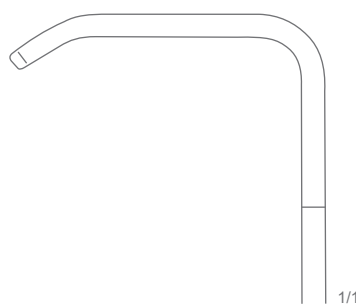

78-231-04
Blunt
36 x 60 mm
4 Prongs



Koerte Retractor
Overall Length 24.5 cm (9 3/4")

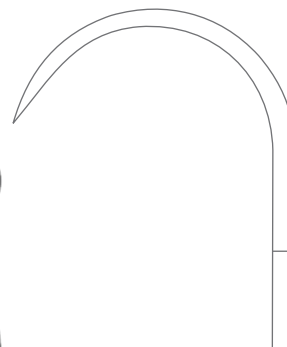

78-238-08
Sharp, 8 Prongs
40 x 30 mm

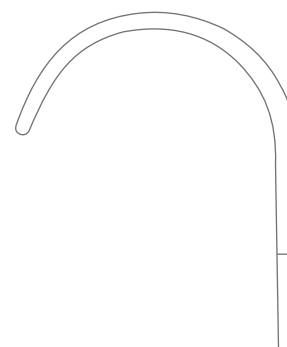

78-239-08
Blunt, 8 Prongs
40 x 30 mm

Retractors
Wundhaken, Wundhäkchen
Separadores
Ecarteurs
Divaricatori

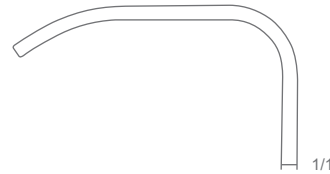

78-241-04
Blunt, 4 Prongs
40 x 40 mm

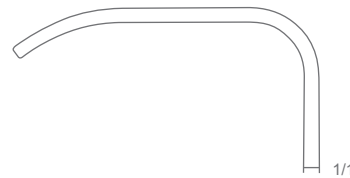

78-243-05
Blunt, 5 Prongs
45 x 50 mm

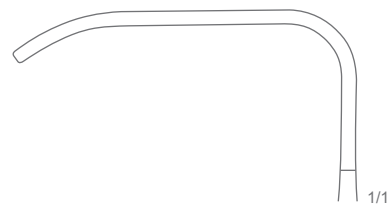

78-245-06
Blunt, 6 Prongs
50 x 60 mm

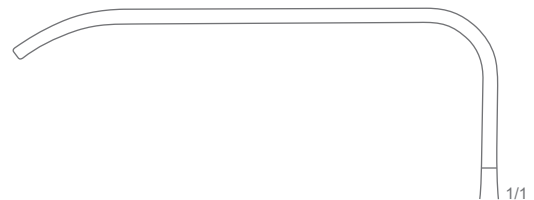

78-247-07
Blunt, 7 Prongs
70 x 70 mm



Israel Retractor
Overall Length 25.5 cm (10")

Retractors
Wundhaken, Wundhäkchen
Separadores
Ecarteurs
Divaricatori

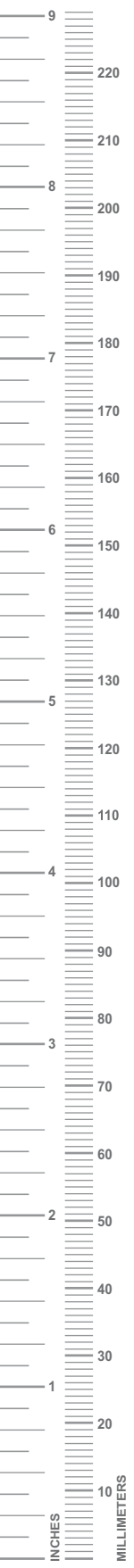

Langenbeck Retractor
Overall Length 22.5 cm (8 3/4")

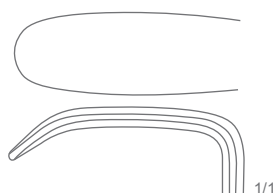

78-251-01
30 x 11

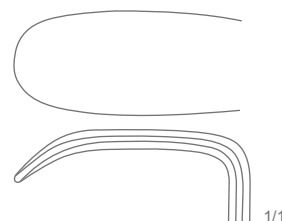

78-251-02
30 x 14

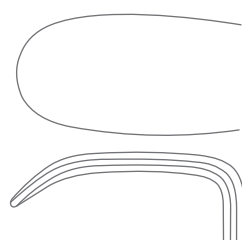

78-251-03
30 x 16

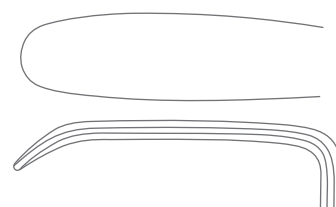

78-251-04
40 x 11

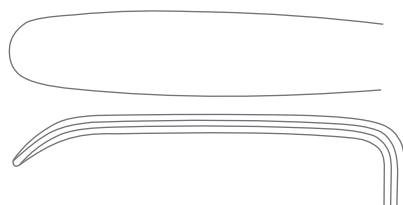

78-251-05
50 x 11

Retractors
Wundhaken, Wundhäkchen
Separadores
Ecarteurs
Divaricatori



78-255-00
Langenbeck Retractor
33 x 14
Overall Length 22.5 cm (8 3/4")



Langenbeck Retractor
Overall Length 21 cm (8 1/4")

78-257-01
55 x 20 mm

78-257-02
60 x 20 mm

78-257-03
63 x 20 mm

Retractors
Wundhaken, Wundhäkchen
Separadores
Ecarteurs
Divaricatori

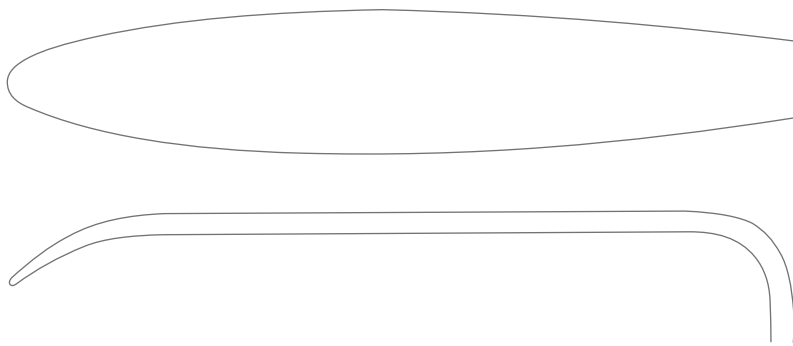

78-259-22
Langenbeck Retractor
85 x 15 mm
Overall Length 22.5 cm (8 ¾")

1/1



Retractors
Wundhaken, Wundhäkchen
Separadores
Ecarteurs
Divaricatori

THORAX, CARDIOVASCULAR SURGERY

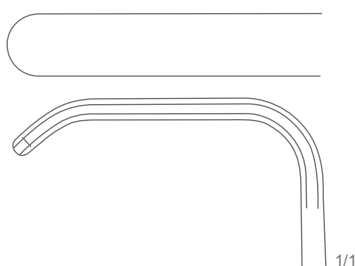

78-271-19
Lahey Retractor
31 x 6 mm
Overall Length 19.5 cm (7 3/4")

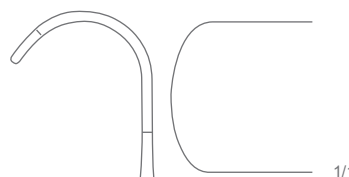

78-275-20
Little Retractor
13 x 15 mm
Overall Length 20 cm (8")

Retractors
Wundhaken, Wundhäkchen
Separadores
Ecarteurs
Divaricatori



Kocher Retractor
Overall Length 23 cm (9")

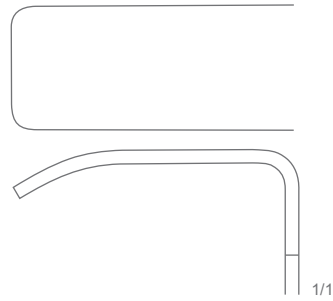

78-281-18
41 x 18 mm



78-281-20
61 x 20 mm



78-281-25
61 x 25 mm



78-281-30
75 x 30 mm



78-281-40
75 x 40 mm

Retractors
Wundhaken, Wundhäkchen
Separadores
Ecarteurs
Divaricatori

78

THORAX, CARDIOVASCULAR SURGERY



Kocher-Langenbeck Retractor
Overall Length 21.5 cm (8 1/2")

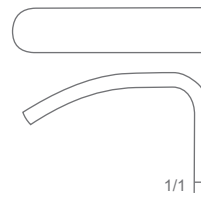

78-291-01
25 x 6 mm

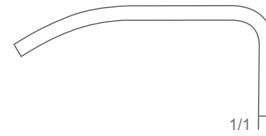

78-291-02
35 x 8 mm

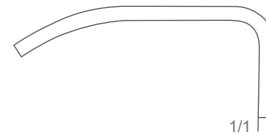

78-291-03
35 x 11 mm

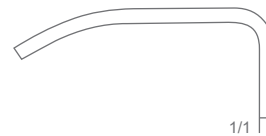

78-291-04
35 x 15 mm

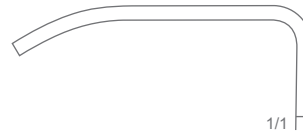

78-291-05
40 x 11 mm



78-291-06
55 x 11 mm

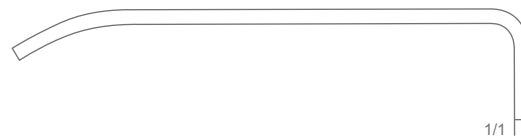

78-291-07
70 x 14 mm



78-291-08
80 x 12 mm



78-291-09
80 x 16 mm

Retractors
Wundhaken, Wundhäkchen
Separadores
Ecarteurs
Divaricatori

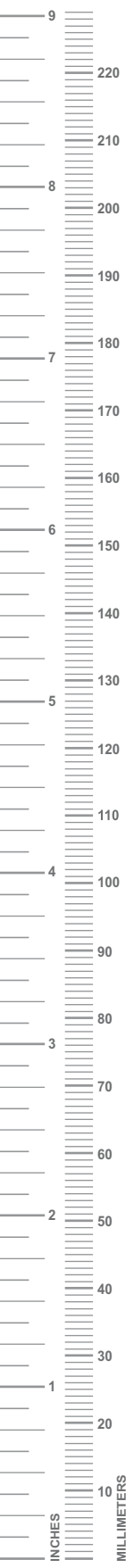

Kocher-Langenbeck Retractor
Overall Length 21.5 cm (8 1/2")

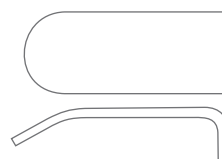

78-293-01
25 x 6 mm



78-293-02
40 x 13 mm



78-293-03
60 x 13 mm



78-293-04
40 x 18 mm



78-293-05
60 x 18 mm



78-293-06
85 x 18 mm



78-293-07
60 x 25 mm



78-293-08
85 x 25 mm

Retractors
Wundhaken, Wundhäkchen
Separadores
Ecarteurs
Divaricatori

THORAX, CARDIOVASCULAR SURGERY



78-295-01
45 x 15 mm

1/1

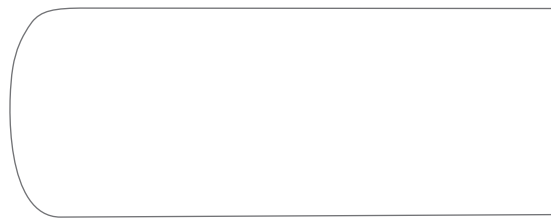

78-295-02
60 x 23 mm

1/1

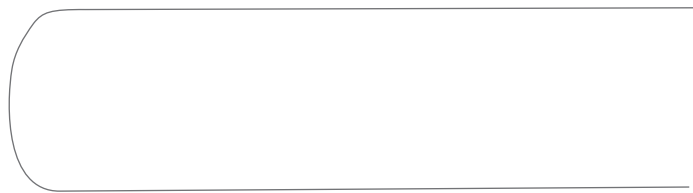

78-295-02
72 x 20 mm

1/1

Sauerbruch Retractor
Overall Length 22.5 cm (8 ¾")

Retractors
Wundhaken, Wundhäkchen
Separadores
Ecarteurs
Divaricatori



Kirsch Retractor
Overall Length 21 cm (8 1/4")

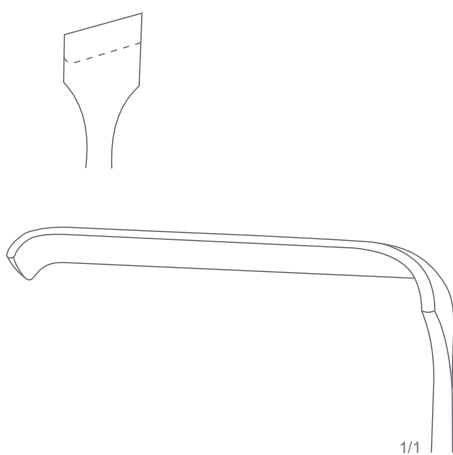

78-297-01
Left
60 x 11 mm

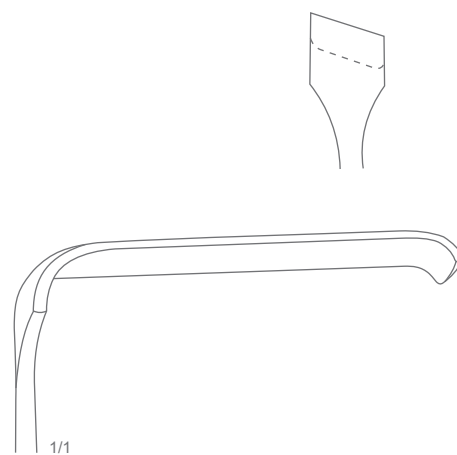

78-297-02
Right
60 x 11 mm

Retractors
Wundhaken, Wundhäkchen
Separadores
Ecarteurs
Divaricatori

THORAX, CARDIOVASCULAR SURGERY



Zenker Retractor

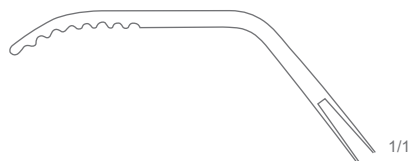

78-301-01
35 x 8 mm
25 cm (9 3/4")

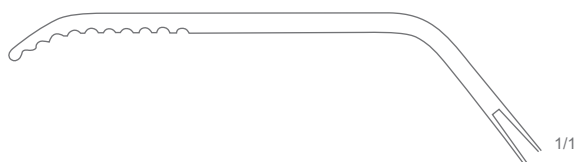

78-301-02
60 x 12 mm
26.5 cm (10 1/2")

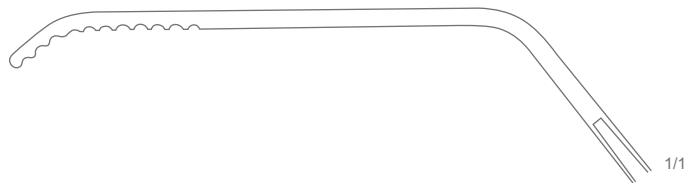

78-301-03
75 x 12 mm
27.5 cm (10 3/4")

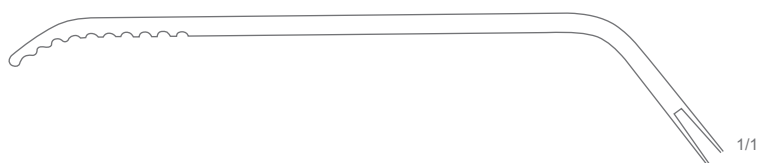

78-301-04
85 x 20 mm
28.5 cm (11 1/4")

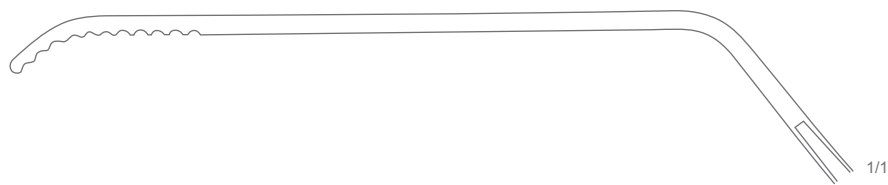

78-301-05
100 x 25 mm
30.5 cm (12")

Retractors
Wundhaken, Wundhäkchen
Separadores
Ecarteurs
Divaricatori



78-305-01
13 x 13 mm



78-305-02
12 x 16 mm

Koenig Retractor
Overall Length 18 cm (7")

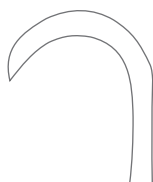

78-321-01
15.5 cm (6")

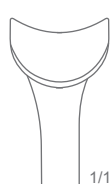

78-321-02
15.5 cm (6")

Koenig Retractor
Overall Length 21.5 cm (8 1/2")

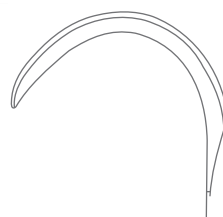

78-331-01
42 x 10 mm



78-331-02
42 x 15 mm



78-331-03
43 x 20 mm

Kocher Retractor
Overall Length 22 cm (8 1/2")

Retractors
Wundhaken, Wundhäkchen
Separadores
Ecarteurs
Divaricatori

THORAX, CARDIOVASCULAR SURGERY



78-325-20
Schoenborn Retractor
13 x 6 mm
Overall Length 20 cm (8")

78-337-20
Wound Retractor
Double Ended, 20 x 19 mm
Overall Length 20.5 cm (8")

78-341-23
Dissecting Hook
For Longitudinal
Dissection of Vessels
Overall Length 23.5 cm (9 1/2")

78-351-21
Durham Retractor
16 x 25 mm
Overall Length 21.5 cm (8 1/2")

Retractors
Wundhaken, Wundhäkchen
Separadores
Ecarteurs
Divaricatori

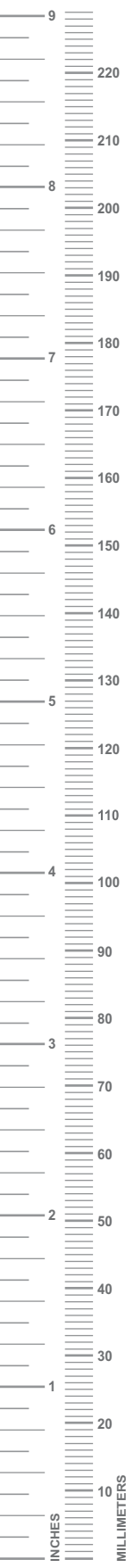

Middeldorf Retractor

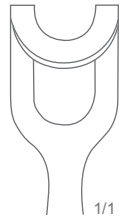
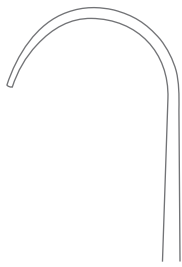

78-353-01
15 x 17 mm
21.5 cm (8 1/2")

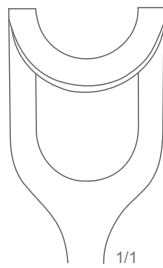

78-353-02
22 x 22 mm
23 cm (9")

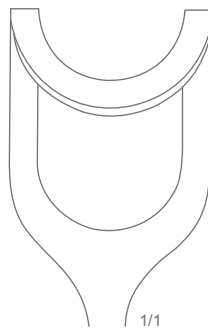

78-353-03
26 x 31 mm
24.5 cm (9 3/4")

Retractors
Wundhaken, Wundhäkchen
Separadores
Ecarteurs
Divaricatori



Middeldorf Retractor

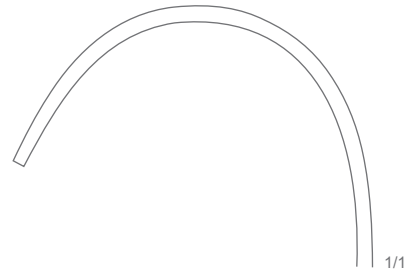

78-335-01
48 x 45 mm
27 cm (10 3/4")

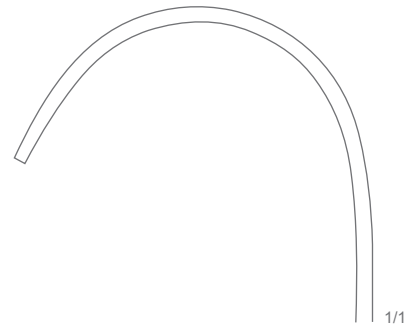

78-335-02
52 x 50 mm
27 cm (10 3/4")

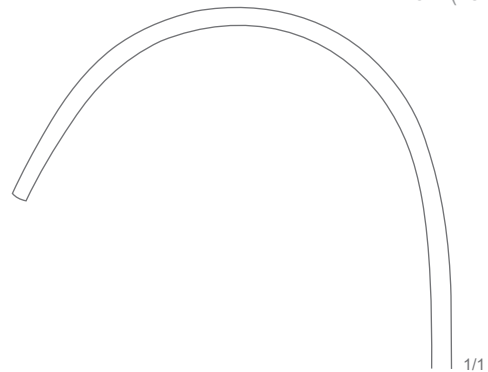

78-335-03
60 x 70 mm
28 cm (11")

Retractors
Wundhaken, Wundhäkchen
Separadores
Ecarteurs
Divaricatori



78-357-22
Greene Retractor
22 x 22 mm
Overall Length 22.5 cm (8 3/4")

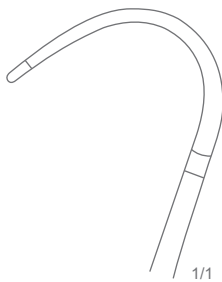

1/1



78-361-20
Buchs Retractor
38 x 18 mm
Overall Length 20.5 cm (8")



1/1

Retractors
Wundhaken, Wundhäkchen
Separadores
Ecarteurs
Divaricatori

THORAX, CARDIOVASCULAR SURGERY

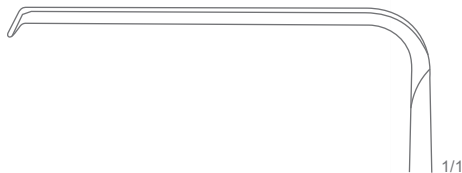

78-363-21
Kraemer Retractor
66 x 10 mm
Overall Length 21 cm (8 1/4")

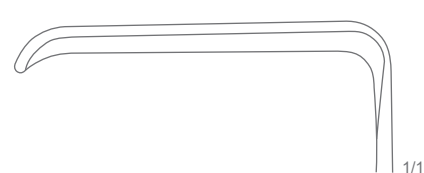

78-365-21
Caspar Retractor
67 x 17 mm
Overall Length 21 cm (8 1/4")

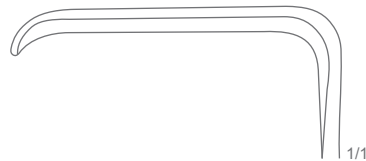

78-367-01
40 x 12 mm

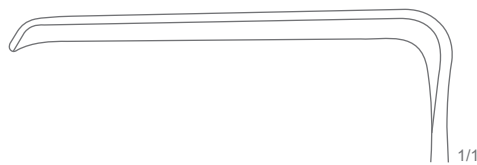

78-367-02
55 x 14 mm

Dockhorn Retractor
Overall Length 21 cm (8 1/4")

Retractors
Wundhaken, Wundhäkchen
Separadores
Ecarteurs
Divaricatori



78-369-18
Cloward Old Style Retractor
18 mm
Overall Length 18 cm (7")

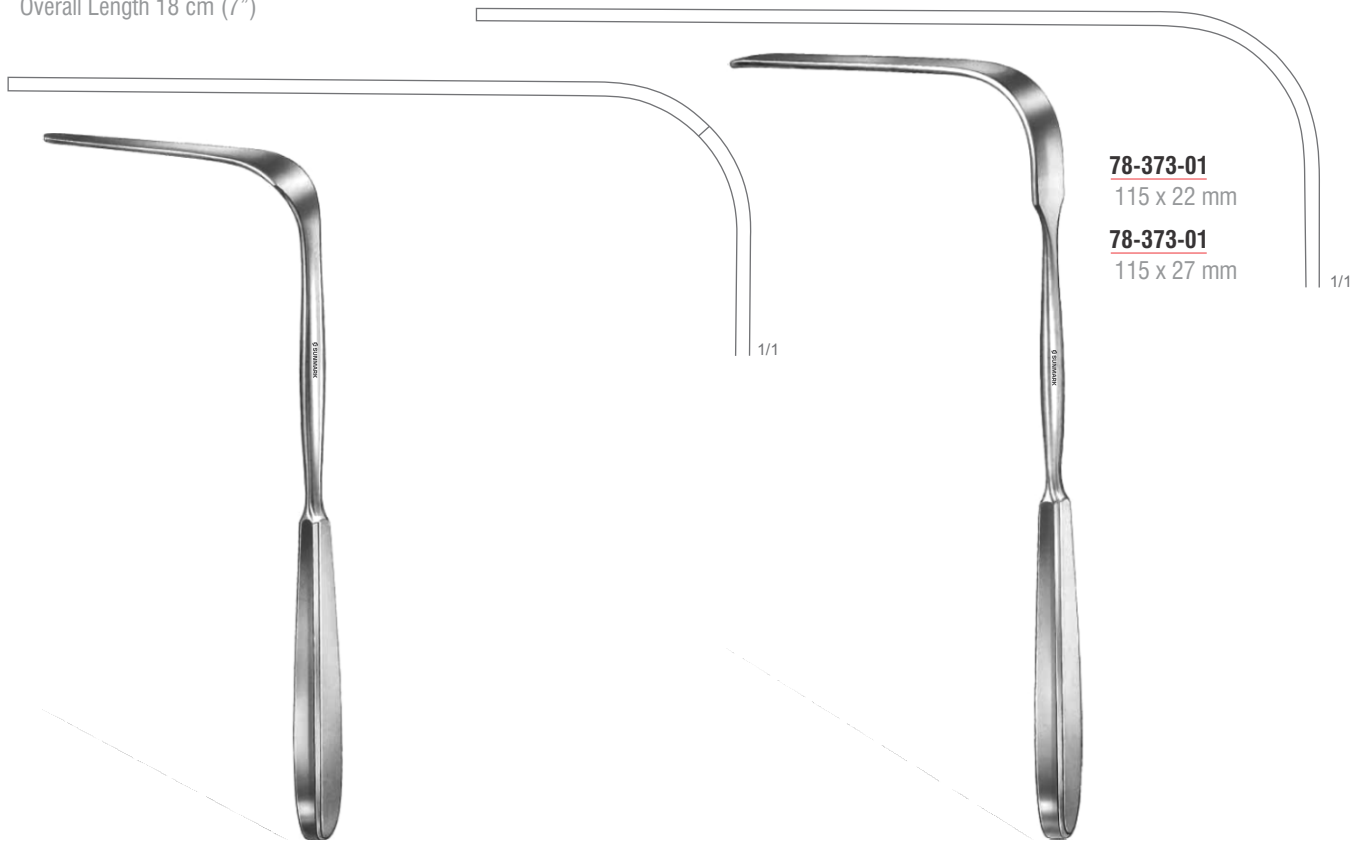

78-371-25
Martin Retractor
110 x 27 mm
Overall Length 26 cm (10 1/4")

Simon Retractor
Overall Length 28 cm (11")

78-373-01
115 x 22 mm

78-373-01
115 x 27 mm

Retractors
Wundhaken, Wundhäkchen
Separadores
Ecarteurs
Divaricatori

THORAX, CARDIOVASCULAR SURGERY



78-375-08
84 x 20 mm

78-375-10
104 x 25 mm

78-375-12
124 x 30 mm

78-375-13
130 x 30 mm

78-375-14
144 x 30 mm

78-375-16
160 x 30 mm

78-375-18
164 x 30 mm

1/1

Brunner Retractor
Overall Length 25.5 cm (10")



Retractors
Wundhaken, Wundhäkchen
Separadores
Ecarteurs
Divaricatori



78-377-08
82 x 20 mm

78-377-10
102 x 20 mm

78-377-12
122 x 30 mm

78-377-14
140 x 25 mm

78-377-16
162 x 30 mm

78-377-16
182 x 30 mm



Brunner Retractor
Overall Length 25.5 cm (10")

1/1

Retractors
Wundhaken, Wundhäkchen
Separadores
Ecarteurs
Divaricatori

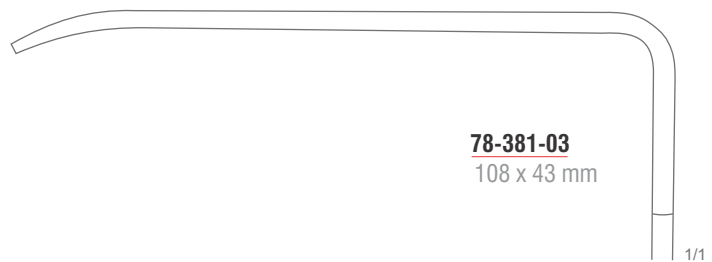

Coryllos Retractor
Overall Length 24 cm (9 1/2")

Retractors
Wundhaken, Wundhäkchen
Separadores
Ecarteurs
Divaricatori



Davidson Scapula Retractor



Richardson-Eastman Retractor



78-385-01
80 x 45 mm
19 cm (7 1/2")

78-385-02
80 x 95 mm
18.5 cm (7 1/4")



78-387-25
Sauerbruch Retractor
127 x 38 mm
Overall Length 25.5 cm (10")

78-400-00
Set of Fig. 1 & Fig. 2

78-400-01
Fig. 1
28 x 20 mm-36 x 28 mm

78-400-02
Fig. 2
49 x 38 mm-63 x 49 mm

Retractors
Wundhaken, Wundhäkchen
Separadores
Ecarteurs
Divaricatori



Richardson Retractor

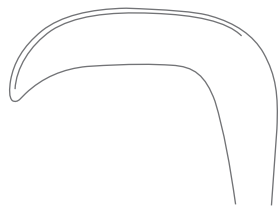

78-403-01
25 x 21 mm
23.5 cm (9 1/4")

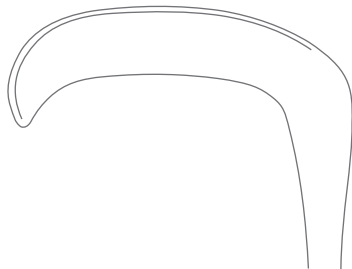

78-403-02
30 x 29 mm
24 cm (9 1/2")

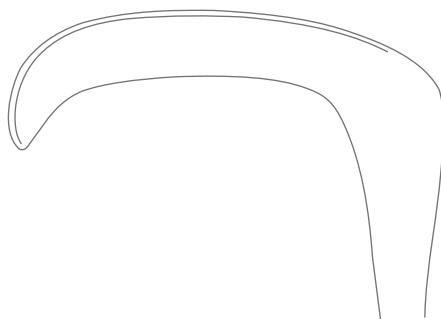

78-403-02
30 x 29 mm
24 cm (9 1/2")



78-405-24
Richardson Retractor
48 x 22 mm
Overall Length 24 cm (9 1/2")

Retractors
Wundhaken, Wundhäkchen
Separadores
Ecarteurs
Divaricatori



Kelly Retractor
Overall Length 26 cm (10 1/4")

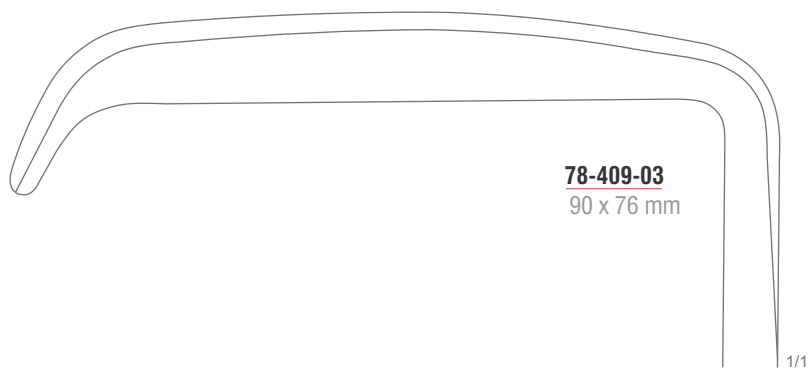
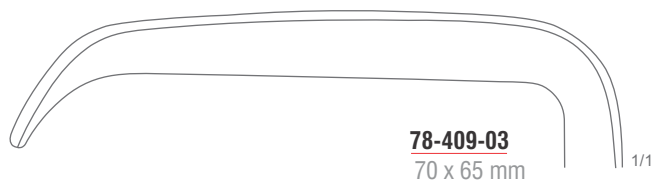
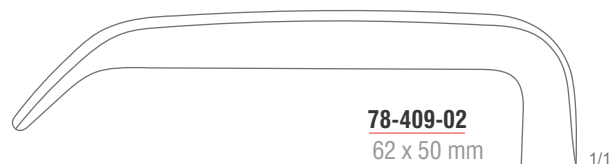
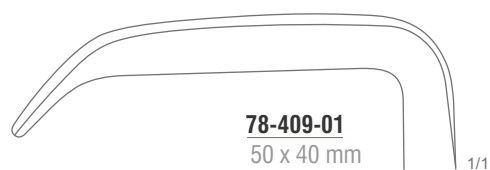

Retractors
Wundhaken, Wundhäkchen
Separadores
Ecarteurs
Divaricatori



78-413-21
Tuffier Retractor
58 x 64 mm
Overall Length 21.5 cm (8 ½")



Morris Retractor
Overall Length 24.5 cm (9 ¾")

78-415-01
70 x 40 mm

78-415-02
70 x 50 mm

78-415-03
70 x 65 mm

Retractors
Wundhaken, Wundhäkchen
Separadores
Ecarteurs
Divaricatori



78-416-01

32 x 51 mm, 38 x 51 mm

78-416-01

44 x 51 mm, 51 x 51 mm

78-416-01

64 x 51 mm, 38 x 51 mm

Morris Retractor

Double Ended

Overall Length 21.5 cm (8 ½")



78-417-20

Tud67-Edwards Retractor

55 x 47 mm

Overall Length 20.5 cm (8")



Retractors
Wundhaken, Wundhäkchen
Separadores
Ecarteurs
Divaricatori

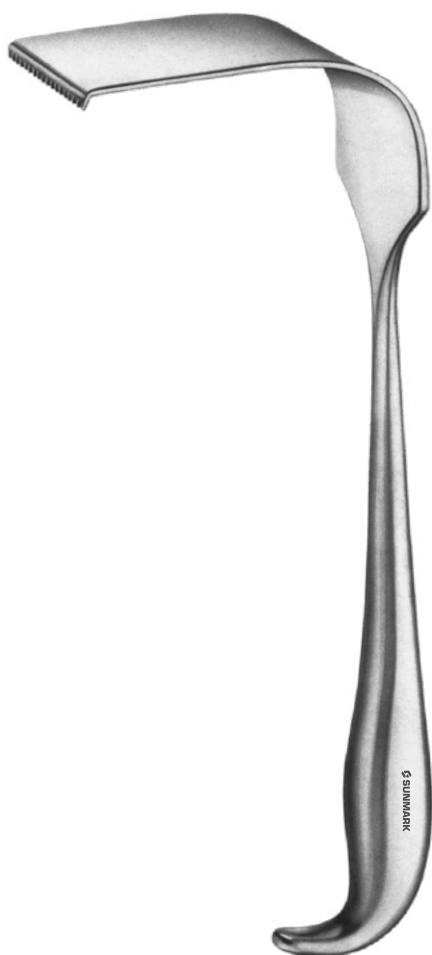

Meyerding Retractor



78-419-01
52 x 16 mm
23 cm (9")

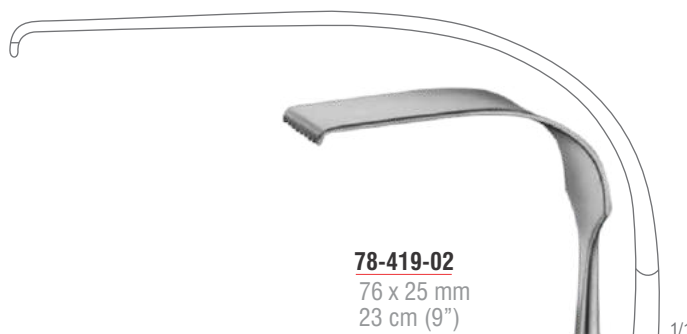

78-419-02
76 x 25 mm
23 cm (9")

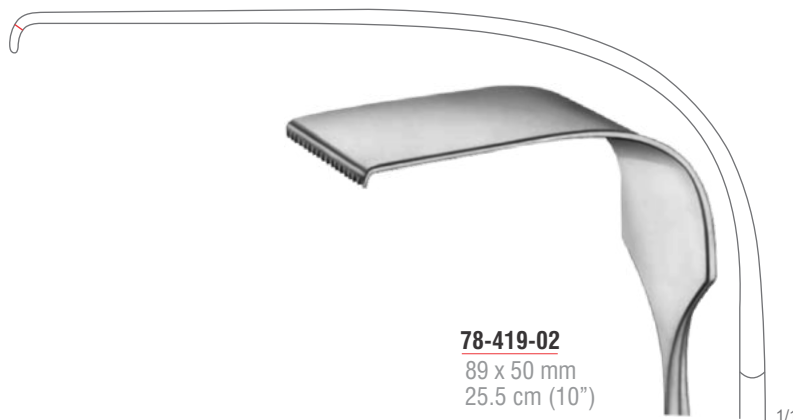

78-419-02
89 x 50 mm
25.5 cm (10")

Retractors
Wundhaken, Wundhäkchen
Separadores
Ecarteurs
Divaricatori



Doyen Retractor

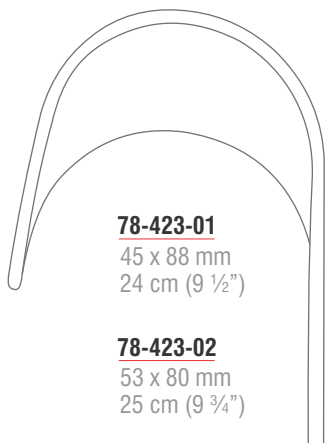

78-423-01
45 x 88 mm
24 cm (9 1/2")

78-423-02
53 x 80 mm
25 cm (9 3/4")

78-423-03
78 x 82 mm
25 cm (9 3/4")

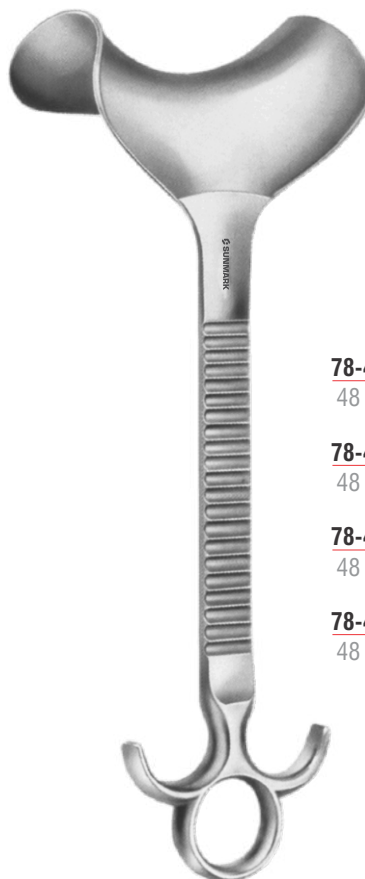

Doyen Retractor
Overall Length 28 cm (11")

78-431-01
48 x 90 mm

78-431-02
48 x 105 mm

78-431-03
48 x 120 mm

78-431-04
48 x 135 mm



78-387-25
Chain With Weight
For use with 78-431-01 to 78-431-04
Overall Length 79 cm (31")

Retractors
Wundhaken, Wundhäkchen
Separadores
Ecarteurs
Divaricatori

78

THORAX, CARDIOVASCULAR SURGERY



78-435-22
Kocher Retractor
73 x 25 mm
Overall Length 24 cm (9 1/2")



78-437-01
80 x 45 mm

78-437-02
80 x 55 mm

78-437-03
80 x 65 mm

Kocher Retractor
Overall Length 25 cm (9 3/4")

Retractors
Wundhaken, Wundhäkchen
Separadores
Ecarteurs
Divaricatori



Doyen-Style Retractor
Overall Length 26 cm (10 1/4")

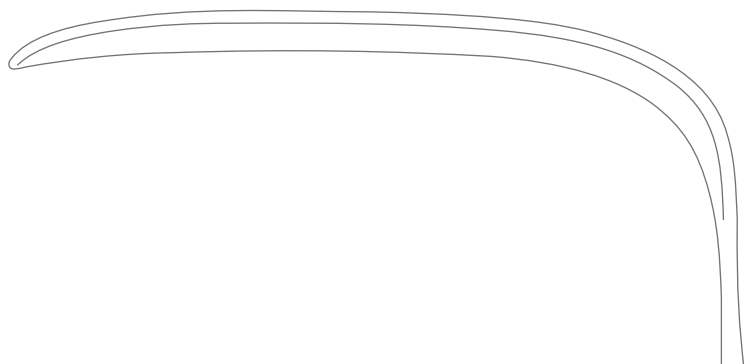

78-441-01
87 x 28 mm

1/1

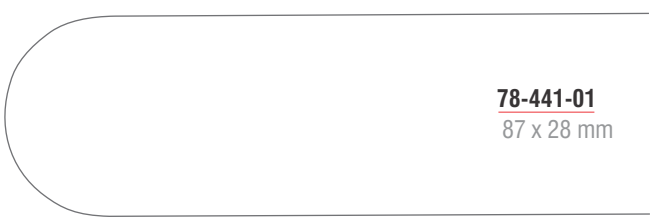

78-441-02
97 x 31 mm

1/1



78-441-03
117 x 52 mm

1/1

Retractors
Wundhaken, Wundhäkchen
Separadores
Ecarteurs
Divaricatori



Fritsch Retractor

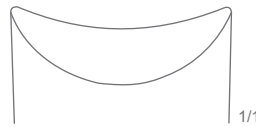

78-445-01
37 x 31 mm
23.5 cm (9 1/4")



78-445-02
38 x 40 mm
24 cm (9 1/2")

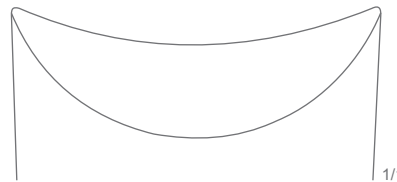

78-445-03
43 x 51 mm
25 cm (9 3/4")



78-445-04
49 x 61 mm
25 cm (9 3/4")

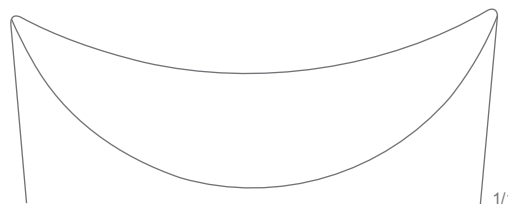

78-445-05
48 x 75 mm
25.5 cm (10")

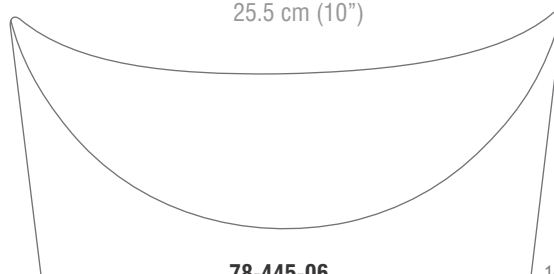

78-445-06
68 x 85 mm
26.5 cm (10 1/2")

Retractors
Wundhaken, Wundhäkchen
Separadores
Ecarteurs
Divaricatori



Hoesel Retractor
Overall Length 26 cm (10 1/4")

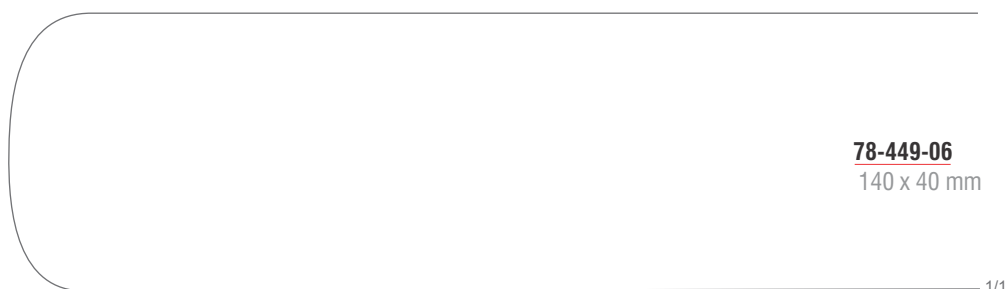
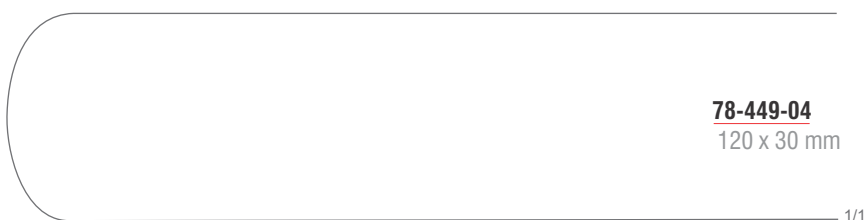
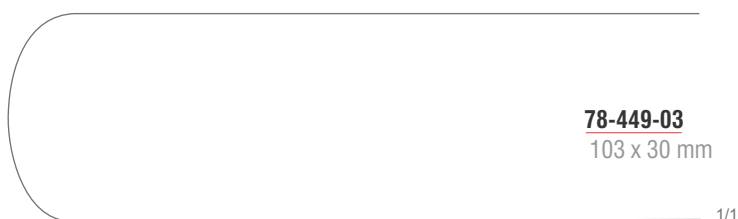
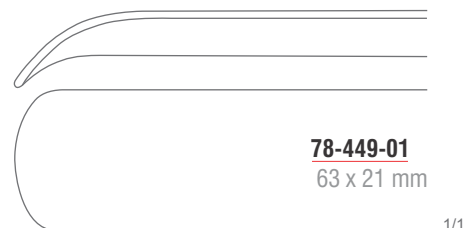

Retractors
Wundhaken, Wundhäkchen
Separadores
Ecarteurs
Divaricatori

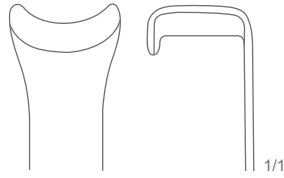

78-455-01
Fig. 1
16 x 15 mm



78-455-02
Fig. 2
23 x 13 mm

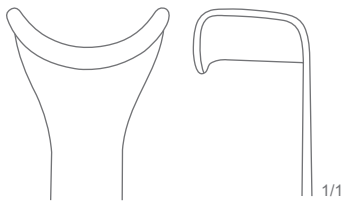

78-455-03
Fig. 3
24 x 16 mm



78-455-04
Fig. 4
27 x 13 mm

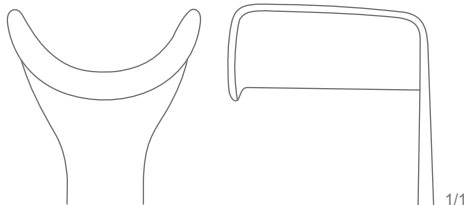

78-455-05
Fig. 5
27 x 27 mm

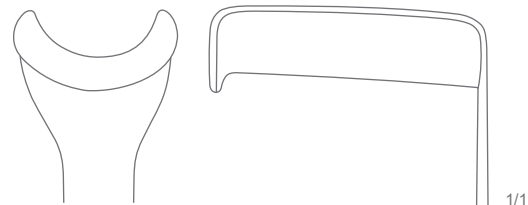

78-455-06
Fig. 6
25 x 39 mm

Ross Aorta Retractor
Flexible Shaft
Overall Length 25.5 cm (10")

Retractors
Wundhaken, Wundhäkchen
Separadores
Ecarteurs
Divaricatori



78-457-08
8.0 mm

78-457-11
11.0 mm

Cleland Valve Leaflet Retractor
Overall Length 26 cm (10 1/4")

Retractors
Wundhaken, Wundhäkchen
Separadores
Ecarteurs
Divaricatori

78

THORAX, CARDIOVASCULAR SURGERY

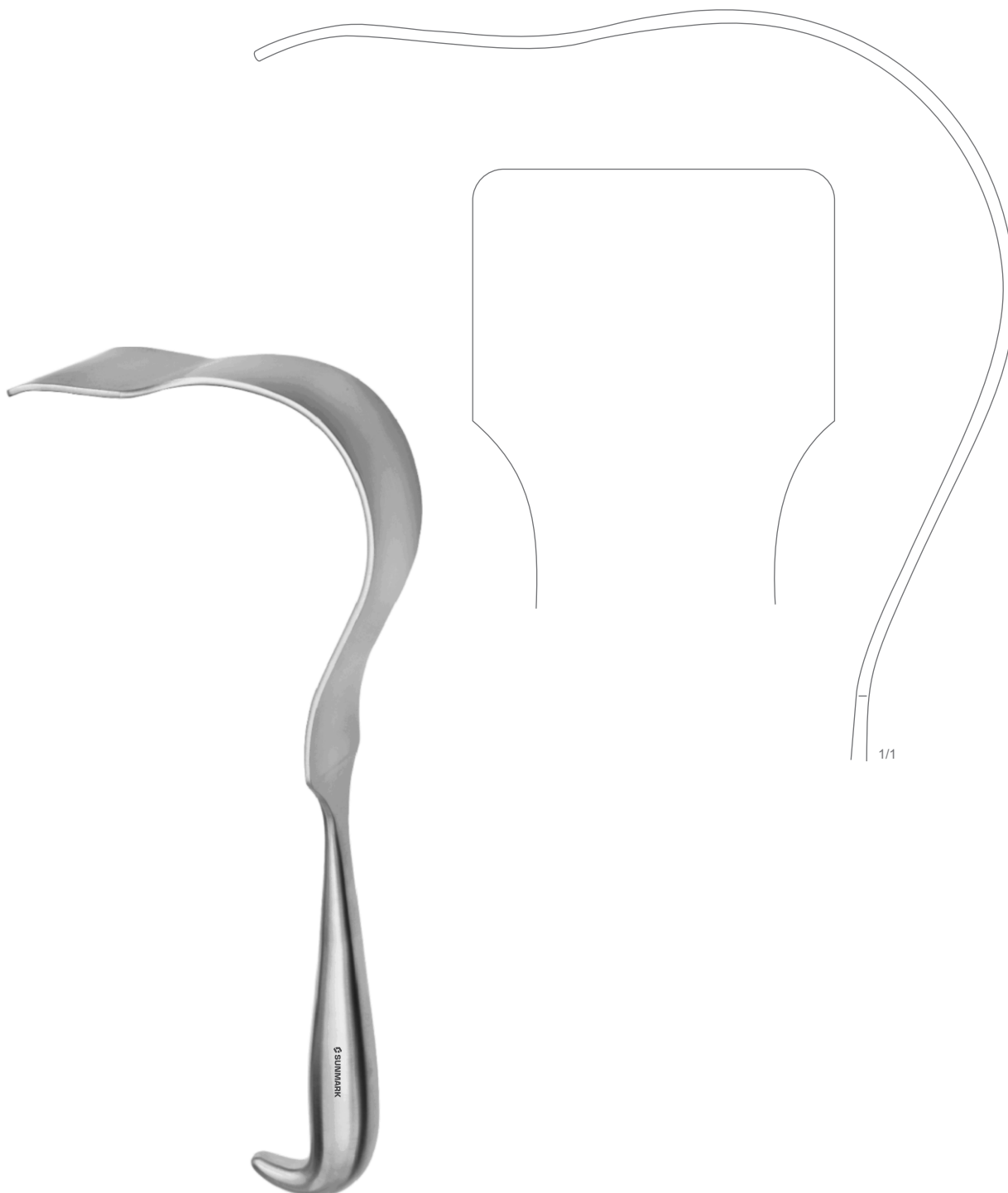

78-387-25
Polloson Retractor
Overall Length 29 cm (11 ½")

Retractors
Wundhaken, Wundhäkchen
Separadores
Ecarteurs
Divaricatori



78-461-27
Polloson Retractor
Overall Length 25.5 cm (10")

Retractors
Wundhaken, Wundhäkchen
Separadores
Ecarteurs
Divaricatori

78

THORAX, CARDIOVASCULAR SURGERY



78-463-24
Harrington-Baby Retractor
70 x 24 mm
Overall Length 25.5 cm (10")

Retractors
 Wundhaken, Wundhäkchen
 Separadores
 Ecarteurs
 Divaricatori

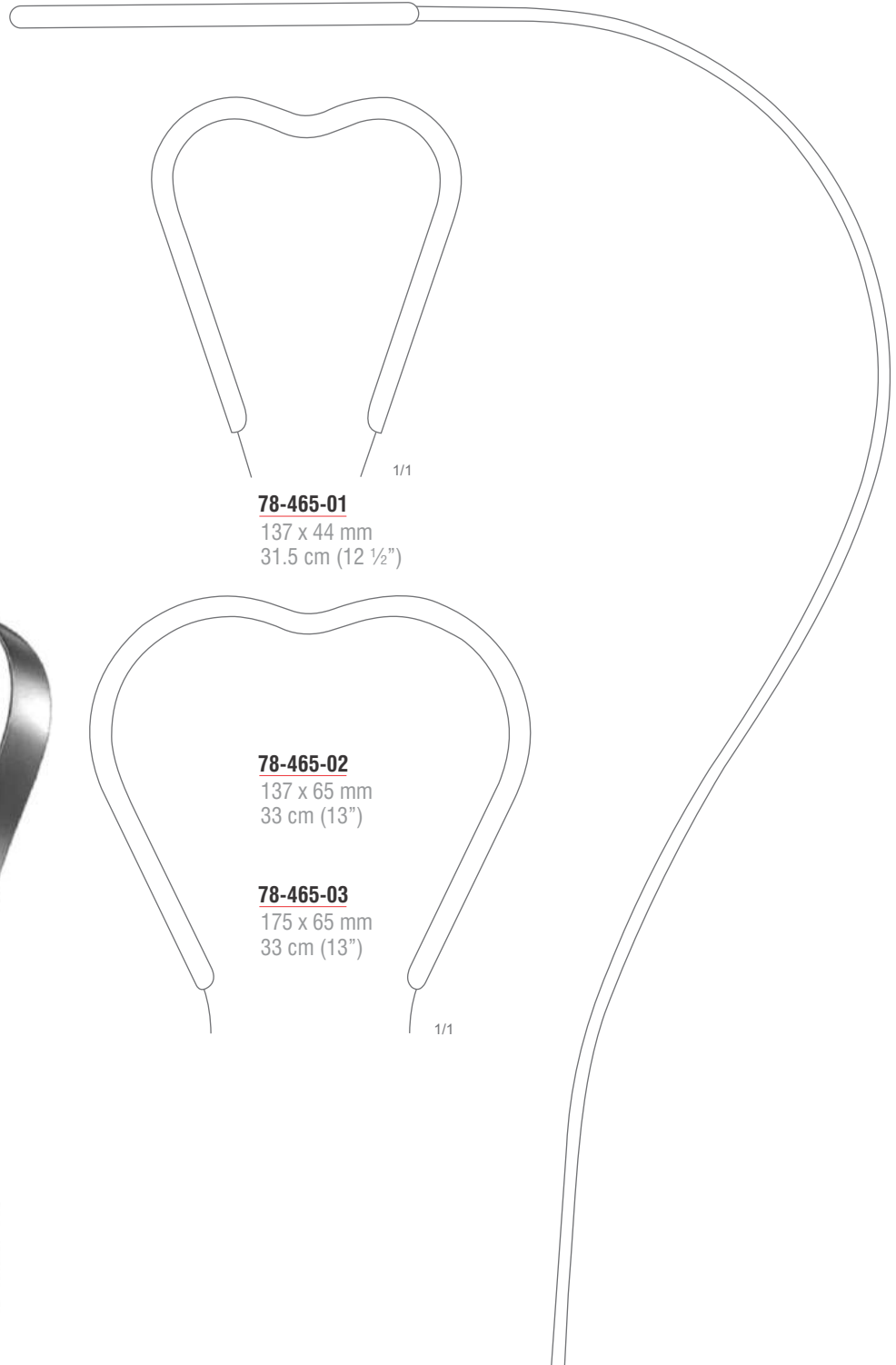

78-465-01
 137 x 44 mm
 31.5 cm (12 1/2")

78-465-02
 137 x 65 mm
 33 cm (13")

78-465-03
 175 x 65 mm
 33 cm (13")



Harrington-Baby Retractor

Retractors
Wundhaken, Wundhäkchen
Separadores
Ecarteurs
Divaricatori

78

THORAX, CARDIOVASCULAR SURGERY



78-467-44
Foss Gall Bladder Retractor
44 mm
Overall Length 25.5 cm (10")



78-471-01
Deaver Retractor
Fig. 1, 19 mm
Overall Length 18 cm (7")



78-471-02
Deaver Retractor
Fig. 2, 22 mm
Overall Length 21.5 cm (8 1/2")



78-471-03
Deaver Retractor
Fig. 3, 25 mm
Overall Length 25 cm (9 3/4")



78-471-04
Deaver Retractor
Fig. 4, 25 mm
Overall Length 31 cm (12 1/4")

Retractors
Wundhaken, Wundhäkchen
Separadores
Ecarteurs
Divaricatori



78-471-05
Deaver Retractor
Fig. 5, 25 mm
Overall Length 33 cm (13")

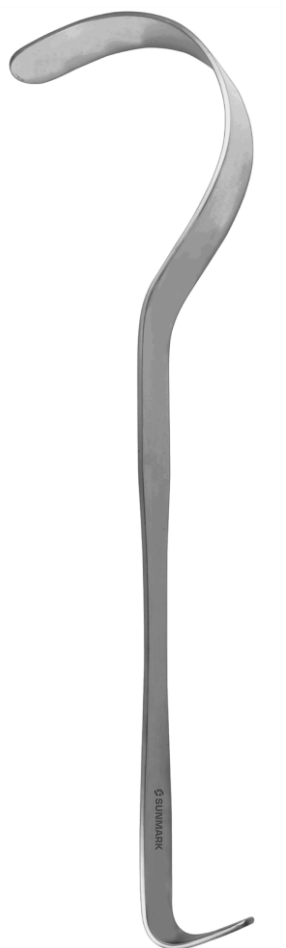

78-471-06
Deaver Retractor
Fig. 6, 25 mm
Overall Length 36 cm (14 1/4")



78-471-07
Deaver Retractor
Fig. 7, 25 mm
Overall Length 30 cm (11 3/4")



78-471-08
Deaver Retractor
Fig. 8, 50 mm
Overall Length 31 cm (12 1/4")

Retractors
Wundhaken, Wundhäkchen
Separadores
Ecarteurs
Divaricatori

THORAX, CARDIOVASCULAR SURGERY



78-471-09
Deaver Retractor
Fig. 9, 75 mm
Overall Length 31.5 cm (12 1/4")



Deaver Baby Retractor
Overall Length 17 cm (12 1/4")

78-471-08
8.0 mm

78-471-10
10.0 mm

78-473-10
10.0 mm

78-473-12
12.0 mm

Retractors
 Wundhaken, Wundhäkchen
 Separadores
 Ecarteurs
 Divaricatori



Deaver Retractor
 With Hollow Handle
 Overall Length 31.5 cm (12 1/2")

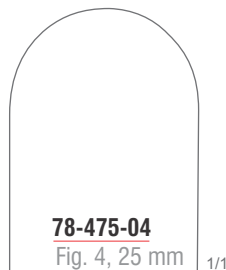

78-475-04
 Fig. 4, 25 mm 1/1

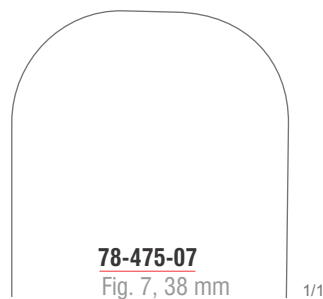

78-475-07
 Fig. 7, 38 mm 1/1

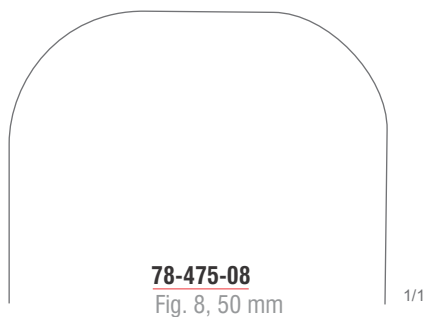

78-475-08
 Fig. 8, 50 mm 1/1

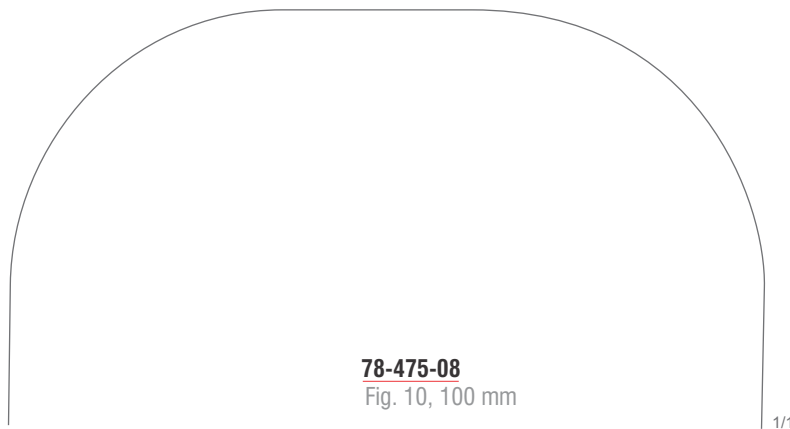

78-475-08
 Fig. 10, 100 mm 1/1

Retractors
Wundhaken, Wundhäkchen
Separadores
Ecarteurs
Divaricatori



78-479-01
45 mm
25.5 cm (10")

78-479-02
60 mm
27.5 cm (10 3/4")

Leriche Retractor

Retractors
Wundhaken, Wundhäkchen
Separadores
Ecarteurs
Divaricatori

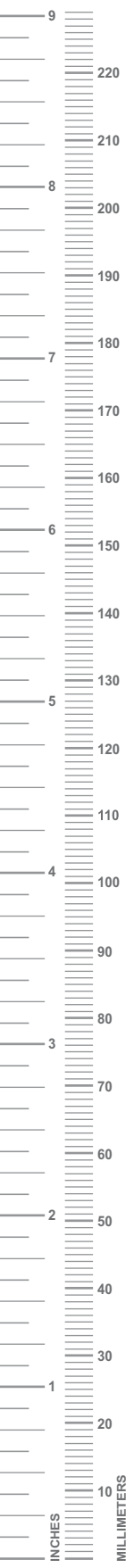

78-479-03
Kummel Retractor
46 mm
Overall Length 28.5 cm (11 1/4")



78-481-30
Koerte Retractor
46 mm
Overall Length 30 cm (11 3/4")

Retractors
Wundhaken, Wundhäkchen
Separadores
Ecarteurs
Divaricatori

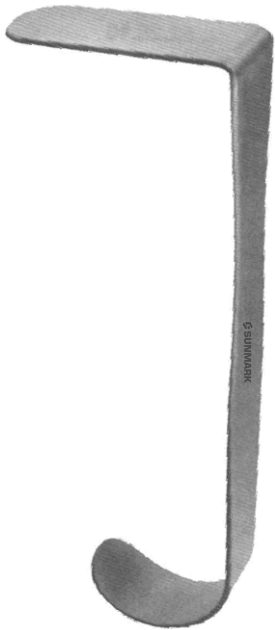

78-483-01
25 x 44 mm

78-483-02
28 x 73 mm

78-483-03
28 x 83 mm

Sauerbruch Retractor

Overall Length 26.5 cm (10 1/2")



78-485-01
Right
45 x 48 mm

78-485-02
Right, Serrated
45 x 48 mm



78-485-03
Left
25 x 46 mm



78-485-04
Right
45 x 30 mm

78-485-05
Right
45 x 35 mm

Cooley Retractor

Overall Length 25 cm (9 3/4")

Cooley Retractor

Overall Length 27 cm (10 3/4")

Cooley Retractor

Overall Length 25 cm (9 3/4")

THORAX, CARDIOVASCULAR SURGERY

Retractors
Wundhaken, Wundhäkchen
Separadores
Ecarteurs
Divaricatori



78-487-01
Right Small, 22 mm
18.5 cm (7 1/4")

78-487-02
Right Medium, 34 mm
19 cm (7 1/2")

78-487-03
Right Large, 47 mm
19 cm (7 1/2")

Cooley Mitral Valve Retractor

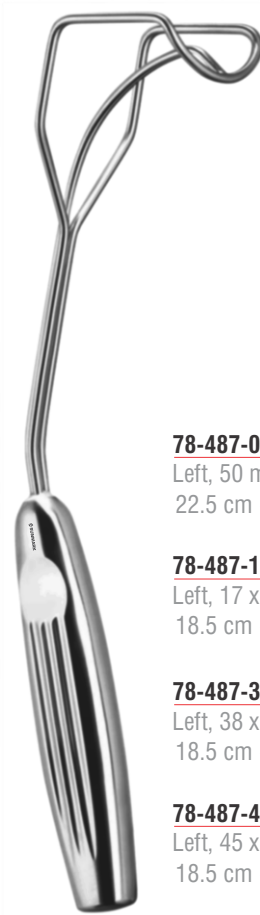

78-487-04
Left, 50 mm
22.5 cm (8 3/4")

78-487-17
Left, 17 x 19 mm
18.5 cm (7 1/4")

78-487-38
Left, 38 x 19 mm
18.5 cm (7 1/4")

78-487-45
Left, 45 x 22 mm
18.5 cm (7 1/4")

Cooley Mitral Valve Retractor



Borowski Aortic Valve Retractor
Overall Length 27 cm (10 3/4")

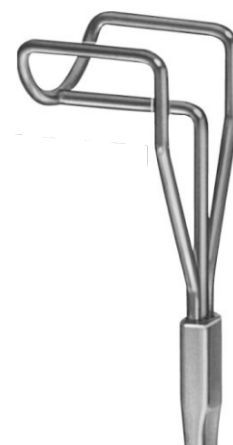

78-488-01
17 x 21 mm

78-488-02
16 x 23 mm

Retractors
Wundhaken, Wundhäkchen
Separadores
Ecarteurs
Divaricatori



Mikulicz Liver Retractor
Overall Length 25 cm (9 3/4")

Retractors
Wundhaken, Wundhäkchen
Separadores
Ecarteurs
Divaricatori



78-491-26
Mikulicz Retractor
90 x 55 mm
Overall Length 26 cm (10 1/4")

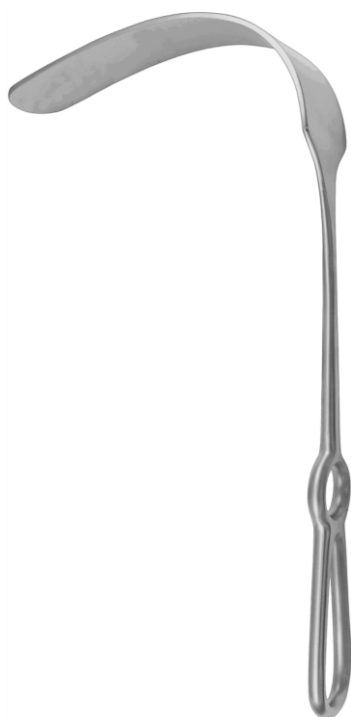

Kelly Retractor
Overall Length 27.5 cm (10 3/4")



78-495-01
205 x 38



78-495-02
205 x 57

Retractors
Wundhaken, Wundhäkchen
Separadores
Ecarteurs
Divaricatori



78-511-28
Kummel Abdominal Spatula
45 mm
Overall Length 31 cm (12 1/4")



Kader Abdominal Spatula
Overall Length 28 cm (11")

- 78-515-20**
20 mm
- 78-515-30**
30 mm
- 78-515-40**
40 mm



Abdominal Spatula
Overall Length 41 cm (16")

- 78-520-30**
30 mm
- 78-520-40**
40 mm
- 78-520-50**
50 mm
- 78-520-60**
60 mm
- 78-520-70**
70 mm

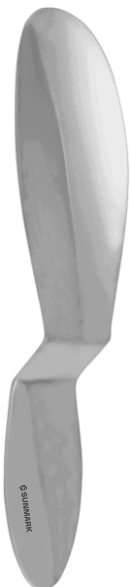

78-523-28
Reverdin Abdominal Spatula
63 x 45 mm
Overall Length 28.5 cm (11 1/4")



Abdominal Spatula
Overall Length 33 cm (13")

- 78-530-20**
20 mm
- 78-530-25**
25 mm
- 78-530-30**
30 mm
- 78-530-40**
40 mm
- 78-530-50**
50 mm

THORAX, CARDIOVASCULAR SURGERY

Retractors
 Wundhaken, Wundhäkchen
 Separadores
 Ecarteurs
 Divaricatori



78-534-20
Tuffier Abdominal Spatula
 Tapered, 16 x 25 mm
 Overall Length 20 cm (8")



Heberer Abdominal Spatula
 Tapered

78-536-01

25 x 30 mm
 28 cm (11")

78-536-02

37 x 45 mm
 30 cm (11 3/4")

78-536-03

40 x 50 mm
 30.5 cm (12")



78-540-06

6.5 mm

78-540-09

9.5 mm

78-540-13

13 mm

78-540-16

16 mm

78-540-19

19 mm

78-540-25

25 mm

Martin Abdominal Spatula
 Malleable, Very Soft
 Overall Length 20 cm (8")

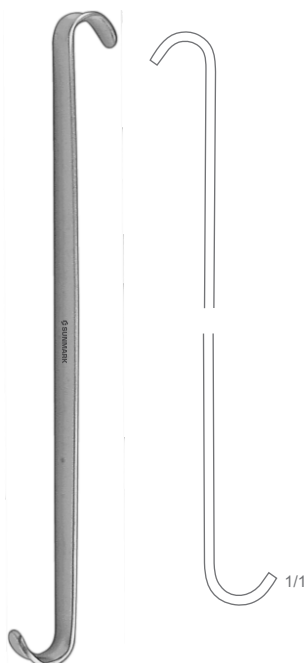

78-557-14
Roux-Mini Retractor
 6 x 7 mm - 7 x 8 mm
 Overall Length 14.5 cm (5 3/4")

Retractors
Wundhaken, Wundhäkchen
Separadores
Ecarteurs
Divaricatori

78

THORAX, CARDIOVASCULAR SURGERY

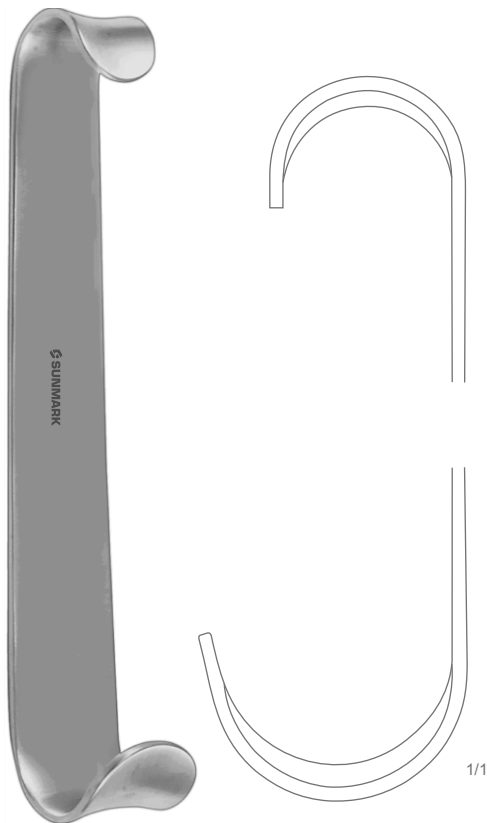

78-559-12

Roux-Baby Retractor

17 x 17 mm - 24 x 21 mm
Overall Length 12.5 cm (5")

Retractors
 Wundhaken, Wundhäkchen
 Separadores
 Ecarteurs
 Divaricatori

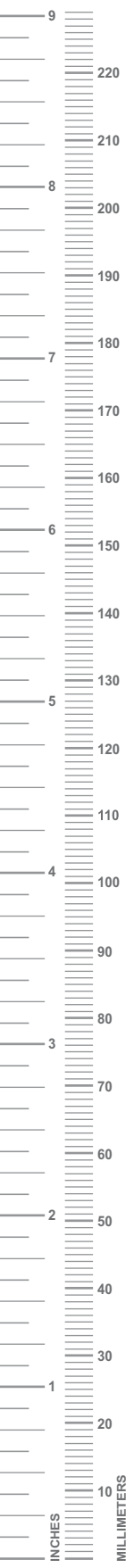

78-561-00
Roux Retractor
 Set (Fig. 1,2,3)

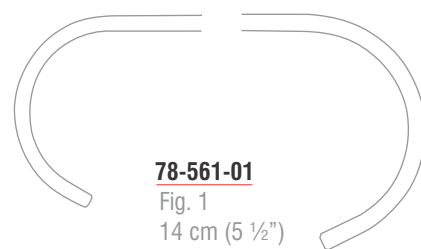
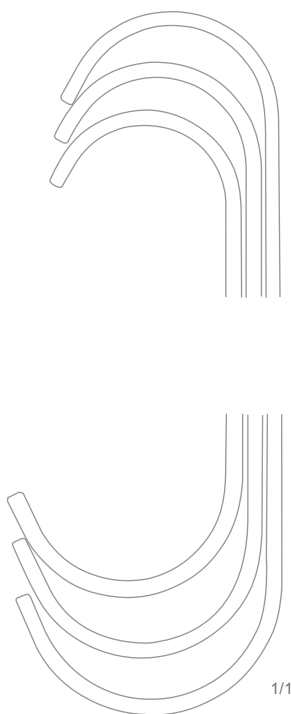

78-561-01
 Fig. 1
 14 cm (5 1/2")

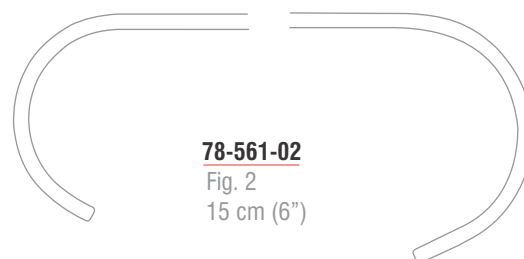

78-561-02
 Fig. 2
 15 cm (6")

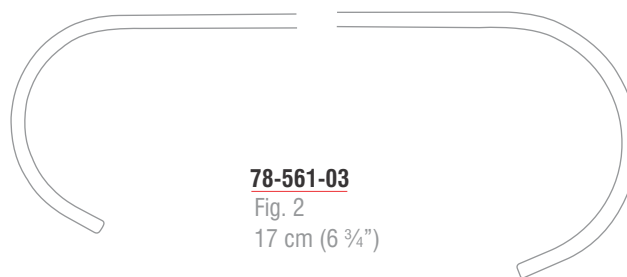

78-561-03
 Fig. 2
 17 cm (6 3/4")

Retractors
Wundhaken, Wundhäkchen
Separadores
Ecarteurs
Divaricatori



78-563-00
Collin Retractor Set
Fig. 1
17 x 14 mm - 28 x 16 mm
Fig. 2
21 x 14 mm - 32 x 16 mm
Overall Length 15 cm (6")

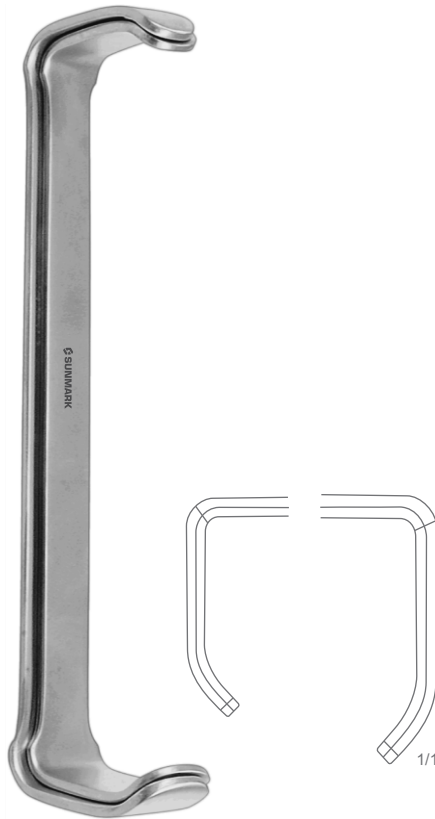

78-565-00
Farabeuf Retractor Set
Fig. 1
26 x 10 mm - 30 x 13 mm
Fig. 2
30 x 10 mm - 34 x 13 mm
Overall Length 12 cm (4 3/4")

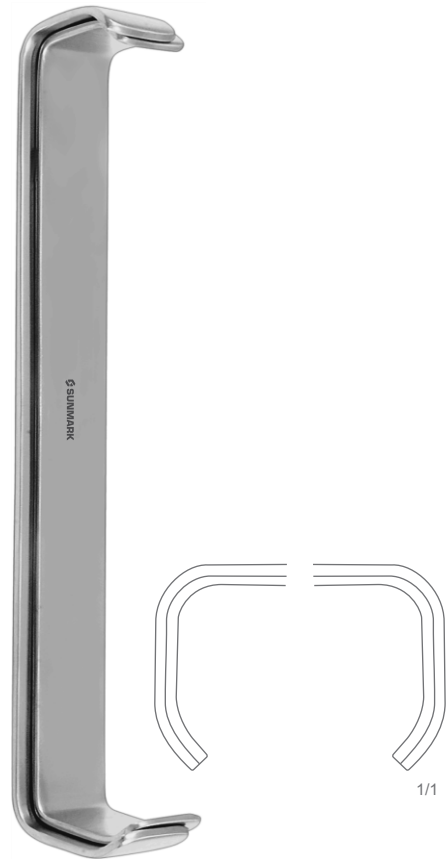

78-567-00
Farabeuf Retractor Set
Fig. 1
23 x 16 mm - 26 x 16 mm
Fig. 2
27 x 16 mm - 30 x 16 mm
Overall Length 15 cm (6")

Retractors
Wundhaken, Wundhäkchen
Separadores
Ecarteurs
Divaricatori

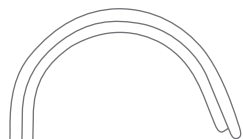

78-571-01

Fig. 1

19 x 15 mm - 19 x 15 mm, 22 x 15 mm - 22 x 15 mm
13.5 cm (5 1/4")



78-571-01

Fig. 1

26 x 25 mm - 27 x 25 mm, 29 x 25 mm - 27 x 25 mm
17.5 cm (7")

Parker Retractor Set

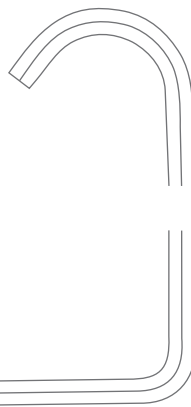

1/1

78-573-16

Parker-Mott Retractor Set

21 x 24 mm - 68 x 24 mm, 25 x 24 mm - 72 x 24 mm
Overall Length 16 cm (6 1/4")

Retractors
 Wundhaken, Wundhäkchen
 Separadores
 Ecarteurs
 Divaricatori

THORAX, CARDIOVASCULAR SURGERY

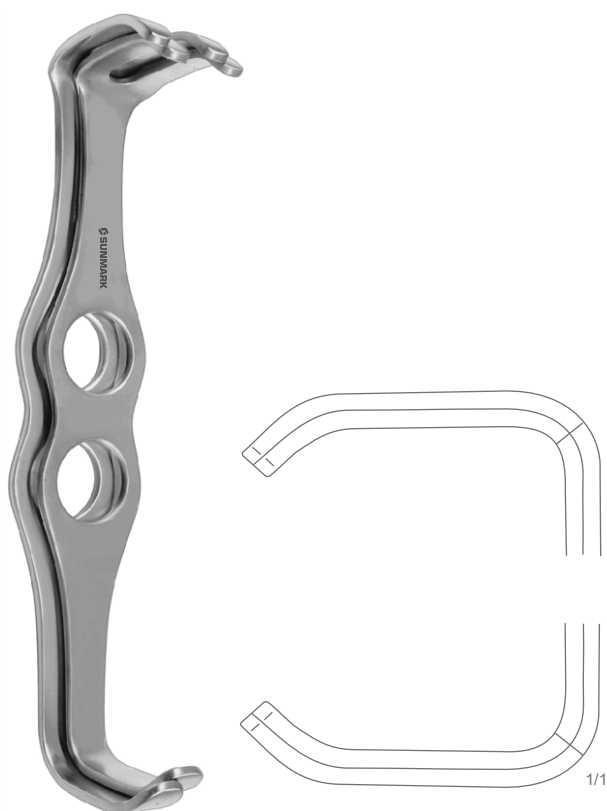

78-577-20

Mathieu Retractor Set

Fig. 1

42 x 13 mm - 42 x 26 mm

Fig. 2

47 x 13 mm - 46 x 26 mm

Overall Length 20 cm (8")

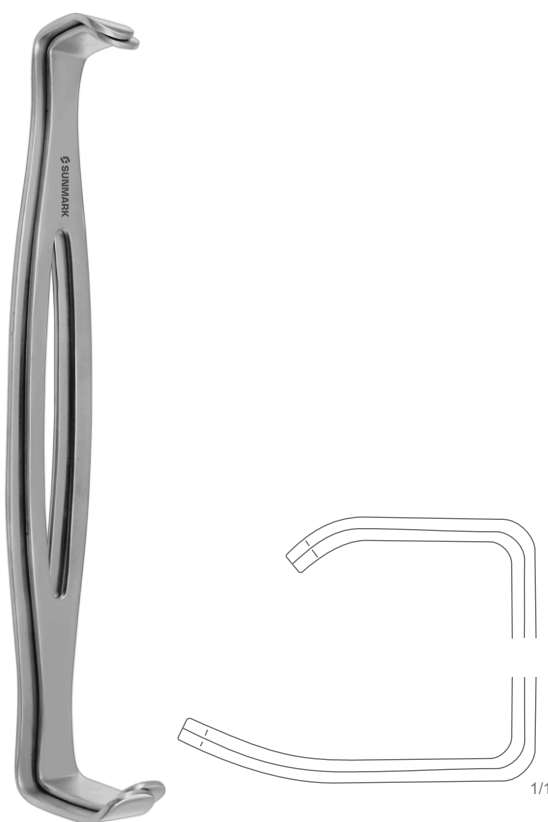

78-579-21

Parker-Langenbeck (US Army) Retractor

Fig. 1

21 x 15 mm - 40 x 15 mm

Fig. 2

25 x 15 mm - 45 x 15 mm

Overall Length 21.5 cm (8 ½")

78-579-21 T

Parker-Langenbeck (US Army) Retractor

Fig. 1

21 x 15 mm - 40 x 15 mm

Fig. 2

25 x 15 mm - 45 x 15 mm

Overall Length 21.5 cm (8 ½")



Retractors
Wundhaken, Wundhäkchen
Separadores
Ecarteurs
Divaricatori



78-581-16
Hajek Retractor
30 x 18 mm - 25 x 10 mm
Overall Length 16.5 cm (6 1/2")



Lane Retractor
Overall Length 23 cm (9")

78-583-01
30 x 13 mm - 35 x 19 mm

78-583-02
30 x 25 mm - 35 x 32 mm



78-591-17
Czerny Retractor
38 x 22 mm - 38 x 22 mm
Overall Length 17.5 cm (7")

Retractors
Wundhaken, Wundhäkchen
Separadores
Ecarteurs
Divaricatori

THORAX, CARDIOVASCULAR SURGERY



78-593-19
Goelet Retractor
40 x 40 mm - 30 x 30 mm
Overall Length 19 cm (7 ½")



78-595-01
16 mm
19 cm (7 ½")

78-595-02
20 mm
19 cm (7 ½")

78-595-03
25 mm
20 cm (8")

Cranny-Ryall Retractor



78-661-30
Bose Fat Spreader for Coronary Surgery
Overall Length 3 cm (1 ¼")



78-663-40
4 cm (1 ½")

78-663-55
5.5 cm (2 ¼")

Fat Spreader for Coronary Surgery

Retractors
Wundhaken, Wundhäkchen
Separadores
Ecarteurs
Divaricatori



78-665-03

3 Toothed Blades
8.5 cm (3 1/2")

78-665-04

4 Toothed Blades
11.5 cm (4 1/2")

Spring Wire Retractor

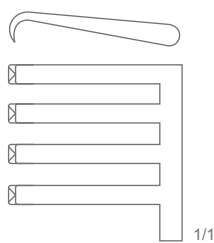

78-686-20

4 x 4 Sharp Prongs

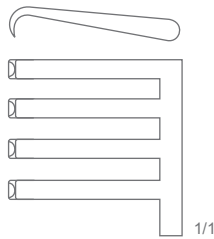

78-687-20

4 x 4 Blunt Prongs

Anderson-Adson Self Retaining Retractor
Overall Length 20 cm (8")



78-689-21

4 x 5 Blunt Prongs

Overall Length 21.5 cm (8 1/2")

Retractors
Wundhaken, Wundhäkchen
Separadores
Ecarteurs
Divaricatori

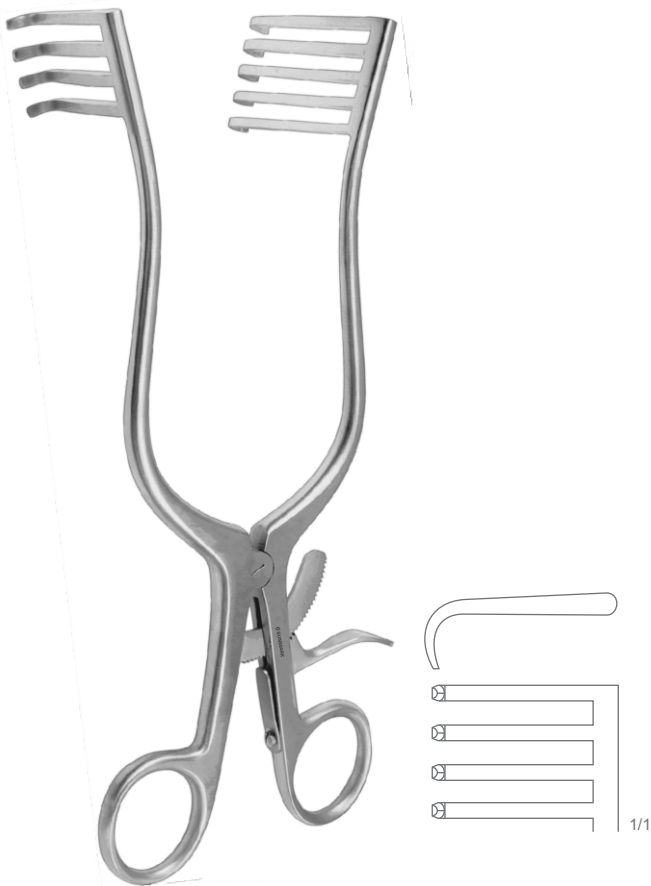

78-691-22
Norfolk-Norwich Self Retaining Retractor
4 x 5 Blunt Prongs
Overall Length 22 cm (8 3/4")

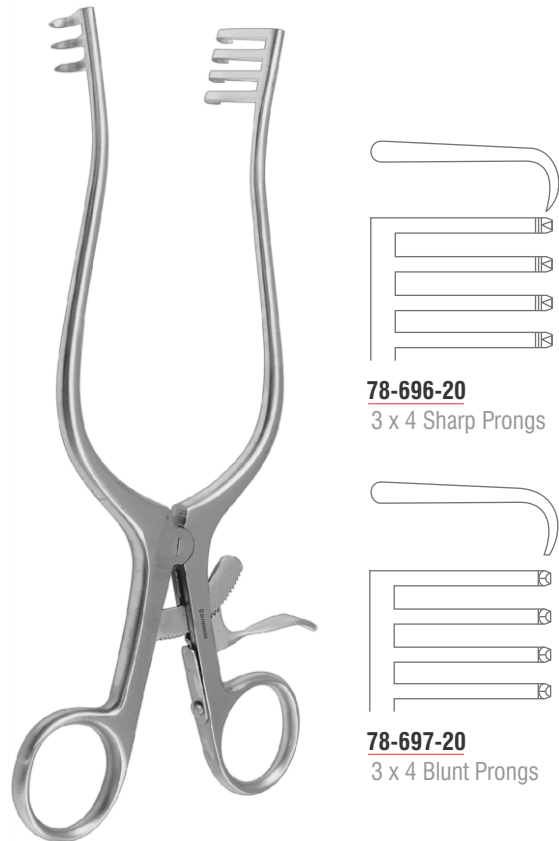

78-696-20
3 x 4 Sharp Prongs

78-697-20
3 x 4 Blunt Prongs

Weitlaner Self Retaining Retractor
Overall Length 20 cm (8")

Retractors
Wundhaken, Wundhäkchen
Separadores
Ecarteurs
Divaricatori



Adson Self Retaining Retractor

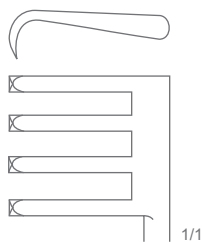

78-700-26
3 x 4 Sharp Prongs
26 cm (10 1/4")

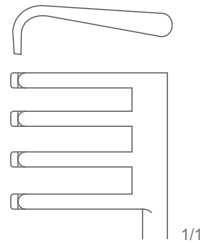

78-701-26
3 x 4 Blunt Prongs
26 cm (10 1/4")

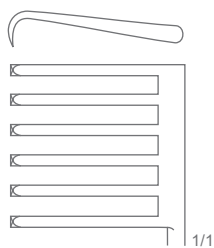

78-700-26
6 x 6 Sharp Prongs
29 cm (11 1/2")

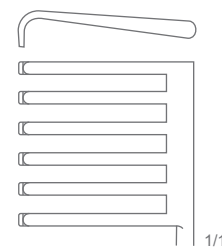

78-701-26
6 x 6 Blunt Prongs
29 cm (11 1/2")



Weitlaner Self Retaining Retractor
Overall Length 11 cm (4 1/4")

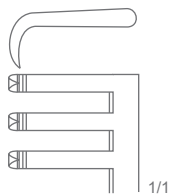

78-710-11
2 x 3 Sharp Prongs

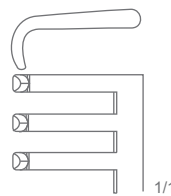

78-711-11
2 x 3 Blunt Prongs



Retractors
Wundhaken, Wundhäkchen
Separadores
Ecarteurs
Divaricatori

THORAX, CARDIOVASCULAR SURGERY

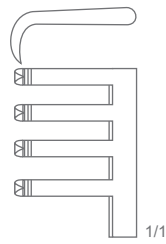
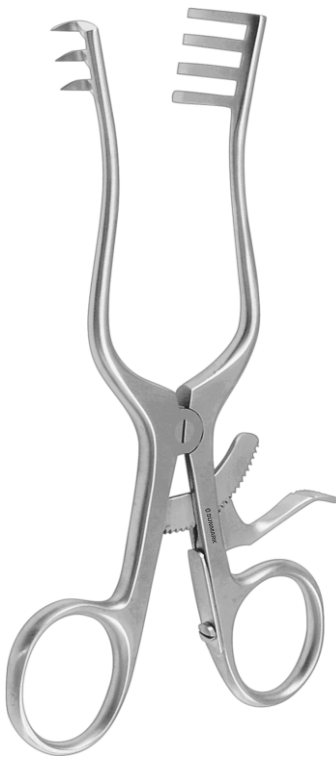

78-712-13
3 x 4 Sharp Prongs
13.5 cm (5 1/4")

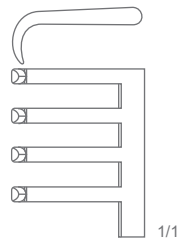

78-713-13
3 x 4 Sharp Prongs
13.5 cm (5 1/4")

78-712-16
3 x 4 Sharp Prongs
16 cm (6 1/4")

78-713-16
3 x 4 Sharp Prongs
16 cm (6 1/4")

Weitlaner Self Retaining Retractor

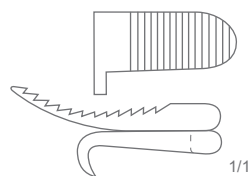

78-721-01
Right

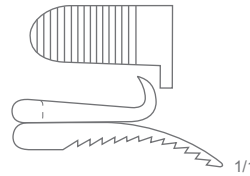

78-721-02
Left

Perkins Self Retaining Retractor
Overall Length 13 cm (5")

Retractors
Wundhaken, Wundhäkchen
Separadores
Ecarteurs
Divaricatori

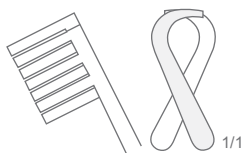

78-725-14
Jefferson Self Retaining Retractor
2 x 3 Blunt Prongs
Overall Length 14 cm (5 1/2")

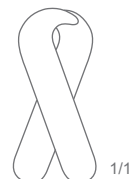

78-728-14
Mollison Self Retaining Retractor
2 x 2 Sharp Prongs
Overall Length 14 cm (5 1/2")

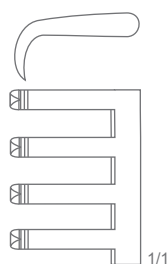

78-730-15
Mollison Self Retaining Retractor
4 x 4 Blunt Prongs
Overall Length 15.5 cm (6")

Retractors
Wundhaken, Wundhäkchen
Separadores
Ecarteurs
Divaricatori

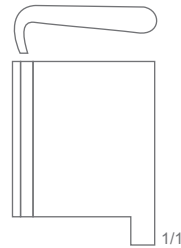

78-739-13
Weitlaner-Baby Self Retaining Retractor
Blunt
Overall Length 13.5 cm (5 1/4")

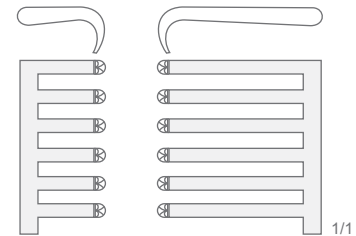

78-770-01
6 x 6 Sharp Long Prongs
Teeth on Left Side

78-770-02
6 x 6 Sharp Long Prongs
Teeth on Right Side

Martin Self Retaining Retractor
Overall Length 28.5 cm (11 1/4")

CARDIOVASCULAR INSTRUMENTS CATALOGUE

Cardiovascular Instruments ◆ Herz - Kreislauf - Instrumente ◆ Instrumentos cardiovasculares
Instruments cardiovasculaires ◆ Strumenti cardiovascolari



SUNMARK
I N S T R U M E N T S

Mark Of Quality

+92 (331) 661 9646

www.sunmarkinstruments.com

sales@sunmarkinstruments.com

Small Industrial Estate Sialkot-51310 Punjab Pakistan

